

Ezekiel Nyangeri Nyanchaga

History of Water Supply and Governance in Kenya

(1895–2005)

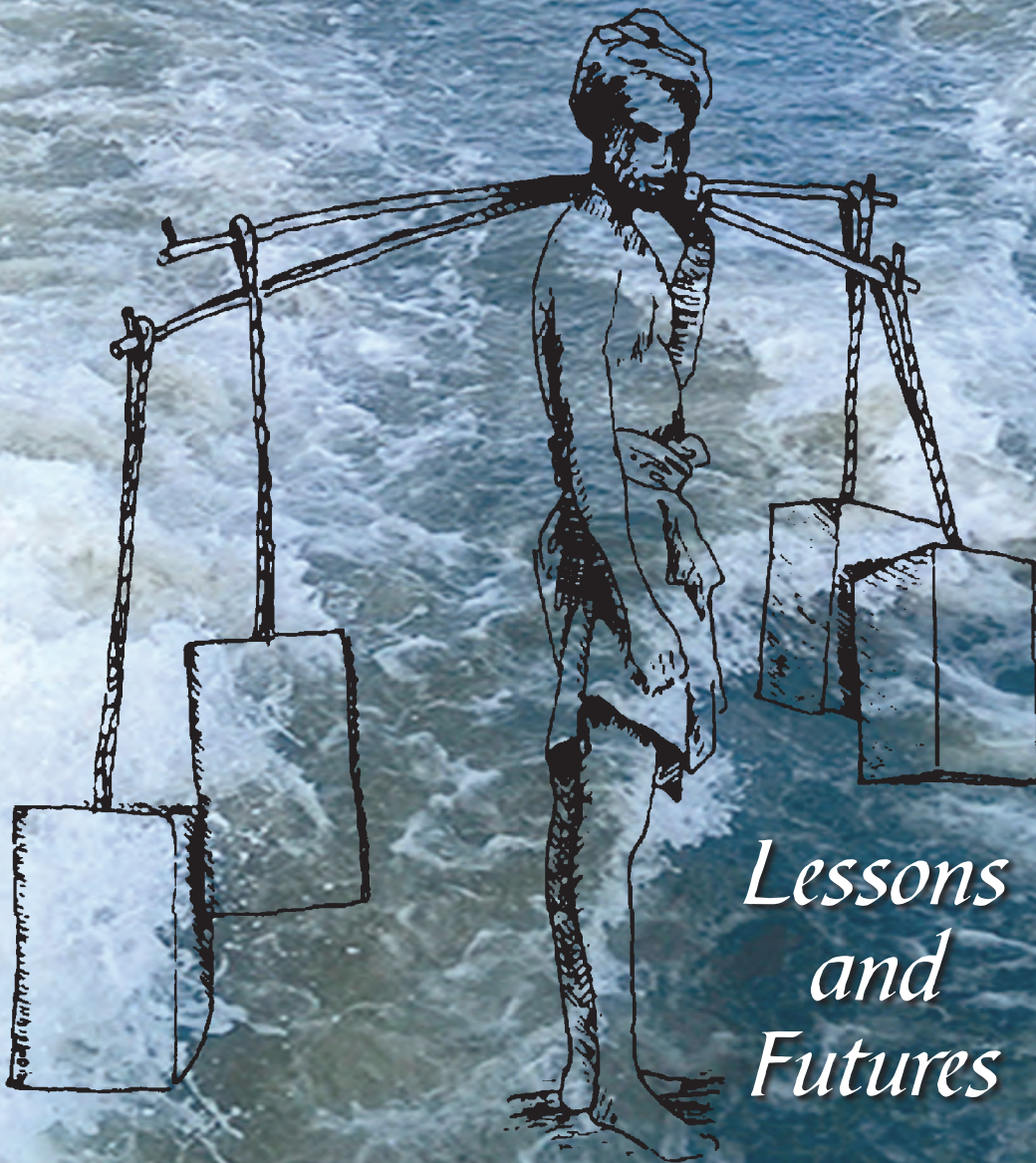

*Lessons
and
Futures*

HISTORY OF WATER SUPPLY AND GOVERNANCE
IN KENYA (1895–2005)

Ezekiel Nyangeri Nyanchaga

HISTORY OF WATER SUPPLY AND GOVERNANCE
IN KENYA (1895–2005)

Lessons and Futures



Publisher  TAMPERE
UNIVERSITY
PRESS

Copyright ©2016 Tampere University Press and the Author



Distribution:
verkkokauppa@juvenesprint.fi
<https://verkkokauppa.juvenes.fi>

Cover and page design
by Maaret Kihlakaski

ISBN 978-952-03-0059-3
ISBN 978-952-03-0060-9 (pdf)

Tampereen Yliopistopaino Oy – Juvenes Print
Tampere 2016



Contents

FOREWORD	9
PREFACE AND ACKNOWLEDGEMENTS.....	11
ACRONYMS AND ABBREVIATIONS.....	16
DEFINITION OF TERMS	19
CHAPTER ONE.....	21
1.0 Introduction	21
1.1 Physical Conditions	24
1.2 Population	28
CHAPTER TWO.....	31
2.0 Administration and Management of Water Services	31
2.1 General Overview.....	31
2.2 Imperial British East Africa Company (1888–1895).....	31
2.3 British East Africa Protectorate (1895–1920).....	32
2.4 Kenya as Protectorate and Colony (1920–1963)	35
2.5 Independent Kenya, Water under Ministry of Agriculture (1963–1974)...	42
2.6 Water Services under Ministry of Water Development (1974–1986).....	51
2.7 Water Services under Ministry of Water Development (1987–1999).....	56
2.8 Actualisation of the Water Sector Reforms (2000–2003).....	60
CHAPTER THREE	66
3.0 Development and Management of Water Services	66
3.1 Sources of Water Supplies.....	66
3.1.1 Water Condensing Plant.....	66
3.1.2 Rainwater Harvesting	67
3.1.3 Ground Water Supply.....	70
3.1.4 Springs, Streams and Rivers	71
3.1.5 Pans and Dams	72
3.2 Water Conveyance Systems	80
3.2.1 Furrows	80
3.2.2 Water Carriers	81
3.2.3 Pumping System.....	83
3.2.4 Kiosk System.....	85

3.3 Water Supplies Projects	85
3.3.1 Major Urban Water Supplies.....	87
3.3.2.1 Coast Province Water Supplies	150
3.3.2.2 Nyanza Province Water Supplies	176
3.3.2.3 Rift Valley Province Water Supplies	187
3.3.2.4 North Eastern Province Water Supplies.....	213
3.3.2.5 Eastern Province Water Supplies	229
3.3.2.6 Central Province Water Supplies	296
3.3.2.7 Western Province Water Supplies	317
3.3.2 Rural Water Supplies	334
3.4 Private Sector Involvement	423
3.4.1 Private Companies	423
3.4.2 Commercialisation of Water and Sanitation Services	424
3.5 Bilateral Assistance Programmes	427
3.5.1 UNICEF/WHO	428
3.5.2 Kenya-Finland Western Water Supply Program	444
3.5.3 Rural Domestic Water Supply and Sanitation Programme.....	448
3.6 Donor Interest.....	457
3.6.1 Dutch Support	457
3.6.2 Norwegian Support	457
3.6.3 Canadian Support.....	459
3.6.4 Swedish Support 3.6.5 Danish Support	459
3.6.5 Danish Support.....	463
3.6.6 Other Support	464
3.6.7 Taking/Handing over of Water Supplies.....	466
3.7 Water Tariffs.....	471
3.7.1 Origin and Progression	471
3.7.2 Water Metre problems.....	473
3.7.3 Challenges in Water Pricing.....	473
3.7.4 Tariff and Metering Policy	476
3.7.5 Government Policy on Pricing	480
3.7.6 Indirect costs of informal water supplies	482
3.7.7 Water conflict.....	482
3.8 Water Policy and Legislation	489
3.8.1 Water Policy	489
3.8.2 Water Legislation	523
3.9 Governance of the Water Sector.....	533
3.10 Access to Water and Sanitation Services	538

CHAPTER FOUR.....	540
4.0 Drivers of Water Supply Services	540
4.1 Socio-Economic Development	544
4.2 Population and Urbanisation	553
4.3 Changing Management Practices.....	556
4.4 Type of Development and Globalisation	557
4.5 Technological Advancement	560
CHAPTER FIVE.....	561
5.0 The Future of Water Services.....	561
5.1 Overview of stages of the Water Development	563
5.1.1 Quantitative Supply-Side Policies and Water Transfers.....	564
5.1.2 From Quantitative to Qualitative Supply-Side Policies	564
5.2 Current Challenges.....	565
5.2.1 Water Supplies	566
5.2.2 Available Water Options.....	567
5.3 Water and the Economy.....	576
5.4 Legislation and Policy	577
5.4.1 Hierarchy of Laws in Kenya.....	577
5.4.2 Water Act 2002	578
5.5 Information Dissemination.....	579
5.6 Commercialisation of Water Services	580
5.7 Institutional Framework.....	581
5.8 Effective Governance	584
5.9 Sustainability of Water Services.....	588
5.9.1 Economic: Capital maintenance and replenishment.....	589
5.9.2 Environment: New investments	589
5.9.3 Payment for Sustainability Costs	594
5.9.4 Cost Recovery and Subsidies	596
5.9.5 Long-term Effect of Subsidies.....	597
5.10 Are we facing a social reverse salient?.....	597
5.11 Way Forward	599
5.11.1 A market-based approach	601
5.11.2 A rights-based approach to water	607
CHAPTER SIX.....	609
6.0 Conclusion	609
CHAPTER SEVEN	613
7.0 Appendices.....	613

FOREWORD

Kenya has endorsed the principles and goals set at major international water declarations. The historic background of Kenya's water sector is multifaceted and long-standing. In this "*History of Water Supply and Governance in Kenya (1895-2005)*" Professor Ezekiel Nyangeri Nyanchaga covers the topic comprehensively and in a most interesting way. The background information is based on his extensive review of several studies and archived documents as well as long-time observations of numerous project operations. As a result, this historic information of the water sector is complete and useful; it was already long overdue.

The development of the water sector in Kenya dates back to the institutions established in the colonial era in the late 1890s. After independence in 1963, the new Kenyan government created ambitious development programs under the newly established sectoral ministries. Later on, these programs received further technical and financial support from external development aid agencies such as the World Bank, WHO, UNICEF and a large number of bilateral organizations.

This book traces back the legal, policy and institutional development over time from the initial customary water institutions to the year 2005. It addresses various stages of institutional development as well as a large number of water sector projects extensively and in detail. In a unique revelation, this book observes that privatisation, commercialisation, asset development, asset ownership, the operator and other modern concepts are just new words used to refer to old ideas.

These create an environment for innovation and the presence of the great variety of water resources. It explores the evolution of water supply in both urban and rural areas uncovering the first water supply, currently in use, and use of hand dug wells and protected springs by various rural communities. This book provides an

interesting description of these schemes and experiences from their operations that will immensely benefit sector professionals, students and policy makers.

This book also discusses the current situation analysing key achievements so far in water supply coverage, operation and financing. On this basis an assessment of the overall sustainability is attempted. Further, some relevant key indicators of achievements are reviewed. Despite the rapid population growth in Kenya, the sector has been able to cope with the increasing demand for water services reasonably well to ensure that the portion of population served has steadily increased, even though the work must continue.

This book discusses widely about drivers of water supply and presents challenges and vision for the future. As such this book is an interesting presentation of *lessons from history* that are invaluable for the development of future strategies of the sector. Kenya being a central country in Eastern Africa has important international visibility, thus findings arising from this book have applicability in many other countries as well. While some of the lessons may be Kenya specific, many are likely to be useful for other developing countries and least developed countries as well.

I highly recommend this book for the sector institutions and development partners. It should be equally beneficial globally for those who seek to glean long-term experiences and other relevant information of water sector development and operations.

Tauno K. Skyttä

Principal Evaluation Officer, The World Bank (rtd)

PREFACE AND ACKNOWLEDGEMENTS

Why water services

Indeed, there has been a bias to piped water supply where the source was accessible and therefore water was taken closer to the people who were near the sources, whereas those several kilometres away from the source were neglected probably due to cost implications. Being agriculture fed economy, presence or absence of water dictates the prosperity of the whole nation, there is an ultimate need to bridge the supply to the areas with scarcity for any meaningful development to be achieved in the Kenya.

Writing about water stemmed from deeply rooted enthusiasm and excitement to demystify the obscurity of water supply in Kenya. Every new finding brought about satisfaction and the desire to go on. However, with time, the information became too much and this came with the need to create an order and build more understanding. The passion became more intense and research assistants were put in and more data was gathered and analysed bringing in more insights as well as complexities, gaps and structural challenges. At this point it became inevitable to turn the events that made Kenya water development into a book.

In seven chapters, this book makes a critical look at the one century of development of water sector from the inception of first water supply in Kenya until the year 2005. Significant issues such as infrastructure, institutional development, water conflict, water policy and legislation and sustainability are discussed and elaborated. The chapters include the introduction, administration and management of water supplies, development and management, drivers of water supply and the futures of water supply.

Why Kenya

The history of Kenya as a nation, when compared to the international timelines, is such young that before 1895, the present Kenya was vast land of boundless and

sedentary pastoral and semi agricultural economies. According to the Water Poverty Index, Kenya ranks among the thirty countries with highest water poverty level at 47.3, in the world, this makes water invaluable in Kenya. Inopportunately, the quality of Kenya's water resources faces serious threats from pollution, siltation, reclamation, pesticides, weed attack, and human population activities. Water is life, it is said, there is nowhere it is aptly demonstrated than in Kenya where the population has concentrated in areas with water sources, while in vast semi-arid areas, the population is very sparse and has most often been neglected.

Distinctively, the political and administrative portfolio for water and sanitation development has constantly changed over the years owing to relative significance the various political regimes attached to water and sanitation. The politics of the day determines the amount and nature of supply. Notwithstanding, the growth in population and urbanisation, need for proper sanitation, socio-economic development, changing management practices and globalisation have been influential in the water development trend.

In a unique set of circumstances, Kenya has had water supply from water condensing plant, rain water harvesting, wells, boreholes, pans and dams, springs, streams and rivers and piped supply. By the year 2005, apart from water condensing plant, all these remained the sources of water supply in Kenya as was in 1900s. The conveyance methods include furrows, water carriers, pumping system and kiosk system. Paradoxically, while water development followed the path of settlement, settlement too followed the path of water development as more townships sprung along the railway and water supply points.

The debate about economic good and social good about water is a critical one in understanding the water sector development. The irony of the poor paying more for water than the rich is as glaring as the empty taps that are billed and the huge amount of unaccounted for water. This book explores the complex water tariff system, the origin, progression, policy and success. Interestingly people outside the urban setup hardly pays for water and obtain water from the natural sources. This timeline details where Kenya water sector is, how it got there, predicts for how long it will be there and why.

Along the years, as the author observes, the water sector has circumvented the solution of water supply as formation of water companies to manage the water assets. The recommendation for increased private water participation is but a reflection of the past whereby ideas are re-digested. Muthaiga Water Company was in operation by 1923 and its major aim was to supply water for the residents of the Muthaiga and upper Nairobi Township estates. The water companies in the reforms agenda serve a specific geographic area.

Change of technology, there appears to be a cyclic use of technology over the years; this is demonstrated by use of reverting to technologies that were in use in between 1900s along 1920. The aspect of rain water harvesting as a main water supply was by 2005 recommended as the major way to solve the endemic water problems

A major drawback in development of Kenya water sector, the history demonstrates is the time span between the realisation of the problem through an enquiry and the implementation. In some instances, decisions and recommendations have taken thirty years to implement. The review of Water Act 372 which was recommended in 1972 and implementation in 2002 is an example. This time lapse has resulted into wastage of resources when redoing the studies to establish similar initial findings which are still applicable

In the efforts to find the most sufficient, capable and dependable water undertaker, water supply docket including assets changed ownership through different departments in the process dubbed hand-over. The Railways under the Public Works Department was the first and handed over to the municipalities, the municipalities that found it difficult to manage water supplies handed over to Water Development Department in the then Ministry of Agriculture and later on Ministry of Water Development. The municipalities and the ministry were unable to effectively handle water and water companies took over the management on behalf.

The author regrets that in spite of the inherent water resource limitations and the high degree of dependence of its economy and social wellbeing on water, Kenya has not adequately invested in infrastructures such as dams, pans, boreholes, pipelines and rainwater harvesting for many years. The weaknesses in the current institutional framework include poor organisational structures, lack of autonomy, and unclear definition of roles and responsibilities. There has been poor coordination between sector institutions leading to wastage of resources and duplication of efforts, lack of adequate skills to manage and operate water supplies.

By the year 2005, the situation of water and sanitation services in Kenya was far from satisfactory. Service coverage and service level was inadequate both in urban and rural areas. Performance of existing water supply systems was poor. However, as a major effort, the water sector reform process started to reorganise the sector in order to achieve the development targets.

Why of my interest

The growth of Kenya water sector has been phenomenal in the last one century. It is an evolution from the earliest water supply in Nairobi sourced from a small concrete dam within the Chiromo Estate and piped by gravitation towards the railway land in 1899 to over 1500 water supply systems managed by various agencies

by the year 2005. Most of the water in the start of the century was owned by the Uganda Railways for the purposes of its workers and for the locomotives. This is a transition from 'people going for water' to 'water going to the people'. The history of water supply in Kenya shows that for the last 100 years since the first water supply in Nairobi, institutional arrangements are still the core operational problem in the provision of water services due to centralized and bureaucratic practices.

The actual construction of the railway started in Mombasa in 1896 to reach Nairobi in 1899 and later to Port Victoria, present day Kisumu City, in 1901. The first piped water supplies were developed and managed by the Railway to serve towns such as Mombasa, Nairobi, Naivasha, Nakuru, Kisumu, Eldoret and Kitale. The government of East African Protectorate occupied the northern frontier district in 1908. In these areas, methods most reliable in 1900 such excavating river beds after heavy rains, collection from various surface rivers, springs and sparsely distributed water holes are still the most applicable and most commonly used to date. The unique water supply scenario is appreciable through four distinctive chronological categories: pre-colonial (1895-1920), Colony and Protectorate (1920-1963), Independence (1963-1980) and Post-Independence (1980-2000) each category with unique challenges, priorities and response and policies.

The pre-colonial period highlights the period before a single piped water supply in Kenya, the development of railways, emergence of townships, development of water supplies and efforts to develop the first water law. The Colony and Protectorate period is marked by development of the first water law, handing over of water ownership to more competent institutions, expansion of water supplies to other sprouting townships, and development of rural water supplies. The independence and post-independence period marked a major shift in development of water supplies; bilateral assistance came in during this period, fully fledged ministry of water was created, a new water law and national water policy were established, and a comparative approach along the international standards was adopted.

The process

This handbook has gone through various stages, from the appreciation of the idea that water development study is a crucial part of our existence to the actual production of the book. An extensive research was carried out to establish the timeline and more so to patch out the gaping holes in this historical review. Public as well as private sources were consulted in provision of data. Such institutions as the Kenya National Archives, Kenya Railways Library, Ministry of Water Development library, Rhodes House in Oxford UK-the colonial archives materials and British Institute in Eastern Africa library. The data collected was used to develop a database of water

supply. A systematic and painstaking process analysed data and developed a timeline, then identified gaps and filled them up through a repeat process. During the analysis, data was classified and interpreted to build up relationships of events and issues that took place between 1895 and 2005.

As the work on this study progressed, the author undertook conscious efforts to disseminate discuss and share new and critical patterns, insights and critiques about the subject. Dissemination was achieved through presentation papers in international conferences, local and regional workshops and publications in peer refereed journals. More dissemination was done through chapters in scholarly books.

Limitation

Looking back at the magnitude of physical secondary material collected through bulks of colonial files copies, cutting and the tiring physical process, every researcher will acknowledge the limitations encountered. Retrieval of archival materials based on the complex filing and retrieval systems coupled with dust from the old non used files called for physical strength and care, delay in retrieval of the requested documents, and illegibility of the old documents were the major setbacks. Worth of note is the immense financial obligations that this study demanded to fulfil individual interests to write this book.

Special thanks

Given the technical and complex nature of this study, a multidimensional approach was necessary. To this end, contributions and insights from scholars in social economics and engineering were sought. I was honoured with immense contributions from Brian Shikholi, Isaiah Omosa, Moses Mwangi, Tauno K Skyttä and Petri Juuti. I wish to acknowledge special contributions from Allan G Muruga, the core research assistant from the start to the publishing of this book and Prof Tapio SW Katko from University of Tampere Finland, for well-informed insights, criticism and comparative guidelines on the theme. I wish to acknowledge the immense support from the Academy of Finland (no. 288153) in ensuring the success of the entire manuscript.

ACRONYMS AND ABBREVIATIONS

AC	Asbestos Cement
ACA	Athi Catchment Area
ADC	Assistant District Commissioner or African District Council
AID	American International Development
ALDEV	African Land Development Board
ASAL	Arid and Semi-Arid Land
BEAP	British East Africa Protectorate
CDA	Coast Development Authority
CDAs	Community Development Assistants
CIDA	Canadian International Development Agency
CMS	Church Missionary Society
CO	Colonial Office
CWB	Central Water Board
CWPs	Communal water points
DACs	District Agricultural Water Committees
DARA	Development and Reconstruction Authority
DC	District Commissioner
DCU	Dam Construction Unit
DDA	Demand-driven Approach
DDC	District Development Committee
DHO	District Health Officer
DI	Ductile Iron
DWD	Director of Water Development
DPW	Director of Public Works
EARC	East African Railways Corporation
ENNCA	Ewaso Ng'iro North Catchment Area
EPZ	Export Processing Zone
FINNIDA	Finnish International Development Agency
CWSMP	Community Water Supply Management Program
GI	Galvanised Iron
GoK	Government of Kenya
GRSSA	Garissa

GTZ	Germany Agency for Technical Corporation
GWP	Global Water Partnership
HB	Hydraulic Branch
IBEAC	Imperial British East Africa Company
ITCZ	Inter Tropical Convergence Zone
IBRD	International Bank for Reconstruction and Development
IWRM	Integrated Water Resources Management
JICA	Japan International Corporation Agency
KEFINCO	Kenya Finland Company
FWWSP	Kenya-Finland Western Water Supply Program
KNA	Kenya National Archives
KUESP	Kibera Urban Water Environment and Sanitation
KWASP	Kwale Water and Sanitation Project
LGLA	Local Government Loans Authority
LVNCA	Lake Victoria North Catchment area
LVSCA	Lake Victoria South Catchment Area
MoA	Ministry of Agriculture
MoLG	Ministry of Local Government
MLRR&WD	Ministry of Land Reclamation, Regional and Water Development
MENR	Ministry of Environment and Natural Resources
MUWSP	Minor Urban Water Supply Programme
MoNR	Ministry of Natural Resources
MoW	Ministry of Works
NMGS	Nairobi Metropolitan Growth Strategy
NEAP	National Environment Action Plan
NFD	Northern Frontier District
NWCPC	National Water Conservation and Pipeline Corporation
NWMP	National Water Master Plan
O&M	Operation and Maintenance
PD _o A	Provincial Director of Agriculture
PAWCs	Provincial Agricultural Water Committees
PWD	Public Works Department
RNAS	RN Aerodrome Services
RDWSSP	Rural Domestic Water Supply and Sanitation Programme
RVCA	Rift Valley Catchment Area
Rs	Rupees
SAPs	Structural Adjustment Programmes
SCSU	Soil and Water Conservation Service Unit

SDA	Supply-driven Approach
SIDA	Swedish International Development Co-operation Agency
SSiPs	Small Scale Independent Providers
TARDA	Tana River Development Authority
TCA	Tana Catchment Area
uPVC	Polyvinyl Chloride
VLOM	Village Level Operation and Maintenance
WSBs	Water Services Boards
WRAP	Water Resource Assessment Project
WASREB	Water Services Regulatory Board
WSUD	Water Sensitive Urban Design
WSD	Water and Sanitation Departments
WHO	World Health Organisation
WRA	Water Resources Authority
WSS	Water Supply and Sanitation
WSRS	Water Sector Reform Secretariat
WUASP	Water Users Support Programme
UDD	Urban Development Department
UNICEF	United Nations Children's Fund
UWASAM	Urban Water and Sanitation Management

DEFINITION OF TERMS

Boma	The residence of government workers, this is where the administrators, medical officers, and other government officials lived. In some cases, it was built within a township.
Debe	an approximately twenty litre container used to fetch, carry or store water
Rupee	Indian currency used as formal currency in Kenya and Uganda in 1905; it was abolished after Kenya became a crown colony in 1920. One rupee was estimated to be equivalent to two Kenya shillings
Baraza	A meeting, usually at local level within a location or sub location for example, chief's baraza
Duka	A building within township where sales and purchases takes place, this includes water kiosks
Kenyan pound	The term was used to refer to an equivalent of 20 Kenya shillings before 1970s
Harambee	A word describing the occasion of pulling together particularly resources and is used commonly to define a meeting to raise funds
Askari	a police or a guard
Native	Locals, indigenous people, Africans in most cases used derogatively to refer to uneducated African

Significant personalities in the history

Williams GB	George Bransby William carried out the first comprehensive water and sanitation study of Nairobi and Kenya in general in 1907.
Lord Delamere	3 rd baron Delamere KCMG born in April 1870, was one of the most influential British Settlers in Kenya

Dr. Sikes	The Director of Public Works Department who commissioned to investigate the water law after the first World War
Dr. Classen	Dr. Classen investigated the water supply system in Garissa and designed a development plan and developed The Classen Report
Dr. Kathnack	A water expert from South Africa invited to carry out water augmentation for Nairobi during the World War II

Units of measures

Gallon	an equivalent of 4.546 litres
Mile	an equivalent of 1.609 kilometres
Foot	an equivalent of 0.304 metres
Cubic foot	an equivalent of 28.31 litres
Inch	an equivalent of 0.24 centimetres
Cusec	a unit of flow equal to one cubic feet per second

Units

Kms	Kilometres
Km ²	Kilometre square
M ³	Cubic metres
Mm ³	Million cubic metres
gpd	Gallons per day
kms	Kilometres
Mgd	Million gallons per day
Gal	Gallon
HP	Horse power
Cu	Cusecs

CHAPTER ONE

1.0 INTRODUCTION

It is important to emphasise the fact that water is a critical resource to all aspects of human development. It is as old as human life itself. Not only is it the basis of human survival, but water has also been a catalyst to major civilisations and to modern industrial development. In Africa, as is the case in other parts of the developing world, water plays an important role in the social and economic activities of the continent. It is used in all facets of society: in domestic sector, agriculture, energy, industry, mining, fisheries, recreation and tourism¹.

Water was also important during the heyday of European explorations of Africa. From the late fifteenth century onwards, explorations into the interior of Africa used water transport extensively. Most explorers followed river courses and that required a fair amount of knowledge about navigation and the nature of water resources. Moreover, in some cases, water bodies formed, in some cases, boundaries of the newly carved out colonial territories in Africa. Rivers and lakes were not only important features for demarcating boundaries; but also used as an important means of transportation in the twentieth century².

Historically, access to natural resources in African societies was secured through complex institutional arrangements based on geographical territories, a social-political age grade system and kinship³. Although the first written water legislation in East Africa Protectorate (Kenya) was put in place in the 1920s it is clear that indigenous

1 Tempelhoff J.W.N (2005). African Water Histories, Vaal Triangle Faculty North-West University Vanderbijlpark, 2005.

2 Tempelhoff J.W.N. (2005). African Water Histories, Vaal Triangle Faculty North-West University Vanderbijlpark, 2005.

3 Jacobs A. H (1963). The Pastoral Maasai of Kenya: A Report of Anthropological Field Research. Department of Anthropology, University of Illinois, Illinois.

cultures erected institutions to control and manage water long before that. It is sufficient to point to the fact that fairly advanced irrigation systems were in use in the Rift Valley at Engaruka in Tanzania, around 1400-1700 AD⁴. The construction and management of these systems could not have been achieved without social organisation and an institutional framework.

Studying the history of traditional water institutions in Kenya is not straightforward as these institutions have generally not been codified and written down. Instead, they are embedded in traditional culture, where they could be said to form a traditional water regime.

Meinzen-Dick and Nkonya identified a number of general features in much of African customary water law. First, water was a resource commonly held by the community and no person could be denied water for 'primary uses' such as domestic water supply. Despite this universal right for domestic water, certain water rights were allocated to groups or individuals for specific uses through a social negotiation process⁵. These features were also central for most customary water institutions in East Africa. Water was treated as a common good, but certain water rights could be acquired. Although water was a common good, this should not be confused with an open-access system⁶. Institutions were put in place to exert control over the resource. The control and rights to water exercised by an individual or a group increase with the group's input of labour or capital into the development of the resource⁷. Often these water rights were not fixed, but negotiable, in order to adapt to changing circumstances. In times of water scarcity, tougher restrictions could be imposed on water uses and earlier rights hence revoked. Such renegotiation of claims and rights under external pressure has been recorded in traditional communities in both Kenya and Tanzania⁸. What sometimes could be perceived as an insecurity of

- 4 Sutton J. E. G (2004). 'Engaruka. The success and abandonment of an integrated irrigation system in an arid part of the Rift Valley c. fifteenth to seventeenth centuries', in M Widgren and J E G Sutton (eds) *Islands of Intensive Agriculture in Eastern Africa, past & present*, James Currey Ltd, Oxford
- 5 Meinzen-Dick R and L Nkonya (2005). 'Understanding legal pluralism in water rights: lessons from Africa and Asia', paper presented at International workshop on 'African Water Laws: Plural Legislative Frameworks for Rural Water Management in Africa', 26-28 January 2005, Johannesburg, South Africa. Internet source checked 2006-11-01 <http://www.nri.org/waterlaw/AWLworkKESop/MEINZEN-DICK-R.pdf>.
- 6 Carlson E (2003). To have and to hold: continuity and change in property rights institutions governing water resources among the Meru of Tanzania and the BaKgatla in Botswana, 1925-2000, Almqvist & Wiksell International, Lund, Sweden.
- 7 Huggins C (2000). Rural Water Tenure in East Africa. A comparative Study of Legal Regimes and Community Responses to Changing Tenure Patterns in Tanzania and Kenya. Final Draft. BASIS CRSP, University of Wisconsin-Madison. Internet source checked 2006-11-01, <http://www.ies.wisc.edu/lrc/live/bashorn0005a.pdf>
- 8 Orindi V and Huggins C (2005). 'The dynamic relationship between property rights, water resource management and poverty in the Lake Victoria Basin', paper presented at International Workshop on 'African Water Laws: Plural Legislative Frameworks for Rural Water Management in Africa', 26-28 January 2005, Johannesburg, South Africa. Internet source checked 2006-11-01 <http://www.acts.or.ke/prog/energy/reports/ORINDI-V.pdf>

tenure in customary water law could instead be seen as a rational response to manage uncertainty in the physical environment⁹

Much of the customary water institutions in East Africa have been dismantled through the superimposition of statutory law and through major changes in governance system and social structure. Despite this, customary water institutions have partly persisted, and have been important in some rural communities. This has created a situation where several water regimes co-exist and overlap. In addition, water tenure in East Africa is intertwined with land tenure, where also several legal regimes including customary and statutory co-exist¹⁰. In Uganda for instance, the issue of land tenure has proven particularly complex¹¹.

During the early colonial period there were doubts whether the present East African protectorate offered the commercial opportunities that Britain had found in other parts of its empire and so as far as colonial office was concerned, the maintenance of law and order was far more important than economic development or social engineering. The colonial office (CO) was the most important department of state as far as the framing and implementation of policy for Britain's African colonies such as the East African Protectorate was concerned. In theory, the other most important groups external to the CO were parliament and the cabinet. The secretary of state was responsible for the actions of the CO as regards any colonial dependency, in fact, neither parliament nor the cabinet exerted continuous or direct influence on policy for Kenya¹². At the turn of the century, the commercial potential of Kenya's highland became more apparent to British government officials.

The existence of man has been over millions of years dictated by among other factors the availability, quality, distribution and amount of water. As the world grapples with the shortage of water, the Kenyan situation has been over the years getting worse as water sources continue to diminish. This has motivated politicians as well as policymakers to focus keenly on water development strategies.

The book of history of water supply and governance in Kenya captures concerns about scarcity of water resources, its potential impact on the society, and search for an appropriate way to respond to the looming disaster. Water history is situated

9 Ostrom (1990) have stated that sustainable institutions for common pool resources need to be flexible. North (2005) maintains that institutions in essence are created in order to deal with the uncertainties that societies are exposed to.

10 Meinzen-Dick R and Nkonya L (2005). 'Understanding Legal Pluralism in Water Rights: Lessons from Africa and Asia', Paper Presented at International Workshop on 'African Water Laws: Plural Legislative Frameworks for Rural Water Management in Africa', 26-28 January 2005, Johannesburg, South Africa. Internet, <http://www.nri.org/waterlaw/AWLworKESop/MEINZEN-DICK-R.pdf>. 2006-11-01

11 Nawangwe B. and Nuwagaba A. (2002). Land Tenure and Administrative Issues in Kampala City and their Effects on Urban Development. Research Report, Makerere University, Kampala.

12 Brett E. A (1973). Colonialism and Underdevelopment in East Africa (London: Heinemann, 1973). 58-59.

within the political, ideological, aesthetic and economic fields of social history and eco-history as well as history of science. It delves into how water has been managed on community level, as well as national, international and global scales. Within this book is the recognition of the existing water management policies, practices and outlooks emanating from deep seated ideas, beliefs and values as well as political inequalities, and technological disparities.

This book elucidates the various innovations and how they were accepted within a community and eventually by the society. In this respect, the role of prominent and ordinary individuals in initiating and propagating ideas and practices through human encounters and communication devices is acknowledged. In this historical quest, how ideas and practices emerging in everyday circumstances are transformed into modalities and eventually norms, sacred believes, cognitive structures schemata and paradigms are recognized as important tools in bringing man closer to his history. The author intends to create a close relationship between an ordinary man deeds and the eventual greatest innovation.

1.1 Physical Conditions

Kenya is located on the East Coast of Africa, with the equator running almost straight through the middle of the country. Kenya borders with Somalia, Ethiopia, and South Sudan in the north, Uganda in the west, Tanzania in the south and the Indian Ocean in the east. Territorial area is 582,646 km² and it is divided into water area of 11,230 km² and land area of 571,416 km². The major part of the inland water surface area is covered by a portion of Lake Victoria and Lake Turkana. Of the land area, approximately 490,000km² (close to 86 percent of the land area) is classified as arid and semi-arid land (ASAL). The remaining area of about 81,000 km² is classified as non-arid and profitably usable lands, sustaining a substantial portion of Kenyan economy and human population.

Kenya is characterised by a tremendous topographical diversity, ranging from glaciated mountains to a true desert landscape. The elevation varies greatly from sea level at the Indian Ocean to 5199m at the Batian Peak of Mount Kenya.

The climate in Kenya is primarily influenced by the movement of the Inter Tropical Convergence Zone (ITCZ) and by topographic relief, especially elevation. The rainfall in Kenya is affected by large water bodies like Lake Victoria, complex topography with the Great Rift Valley and high mountains like Mt. Kenya and Mt. Elgon. A relatively wet and narrow tropical belt lies along the Indian Ocean coast. Behind the coastline there is a stretch of large areas of semi-arid and arid lands.

Kenya generally experiences two seasonal rainfall peaks (long rain and short rain) in most places. Mean annual rainfall over the country is 680 mm. It varies from about 200mm in the ASAL zone to about 1,800mm in the humid zone. Figure 1.1 illustrates the average annual rainfall in various climatic regions in Kenya¹³.

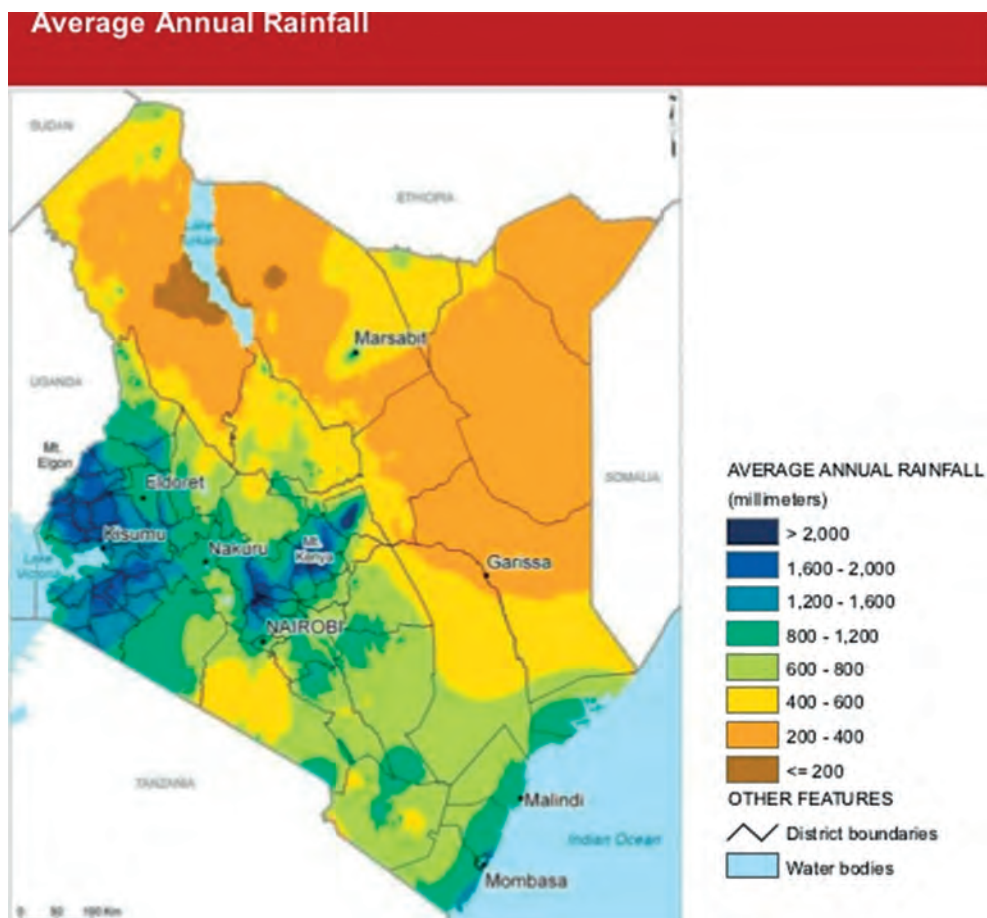

Figure 1.1: The average annual rainfall

The history of Kenya can be distinctively separated into three periods, pre-colonial period (before 1920), colonial period (1920-1963) and post-colonial period (from 1963 to date). Kenya was established as a British protectorate (1895) and a crown colony (1920). The Mau Mau rebellion of the 1950s was directed against European

¹³ Ministry of Environment and Central Bureau of Statistics, Kenya (2008). Nature's best in Kenya: An Atlas of Ecosystems and Human Wellbeing-Chapter 3 Water. World Resource Institute

colonialism. In 1963 the country became fully independent, and a year later a republican government was elected.

Cushitic-speaking people from northern Africa moved into the area that is now Kenya beginning around 2000 BC. Arab traders began frequenting the Kenya coast around the first century AD. Kenya's proximity to the Arabian Peninsula invited colonisation, and Arab and Persian settlements sprouted along the coast by the eighth century. During the first millennium AD, Nilotic and Bantu peoples moved into the region, and the latter now comprises three-quarters of Kenya's population.

The colonial history of Kenya dates back from the establishment of Imperial Germany's protectorate over the Sultan of Zanzibar's coastal possessions in 1885. This was followed by the arrival of Sir William Mackinnon's British East Africa Company (BEAC) in 1888, after the company had received a royal charter and concessionary rights to the Kenya coast from the Sultan of Zanzibar for a 50-year period. Germany handed its coastal properties to the British Empire in 1890, in exchange for German control over the coast of Tanganyika.

As recent as 1885, the entity Kenya did not exist. The area which the nation Kenya occupies was a conglomeration of various communities without political boundaries or administration. For centuries the land had been occupied by a myriad of different people. The inhabitants settled near water sources and forests from where farming, hunting and gathering were the main source of sustenance. The colonial history of Kenya dates from the Berlin Conference of 1885, when the European powers first partitioned East Africa into spheres of influence. In 1895, the U.K. Government established the East African Protectorate.

After the Berlin treaty in 1885, the British East Africa Association was founded by William Mackinnon with encouragement from the British government. This led to the creation of the Imperial British East Africa Company, chartered in 1888, and given the original grant to administer the dependency. At the same time, the European missionaries and settlers gradually penetrated the interior. The administration was transferred to the Foreign Office in 1895, and to the Colonial Office in 1905. Nairobi was the administrative headquarters.

The Uganda Railways

However, it was the construction of the railway line from Mombasa to Kisumu, and then to Uganda that not only opened but created a country. Construction of the line started at the port city of Mombasa in 1896 and reached Kisumu, on the eastern shore of Lake Victoria, in 1901 (figure 1.2). Although almost all of the rail line was actually in the colony that would come to be known as Kenya, the original

purpose of the project was to provide a modern transportation link to carry raw materials out of the Uganda colony and to carry manufactured British goods back in.

The construction of the Kenya Uganda Railway was a turning point in creation of the nation Kenya and development of townships. In fact, all major towns in Kenya have origin from rail stations. Mombasa was the capital city of Kenya until 1906 when the status was transferred to a more central Nairobi.



Figure 1.2: Uganda railway near Mombasa, about 1899AD¹⁴

The year 1908 and a few years after saw, probably, the peak of the settlement wave. In one week in July a shipload of 280 Dutchmen arrived from South Africa (from the Ermelo and Carolina districts of the Transvaal) with complete houses and wagons and ploughs. They trekked up to the Usain Gishu plateau with the intention of growing large acreages of wheat. Here they founded, with Boers who had preceded them, a “Dutch pocket in that part of the highlands most resembling the South African high veld”¹⁵. They started their own little township and called it Eldoret. The governor during this period was Sir Percy Girouard who was French Canadian, born in Montreal. He had succeeded Sir Hayes Sadler. Prior to Sir Percy appointment to East Africa he was the Governor of Nigeria after Fredrick Lugard. Once in East Africa he improved the relationship between governor and the governed and this saw another influx of settlers. He is the one who put up the railway line to Thika passing through coffee and sisal areas. During Sir Percy Girouard regime the protectorate made the biggest economic advance it had yet achieved. Revenue was made to meet expenditure, and the grant-in-aid was abandoned¹⁶.

14 Kenyanchui S. S. S (1992). European settler agriculture, an economic history of Kenya, edited by Ochieng W. R and Maxon R. M East African Educational Publishers Ltd, Nairobi, Kenya.

15 Kenyanchui S. S. S (1992) European settler agriculture, an economic history of Kenya, edited by W. R Ochieng and R M Maxon East African Educational Publishers Ltd, Nairobi, Kenya.

16 Kenyanchui S. S. S (1992) European settler agriculture, an economic history of Kenya, edited by W. R Ochieng and R M Maxon East African Educational Publishers Ltd, Nairobi, Kenya.

In many places where rainfall was not adequate, the settlers had to find their own means of water supply. For example, Lord Delamere, one of the first and most influential British settlers in Kenya, in 1914 planned a water supply from the Rongai River to his Soysambu farm. Water was piped for 26 kilometres and thirty-nine tanks were built at regular intervals so that homesteads could be dotted along it. The cost was considerable, about £12,000.

As the towns rapidly grew, population increased and the British administration gained more control over the inhabitants. The political administration was fast shifting from the decentralized tribal administration into centralized administration under the British rule. The following years saw the beginning of the process of subjugating the local indigenous peoples to colonial rule and administration. The process of land acquisition gained momentum with the construction of the railway from Lake Victoria to the coast in 1904 opening up the highlands to farming, and leading to the establishment of Native Reservations to house the local peoples. Considerable number of Indian labourers was imported into the area to assist in the railway construction adding to economic, social and political tensions and demands.

World War 1 saw conflict in the region between the British and German colonial powers with severe damage to the agricultural base of the economy. However, after the war, the economy began to revive and stabilise, the desire to entrench political domination grew and resulted in the declaration of the Kenya Colony in 1920. The local Legislative Council was the scene of competing demands for power between the European and Indian settlers, whilst the African population became the subjects of Trusteeship. By 1920, Kenya became a crown colony. The social economic and political (including water supply, sanitation and pollution control) development of Kenya closely followed its colonisation pattern. After independence in 1963, Kenya inherited, maintained and worked on improving them. However, there was a slight change on prioritisation.

1.2 Population

Estimates of the population of Kenya have been made since the end of the nineteenth century. Many of the early travellers hazarded guesses as to the numbers of people living in the countries (East African) through which they passed¹⁷

The first official estimates were those made by Sir Arthur Hardinge (First Commissioner and Consul General) for Kenya. He placed the population at 2.5

¹⁷ Blacker J. G. C (1969). *East Africa: Its peoples and resources*. Oxford University Press, London.

million. Between the wars (World War I and II), the population figures continued to be based principally on the number of taxpayers¹⁸.

The first census of the non-African population was held in 1921¹⁹. In 1948, the East African Statistical Department was created as one of the services of the East Africa High Commission and a full census of the population for Kenya, Uganda and Tanganyika including Zanzibar islands was conducted. Kenya's population was found to stand at 5.4 million of whom 154,846 were non-Africans²⁰.

Between 1948 and 1962 the country's population growth was estimated to be between 2.5 and 3 per cent. The total population by the 1962 census was 8,636,263 of whom 8,365,942 were Africans and 270,321 were non-Africans. According to this census, the population density was calculated at 16 people per square kilometre, while the number of urban centres (towns) was found to be 34 and their aggregate population was found to constitute 7.8 per cent. Of the urban population, the non-African stood at 84.8 per cent while the African at 15.1 percent²¹.

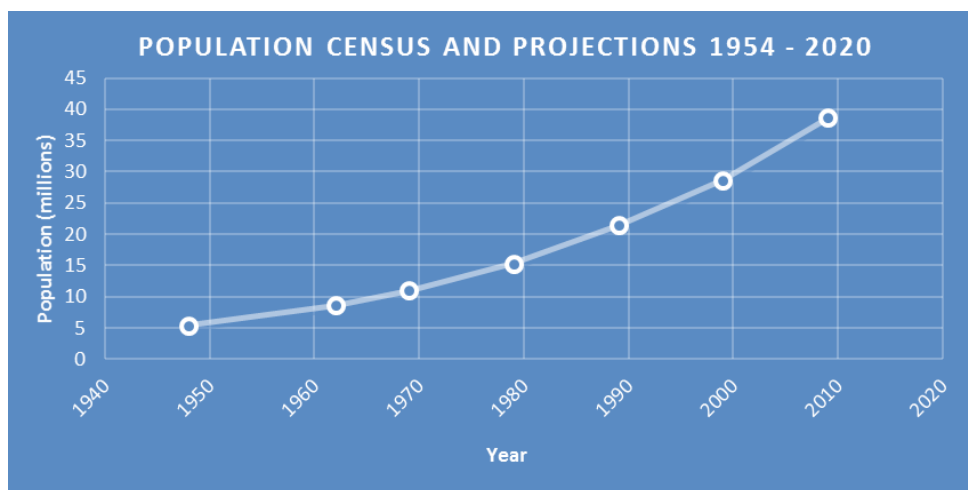

Figure1.3: Population census 1948-2010²²

The 2002-2008 National Development plan²³ and the key demographic variables indicate that the quality of life of the population has been on the decline despite

18 Kenya National Archives (1995). A guide to the contents of the Kenya National Archives and Documentation Service, Kenya National Archives, Nairobi, Kenya.

19 Blacker J. G. C (1969). East Africa: Its peoples and resources. Oxford University Press, London.

20 Blacker J. G. C (1969). East Africa: Its peoples and resources. Oxford University Press, London.

21 Blacker J. G. C (1969). East Africa: Its peoples and resources. Oxford University Press, London.

22 Blacker J. G. C (1969). East Africa: Its peoples and resources. Oxford University Press, London.

23 Republic of Kenya (2002a). National Development plan 2002-2008. Effective Management for Sustainable Economic Growth and Poverty Reduction. Government Printers, Nairobi, Kenya.

the gains made in the demographic transition. The demographic gains made in the 1970s and 1980s were not sustained in the 1990s. The life expectancy has declined substantially while both infant and mortality rates are on the increase.

CHAPTER TWO

2.0 ADMINISTRATION AND MANAGEMENT OF WATER SERVICES

2.1 General Overview

This chapter examines the water administration and management through assessing who got what water, when and how and scrutiny of who had the right to water and related services. The analyses include a review of the processes of interaction based on accommodation rather than domination. The chapter covers a range of issues intimately connected to water from health to security, economic development, land use and the preservation of the natural ecosystems on which water resources depended. The different timeline administrative regimes and management in Kenya in the period between 1895 and 2003 are illustrated in the various sections.

2.2 Imperial British East Africa Company (1888–1895)

Table 2.1 shows key water supply events preceding the first major piped water supply in Kenya in 1905.

Table 2.1: Key water supply events before 1905

Period	Key water supply events
Before 1905	No legislation on water resource use. Very few water supply schemes (almost none), primitive water collection methods were predominant.
	Water was a resource commonly held by the community and no person was denied water for primary uses. Certain water rights were allocated to groups or individuals for specific uses through a social negotiation process.

By 1880s, the inland areas of the present Kenya comprised a web of domestic economies of complementary nomadic and sedentary pastoral forms of production. Access to natural resources was secured through complex institutional arrangements based on geographical territories, a socio-political age grade system and kinship¹. Although the first written water legislation in Kenya was put in place in the 1929, it is clear that indigenous cultures erected institutions to control and manage water long before that². Construction and management of these systems could not have been achieved without social organization and an informal institutional framework³.

It's through flexible water rights, that the society was able to sustain and ensure effective and efficient water use. No cases of offenders or thereof punishment have been recorded, therefore it is assumed that enforcement of law and order was effective whether through kinship, socio-political age grade system or geographical territories.

2.3 British East Africa Protectorate (1895–1920)

Table 2.2 shows key water supply events during the period 1905 to 1920 when Kenya was referred to as British east Africa Protectorate.

- 1 Jacobs A. H (1963). *The Pastoral Maasai of Kenya: A Report of Anthropological Field Research*. Department of Anthropology, University of Illinois, Illinois.
- 2 Sutton J. E G (2004). 'Engaruka. The Success and Abandonment of an Integrated Irrigation System in an Arid Part of the Rift Valley. Fifteenth to Seventeenth Centuries', in M Widgren and J E G Sutton (eds) *Islands of Intensive Agriculture in Eastern Africa, Past & Present*, James Currey Ltd, Oxford.
- 3 Huggins C (2000), *Rural Water Tenure in East Africa. A comparative Study of Legal Regimes and Community Responses to Changing Tenure Patterns in Tanzania and Kenya*. Final Draft. BASIS CRSP, University of Wisconsin-Madison. Internet source checked 2006-11-01, <http://www.ies.wisc.edu/lrc/live/bashorn0005a.pdf>.

Table 2.2: Key water supply events between 1905 and 1920

Period	Key Water Supply Events
1905	Uganda Railways as the main water asset developer but leasing to other service providers. The Uganda Railways established the first water supply schemes along the railway line stations to serve the steam engines and railway employees. These water supplies became a significant stimulant for water development.
1906	The first major water supply system for Nairobi from Kikuyu springs.
1916	Marere springs pipeline for Mombasa water supply commissioned.
	Sir McGregor Ross, Director of Public Works started writing the water ordinance.

Kenya was declared the British East Africa Protectorate (BEAP) in 1895, after the British Government bought out the Imperial British East Africa Company for £250,000- although it had cost the Company nearly twice as much to keep their assets intact. Britain established a protectorate over the whole expansive land from Mombasa to the Uganda border, which then ran through Eldama Ravine to Naivasha and the Rift Valley. The protectorate was put under the Foreign Office. After this, the construction of the Uganda Railway began in Mombasa in 1896 and reached Nairobi in 1899 and later Port Victoria present day Kisumu City, in 1901⁴. The Uganda Railways became the pioneer for the development of water supplies in Kenya. The first piped water supplies were developed and managed by the Uganda Railways to serve major towns⁵.

From the beginning, the general water supply administration was undertaken by the Hydraulic Branch (HB), of the Public Works Department (PWD) under the Director of Public Works (DPW) and was headed by the hydraulics engineer. The general responsibility of the DPW, with regard to water, was the administration of the Water Law in the Colony and undertaking hydro-graphic survey. In 1902 and 1903, HB opened offices in the colonial capital, Nairobi and Kisumu on Lake Victoria respectively. By 1910, HB had offices in the Rift Valley towns of Naivasha and Eldoret and in the Mount Kenya region in Nyeri⁶.

4 Marsh Z.A. and Kingsnorth G.W (1965). *An Introduction to the History of East Africa*. Cambridge University Press, 3rd Edition. British Institutes of History and Archaeology in East Africa.

5 Colony and Protectorate of Kenya (1913-1923). *Muthaiga Water Supply*. Kenya National Archives, Ref: AG/43/103, Nairobi, Kenya.

6 Nyanchaga E.N & Ombongi K.S (2007). *History of Water Supply and Sanitation in Kenya, 1895-2002*. Environmental History of Water, Chapter 21. IWA Publishing, Alliance House, 12 Caxton Street, London UK.2007.

In 1926 the Executive Engineer's offices at Naivasha were transferred to Nakuru and in 1931 the Nakuru division was absorbed in the division of the Executive Engineer, Nairobi⁷.

The first director of Public Works Department, Mr. R. M. Batey was appointed in 1903 and at this time he was assisted by three officials with the titles of superintendents of public works. On the 6th April 1905, Mr Batey was replaced by Mr. McGregor Ross as director of PWD and by this time the staff consisted of 13 European and non-European officers⁸.

When the Uganda Railway reached Nairobi, the population of the European increased drastically from 559 to 10,400, with limited water supply sewerage disposal problems started⁹. Disease epidemics, such as 1902 and 1907 plague in Nairobi played a major role in accelerating the need for and consequent response to improve sanitation¹⁰. In an attempt to curb the spread of diseases, propaganda/campaigns and sometimes coercion were used to ensure natives built and used latrines¹¹.

By 1907, water supply was under the management of the railway authorities, who put in place piped system, complete with pumps, tanks and distribution networks. Most systems were quite simple and were supplemented with wells and with rainwater, stored in tanks by each household¹². For the Nairobi supply, the railway authorities developed the Kikuyu springs as the primary source in 1906, which is still in use today¹³.

Gradually, motives for an enlarged role of the state in relation to water began to surface in the first two decades of the 1900s. Williams (1907)¹⁴ noted that the public objectives of urban development and health were not always congruent with those of the railway. The water supplies in these small budding towns were primarily to provide water for the needs of the railway and the Europeans, "The argument was used to mean that it was not worthwhile expending any huge sum of money

7 Kenya National Archives (1995) A guide to the contents of the Kenya National Archives and Documentation Service, Nairobi, Kenya.

8 Kenya National Archives (1995) A guide to the contents of the Kenya National Archives and Documentation Service, Nairobi, Kenya.

9 Thornton, Silberman L and Anderson, P (1948). Nairobi Master Plan for a Colonial Capital. Municipal Council of Nairobi. London His Majesty's stationery office 1948. Kenya National Archives, Ref: 711.4WHI.

10 Williams G.B (1907). Report on the Sanitation of Nairobi and Report on the Townships of Naivasha, Nakuru, and Kisumu. Kenya National Archives, GP, 363.7.BRI. 1907.

11 Thomson C.B (1917). Reference no 11/120 of 4/5/17. Kenya National Archives, PC/Coast/1/15/71, Ref: 143/39/17. 12th May 1917.

12 Williams G. B (1907). Report on the Sanitation of Nairobi and Report on the Townships of Naivasha, Nakuru, and Kisumu. Kenya National Archives, GP, 363.7.BRI. 1907.

13 Colony and Protectorate of Kenya (1913-1923). Muthaiga Water Supply. Kenya National Archives, Ref: AG/43/103, Nairobi, Kenya.

14 Williams G. B (1907). Report on the Sanitation of Nairobi and Report on the Townships of Naivasha, Nakuru, and Kisumu. Kenya National Archives, GP, 363.7.BRI. 1907.

on supplying Kisumu with good water because the number of Europeans there was so small¹⁵”.

During this period, the African institutions were systematically eroded and the customary role they played was heavily circumscribed by its integration into the market economy. The controls of natural resources by customary authority, for example in the Maasai community, were weakened under colonial administration by land expropriation for the settler economy. In 1904-05, the British forcibly moved certain sections of the Maasai out of their grazing grounds to areas without water. The Maasai chiefs were against the move as they argued that the proposed territory was not large enough and with limited water resources that sprang from European allocated areas¹⁶.

2.4 Kenya as Protectorate and Colony (1920-1963)

Table 2.3 illustrates key water supply events in Kenya as a protectorate and colony.

Table 2.3: Key water supply events between 1920 and 1963

Period	Key Water Supply Events
1921	World economic depression followed soon after the change of currency from rupee to shilling. The staff of public works were reduced by half and water development declined.
1926	Underground water exploitation was recommended in lieu of economic situation after the conference on water legislation held the same year.
1928	Establishment of a committee to discuss water legislation of 1916, 1921 and the version of 1922.
1929	First water legislation enacted and operationalized. Overall ownership vested in the government.
1939-1945	Population boom in Nairobi due to influx of soldiers which put pressure on water resources. Second major water supply development for Nairobi in 1945 from Ruiru.
1946	African land development (ALDEV) formed in the MoA to develop water resources for agriculture especially in the rural area and continued its work up to 1964 when it merged with HB.
1949-1953	Period of considerable dam construction by ALDEV under the ministry of agriculture to enhance agriculture.
1951	Water Resources Authority (WRA) was established.
1952	Water Act (Cap 372)

15 Williams G. B (1907). Report on the Sanitation of Nairobi and Report on the Townships of Naivasha, Nakuru, and Kisumu. Kenya National Archives, GP, 363.7.BRI. 1907.

16 Lotte H (2006). Moving the Maasai, A Colonial Misadventure. Palgrave Macmillan, in Association with St Anthony’s College, Oxford.

1954	The Swynnerton Plan for agricultural development. A significant amount of water development activities was in-built. A considerable number of water schemes were developed especially in Nandi.
1957	Commission of Sir Hebert Manzoni (recommended the transfer of Hydraulic Branch from the Ministry of Public Works to Ministry of Agriculture.
1957	Mombasa pipeline Board was established, ordinance No. 15 of the laws of Kenya.
1959-1960	Need to enhance agriculture. Several major rural water pipelines established namely: Rongai, Westacre, Kibichori, Visoi, Olobanaita, Enarosura, Kinangop Elburgon, and Kinja).
1960	WHO/UNICEF through the Ministry of Health started to fund development of rural water supply after recognizing the health problems created by poor quality water.
1962	Revision of the Water Act (Cap 372). Overall ownership of water resources is vested in the government.

Towards the end of 1920s, the state had taken over from the Uganda Railways as the main service provider of water in urban areas¹⁷. As the Public Works Department developed new township water supplies, some railway water supplies were abandoned and the Railways connected to the new supplies¹⁸.

Dixey scheme was put forward in 1943 and covered the water scarce areas of the Northern Frontier Districts¹⁹. After a pilot project, the Water Resources Authority recommended that water development in the Northern Province should be restricted to the exploitation of surface catchments and construction of pans, dams and tanks²⁰.

After the Second World War, the British government, under the Colonial Development and Welfare Act, invested in the British colonies to boost economic and social development²¹. Consequently, the colonial government (Figure 2.1), in 1946, launched an ambitious investment programme under the Development and Reconstruction Authority (DARA), which sparked off a rapid development of urban water supplies²² and African Land Development Board (ALDEV). It emerged with policies specifically aimed at intensifying arid and semi-arid lands (ASAL) production²³.

17 Colony and Protectorate of Kenya (1930). Report for 1929 His Majesty's Stationery Office, London Ref: AG/43/79, Nairobi, Kenya.

18 Nyanchaga E.N & Ombongi K.S. (2007). History of Water Supply and Sanitation in Kenya, 1895-2002. Environmental History of Water, Chapter 21. IWA Publishing, Alliance House, 12 Caxton Street, London UK.2007.

19 Dixey F (1950) Hydrological report on the Northern Frontier District, Samburu and Turkana and Report on the Hydrology of the Uaso.

20 Provincial Commissioner (1951). Northern Frontier Province, Annual Report of 1951. Kenya National Archives. PC/NFD/1/1/10, 1951.

21 Fielhouse D. K (1999). The West and the Third World: Trade, Colonialism, Dependence, and Development, Blackwell Publishers, Oxford 1999.

22 Colonial Office (1950). Annual Report on the Colony and Protectorate of Kenya for the year 1948. His Majesty's Stationery Office, London.

23 Provincial Commissioner (1946). Annual Report Northern Frontier District, 1946. Kenya National Archives. PC/NFD/1/1/8, 1946.

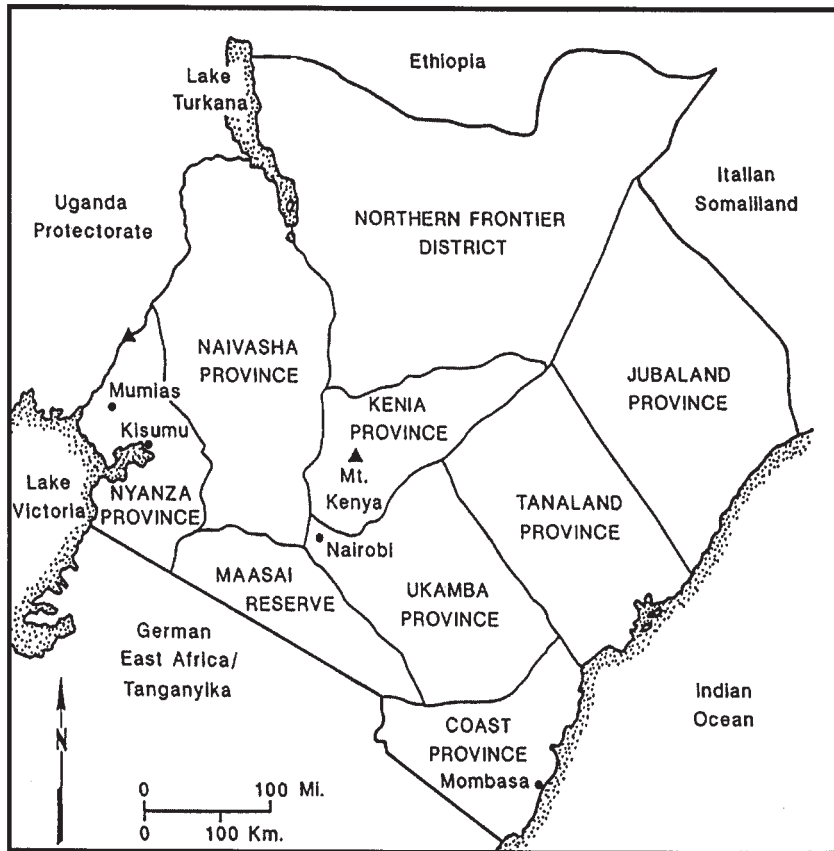

Figure 2.1: Kenya colony and protectorate map²⁴.

In 1954, the colonial administration yielded to political pressure that had started in 1940 due to economic hardships in the reserves and introduced the third formal water development plan known as “the Swynnerton Plan” under the Ministry of Agriculture. The plan was aimed at intensifying African agriculture through mixed farming featuring improved cattle for dairying and increased cultivation of cash crops²⁵.

The first rural water supplies project (Rongai pipeline) was started in 1948 with the aim of opening agriculture in the mainly European settled areas. Several rural pipelines were envisaged, these included Rongai, Vissoi, Olabanaita, Westacre, Elburgon, Enarosura, Kinja and Kinangop ring main. All of these rural pipelines were in place and operating by the end of 1959. Although the above pipelines were

24 Fielhouse D. K (1999). *The West and the Third World: Trade, Colonialism, Dependence, and Development*, Blackwell Publishers, Oxford 1999.

25 Swynnerton J. R M (1957). *Kenya's Agricultural Planning*, African Affairs, Volume 56, Number 224, July 1957.

the major ones initiated in the mainly European settled areas (with exception of Enarosura) other schemes ranging in number between 50 and 60 were developed in African areas²⁶ where the tendency was to put in a greater number of schemes of smaller dimension. Such schemes included those designed to protect water catchments by conveying piped water supplies to grazing areas sufficiently remote from important catchments to afford them protection.

The rural piping schemes were executed and operated in different ways, depending on whether they were in the old “scheduled” areas or the “non-scheduled” areas. In the “scheduled” areas, eight pipelines (Vissoi, Enarosura, Kinja, Westacre, Kinangop, Rongai, Elburgon and Olobanaita) were financed by the Central Colonial Government and installed by the Hydraulic Branch in the Ministry of Public Works. These water projects were either in the former Naivasha Country Council or Nakuru County Council areas (i.e. in the white settler farms)²⁷.

Five of the eight schemes were controlled by Associations of Operators and three were operated by the Water Development Department as normal Gazetted water supplies. However, the loan repayment position with regard to these three supplies was not the responsibility of the Water Development Department. For the other five pipelines, a loan repayment to Government was satisfactory.

According to the Water Development Department²⁸, most of the rural water supplies in the old scheduled areas ran into trouble when the European settlers sold their land to African farmers and left. Thus the association of operators and consequent difficulties in operation and maintenance, management (repayment of loan, etc.), sale of water under prevailing circumstances of settlement and changing ownership; and physical collection of revenue.

Payment of water rates and repayment of loan for rural pipes by farmers over the three operating years since the latter half of 1961 totalled £1,268, while expenditure on maintenance and incidental costs amounted to £2,876, i.e. the repayment was less than half the operating cost²⁹.

Abuse of law by the white farmers on one hand and inability to enforce the law at the detriment of the natives on the other, were demonstrated by colonel Grogon's unconcealed disregard of the Provincial Commissioner protests at Jipe farm

26 East African Standard (1959). More water for Colonies Farms. Kenya National Archives, Ref: BV/14/420. Nairobi, Kenya.

27 Water Development Department (1965). A Memorandum by the Director, Water Development Department, Ministry of Agriculture Animal Husbandry and Natural Resources. Kenya National Archives, Ref: BY/35/17. Nairobi, Kenya.

28 Water Development Department (1965). A memorandum by the Director, Water Development Department, Ministry of Agriculture Animal Husbandry and Natural Resources. Kenya National Archives, Ref: BY/35/17. Nairobi, Kenya.

29 Director, Water Development Department (1965). Rural Water Policy. Water Development Department. Nairobi.

in 1950s. The PC was unable to enforce the Wayleave License and Water permit rules against Col Grogon who built and abstracted water from Lumi River before the Water Sanction and the Wayleave license were granted. This was even before the concerns raised by other riparian holders had been satisfactorily addressed, leaving the natives bitter and angry³⁰.

By 1955, there were no formal standards of water quality laid down in Kenya and the ones which were generally adhered to were those equivalent standards applied in the United Kingdom. This was a major omission on the part of the administration that led to complaints from private individuals regarding quality.

The East Africa Royal Commission, 1953-1955, was established to guide the three East Africa territories into integrated development. The commission recommended creation of a single department in each territory to administer all aspects of water supplies, apart from urban supplies³¹.

By 1956, the Public Works Department faced problems of organisation, management and finances; the minister responsible for water policy had no control over the Hydraulic Branch and the hydraulic engineer was not in complete control of the staffing in public works department divisions. The hydraulic branch faced acute shortage of staff, which led to delays and uneconomic and unsound water development. For this purpose, Herbert Manzoni was appointed to enquire into reorganisation of Public Works Department³².

Among other recommendations, Manzoni recommended the transfer of the HB to the Department of Agriculture. Consequently, the government decided that all supplies in large towns be taken over by the Local Authorities and that the Ministry of Agriculture (MoA) should operate supplies in smaller towns³³. The proposed organisational model outlived the colonial government by 25 years.

In the early 1960s, the 'variegated' nature of the water administration in Kenya continued just like in the decades before³⁴. At this time, three sections were involved in water supplies provision, The Ministry of Works (MoW), Water Development Department and the Local Authorities. This led to duplication of duties hence inefficiency in provision of services.

30 Provincial Commissioner (1952). Wayleave –No.1 Left Bank Canal, Lumi River, Taveta. Kenya National Archives. Ca/17/116. April 4th 1952.

31 Royal East Africa Commission (1955). Kenya National Archives, AH/6/2. 1953-1955.

32 Cabinet Office (1957). Council of Ministers. Kenya national Archives, ACW/32/30. 26th March 1957.

33 Colony and Protectorate of Kenya (1957). Sessional Paper No.98 of 1957. The Manzoni Report on the Public Works Department. Government Printer, Nairobi 1957. Kenya National Archives, MSS/66/111.

34 Nyanchaga E.N & Ombongi K.S (2007). History of Water Supply and Sanitation in Kenya, 1895-2002. Environmental History of Water, Chapter 21. IWA Publishing, Alliance House, 12 Caxton Street, London UK.2007.

In August 1960, the Environmental Sanitation Programme under UNICEF commenced with the main objective to develop water supplies for the rural areas. In addition to promoting awareness in the community of the benefits of adequate and safe water supplies, this integrated programme was concerned with improved methods of waste disposal in schools, health centres, markets and public meeting places³⁵.

The Organisation of Water Supplies in Kenya, the Chief Hydraulic Engineer, Hydraulic Branch, PWD report of February 9, 1961

This report argued that water supplies especially the rural one should be organized on a regional basis. The report advocated for the establishment of a National Water Authority which would be responsible for the supply of bulk water and operation of such distribution facilities as may be feasible.

With the operationalization of the Water Act 2002 and the National water and services and sanitation strategy 2003, a new water administration structure has been promulgated, comprising of the Water Service Boards with the same responsibilities as those proposed by the Hydraulic Engineer in 1961.

Water Development and Apportionment Proposals, the Chief Hydraulic Engineer, Hydraulic Branch PWD Report of June 18, 1962

This report strongly recommended an all-purpose National Water Authority and proposed that this authority should have responsibility for planning, designing, financing, constructing, operating and managing all urban and rural water works. The responsibility of the Authority was also to include sewerage and drainage, irrigation and other water uses and include conservation, resource development, hydrology and basic data collection³⁶.

The paper also suggested the National Water Authority could at some time in the future be decentralized through the establishment of regional authorities. Such a National Water Authority was to be set up at a supra- ministerial level, with a board composed of permanent secretaries and department heads of interested ministries and would have the Head of State as Chairman.

Paper Presented by the Water Resource Authority to the Commission on the Organisation of Water Development in Kenya Paper of 1962.

35 Nyanchaga E.N & Ombongi K.S (2007). History of Water Supply and Sanitation in Kenya, 1895-2002. Environmental History of Water, Chapter 21. IWA Publishing, Alliance House, 12 Caxton Street, London UK.2007.

36 WHO (1973). Sectorial Study and National Programming for Community and Rural Water Supply Sewerage and Water Pollution Control. Report No 10. Recommendations on Administration and Organization structure for water Supply Development. Brazzaville.

This paper concentrated mainly on the rural water supplies but also touched upon matters of national organisation and development of water supplies. It is this report that marked the entry of WHO in an expert study in 1963. The major problems that affected the rural water supplies at the time included³⁷:

- Lack of coordination between Government agencies involved in community water supply sector;
- Lack of an organisation with authority on water development;
- Lack of Long-Term planning in the community water supply sector;
- Lack of data on state of water development in Kenya;
- Lack of Data on available water resources;
- Shortage of qualified Kenyan staff;
- Lack of Technical staff within the ministry of Local Government;
- Shortage of Staff for development of Lands and Settlement water schemes;
- Administration in the water development division;
- Shortage of recurrent funds;
- Shortage of development funds for urban water supplies operated by WDD;
- Low efficiency in revenue collection from the rural water supplies developed by WDD;
- Lack of inter-linkage between the development plans and the selection procedure for water schemes to be developed;
- Poor design criteria and techniques; and
- Poor purchasing procedures.

37 WHO/Government of Kenya (1972). Sectoral Study and National Programming for Community and Rural Water Supply Sewerage and Water Pollution Control. Report No 2, Recommendations on National Programme for Community Water Supply Development. Brazzaville.

2.5 Independent Kenya, Water under Ministry of Agriculture (1963–1974)

Table 2.4 provides a summary of events that were the hallmark of this period.

Table 2.4: Key water supply events between 1963 and 1974

Period	Key Water Supply Events
1963-1969	Donor community invested heavily in water resources development up to early 1980's.
1964	Water Development Department established under the Ministry of Natural Resources. Prior to 1964 Water Development had been managed by the Hydraulic Branch of the Ministry of Public Works in Urban areas, and by the African Land Development organisation in rural areas.
1965	Slogan of free basic services or services subsidised by the Government. Involvement of other actors than Government minimal. Poverty alleviation through provision of drinking water (1960s).
1968	Water Development transferred from the Ministry of Natural Resources to Agriculture. The Water Development Department took over the functions of the Water Resources Authority.
1969-1973	Second National Development Plan. Revision of the Water Act (Cap 372).
1972-1973	WHO reports on water and sanitation (12 No). Provided the direction in all aspects of water development in the succeeding years. Recommended the formation of the Ministry of Water Development.

The period beginning 1963 had a major significance to the development of water supply in Kenya. It is during this period that the institutions and their administration were handed over to the Africans. For the first time in history, the Kenyans were responsible for their own development as the colonial powers relinquished the authority to the new government.

In the water development front, regulations, development plans and policies were developed to guide the development, utilisation and maintenance of water supply systems. Rural water supplies were given a newer stronger approach and minor urban centres water supplies were considered central to the overall development of the nation. An influx of development partners and donors who assisted in technical, financial and institutional capacities was witnessed as communities were involved at grassroots level in water supply development³⁸.

³⁸ WHO (1973). Sectorial Study and National Programming for Community and Rural Water Supply Sewerage and Water Pollution Control. Report No 10. Recommendations on Administration and Organization structure for water Supply Development. Brazzaville.

The government established institutions such as the ministry of water supply and legislative framework in order to streamline the management and development of water supplies. Challenges experienced in the past were partly tackled but others persisted, new challenges also emerged calling for new approaches.

After independence in 1963, the new government used five-year development plans to harness the rapid development of the republic. The first development plan from 1964-70 was mainly a carry-over from the colonial period whose focus was economic growth³⁹. Water development was declared important for the economy, and priority was given to schemes that were expected to be financially self-sustaining, such as water services for the municipalities⁴⁰.

Report no. 10:

Administration and Organisation Structure for Water Supply Development

The report established the long-term goal of the then water development department as established by the government to be the provision of practically all the population with access to a community water supply by the year 2000. This objective has not yet been met.

The development plans adopted by the government centred on a five year periods and were defined through donor and financial agencies and also through the annual development and recurrent estimates. The report developed in 1973 after a study made a major recommendation that the water development department of the ministry of Agriculture was to be upgraded to become a separate ministry of water by the year 1978, or earlier.

The Ministry of water development was indeed formed in 1974. However, the concept of a ministry of water, or a National Water Authority had since the Manzoni report of 1957 been discussed in at least twelve reports before the WHO report of 1973. Seven of the reports had recommended a formation of National Water Authority.

To be able to see clearly the views and recommendations presented in the various reports on administration and organisation structure of water supply in Kenya, we shall examine some of the recommendations of a number of the reports:

1. THE REPORT OF PUBLIC WORKS DEPARTMENT, SIR HERBERT MANZONI, 1957

This report presented the following major recommendation on separation of the various Public Works Department (PWD), that:

39 Ochieng W. R (1995). Structural and Political Changes, in Ogot B. A. and W. R. Ochieng (eds), *Decolonisation and Independence in Kenya 1940-93*. James Currey Ltd, London, pp 83-109.

40 Government of Kenya (1964), *Development Plan 1964-1970*. Government Printers, Nairobi, Kenya.

- The Roads, Buildings and township water supply and drainage should constitute a new ministry with separate departments;
- Water conservation, irrigation and the functions of the water resources authority should pass to the ministry of agriculture; and
- As much responsibility as possible should be passed to Local Authorities as they developed capabilities and resources.

Some of these recommendations were adopted; in fact, the government adopted a policy of handing over waterworks to Local Authorities. However, contrary to the recommendations, the government after carefully studying the report decided that the hydraulic branch of the PWD should be separated and become a department under the ministry of Agriculture Animal Husbandry and Water Resources. In reality the Hydraulic Branch was separated from PWD in 1964 but did not move to the Ministry of Agriculture until January 1968.

Manzoni's recommendations were implemented in 1964 during which the Water Development Department was formed under the Ministry of Agriculture, Animal Husbandry and Natural Resources to deal with both rural and small towns. Post - independent changes were crucial due to increased water demand spurred by the population growth, urbanisation and industrialisation, and other factors that led to the expanded use of water⁴¹. Developing marginalized and neglected areas was a step to integrate the African population in the development and bring about equity in resources distribution.

Until 1964, the Hydraulic Branch of the Ministry of Works (MoW) was responsible for water and sewerage development in urban areas. Rural water development was under ALDEV of the Ministry of Agriculture (MoA). The two organisations were amalgamated under the Ministry of Natural Resources (MoNR) in 1964 and later transferred to the MoA in 1968 when the Water Development Division was established. However, the responsibility for provincial setups of the division was divided between the Director of Water Development (DWD) and the Provincial Director of Agriculture. The distribution of authority and responsibility was vaguely defined leading to persistent weakness in management of water supplies⁴².

41 Tempelhoff J.W.N (2005). African Water Histories, Vaal Triangle Faculty North-West University Vanderbijlpark, 2005.

42 WHO (1973). Sectorial Study and National Programming for Community and Rural Water Supply Sewerage and Water Pollution Control. Report No 10. Recommendations on Administration and Organization structure for water Supply Development. Brazzaville.

2. THE ORGANISATION OF WATER DEVELOPMENT IN KENYA, (WHO/FAO CONSULTANT TEAM), MAY 1963

This report strongly recommended the forming of a National Water Authority. The authority was to be responsible to the parliament through the responsible minister. It recommended the unification of the technical services dealing with water supplies of all kinds.

The setting up of a separate technical water development department under the ministry of Natural resource, composed of the former Hydraulic Branch of the Ministry of Works plus the existing technical unit of the African land development Board (ALDEV), was in fact the first stage in the implementation of that report. The second stage, that is the implementation of the National Water Authority, was deferred until the reports of the Government working party of statutory organisations and of a commission of enquiry on local government had been presented.

3. DRAFT REPORT OF THE WORKING PARTY ON THE NATIONAL WATER AUTHORITY, 13 DECEMBER 1967

Several working parties were constituted to look into the recommendations made in the 1963 WHO/FAO report. This particular working party was reconvened in 1966. Their report recommended on organisational structure, functions, powers, legal status, cost implication and proposed legislation for the establishment of the National Water Authority. The report also delved in to the issue of the relationship/interaction of the proposed authority and certain existing water supply operations.

Although the government was principally in agreement with the formation of a National Water Authority, there were diverse opinion on the functions of the authority and the Treasury was not represented on the working party having indicated that they could not actively participate in the deliberations as there was no immediate prospect of funds being available to form the National Water Authority.

4. “THE RE-ORGANISATION OF THE WATER DEVELOPMENT DEPARTMENT OF THE MINISTRY OF AGRICULTURE” OLLE RIMER (SWEDISH AID) 31ST AUGUST 1968

The report dwelled on the efficient running of the department, internal re-organisation, coordination of water supply development and the importance of preparing a Master plan.

Some of the recommendations made in this report include:

- Coordination and co-operation between interrelated ministries rather than the formation of the National Water Authority; and

- The staff of the water development department be brought to full authorized strength before further consideration was given to forming a National Water Authority.

5. “EXPLANATORY NOTES AND FUNCTIONAL STATEMENTS ON THE RE-ORGANISATION OF THE MINISTRY OF AGRICULTURE”, J.B. SEAL (FORD FOUNDATION), STAFF UTILISATION ADVISOR TO THE OFFICE OF THE PRESIDENT, NOVEMBER 1968

The report provided the following recommendation: The water development department be downgraded to a division, which was implemented to the letters. The water development division became a functional division of the ministry.

The division lost control of its own administration, finances and field functions (both technical and operational) as they became the responsibility of the Provincial Directors of the Ministry of Agriculture.

6. NATIONAL WATER DEVELOPMENT PROGRAMME FOR COMMUNITY WATER SUPPLIES IN KENYA, M. LIEBERMAN, J. VINCENZ AND H. OSTER (WHO) 1969

The report advocated for the formulation of a National community water supply programme with an Agency charged with the responsibility of implementing the programme. The agency was to be provided with the necessary legal powers and financial resources.

After the failure to establishing the National Water Authority, the advocacy for an agency to implement community water projects was done with caution. The proposed agency was suggested on the lines of replacing the earlier idea of a National Water Authority. The Agency would have strong co-ordinating powers and be a quasi-independent organisation with national responsibilities for water development regardless of the ministerial portfolio in which it was to be placed. It was to have full authority over its own staffing, policies, and training, administration and field operations. The urgency of forming the Agency was stressed.

7. COMPREHENSIVE WATER RESOURCES PLANNING IN KENYA,” G.B. MAXEY AND R.E. SAVISARI (UNDP CONSULTANTS) (9 JULY 1971)

The study objective was the long term rural water development, the institutional arrangements in the country for planning, development and managing water resources programme. The major recommendations include:

- Preparation of a national water and related land resources plan;
- Development of a responsible organisation such as a National Water Authority, of supra ministerial and parastatal level; and

- An operational organisation to develop and manage the water resource of Kenya be created at ministerial level incorporating the new existing water development division of the ministry of agriculture, which would at a later date become the operating arm of the proposed National Water Authority.

8. “A NATIONAL COMPREHENSIVE WATER RESOURCES PLANNING PROJECT FOR KENYA,” G.B. MAXEY AND R.E. SAVISARI (UNDP CONSULTANTS) (9 JULY 1972)

The report emphasized the establishment of a supra-ministerial, parastatal Agency mentioned in the 1971 report and added that such a Government agency did not exist and needed to be established.

The reports pointed out that the functions of such an agency would not be restricted to water resources planning, but would also include overall administrative and executive control of water resources, policy development and private organisations. It was to coordinate all government efforts in this field. The report stressed that the division could not itself act as Government agency, although selected staff could act as staff for the agency.

9. FINAL REPORT OF THE SURVEY MISSION ON THE TANA RIVER BASIN BY HOWE C.W. (UNDP CONSULTANT), 31ST JANUARY 1972

The mission’s work coincided with the Maxey and Savisaari mission and both missions were coordinated.

The Howe study was to lead to a comprehensive, integrated plan for the development of water supply, irrigation, flood control, hydro-power, agricultural land use and other services required for future growing population and commerce in the basin. The work of this mission was rather regional.

The mission recommended the formation of Tana River Basin Planning and Implementation Agency, which later became the Tana River Development Agency. The relationship of this agency and the proposed National Water Authority was discussed and it was demonstrated that the functions of the two would not conflict. In certain areas, the agency would be subject to the authority while at the same time the authority would have to depend on the agency for advice as regards the Tana River Basin.

On account of the foregoing excerpts it is clear that the overall responsibility for water development has shifted between ministries over the years.

Until 1964, the Hydraulic Branch of the Ministry of Works was responsible for water and sewerage development in urban areas. Rural water development was one of the responsibilities of the African Land Development (ALDEV) of the Ministry of Agriculture.

The two organisations were amalgamated to form the Water development department in 1964 under the Ministry of Natural Resources. The department was transferred to the Ministry of Agriculture in 1968 and subsequently became the water development division. Responsibility for the Provincial organisations of the division was divided between the Director of Water Development Department and the Provincial directors of agriculture. The distribution of authority was only vaguely defined and caused considerable unease among the provincial organisations.

In 1972, the status of the organisation was restored to that of the Department and the Director again became directly responsible for the provincial organisations. In 1973 the water development department had overall responsibility for water development in Kenya. Specialized agencies handled responsibility for certain sectors namely; National irrigation Board handled the major irrigation developments and the Hydro-electric power was handled by the Ministry of Power and Communications.

Water permits which were required for all surface water abstractions were issued by the water apportionment board, which was responsible to the minister for Agriculture. The quantity and quality of water to be supplied, and disposed of, and the means and location of its abstraction, was stipulated in the permits. The Director of the water development department was the chief Technical advisor to the Board.

The water resources authority, with advisory functions on all aspects of water use, was established in 1951 and de-gazetted in 1972, after several years of inactivity. The water department took over the functions of the water resources authority. The Water Act was later to be amended to this effect⁴³.

At the time there existed the Water and Sewerage Department within the Nairobi City Municipal Council, which was directly under the Ministry of Local Government but had an autonomous position vis-à-vis the Ministry.

The Ministry of Local Government in 1973 operated seven major urban water supplies, all sewerage schemes in urban areas through town councils, and a large number of rural water supplies through the county councils. The water development department was responsible for advising the Ministry of Local Government on all matters concerning community water supply, sewerage and water pollution control. The Mombasa water supply was operated by the water department, which bought water in bulk from the Mombasa pipeline Board, a statutory body created in 1957 and reporting to the Ministry of Agriculture. The water department operated and maintained installations owned by the Board on an agency basis.

43 Water Development Department (1965). A Memorandum by the Director for Water Development Department, Ministry of Agriculture Animal Husbandry and Natural Resources. Kenya National Archives, Ref: BY/35/17. Nairobi, Kenya.

Since 1963, the Ministry of Lands and Settlement was engaged in executing a rural water development programme in settlement areas through finance from the World Bank, the British and West German governments and Technical Assistance from the water department. Most of the water supplies were operated the co-operatives in the settlement areas; they had problems in obtaining trained operators to run the supplies. Many schemes were under-designed, resulting in lower quantities of water supplied than initially intended. Practically all schemes were based on individual connections and water charges were high.

The Ministry of Health was responsible for water supply quality surveillance in the country. With assistance from UNICEF and WHO, the Ministry carried out a rural water development programme over a ten-year period, with the main aim of demonstrating the benefits of rural water supplies and creating development interest in this development among the rural population. In 1973 the Water Development Department launched a massive rural water development programme. Most of the water supplies developed by the WHO/UNICEF programme were handed over to the county councils (formerly African District Councils), many of which did not have adequate resources to maintain them. The problem was aggravated by the fact that many of the systems were not adequately designed

An Inter-Ministerial Committee for Rural Water Supply development was created in 1969. All government agencies concerned with rural water development were represented on the committee, which was chaired by the deputy secretary to the Ministry of Agriculture. The main function of the committee was to review the rural water development programme set up by the water development department⁴⁴.

As years went by, the number of water supplies managed by the public works kept increasing and putting a strain on the public works department. The only way to shed off some of the responsibility was to hand over some of the water supplies to Local Authorities in some townships where administration had been properly established. In the 1960's a sizeable number of water supplies, for example, Kitale, Naivasha, and Kapenguria were handed to the Local Authorities. Other water supplies such as The Webuye water supply that could not get an undertaker for operation and maintenance.

When rural water pipelines were developed the public works department had already foreseen the problem of management and encouraged consumer to form what was known as the Association of Operators to take up and manage the pipelines

⁴⁴ Water Development Department (1965). A Memorandum by the Director for Water Development Department, Ministry of Agriculture Animal Husbandry and Natural Resources. Kenya National Archives, Ref: BY/35/17. Nairobi, Kenya.

once they were complete⁴⁵. However, some rural water supply schemes did form these associations and managed the water supplies but some just could not commit themselves for various reasons.

In 1964 county councils were involved in the management of water supplies especially the rural ones which had been left behind by the white settlers after independence. However, even before independence some water supplies were managed by Local authorities. Some good examples of such local authorities are the Nairobi, Eldoret, Nakuru Kisumu and Mombasa where municipal boards were formed quite early.

In spite of who was the undertaker of a water supply the problem emanating from poor collection of water rates led to poor maintenance and deterioration of most of the water supplies. After independence water was taken as a social good and water supplied was not paid for. This created a situation where water supplies could not be sustained due to lack of money for operations and maintenance as well as accumulated unpaid loans. A good example is the Kibichori water supply in Bungoma district⁴⁶.

In 1971, WHO carried out a sectorial study for community and rural water supply to establish the general community water supply problems. Most of the problems were associated with finance, manpower and administrative procedures. Lack of coordination between government agencies, lack of an organisation with authority on water development, lack of long-term planning, inadequate data, shortage of qualified Kenyan staff, and poor design criteria and techniques were some of the problems cited⁴⁷

Inter-Ministerial Committee for Rural Water Supply, was established in February 1969, a decision that was made by the Cabinet in order to accelerate the rate of community development. The committee had mandate to make recommendations and report to the Minister for Agriculture on financial policy, water charges, rate collection, scheme selection criteria and evaluation of rural water development among others⁴⁸.

In 1972, the Water Development Division was elevated to a Department and the Director of Water Development became directly responsible for the provincial organisations. The Water Department was given the overall responsibility for water

45 Water Development Department (1965). A Memorandum by the Director for Water Development Department, Ministry of Agriculture Animal Husbandry and Natural Resources. Kenya National Archives, Ref: BY/35/17. Nairobi, Kenya.

46 Water Development Department (1965). A Memorandum by the Director for Water Development Department, Ministry of Agriculture Animal Husbandry and Natural Resources. Kenya National Archives, Ref: BY/35/17. Nairobi, Kenya.

47 WHO (1971). Sectorial Study and National Programming for Community and Rural Water Supply Sewerage and Water Pollution Control. Report No.1. General community water supply problems, Brazzaville.

48 WHO (1971). Sectorial Study and National Programming for Community and Rural Water Supply Sewerage and Water Pollution Control. Report No.1. General community water supply problems, Brazzaville.

development in the country⁴⁹. The Ministry of Local Government (MoLG) was in charge of water supplies in major municipalities⁵⁰.

2.6 Water Services under Ministry of Water Development (1974–1986)

Table 2.5 illustrates a summary of major events that influenced the direction of water supply in Kenya in the period 1974–1986.

Table 2.5: Key water supply events between 1974 and 1986

Period	Key Water Supply Events
1974-1978	Third National Development Plan which emphasized the: Need to manage the re-sources for ecological, socio-cultural and economic benefits. Recommended that a system of user charge to be established in the sector. Rates for urban water supply and sewerage recommended to be based on full cost recovery. MoWD takes over self-help water supplies and County Council water supplies. Local Government Act (Cap 265), revised 1986. Establishment of Local Government Loans Authority (LGLA).
1978	Water and Sanitation Departments (WSD) in Local Authorities.
1974 to 1990	Post-Independence: Water Act Cap 372 enacted, Water Services under the created Ministry of Water Development.
1976-1981	First National Water Master Plan supported by SIDA.
	Sustainable management of water as a limited natural resource.
1981	Legal Notice No. 194, December 1981. Ministry of water development standardized water tariff throughout the country and abolished metered connections in the rural areas.
1979-1983	Fourth National Development Plan. Policy change: “everybody should pay for water services”. “Water for all by 2000”.
	Structural Adjustment Programmes (SAPs), from 1980/81. “Restoring efficiency in all sectors of economy, including water”. Attempts to restructure LGLA along the lines of municipal development bank.
1983 -1988	Legal Notice No. 194, December 1981 was not withdrawn even after the publication of Sessional Paper No. 1 of 1986 that introduced cost recovery in provision of social services.
1986	Paper for Economic Management for Renewed Growth (Sessional Paper No. 1).
	Commercialisation of water and sanitation facilities.
	Decentralisation of water provision to Local Authorities.

49 WHO (1972). Sectorial Study and National Programming for Community and Rural Water Supply Sewerage and Water Pollution Control. Report No 2. Recommendations on National Programme for Community Water Supply Development. Brazzaville.

50 WHO (1973). Sectorial Study and National Programming for Community and Rural Water Supply Sewerage and Water Pollution Control. Report No 10. Recommendations on Administration and Organization structure for water supply development. Brazzaville.

In November 1974, a fully-fledged Ministry in Charge of Water affairs was created a year after the recommendation by WHO. In effect, therefore, the government was in agreement with WHO that water was not receiving the attention it deserved under the MoA.

The Government's decision to create such a Ministry was due to the increasing awareness that water supply and environmental sanitation were the biggest contributors to acceptable health standards. One of the Ministry's first decisions was to take over the management of not only government operated water schemes but also self-help and County Council operated schemes. Within its first decade of creation, major development programmes to provide improved water supplies to the people in rural areas and improvement and extension of services in the urban areas were undertaken⁵¹.

The first attempt to coordinate and streamline planning in the water and sanitation sector came as early as 1974 when the First National Water Master Plan, developed with assistance from the government of Sweden was launched. Implementation of the master plan was not effective because government development activities were then based on project approach, perceived to have several weaknesses that included, piecemeal planning, donor-driven investments, little incentive to minimize costs, compromised technical standards and gradual undermining of government systems especially at local level⁵².

Ministry of Water Development: Indeed, within its first decade of creation, major development programmes to provide improved water supplies to the people in rural areas and improvement and extension of services in the urban areas were undertaken⁵³.

Table 2.6 illustrates the water supplies operated by the department at the time it was elevated to a full-fledged Ministry⁵⁴.

51 WHO (1973). Sectorial Study and National Programming for Community and Rural Water Supply Sewerage and Water Pollution Control. Report No 10. Recommendations on Administration and Organization structure for water supply development. Brazzaville.

52 Ministry of Water and Irrigation and Water and Sanitation Program-Africa, (2007). Kisima, World Bank, Nairobi, Issue 4. January 2007.

53 WHO (1973). Sectorial Study and National Programming for Community and Rural Water Supply Sewerage and Water Pollution Control. Report No 10. Recommendations on Administration and Organization structure for water supply development. Brazzaville.

54 WHO (1973). Sectorial Study and National Programming for Community and Rural Water Supply Sewerage and Water Pollution Control. Report No 10. Recommendations on Administration and Organization structure for water supply development. Brazzaville.

Table 2.6: Water supplies operated by water department in early 1974

Province	Type of supply				
	Urban	Rural	Institutional*	Non-gazetted	Total
Central	13	3	11	-	27
Coast	19	6	1	-	26
Eastern	8	10	1	5	24
North-Eastern	1	19	1	-	21
Rift Valley	25	15	19	1	60
Western	7	5	4	-	16
Nyanza	10	2	2	1	15
Nairobi Extra	12	6	33	-	51
Total	95	66	72	7	240

*For some of the institutional supplies, the water department was only carrying out maintenance and were operated by other agencies.

In the early part of the 1970s, the Government recognized the crucial role played by the water sector for the general economic growth of the country. Under the new Ministry, a new plan of action was established aimed at improving efficiency and extending in the water services to as many citizens as possible. This increased access to water tremendously in the rural areas.

During the start of the post independent period, the water sector in Kenya was characterised by very poor financial performance, and as a consequence, services could not be expanded as planned. The government was far from being able to uphold its promise of Water for all by 2000⁵⁵. By the 1990s, it emerged that the government lacked sufficient resources to match communities' water needs. This culminated in the National Policy on Water Resources Management and Development Sessional Paper No. 1 of 1999, which was first drafted in 1992. Other policy blueprints include the Water Act 2002, the Country Strategy on Water and Sanitation Services and Country Strategy on Integrated Water Resources Management⁵⁶.

The post independent administration further introduced major institutional changes in Kenya. The District Focus for Rural Development Policy introduced in 1983 provided the framework of decentralized government. Sectoral department were officially represented throughout the hierarchy of district, divisional and locational administrative units. This led to customary right to water notion proving not only flexible but also ambiguous. A key issue was the extent to which processes of commoditisation of access to water were contested or accepted⁵⁷.

55 Nilsson D and E Nyangeri Nyanchaga, 'Pipes and politics. A century of change and continuity in Kenyan urban water supply'. Forthcoming article.

56 Wambua S. (2004), Global Issue Paper, No. 8: Water Privatization in Kenya, Heinrich Boll Foundation. March, 2004.

57 Bernstein H., Hulme D. and Woodhouse P. (2000). African Enclosures? The social Dynamics of Wetlands in Drylands. Oxford: James Currey, 2000.

By late 1970s, development agencies had realized that the ministry could not continue with business as usual. The ministry agreed with their observation and as a result a number of studies supported by SIDA were commissioned. The water use study of 1983 argued that the MoWD should be divested of operation and maintenance responsibilities. Similarly, the operation and maintenance study of 1983 made strong representations in favour of decentralisation. In effect, therefore, these reports called for reforms revolving around the initiation of changes in the management of schemes with a view to: enabling the MoWD gain effective control over its schemes; decentralizing management, operation and maintenance to appropriate levels for rapid and effective response to scheme specific happenings; increasing the level of consumer participation and responsibility in the management; increasing the level of equity in the social distribution of scheme waters; and generating resources needed for operation and maintenance from the consumer.

These reports, however, warned that without these reforms the water sector shall increasingly find it difficult to operate and maintain the schemes; and generate the resources required for the much needed expansion of its investments to reach the majority of population without access.

Since its inception, the Rural Water Supply (RWS) Programme lagged behind schedule. The status of the three RWS programmes at various stages in their implementation was as follows. By 1976, RWS I was virtually complete with 97 percent of construction expenditure committed for the RWS II 69 percent of the schemes were completed and 70 percent of planned population being served. Ninety-one percent of the planned construction expenditure had been committed in RWS III⁵⁸.

Rural Water Supply I: By January 1977 five RWS I projects were still under construction according to MWD. Three of these were in North Eastern Province where lack of suitable water sources had compounded planning and design problems. In addition, long distances had aggravated construction delays. At the uncompleted scheme in Rift Valley about 90 percent of the planned construction was committed and in Eastern Province a small scheme planned to serve 1000 people at a cost of KES 40,000 had only been started. However, these schemes were expected to be completed by mid-1977⁵⁹.

Rural Water Supply II: By March 1976, no scheme was completed. This was mainly due to the backlog of the earlier programmes, and the apparent discrepancy

58 Republic of Kenya (1977). Evaluation of the Rural Water Supply Programmes I, II, III. Volume I, Summary. Ministry of Water Development, Nairobi.

59 Republic of Kenya (1977). Evaluation of the Rural Water Supply Programmes I, II, III. Volume I, Summary. Ministry of Water Development, Nairobi.

between expenditure and completed schemes was partly due to a rescheduling of the construction programme. By January 1977, two schemes were completed, while 5 schemes were due to be completed by end of February 1977. The MWD anticipated that the programme would be completed by 1980⁶⁰.

The causes of programme delay fell into two categories, exogenous (outside the government control) and endogenous (under government control). Each category was further subdivided into:

Exogenous factors: (a) outside Kenya which included delivery (late delivery of materials on international tenders and shortage (world shortage of materials, particularly pipes and fittings in 1973). (b) Within Kenya which included material (non-availability of materials and equipment) and weather problems.

Endogenous factors: (a) within the government which included tendering procedures, import restrictions, transport and accounting procedures, (b) Within MWD, including material purchasing, accounting, administration and transport and lack of skilled manpower and supporting⁶¹.

Cost overruns: For RWS I, the overall scheme cost increase over the planned expenditure for complete scheme was 95 percent which ranged from 500 percent above to 50 percent below planned cost. For RWS II the mean cost increase was 59 percent, ranging from 450 percent above to 30 percent below planned cost. The main reasons for the cost increase were inadequate planning data, scheme redesign and increased cost of material and labour. However, the impact of externally generated inflation on the programme was aggravated by implementation delays which resulted in much expenditure being incurred during the period of most rapid inflation⁶².

60 Republic of Kenya (1977). Evaluation of the Rural Water Supply Programmes I, II, III. Volume I, Summary. Ministry of Water Development, Nairobi.

61 Republic of Kenya (1977). Evaluation of the Rural Water Supply Programmes I, II, III. Volume I, Summary. Ministry of Water Development, Nairobi.

62 Republic of Kenya (1977). Evaluation of the Rural Water Supply Programmes I, II, III. Volume I, Summary. Ministry of Water Development, Nairobi.

2.7 Water Services under Ministry of Water Development (1987 – 1999)

Table 2.7 illustrated the key water supply events in the period between 1987 and 1999.

Table 2.7: Key water supply events between 1987 and 1999

Period	Key Water Supply Events
1987	Policy of assisting water undertaking in Local Authorities to improve management and sanitation services.
	Genesis of institutional reforms. GTZ assistance under Kenya German Water Team started in 1981
1988	Establishment of National Water Conservation and Pipeline Corporation (NWCP) through legal notice No. 290 of 1988.
	Legal notice rendered Mombasa Pipeline Board Act 373 inoperable.
	Objectives: To commercialise water sector operations, to achieve financial autonomy in water operations, to improve performances and efficiency of water schemes and to reduce dependence on public funding of independent water schemes.
1989-1993	Water charges, the proposal on the consumer ability to pay when establishing charges and rules for their application.
	Coverage targets established: rural WS from 26 % to 50 % by 1993, urban WS from 75 % to 95 % by 1993.
1991	Urban Development Department (UDD) created within the Ministry of Local Government.
1990-1992	Second National Water Master Plan supported by JICA. Focused on technical issues. Yet: long-term plan for reforms (water pricing and legal framework).
	Demand-Driven Approach (DDA) strategy in use.
	Establishment of Water and Sanitation Companies (under Companies Act, Chapter 486).
1994	National Environmental Action Plan developed that promoted incentives for recycling water.
1994-1996	Seventh National Development Plan. The objective was to ensure water resource conservation and management.
1999	National Policy on Water Resources Management and Development (Sessional paper No.1) Separation of water resource management from service provision.
	Rural water supplies managed by communities, urban water supplies managed by local authorities and NWCP.
	Preparation of National Water Policy begun in 1996. Policy Framework Paper on Economic Reforms for 1996-1998.
	Aftercare study of 1998 on National Water Master Plan: envisaged 100 % access by 2010.

On June 24th 1988, through Legal Notice No. 270, the President ordered that the National Water Conservation and Pipeline Corporation (NWCPC) be established, under the State Corporations Act. The NWCPC was to operate those water supplies placed under its care on commercial basis. The main objectives were: to commercialise water sector operations, to achieve financial autonomy in water operations, to improve performances and efficiency of water schemes and to reduce dependence on public funding of independent water schemes.

The First National Water Master Plan (NWMP)⁶³ was developed in 1979 through Swedish assistance and remained the main guiding plan for water development until 1992 when Japan International Corporation Agency in conjunction with Kenya Government formulated the second NWMP⁶⁴. This is still the guiding document to water development to date. Up to early 1990s, the implementation of rural water supplies was based on supply-driven approach (SDA) development strategy with high construction targets that left little opportunity for community involvement. The SDA strategy was found to be non-viable and thus a demand-driven approach (DDA) strategy was introduced⁶⁵.

These systems supplied water services to a total of about 18.6 million people, which meant average service coverage of 59 per cent of the estimated total population of 31.6 million people⁶⁶.

Table 2.8 presents the number of water supply systems in Kenya by the year 2000 managed by various agencies. These systems supplied water services to a total of about 18.6 million people, which meant average service coverage of 59 per cent of the estimated total population of 31.6 million people⁶⁷.

63 Republic of Kenya (1979). First National Water Master Plan. 1979.

64 Republic of Kenya/Japan International Cooperation Agency (1992). The Second National Water Master Plan. 1992, Nairobi, Kenya.

65 Skyttä, T. K Ojanpera, S. and Mutero, J. (2001). Evaluation of Sector Performance. Report of Evaluation Study. Finland's Support to Water Supply and Sanitation 1968-2000. Unit for Evaluation and Internal Auditing, Ministry of Foreign Affairs, Department of International Development Cooperation. Helsinki, Finland. April 2001.

66 Aide M'emoire (2000). Review of the Water Supply and Sanitation Sector. Republic of Kenya. Joint World Bank, KFW, GTZ and AFD Mission. December 2000.

67 Aide M'emoire (2000). Review of the Water Supply and Sanitation Sector. Republic of Kenya. Joint World Bank, KFW, GTZ and AFD Mission. December 2000.

Table 2.8: Number of water supply systems by service provider and population served

Service provider/producer	Number	Population served (x10 ⁶)
Ministry of Water Resources Management and Development	628	6.1
National Water Conservation and Pipeline Corporation	48	3.7
Communities	356	14.9
Non-governmental organisations	266	
Local authorities	243	
Total	1 549	18.6

In the late 80s, there was a break with past policies with more emphasis being put on participation for progress and resource mobilisation for sustainable development. It can actually be argued that after 1988, rural development was no longer of central focus in policy circles. Instead, there was movement towards cost sharing, retrenchment, sale of parastatals and privatisation of some government functions, price and import decontrols, removal of government subsidies, and budget rationalisation away from social programmes⁶⁸.

By 1993, the SIDA point of view was: emphasis on projects involving communities, financial management to the communities and other organisations, and support to NGOs and sub-sectors which were very successful⁶⁹.

The above shift became necessary in the face of an economic recession characterised by low growth rates, dwindling public resources and reduction/discontinuation of donor aid. During this same period, Non-Governmental Organisations (NGOs) became increasingly present as key players in the development process. The Kenya government development plan (1994-96) sought to restore economic growth and foster sustainable development. In addition, even though the plan intended to build on past experience, its main aim was to adopt (new) policies that would enable Kenyans to best cope with the changing economic and social conditions of the last five years. Hence, there was intention to limit direct participation in many spheres of the public sector in favour of private sector activity. Government however recognised that although the structural adjustment programmes were expected to bring about growth in the long-term, these policy changes had, in the short run exposed the poor to high levels of risk.

The reforms were accused of having taken away basic welfare from the poor by instituting cost-sharing in basic services such as health, water and education⁷⁰. These measures were said to have accentuated the plight of the poor who formed

68 Republic of Kenya (1994) Development Plan 1994-96. Nairobi: Government Printers.

69 Republic of Kenya (1993). Report on the 1993 Provincial/District Water Engineers' Conference. Ministry of Land Reclamation, Regional and Water Development. 18th -20th August 1993.

70 Republic of Kenya (1994) Development Plan 1994-96. Nairobi: Government Printers.

46 percent of the rural population. Hence, in its 1994/95 budget, the government made a provision to address the social dimensions of development to cushion the poor from the effects of structural reforms. In addition, in order to increase its opportunities, government called upon Non-Governmental Organisations (NGOs) and the donor communities to support initiatives aimed at addressing the offshoots of structural reforms⁷¹.

By the year 1994, it was a common knowledge that most local authorities in Kenya were experiencing difficulties in management of water supply and sanitation services. As the population grew in local authorities, the demand for those services increased thus making the management much more difficult. In addition, inefficiency and laxity crept into most of the local authorities which contributed to management problems of these vital services. Most local authorities in Kenya had not embraced the commercialisation of water supply and sanitation services as an approach to minimizing the inefficiency and enhancing the effectiveness of the councils. Proper financial management within the concept of commercialisation was the key factor in improving water service delivery. Consequently, a training programme on financial management was carried out in the period between September 1994 and March 1995. The programme was intended to bring efficiency and effectiveness in the operations of water service delivery by enlightening the water service delivery staff and entire council on the policies and procedures of operating the WSD in conformity with the Local Government Act, the Controller and Auditor General Requirements and other relevant laws pertaining to Local Authorities⁷².

Non-governmental organisations (NGOs) participated in the development of community water supply and sanitation both in rural and urban areas. NGOs have been acting as important mediators in the process of rural development over the last decade in Kenya. They have been widely acclaimed as ‘agents of change’, acting as ‘catalysts’ in development; they are not only entering into partnership with national and international agents, but also are pioneering new techniques and approaches in participatory methods at the grass-roots level. As an effective ‘buffer’ between the state and the people, they have been able to gain the confidence of both sides and to act as intermediaries in bringing the development message ‘down’ to the communities. Small private non-profit organisations interested in the welfare of the people have thus been able to circumvent the bureaucratic process and to act rapidly and efficiently in times of crises. They have earned a high reputation for accountability,

71 Republic of Kenya (1994) Development Plan 1994-96. Nairobi: Government Printers.

72 Ministry of Local Government, Urban Development Department (1994). Training Programme, Financial Management: Local Authority Water Supply and Sanitation Services September 1994 –March 1995. GTZ/MOLG Urban Water Supply and Sanitation Management Project. Nairobi Kenya.

thereby forming channels for donor and international agency funding. As a result, they have increasingly been entrusted with supporting development projects in the country⁷³.

2.8 Actualisation of the Water Sector Reforms (2000–2003)

A summary of key events that drove the Kenya water sector is demonstrated in Table 2.9.

Table 2.9: Key water supply events between 2000 and 2003

Period	Key Water Supply Events
2000	Draft Poverty Reduction Strategy Paper.
2001	Country Strategy on Integrated Water Resources Management.
	Country Strategy on Water supply and Sanitation Services.
	Increasing role for the private sector in the service delivery.
	Establishment of Water Services and Sanitation Companies.
2002	Parliament enacted a new Water Act (October 2002). Water Act 2002 published.
	Act repeals Water Act 372 (last revised in 1972) and some sections of local government Act Cap 265 that deal with water and sanitation services.
	Transition Plan for Implementation of Water Act.
	Establishment of Water Sector Reform Secretariat (WSRS) and Steering Committee (WSRSC).
	Establishment of Water Services Boards (WSB) (Nairobi).
	Water Services Regulatory Board (WSRB) gazetted.
2003	Ministry of Water Resources Management and Development
	Water Services Trust Fund (WSTF) gazetted.
	Established National Water Services Strategy (NWSS).
	National Water Resources Management Strategy (NWRMS).

The 2002-2008 National Development plan⁷⁴ indicated that about 75 percent and 50 percent of the country's urban and rural population respectively had access to safe drinking water. This was achieved through provision of some 330 gazetted water sources countrywide, accounting for 80 percent of the served population; while the rest (20 percent) of the population was served by non-gazetted schemes. There are over 1,800 water supplies that are operational out of which about 1,000 are public operated schemes. Non-Governmental Organisations, self-help groups

⁷³ Ministry of Water Development, Kenya and Swedish International Development Authority (1992). Delineation Study, the Water Sector in Kenya, July 1992.

⁷⁴ Republic of Kenya (2002a). National Development plan 2002-2008. Effective Management for Sustainable Economic Growth and Poverty Reduction. Government Printers, Nairobi, Kenya.

and communities run the rest. Similarly, there exist about 1,782 small dams and 669 water pans in the country of which 1,183 are operational and 1,168 silted but operational; 100 have dried up or have been abandoned. In addition, there exist about 9,000 boreholes the majority of which require rehabilitation or replacement.

The Development plan⁷⁵ indicated further that out of the 142-gazetted urban areas in Kenya, only 30% had sewerage systems. According to Nippon Koei⁷⁶, majority of sewers constructed in the 1950s, 60s and 70s and have never been inspected and are in poor structural condition. Development has exceeded the available hydraulic capacity of older sewers resulting in frequent blockages, overflows and surface flooding. This situation has posed serious environmental and health problems with main sewer systems in most urban centres suffer from constant breakage or leakage, inadequate capacity to handle their full sewerage load. A number of factories and enterprises are known to discharge effluents through mainstream rivers and valley depressions causing high pollution levels. Thus, effluent pollution makes rivers, streams and dam water unsafe for domestic and livestock consumption.

Kenya Railway: Although the railway developed most of its water supplies in the nascent years of colonialism, this did not deter it from extending its distribution system over the years and as late as the 1980's the railway was still providing water to both its employees and the public. The railway also participated in the development of major water pipelines like Kilimanjaro (Nol-Turesh Pipeline), the Ngong - Magadi Pipeline in 1915 as well as the Mzima springs Pipeline to Mombasa. However, the railway handed over most of its water supplies in 1980's to the Ministry of Water Development with the exception of a few such as like the Nanyuki Water Supply⁷⁷. This was especially occasioned by the development of petrol/diesel driven engines, which led to the steam engines being phased out. Thus, the Kenya Railway found itself using little of its water system and hence the handing over.

Ministry of Health: From 1960 to 1972, UNICEF provided assistance to the programme in the form of mechanical water pumps and diesel engines to power them, hydrams, hand pumps, piping and related materials such as asbestos-cement

75 Republic of Kenya (2002a). National Development plan 2002-2008. Effective Management for Sustainable Economic Growth and Poverty Reduction. Government Printers, Nairobi, Kenya.

76 Nippon Koei (1998). The Aftercare Study on the National Water Master plan in the Republic of Kenya. Final Report, Executive Summary. Japan International Cooperation Agency, Ministry of Water Resources, Republic of Kenya. November 1998.

77 Kenya Railways head office records. The Kenya railways water supplies register.

roofing sheets for rain catchment at schools. The WHO provided engineers and health inspectors as technical advisers to the programme⁷⁸.

Initially, UNICEF aid was being matched by contributions from the local communities in the ratio of 60 to 40 percent respectively. The latter contributed labour and materials as well as money. At the beginning of fiscal year 1970, the central government began contributions to the programme. UNICEF assistance decreased thereafter and ceased at the end of fiscal year 1972 with the central government and the local communities now sharing the costs⁷⁹.

At the time of UNICEF's withdrawal, some 561 rural water supply schemes throughout the country had been completed or were being designed and initiated. They were designed to provide a piped water supply to an estimated population of 664,000. The work was carried out in nine phases over a thirteen-year period. Authorities agreed that this had had the desired effect of showing the benefits of a permanent, safe water supply in the rural areas. Numerous communities in the country started organizing committees to develop their own water supplies⁸⁰.

Staffs were trained to follow a standard design system, including hydraulic calculations, costs and submission methods. For reasons of standardisation, all equipment used in the programme was generally of one make.

In 1974, UNICEF carried out a follow up study of the projects it had implemented covering 197 out of 561 schemes in eleven districts and six provinces. Some of the problems encountered by the Rural Water Supplies Demonstration Programme are as outlined below⁸¹:

1. **Operation and Maintenance:** Many of the schemes found not operational during the evaluation were due to lack of funds to buy spares, fuel and lubricating oil, and employ a permanent pump attendant.
2. **Lack of transport:** Transport of parts or material to make repairs was often lacking.
3. **Lack of standard procedure for operating and maintaining a supply:** Supplies using mechanical pumps and engines were affected as the Ministry of Health had no training school for pump and engines users.

78 Wignot (1974). A report on the condition of UNICEF assisted demonstration rural water supplies in Kenya. UNICEF regional office, Nairobi.

79 Wignot (1974). A report on the condition of UNICEF assisted demonstration rural water supplies in Kenya. UNICEF regional office, Nairobi.

80 Wignot (1974). A report on the condition of UNICEF assisted demonstration rural water supplies in Kenya. UNICEF regional office, Nairobi.

81 Wignot (1974). A report on the condition of UNICEF assisted demonstration rural water supplies in Kenya. UNICEF regional office, Nairobi.

4. **Failure of water source:** Along the coastal hinterlands, several dry years resulted in the drying up of wells and springs and streams and the abandonment of water supplies dependent on these sources.
5. **Sabotage or theft of materials:** Sabotage was thought to be by those who owned hand-carts, donkey-carts, etc. and engaged in bringing water to the village from a river, spring or other source. The Ministry of Health supply was considered to be a direct threat to their livelihood and these people were thought to be responsible for the pipe breakage and destruction of equipment that rendered a supply inoperative. In other communities, thieves stole the brass and copper fittings from pumps, engines and hydrams for their scrap value, putting the supply out of commission.
6. **Poor design and construction:** Some schemes had failed to deliver water due to design errors, wrong type or size of equipment and piping being installed.
7. **Revenue collection:** Schemes failed where the local people were not willing to support the projects by paying for a water supply, hence it could not function properly.
8. **Distance between schemes:** This made it difficult for a maintenance man or unit to service the schemes regularly, or for an operator to pump water regularly, as in some divisions where one operator was responsible for a group of schemes.
9. **Human factor:** It was evident from field visits that in those areas where the health officers were generally interested tended to be well operated and maintained than where the health officer was not so interested.
10. **Breakage of Hand pumps:** Some type of hand pumps such as Craelius, Oasis and Simac could not withstand hard use by the public and very expensive to repair when they broke down. Hand pumps were installed and left to run as long as possible and when one broke down; it was abandoned, or removed and never replaced, or put away for repair until the funds were available.

Ministry of Regional Development (MRD): Under this Ministry, two river basin authorities were initially established in order to undertake multi-purpose studies and projects. Under this ministry, two more authorities were later created, for the Ewaso Nyiro North and South respectively, the National Irrigation Board fell under this Ministry. Although development of drinking water supply was not a primary MRD objective according to the GoK distribution of functions, some water projects were undertaken with donor support. The most significant one was the Dutch financed

programme under the auspices of the Lake Victoria Basin Development Authority. The ministry also covered the Larger Irrigation Schemes portfolio⁸².

Ministry of Arid, Semi-arid and Wasteland: This Ministry (MOASAL) was created to support the development of the marginal areas. Water was considered one of the most limiting factors for sustainable settlements in arid and semi-arid areas. MOASAL was given priority to water development projects within its programmes. These activities were important for environmental protection and rehabilitation as the areas designated were environmentally vulnerable⁸³.

Ministry of Co-operatives and Social Services: The community development department of the Ministry of Co-operatives and Social Services was in overall control of self-help schemes in rural areas in accordance with the government policy “to extend participation in the development of the country to the mass of the people”. Self-help schemes included schools, dispensaries, markets and other facilities in addition to water supplies. The programme was in operation since Kenya gained independence and was financed by a combination of labour, materials and cash provided by the community and assistance in technical advice. Cash and materials were contributed in varying amounts by local authorities, government, international agencies or other sources⁸⁴.

The Ministry of Energy (MOE): This ministry was involved in water development and management programmes especially through its authorities, Kerio Valley Development Authority (KVDA), Lake Basin Development Authority (LBDA), and Tana and Athi River Development Authority (TARDA). In some of the major rivers water for hydro-electric power was a significant claim on the resource. Although much of the stored water was subsequently available for other uses, the flow regime was drastically changed and an evaporation loss was substantial. The necessary river works were subject to the procedures determined by the Water Act, administered by the Water Appointment Board⁸⁵.

82 Ministry of Water Development, Kenya and Swedish International Development Authority (1992). Delineation Study the Water Sector in Kenya, July 1992.

83 Ministry of Water Development, Kenya and Swedish International Development Authority (1992). Delineation Study the Water Sector in Kenya, July 1992.

84 WHO (1971). Sectoral Study and National Programming for Community and Rural Water Supply Sewerage and Water Pollution Control. Report No 1. General Community Water Supply Problems. Brazzaville.

85 Ministry of Water Development, Kenya and Swedish International Development Authority (1992). Delineation Study the Water Sector in Kenya, July 1992.

Other Facilitating Ministries: The major part of the water sector (that is, the public sector part) operated within the development planning framework, financial resources and decentralised support services provided by the Ministry of Finance/Treasury, and the Office of the President (Provincial Administration), respectively. The State Corporations and Local Authorities were to some extent independent of the central government and civil service regulations. For fully private initiatives, the above facilitating ministries, as well as the Sector ministries, were given regulatory functions only⁸⁶. Table 2.10 is a representation of main development premises of water and sanitation development in Kenya after independence⁸⁷

Table 2.10: Main development premises of water and sanitation development in Kenya after independence⁸⁸

Period	Descriptive trend	Objectives (“ideal”)	Implications (“real life”)
1960s – mid 1970s	Social services and poverty alleviation	Free basic water and sanitation services for all by the government	Unrealistic targets: coverage remained low
Mid 1970s – early 1980s	Supply-driven approach and Self-help initiatives	Self-help initiatives ensuring community participation	Many self-help schemes were taken over by the government
Early 1980s – mid 1990s	Decentralisation and commercialisation	Local authorities and NWCP get increasing responsibilities	De-concentration instead of decentralisation
Mid 1990s – Present	Towards a more decentralised and delegating policy	Community water supply. Emerging policy: delineation and clarification of roles	Declining government resources triggered policy changes
Present to Future	Policy and reform implementation. Private sector participation. Devolution of services to the County Government	Delegation, Re-regulation, IWRM, Resource mobilisation, Capacity building and Sanitation concerns.	Reform impacts still to be seen

86 Ministry of Water Development, Kenya and Swedish International Development Authority (1992). Delineation Study the Water Sector in Kenya, July 1992.

87 Nyanchaga E.N (2004). Strategic Country Report Kenya: Barriers to and Conditions for the Involvement of Private Capital and Enterprise in Water Supply and Sanitation in Latin America and Africa; Seeking Economic, Social, and Environmental Sustainability. Department of Civil Engineering University of Nairobi. Kenya.

88 Nyanchaga E.N (2004). Strategic Country Report Kenya: Barriers to and Conditions for the Involvement of Private Capital and Enterprise in Water Supply and Sanitation in Latin America and Africa; Seeking Economic, Social, and Environmental Sustainability. Department of Civil Engineering University of Nairobi. Kenya.

CHAPTER THREE

3.0 DEVELOPMENT AND MANAGEMENT OF WATER SERVICES

3.1 Sources of Water Supplies

Water supply technology over time has tended to be influenced by various reasons, which include inter alia, availability of capital, water, topography of area to be supplied, the target users and water quantity and quality requirements. Availability of capital is central to all. A few years after 1895 the colony had no infrastructure and in general developed. The demand for water forced the settlers to use unimproved water from natural sources such as well, rain water, and spring water. As time progressed, piped water took precedence and to date availability of water has become synonymous with piped water supply. Modes of water supply technologies over the years comprised of the following.

3.1.1 Water Condensing Plant

This is the oldest mechanised form of supply in Kenya. In 1895, a condensing plant was installed in Mombasa town to serve the railway construction. The plant was operated for four years¹.

¹ Whitehouse R. N (1902). To the Victoria Nyanza by the Uganda Railway. The Scottish Geographical Magazine. April 1902.

3.1.2 Rainwater Harvesting

Rainwater harvesting, whose lost glory is currently being re-visited globally, is among the earliest technologies used in the Country. Roof catchment was the chief supply of drinking water in the beginning of 1900. By 1908, the existing water supply sources in Mombasa from which the inhabitants obtained water included 55 rain water cement tanks receiving water from corrugated iron roofs².

A report on the site and buildings of Rabai Station submitted to His Excellency the Acting Governor by S. L. Hinde, Provincial Commissioner, and Milne, the Principal Medical Officer, May 18th 1909 revealed the following³:

“The Seyidie Province (Current Coast Province) is more unfortunate than most parts of the protectorate in its scarcity of potable water; there are practically no permanent streams, rivers, or springs in existence, only rain holes and pools left in dried up river beds” --- “The tank attached to the house for the storing of rain water (practically the only system in the Seyidie Province for the supply of drinking water to Europeans) appears to be in a good state of repair. The manhole traps fit closely and properly. The surface is cracked, how deep we are unable to say”.

- Shimoni station within the same province in 1913 attests to the fact that rainwater harvesting at the time was an all important source of water. The Assistant District Commissioner wrote to the Provincial Commissioner on the question of water supply on January 9th 1913 notes that:

“the Executive Engineer of the Public Works Department promised to take up the question of the supply of a number of water tanks to enable me to conserve sufficient rainwater at this station for drinking purposes for the 20 askaris, prison warders, prisoners, boat boys and office staff in all about 35 souls⁴”

In Mombasa all the houses situated in Kizingo and Pas Serani were supplied with large cement tanks for the accumulation of rainwater collected from the corrugated iron roofs most of them attached to houses occupied by Europeans and several having been built by enterprising natives for the purpose of selling water). This

2 British East Africa Protectorate (1911) Taveta Water Supply, Ref. PC/Coast/ 1/15/133, Kenya National Archives, Nairobi, Kenya.

3 Hinde, S. L. and Milne, A.D (1909). Rabai Station. Kenya National Archives, Ref. PC/Coast/ 1/12/114, Nairobi, Kenya.

4 Provincial Commissioner Seyidie (1913). Tanks for Shimoni, Kenya National Archives, PC/Coast/ 1/14/63, Nairobi, Kenya.

form of supply continued until 1916 when the Mombasa water supply was commissioned having started in 1911.

- The Executive Engineer, PWD, Mombasa on 9th September 1934 wrote to the Director of Public Works Department on Kilifi water supply identifying the existing water supplies as: A supply of blackish water pumped from a well to a storage tank on hill and gravitating from there to a number of connections in the boma; and a rainwater catchment area consisting of: A large concrete pan 87 ft. x 84 ft. drawing into 4 inter-connected concrete lined underground tanks, having a joint capacity of 11,132ft³. A small concrete pan 30ft x 20ft drawing into a concrete lined underground tank having a capacity of approximately 4,544ft³⁵.
- The Engineer went ahead to note that during the year no difficulty was experienced in the pumps system and there was a likelihood of small surplus of funds remaining at the end of the year. However, the rainwater catchment scheme had given considerable trouble, both the concrete catchment apron and the tanks needing repair. No funds had been provided for the latter's service, which was an integral part of Kilifi Boma Water System and as important or more important than the pumping scheme as it provided the whole drinking and cooking water for the Boma. The engineer sought authority to spend the surplus from the pumping scheme to make good the faults from the rainwater catchment scheme.

Before 1902, Kavirondo, which consisted of South (current Nyanza Province and Kericho district –Bomet and Buret included) and North Kavirondo (current Western Province), was in the Ugandan territory. As put by the then Commissioner (title later changed to governor in 1908), Sir Charles Eliot, that 'To cross the lake is like visiting another country'. The whole country intervening between Lake Victoria and Naivasha was actually under the Ugandan protectorate. Before any scheme of development could be launched, the area east of the lake had to be detached from its nominal incorporation in the Kabaka's Kingdom and joined up with the East Africa Protectorate. This was done in 1902⁶.

The development of water supply in this region coincided with the reaching of the Uganda Railway in Port Florence (Kisumu) in 1901. The Railway developed its supply in 1901 in Kisumu which also served the public till 1926 when a supply from Kibos River constructed by the Public Works Department was commissioned. Therefore, Kisumu experienced the first organised supply in Kavirondo area.

5 Colony and protectorate of Kenya (1929-1949). Water supplies in Kilifi District including Malindi, Kenya National Archives, ref. CA/17/89, Nairobi, Kenya.

6 Colony and protectorate of Kenya (1913-1959) Kisumu water supply, BY/35/2 Kenya National Archives, Nairobi, Kenya.

Prior to organised water supply, Kavirondo (Current Nyanza Province) obtained its water sources for the inhabitants from: Springs, Rivers, Furrows, and Rainwater (stored in tanks for drinking water especially for Europeans)⁷.

The Health Office Kisumu writing to the Assistant Engineer (Maintenance Division) Uganda Railway Kisumu on the water supply wrote ‘During a house to house inspection of water tanks attached to the houses in Kisumu, it was noticed that these were in a very unsatisfactory state.

As inhabitants generally depend on their rainwater tanks for their supply of drinking water, it is very essential that these should be looked after and kept in perfect order- it is well known that the public water supply is not suitable for drinking purposes⁸. The extracts serve to show that by 1921 Kisumu had a public water supply which was probably built in 1901 when the railway reached there. In addition, rainwater was still a complementary supply.

In 1953, a rock catchment was constructed in Tausa, Taita District. Generally, rock catchments were common from 1895 to 1950s in the region between the coast and Nairobi prompted by the climate obtainable in these areas and the physical conditions favouring the same.

By 1929, Lamu Township was relying on well water and rainwater for drinking. A petition to the Commissioner of Customs by workers of the department stationed at Lamu illustrates this. On 9th December 1929, the workers wrote the petition, which read in part,

“we are experiencing great difficulty for want of drinking water (Rainwater) at present. The staffs were getting drinking water from the prisons. It has been stopped since long time. The offices of all the departments such as Administration, Prisons, Medical, and School, had their own water tanks and used rain water to drink. The question of the people here, they use samba water and we should say that of course, it is very tasteful but not healthy and it often comes very dirty and especially it is not good to use it in rainy season. The well water is very bad and salty. The Sub Assistant Surgeon (SAS), Lamu, advises us to use rainwater to drink for the health and informs to make arrangements for the water tank as early as possible”.

From this piece of information, it can be safely taken that the supply was from rainwater, and well water. In response to the above petition, which was also copied to the Medical department, the medical officer in-charge of Lamu recommended a

7 Colony and Protectorate of Kenya (1913-1959) Kisumu Water Supply, BY/35/2 Kenya National Archives, Nairobi, Kenya.

8 Colony and Protectorate of Kenya (1913-1959) Kisumu Water Supply, BY/35/2 Kenya National Archives, Nairobi, Kenya.

tank for the customs department from a health point of view. This actually confirms that the township had not got a piped supply⁹.

In 1942, Wassin Islands within Kwale district in the Coastal region depended on rainwater. This same year the DC wrote to the PC submitted:

”that the only freshwater supplies on Wassin Island, are (a) a large communal rain water catchment basin, constructed with lime and cement and (b) One or two very small private basins of similar construction”¹⁰.

3.1.3 Ground Water Supply

Groundwater is of considerable importance in the socio-economy aspect of people’s life, more so than it might seem given that it only constitutes about 5% of the Republic’s renewable water resources; in the 2009 Census, 43% of rural and 24% of urban households stated that they relied on a spring, well or borehole as their main source of water. Its intrinsic advantages – its ubiquity, the speed with which it can be developed, the relatively low capital cost of development, its drought resilience and its ability to meet water needs “on demand” – make it a critical component in rural water supply and for small (and sometimes large) towns, as well as domestic water, irrigation, industry and commercial uses. However, despite its importance, the value of groundwater is not fully appreciated, nor is its vulnerability properly understood.

Kenya does not have policy, legislation and institutions dedicated specifically to groundwater management. Rather, groundwater management is subsumed under broader policy, legal and institutional frameworks dealing with the management of water resources, or more broadly, natural resources, and with land use and physical planning. The existing policy, legal and institutional frameworks are deficient from the perspective of groundwater management. An overhaul would be required to bring them in line with the requirements of frameworks for sound groundwater management. Deficiencies have been identified in key areas, notably over-arching and multi-sectoral policies¹¹.

9 Colony and Protectorate of Kenya (1929-57). Water Supplies in Lamu District, Kenya National Archives, Ref. No. CA/17/10/1, Nairobi, Kenya.

10 Colony and Protectorate of Kenya (1950-57). Water supplies Teita District including Taveta. Kenya National Archives, Ref: CA/17/108, Nairobi, Kenya.

11 Nyanchaga E.N and Ombongi K.S. (2007). History of Water Supply and Sanitation in Kenya, 1895-2002. Environmental History of Water, Chapter 21. IWA Publishing, Alliance House, 12 Caxton Street, London UK.2007.

3.1.4 Springs, Streams and Rivers

Naivasha: The First proposal to bring water to the Township of Naivasha was put in and acceded to by the government in 1913 and a provision to supply water to Naivasha made in 1914 estimates. The plaque outbreak caused the scheme to be shelved. Up to 1928, the people of Naivasha obtained water from rivers and streams nearby when the town public wells were sunk.

Fort Hall: By 1911, water supply for Fort Hall boma comprised of rainwater and conveyance from the river with a cart for which a rate was levied. In absence of a cart, more people were needed to do the job, and convicts and station hands were used. Convicts were also employed on carrying water, road-making, grass-cutting, cutting wood and shamba work.

Kitui: The Kitui Township was gazetted in official gazette in 1st June 1909 and by 1911, water was drawn from privately owned well and river Kalundu¹².

Mumias and Kisii: By 1911, water supply was obtained from natural springs and was satisfactory¹³.

Nyeri: By 1915, water for drinking purposes was fetched from Chania River and from rainwater collected in tanks. For other purposes there was a water furrow running through the township¹⁴.

Kericho: Before 1914, springs and streams were the main source of water in Kericho. During the dry seasons, the convicts and porters fetched the government officials' water from adjoining streams in Kericho town by 1920¹⁵.

Simba Springs in Maasai District in Ngong: The Maasai Kept vast herds of cattle and during the dry period of the year the Simba springs came in handy for watering the herds. In 1948 the springs had been well protected and constructed to enable efficient and healthy watering of the herds. The 1948 drought was so severe for the

12 District Commissioner, Kitui (1911). Annual Report 1911. Kenya National Archives, DC/KTI/1/1, 1911.

13 District Commissioner (1911). Report by the Provincial Commissioner for the Twelve Months Ending March 31st 1911. Kenya National Archives, PC/NZA/1/1/6, Ref: 587/18/1. 8th April 1911.

14 District Commissioner, Nyeri (1915). Annual Report–Nyeri District for the Year Ending 31st March 1915. Kenya National Archives, DC/NYI/1/2, Ref: 125/6/15. 10th April 1915.

15 Colony and protectorate of Kenya (1920-1923)., Kericho district Annual Report, Dc/Ker/1/1, Kenya National Archives, Nairobi Kenya.

large herds that the springs could not cope with the demand and more boreholes were sought¹⁶.

3.1.5 Pans and Dams

Construction of dams and pans involves impounding the surface supplies. According to water development division, dam construction work was primarily a water augmentation exercise. Due to scarcity of water for irrigation, watering the stock or for general human consumption, dams were constructed to curb the water shortage problem particularly during the dry season. The water development division advised on the dam construction sites. It was a significant exercise particularly in water scarce areas of Northern frontier region. Before 1950, dam construction was an individual or community affair usually under the guidance of the provincial administration. The Public Works Department and the Ministry of Agriculture's Dam Construction Unit became very active in 1950s.

Kericho: Construction of water dams and pans was in Kenya first recorded in 1914. In 1914, an Indian, V. Anandji, constructed the first water dam and its mill on Riondoseik River. Other Indians followed suit and constructed six more dams between the years 1916 and 1920¹⁷.

Kwale: In Kwale, Mwavumbo and Kikomani dams, constructed in 1927 are the oldest recorded dams.

Machakos District: In 1929 considerable progress was made in dam construction in Machakos District. Three dams were built at Kiasu, one at Masii and another in upper Mbooni. Two at Kilungu and one at Kalome and one in lower Mbooni were enlarged. By this time the natives had recognised the usefulness of a dam and thus the former opposition was withdrawn. Although rain destroyed the dams, repairs were accordingly done. By the end of 1928, 43 water connections had been made. During December, fencing of the catchments area commenced to prevent any contamination of water¹⁸. In 1930 eight dams were constructed in Machakos

16 Colony and protectorate of Kenya (1938-1948). Water supplies, Simba springs. Kenya national Archives, Ref: RP/21/19, Nairobi Kenya.

17 Colony and Protectorate of Kenya (1920-1923). Kericho District Annual Report, Dc/Ker/1/1, Kenya National Archives, Nairobi Kenya.

18 Senior Commissioner, (1929). Ukamba Province, Annual Report 1929. Kenya National Archives, PC/CP/4/2/3. 1929.

reserve and several others were repaired or added to bringing to total of 30 dams. The district commissioner reported that the natives by this time appreciated their usefulness and made applications themselves for construction¹⁹.

Northern Frontier District: In the Northern frontier region, pans and dams were the most widely carried out water development work. It was usually done both before and after the short rains and depending on the locality of rainfall. It was cheap, needed no expertise, and was easy to dig. Pans and dams required constant cleaning and deepening to improve the retention level and reduce pollution. Before 1920, water supplies were limited to collection from various surface rivers, springs and sparsely distributed water holes. The inhabitants also excavated water from the sandy beds after heavy rains²⁰. The DC coordinated the manual work done by the paid gang or communal labour.

In Moyale, pans and dams were usually dug in large numbers for maximum conservation. The most significant pan in Moyale was the Alati pan, which belonged to Ajuran and Degodia tribes. During good rains Alati pan was usually full and supplied adequate water to the two tribes. Various tribes were allocated different roles in pan improvement. Pan digging was purely a communal affair²¹

In 1945 a number of water pans were dug in all districts in the province. Camels pulling plough and scoops proved a satisfactory method, though the task needed a bulldozer. There were large pans dug at Banissa and Hidan Golja in the Mandera District. At Wajir concrete tops were built for four wells for the Degodia and four for the Ogaden. The Dela pan was well dug by the Degodia and held plenty of water at the end of the year²².

In 1946 the Development Committee had approved, the expenditure of 485,700 pounds over a period of ten years on the provision of water supplies in the Northern Frontier District, Samburu and Turkana as it was recommended by Dr Dixey. In all the districts in the NFD gangs of tribesmen were employed under the supervision of the District Commissioners to excavate pans and tanks in areas far away from the permanent water supplies. Sites were chosen where rain water used to collect in a slight declivity in the ground and tanks were dug as deep as possible. The average evaporation rate of water was three metre a year. Work was being done by local tribe

19 Provincial Commissioner, (1930). Ukamba Province, Annual Report 1930. Kenya National Archives, PC/CP/4/2/3. 1930.

20 Thomson C.B (1917). Reference No 11/120 of 4/5/17. Kenya National Archives, PC/Coast/1/15/71, Ref: 143/39/17. 12th May 1917.

21 DC, Moyale (1945). Digging Water Pans/Improvement to Wells. Kenya National Archives, BB.7/29, Ref: PW/8/4/102. June 1945.

22 Provincial Commissioner, (1945). Annual Report Northern Frontier District, 1945. Kenya National Archives. PC/NFD/1/1/8, 1945.

labourers and they were paid at the normal rates, while the headmen supervised the work and provided camels for carting water and meat for the men²³.

In 1946 a total of twenty tanks and earth dams were excavated, nine cement well tops were constructed in the Wajir District, and three rock pools successfully dammed up with concrete walls in Mandera. In addition, three boreholes were completed with plant acquired from the army in Isiolo²⁴.

The Wajir 3-year development schemes continued under the District Development Officer and later under the supervision of District Commissioner. In 1947 two new pans were made on the Ali Gollo track about 19 and 27 kilometres North of Tarbaj, an old pan at Sunkela deepened and the dam at Singu repaired and deepened.

However, on Dr. Classen's advice the construction of pans was discontinued in favour of deeper tanks due to effects of high evaporation loss. For example, at Wajir in the dry season, the evaporation loss was almost one foot a month. In order to facilitate future planning tests were made to find out the water consumption figures of various livestock and useful data was obtained²⁵.

Public Works and Dam Construction Units: The construction of dams was mainly carried by two separate departments, firstly, the dams constructed by the public works as a means of augmenting water supplies to mainly townships and a good example are the Ruiru and Machakos dams, secondly, the dams constructed by the Dam Construction Unit (DCU) working under the Soil and Water Conservation Service Unit (SCSU) of the Ministry of Agriculture, Animal Husbandry and Natural Resource²⁶.

The dams constructed under the DCU were mainly aimed at both controlling flood water as well as conserving the water for agricultural purposes especially in the semi-arid areas. Most of the dams were constructed in mainly European held areas as most of the European farms required a whole dam for the water requirements of one farm.

The total number of hydraulic schemes accomplished by 1953 was 706 dams, 90 waterholes and 12 other works that included rams, drainage, minor irrigation etc. Thus the total number of hydraulic structures of various kinds dealt with by

23 Provincial Commissioner, (1946). Annual Report Northern Frontier District, 1946. Kenya National Archives. PC/NFD/1/1/8, 1946.

24 Provincial Commissioner (1946). Annual Report Northern Frontier District, 1946. Kenya National Archives. PC/NFD/1/1/8, 1946.

25 District Commissioner (1951). Wajir District Annual Report for the Year 1951. Kenya National Archives. DC/WAJ/1/1/3, 1951.

26 Soil conservation Engineer (1953). Annual Report 1953: Soil Conservation Engineer's Section and its Dam Construction Units and Contracts. Kenya National Archives, RP/14/9. 1953.

the SCSU, including dams and waterholes built by the dam units was 808²⁷. The dam construction activities went at a feverish pace within the 1950's and a lot was accomplished in the period 1950 - 1953²⁸.

In 1954, a notice was placed by the Hydraulic Engineer for general information with an objective of encouraging the development of water resources of the colony, for agricultural purposes of all kinds by construction storage dams. The Government approved the terms and conditions set out in the notice for the purpose of governing the grant of subsidies for dam construction, which was to take effect as from 1st January 1955, with the following conditions applying²⁹:

- African farmer meant any member of the African races indigenous to the colony engaged in farming an agricultural holding of not less than eight acres.
- Agricultural officer meant any District Agricultural officer of the Agricultural department. While Approved meant approved by the hydraulic engineer.
- Assessed cost meant the total cost of construction of the dam as estimated by the Hydraulic Engineer. The estimate was to be based on the experience of the Government Dam Construction Units and the Government works generally. It should also include the cost of site preparation and foundations, provision of control sluices and spillway and other necessary ancillary works, but no provision of any pumping apparatus should be made.
- Colony Meant the Colony and Protectorate of Kenya. Co-operative society meant a body corporate registered under the Co-operative Society's Ordinance whose members collectively farm not less than 20 acres of agricultural land.
- Dam meant a structure built across a depression, or a tank excavated at ground level, for impounding and storing surface water, and included the ancillary works needed to dispose of flood water, and the conduits and controls necessary for the release of water.
- Dam construction unit meant a mechanical dam construction unit financed from public funds.

27 Ministry of Agriculture Animal Husbandry and Natural Resources (1953). Soil Conservation Section and its Dam Construction Units and Contracts, Annual Report. Kenya National Archives, Ref: RP/14/9, Nairobi Kenya.

28 Ministry of Agriculture Animal Husbandry and Natural Resources (1953). Soil Conservation Section and its Dam Construction Units and Contracts, Annual Report. Kenya National Archives, Ref: RP/14/9, Nairobi Kenya.

29 Hydraulic Engineer (1954). Conditions Governing the Granting of Subsidies for the Construction of Storage Dams. Kenya National Archives. AK/24/3, 1st December, 1954.

Each application for subsidy was to be in respect of one dam only and be accompanied by a non-refundable fee of shilling 100 to cover, in part, the cost of the technical examination of the application. No subsidy was payable in the following cases³⁰:

- Where no water permit or sanction had been granted for the construction of the dam.
- Where it was found that construction of a dam had commenced prior to the approval of the application for subsidy.
- Where the construction of dam was to be financed in whole or in part by direct grant from central government or east African high commission funds.
- Where the total assessed cost of the dam does not exceed 160 pounds in low rainfall areas, or 200 pounds in high rainfall areas.
- Where an applicant had not discharged his liabilities to government in respect of work carried out previously on his behalf by a government dam construction unit.
- Before any application for subsidy, was approved the Hydraulic Engineer had to satisfy himself that³¹:
- An Agricultural Officer had certified that the dam was necessary for the full economic development of the agricultural holding to which the application related, having regard to the existing water resources of that holding.
- The catchments area and runoff were adequate to fill the dam regularly.
- The design of dam was sound and was adequate.
- The provision of Water Ordinance (1951) and all the Rules there under had been complied with.
- When approving an application for subsidy the Hydraulic Engineer should inform the applicant of the amount of the subsidy to be paid and the assessed cost on which it was based.

The approval of a subsidy should be valid for a period of one year. However, an extension of the period of validity of the approval would normally be granted if works were still in progress, provided that they would proceed continuously to completion. If works had not commenced within the year of validity, a new application would have to be made³².

30 Hydraulic Engineer (1954). Conditions Governing the Granting of Subsidies for the Construction of Storage Dams. Kenya National Archives. AK/24/3, 1st December, 1954.

31 Hydraulic Engineer (1954). Conditions Governing the Granting of Subsidies for the Construction of Storage Dams. Kenya National Archives. AK/24/3, 1st December, 1954.

32 Hydraulic Engineer (1954). Conditions Governing the Granting of Subsidies for the Construction of Storage Dams. Kenya National Archives. AK/24/3, 1st December, 1954.

The Hydraulic Engineer could order construction of certain additional work which in his opinion was necessary for the proper security of the dam before payment of subsidy. The payment of subsidy would then be made only after such work had been completed to the satisfaction of the Hydraulic Engineer, who had the right to inspect the site at any time before, during and after construction in order to check the dimensions, workmanship or any other matter relating to the construction of the dam³³.

The subsidy to be paid on a completed dam was 40% of the assessed cost of the dam in low rainfall zones where probable annual rainfall was less than 30” or 25% of the assessed cost of the dam in high rainfall zones where the probable annual rainfall was 30” or above. The adjustment were done in such a manner that the assessed cost of the dam exclusive of the subsidy could be below 160 pounds in the case of low rainfall areas, or 200 pounds in the case of high rainfall areas. The subsidy was subject to the following maxima: 1,600 pounds in low rainfall zones and 1,000 pounds in high rainfall zones. These maxima could be exceeded in special cases at the discretion of the Minister for Agricultural³⁴.

If during the course of the works, increased costs or unforeseen difficulties occurred, the subsidy payable could be increased at the sole discretion of the Hydraulic Engineer. The Hydraulic Engineer could as a condition of payment of a subsidy require the applicant to permit the installation of a staff gauge and rain gauge at the dam and take readings of rainfall and water levels at such intervals and over such a period as might be directed to him. The gauges were to be supplied and installed by the Hydraulic Engineer free of charge and thus they were to remain the property of the Government. Where a Government Dam Construction Unit was used for the construction of a dam, the subsidy if any, payable were to be deducted from the account submitted in respect of Government Dam Construction Unit charges³⁵.

In the event of the recipient of a subsidy assigning, transferring, sub-leasing or otherwise alienating the land for whose benefit the dam was constructed within a period of five years after the payment of such subsidy, he was to refund payment of subsidy to Government. This provision was supposed to be embodied in a document which was registered against the title, if any, of the property was in question.

No liability whatever was attached to the Government or to any servant of the Government for any damage or loss of whatsoever nature arising out of any

33 Hydraulic Engineer (1954). Conditions Governing the Granting of Subsidies for the Construction of Storage Dams. Kenya National Archives. AK/24/3, 1st December, 1954.

34 Hydraulic Engineer (1954). Conditions Governing the Granting of Subsidies for the Construction of Storage Dams. Kenya National Archives. AK/24/3, 1st December, 1954.

35 Hydraulic Engineer (1954). Conditions Governing the Granting of Subsidies for the Construction of Storage Dams. Kenya National Archives. AK/24/3, 1st December, 1954.

way attributable to the design or construction of any dam in respect of which an application for subsidy had been made, and the application for or the recipient of any subsidy was supposed to at all times keep Government and any servant of Government effectually indemnified against all actions, claims, losses and expenses whatsoever arising out of or in any way attributable to anything done or omitted to be done by Government or any servant of Government in connection with the design or construction of any such dam³⁶.

Government Dam Construction Policy: In 1956, the Secretary for Agriculture suggested that for the development of a sound agricultural economy in Kenya, on which the future prosperity of the whole Colony depended, it was essential that all possible steps should be taken towards the conservation and development of water supplies so as to ensure that adequate water was available as soon as possible in all farming areas, both European and African, and especially those where intensive mixed farming was practiced³⁷.

In 1949 due to the limited number of contractor's firms which were offering dam construction services at a cost within the reach of the farmers, or on an adequate scale, the Government introduced a dam construction services. The services were to be provided by two Heavy Dam Construction Units (a third was added in 1953). The units were operated by the Department of Agriculture, to construct dams throughout the Africans and European areas. The charges were levied on the basis of the bare cost of operation inclusive of an element for the depreciation of equipment. It was further reported that over the past seven years there was a number of cases that the units had suffered loss either due to bad debts written off or because of other factors such as climatic or soil conditions, making the final cost of a dam to exceed the estimate given to the farmer from whom, in his equity, it had not been possible to recover such excess³⁸.

There was no appreciable improvement which had been done in respect to the provision of a dam construction service by private contractors. This included an agreed minimum programme of work concentrated in one area, and the contractors could abandon their dam making activities if a more profitable work became available in their fields. The cost to the farmer under private enterprise definitely was higher³⁹.

36 Hydraulic Engineer, (1954). Conditions Governing the Granting of Subsidies for the Construction of Storage Dams. Kenya National Archives. AK/24/3, 1st December, 1954.

37 Secretary for Agriculture, (1956). Government Dam Constructed Policy. Kenya National Archives. AK/24/3, Ref WAT.9/2/24/1/199, 18th February, 1956.

38 Secretary for Agriculture, (1956). Government Dam Constructed Policy. Kenya National Archives. AK/24/3, Ref WAT.9/2/24/1/199, 18th February, 1956.

39 Secretary for Agriculture, (1956). Government Dam Constructed Policy. Kenya National Archives. AK/24/3, Ref WAT.9/2/24/1/199, 18th February, 1956.

Work organisation: The dam construction units organized their work in terms of work programme per catchment area or just regions. The catchment area or region so selected under a certain program would then be divided into sub-areas for example dam construction programme No. 4 1953 involved the Rift Valley Catchment area, under which Ol-kalou, Kinangop, Naivasha, Nakuru and Molo were sub-areas. Each D.C.U was allocated a certain catchment area in which to operate and could then be transferred to another area after completion of the work, e.g. DCU No 2 was allocated to programme No 4 after it had finished its work in Uaso Nyiro catchment area; it then proceeded to Western province after completion of its work programme No 4.

The farmers or others willing to have a dam constructed say on their farm or area would make an application straight to the SCSU where such applications would be looked into and if feasible the design would proceed. A high percentage of the applications would be cancelled for various reasons including cost, feasibility etc., a good example is the Rift Valley catchment area where 87 applications were received and 27 dams were built under programme No 4.

The dam construction units worked as a contracted company to design and built the dams. The farmers or other persons paid for the service. As indicated in the annual report of 1953, the DCU's of the Ministry of Agriculture Animal Husbandry and Natural Resources were not the only Dam construction units in operation at the time. District Soil Conservation Service at Nakuru, Eldoret, Thompson's falls and Ruiru had their own Dam construction units and involved themselves with dam construction activities⁴⁰.

The Minister for Agricultural therefore directed that, in the interests of continuity and cheapness of service, and coordination with agricultural planning, the Government Dam Construction Units would continue to offer dam construction services to both Europeans and African farmers in all parts of the Colony. The Minister for Agricultural further directed that⁴¹:

- Charges should not be raised to that level charged by private contractors as the intention was not to meet the profit factor inherent in private enterprise.
- An element should be included to provide a small reserve to meet contingencies such as bad debts, interest on capital, ex gratia repayments, but excluding net profit.
- charges should cover all costs of operation and should not contain an element of hidden subsidy as alternative provision was already made for dam subsidies

40 Annual report (1953), Soil Conservation Section and its Dam Construction Units and Contracts, Ref: RP/14/9, Kenya national archives.

41 Secretary for Agriculture (1956). Government Dam Constructed Policy. Kenya National Archives. AK/24/3, Ref WAT.9/2/24/1/199, 18th February, 1956.

whether constructed by DCUs or not, under Vote D' 6 Head three Rural Water Supplies, Item 9-Dam Making Subsidies.

3.2 Water Conveyance Systems

3.2.1 Furrows

Furrows were important in reducing the distance between the water source and the people. They were dug to convey water to the townships, boma or homes. This mode of conveyance was common and is still applicable to date particularly in areas without water supply but with water bodies and appropriate gradient.

Taveta: Church missionary society had a furrow conveying water through Taveta Station. The administration planned to use station hands to dig another furrow for Rs 300 and labour from station hands. It was supposed to be six kilometres long⁴².

Fort Hall (Murang'a): In 1915 a water furrow 7 to 13 kilometers in length receiving its water from the Karichungu River was completed in Fort Hall the current Murang'a town, passing the officers houses, police station, post office, clerk's houses, police lines, warders and retainers lines, and the bazaar, it emptied itself into the Muara River. Ref.

Fort Hall in 1915 employed convicts on carrying water, road-making, grass-cutting, cutting wood and shamba work⁴³.

However, most furrows were used as irrigation canals. In 1965/66 the Ministry of Natural resources water development department put up the following irrigation furrows⁴⁴:

Chain irrigation (Machakos District): The aqueduct on the Chain Furrow was destroyed for the fourth time in five years by the irresponsible actions of some of the local people. The irrigators agreed to finance the construction of a new structure designed by the department and carried out by the department and the local community.

42 British East Africa Protectorate (1914). Taveta Township. Kenya National Archives, Ref. PC/Coast/1/12/157, Nairobi, Kenya.

43 British East Africa Protectorate (1914). Taveta Township. Kenya National Archives, Ref. PC/Coast/1/12/157, Nairobi, Kenya.

44 Barret, R (1967). Annual Report 1965/66, Water development department, Ministry of Natural Resources, Republic of Kenya.

Magadi area-Nguruman (Kajiado District): The gabion weir, necessary for diverting water into the new irrigation furrow was constructed by the department for the agriculture ministry.

3.2.2 Water Carriers

Both animals and human beings were used to convey water from a point of collection to the area of need. To date, in the arid and semi-arid areas of Kenya, animals, especially camels are extensively used as a means of water transport. In towns and in moderately developed parts of the cities, donkey cart or human cart is used to transport water. Figure 3.3 is an illustration of protected spring.



Figure 3.3: A protected spring widely used as the first stage in the improvement of rural water supplies. The concrete work prevented surface pollution of the source. However, users still covered long distances to collect water⁴⁵.

In 1906, Mwatate station in Taveta was using water carriers as means of water supply to the station. A letter addressed to the collector of taxes at Mwatate from Mombasa on 23rd February 1906 on water supply reads as follows:

⁴⁵ Republic of Kenya (2008). Bulk Water Supply System: Feasibility Studies, Identification of Institutional Support. Ministry of Water and Irrigation on behalf of Coast Water Services Board by BBL ingeniens consultants with Gibb Africa ltd.

‘with reference to your letter No. 11 of the 10th instant, you may expend up to fifteen rupees per month for water carriers at Taveta. You should make adequate provision for this service when submitting your next estimates⁴⁶.

By 1914, the same form was in place.

Kericho: in 1920, all the government houses in the township had been fitted with water tanks. The water was used mostly for drinking purposes. During the dry seasons, the convicts and porters fetched the government official’s water from adjoining streams. There were two streams on either side of the station, thus the supply was sufficient⁴⁷. The water supply installation by 1932 in the township was a great boon to those constructing the bazaar as it obviated the need for carting water from the rivers. The proposed installation of a storage tank at the end of the 1932 was a boon as it could provide a constant supply and allowed sediments to settle down⁴⁸.

Mandera: Mandera Township is approximately three kilometres from the River Daua and 30.5 metres above the level of permanent water in the riverbed. In 1947, thirty donkeys supplied the Water was drawn from the holes in the sand bed when the river was not flowing. Each plot lived an average of six people who used about 2 m³ of water per day. Each donkey carried 18 litres of water for two to three times a day. Most townspeople went to the river to wash their clothes⁴⁹.

By 1955 in Turkana district, water was still drawn from shallow wells and distributed by animal transport⁵⁰.

A letter from the District Commissioner’s office Kericho of 18th November 1936 to the PC in Kisumu on Kericho water supply noted that the sum of KES 388.10 remaining in the conservancy vote was required for the purchase of oxen to replace three that had died during the year and three, which were too decrepit for work. Since the replacement of these animals was an urgent requirement the author (DO) hoped that the PC would agree to the water supply charges being met otherwise⁵¹.

46 Colony and Protectorate of Kenya (1906). Outward Mwatate. Kenya National Archives, Ref: PC/Coast/1/12/38, Nairobi, Kenya.

47 Colony and protectorate of Kenya (1920-1923). Kericho district Annual Report, Dc/Ker/1/1, Kenya National Archives, Nairobi Kenya

48 Health Officer (1932). Annual Report, 1932: Native civil Hospital-Kericho. Kenya National Archives, PC/NZA/2/14/16.

49 DC, Mandera (1947). Mandera Water Supply. Kenya National Archives, Ref: PC/GRSSA/2/20/22, and PW.8/4, Nairobi, Kenya.

50 District Commissioner, Turkana (1957). Water Supply, Kenya National Archives, DC/LDW.2/24/10, Ref: 8/3/2, 1957.

51 Colony and protectorate of Kenya (1931-1945). Kericho water supply. Kenya National Archives, Ref. PC/NZA/2/16/10, Nairobi, Kenya.

3.2.3 Pumping System

Hydraulic Rams: Hydrams formed the earliest form of pumping of surface water whenever the physical conditions allowed. They were manufactured by two companies namely Gailey and Roberts and Blake and Company. Even though wasteful as to the amount of water lost, they were dominant all through the colonial days. A case of one installed in western Kenya in 1987 remains isolated as this technology is facing extinction in the country⁵².

In June 1938, DC Kwale wrote to the PC Mombasa on Kwale water supply that:

- The Director of public works replies that Hydraulic rams would not be suitable. Messrs. Blake and Co. was not written to apparently⁵³.
- West Mvuria Grazing scheme Embu district in 1966. The installation of a ram and pipeline together with the construction of a 45.5 m³ storage tank and 9.14 metre cattle troughs were completed at a cost of 1500 pounds for the range management division. Funds for the scheme were made available by the County Council⁵⁴.
- Ingotse hydram piped scheme was a community-based project. The project started in 1987, but due to the breakdown of the hydram, the project became dormant because the ram could not be repaired. The community/ consumers thereafter approached the Kenya-Finland Western Water Supply Programme to assist them with any necessary technical and financial materials. As a result, the programme (KFWWSP) took the feasibility studies for the area in question to establish the possibilities of water supply in the area⁵⁵.
- Kericho Water Supply which was in place by 1931 utilised a ram. A letter dated 28th January 1931 from the District Commissioner's office to the department based in Kisumu acknowledged the following⁵⁶: The District Commissioner also confessed to have understood that the ram was capable of providing 32 m³ per day. This in view of the Hospital and other requirements would seem barely sufficient to ensure a constant supply to all users, unless a storage tank could be provided, a storage tank was provided. He continued to note that he understood

52 Barret, R (1967). Annual report 1965/66, Water Development Department, Ministry of Natural Resources, Republic of Kenya.

53 Colony and Protectorate of Kenya (1928-50) Water Supplies Kwale and Digo district Ref. No. CA/17/95, Kenya National Archives, Nairobi, Kenya.

54 Barret, R (1967). Annual report 1965/66, Water development department, Ministry of Natural Resources, Republic of Kenya.

55 Omino, M. O (1992). Ingotse Hydram Design Report, Kenya-Finland Western Water Supply Programme, Ministry of Water Development, Kenya.

56 Colony and Protectorate of Kenya (1931-1945). Kericho water supply. Kenya National Archives Ref. PC/NZA/2/16/10, Nairobi, Kenya.

that the Hydraulics Engineer hoped to be able to obtain a tank, which was in the country by then.

- When the supply for ram delayed Gailey and Roberts wrote to the Divisional Engineer Coast division on supply of ram type A for Wundanyi water supply in 1955⁵⁷, the following conversation took place:

“We acknowledge receipt of your letter of April 30th for which we thank you, and we hasten to inform you that the Hydram was railed to you from Nairobi on May 4th. We do apologize for the delay and for any inconvenience this may have caused your Department, but it would appear our Nairobi Head office found the obtaining of a Hydram rather more complicated than had been anticipated as this was eventually secured from an isolated branch”.

Figures available show the cost of an alternative scheme i.e. a diesel engine driving a pump to supply water from the Golini River. The intake would be 3353 metres from the storage tank. The main delivery would pass close to an excellent site for the St. Georges School. The vertical distance from the intake to the storage tank is approximately, 85.5 cubic metres⁵⁸.

Medical Officer Health Taita wrote to the PC Mombasa On 1stMarch, 1955 concerning Wundanyi water supply that:

- ‘At present, there is an interim scheme whereby water is raised by a ram to a small reservoir on the highest point of the boma. This supply is already inadequate. However, a second ram has been ordered but has not yet been installed’.

The following recommendations were made:

- a. Realigning and lining of the existing furrow to increase the amount of water available. building a small weir across the river to increase the flow in the furrow was recommended.

57 Colony and Protectorate of Kenya (1950-57). Water Supply Teita District including Taveta. Kenya National Archives, Ref: CA/17/108, Nairobi, Kenya.

58 Colony and Protectorate of Kenya (1928-1950). Water supply in Kwale and Digo District, Kenya National Archives, Ref: CA/17/95, Nairobi, Kenya.

- b. Some form of power pumping should be installed to utilize the water available. This was because, about 455 litres of water passed through the ram to lift 4.5 litres to the reservoir⁵⁹.

The progress report of Lamu water supply works dated 4th January 1956 showed the following:

- the pumping/generator house and the water sump tank next to it had been constructed and were to be equipped with pumps and pipe work in the month of February; and
- Approximately 25% of the 6-inch diameter rising main from pump house to town reservoir had been laid, its total finished length being about three kilometres.

3.2.4 Kiosk System

It was normally the Water Authority's responsibility to provide kiosks for the sale of water to the public. The public works department found that water kiosks rarely paid their way since it was necessary to have a kiosk attendant on duty all day to sell the water and money collected was not enough to pay the wages. The public works therefore appointed licensed water retailers in some of the townships instead of providing water kiosk. In return for the easy money earned, the retailer signed an agreement that stipulated the hours he was to be available for the sale of water and certain standards of cleanliness at the water supply⁶⁰.

3.3 Water Supplies Projects

The Uganda Railway as it turns out, was the first institution to construct and manage water supplies in Kenya. The construction of the Uganda Railway needed ample water supplies to run the steam engines used in trains as well as for operations at the various stations through which the Uganda Railway passed. Most water supplies to Uganda Railway stations between Mombasa and Nairobi were developed quite early with most water towers put in as early as 1898. Construction of water supplies experienced many challenges and as such innovation came in handy. An illustra-

59 Colony and Protectorate of Kenya (1950-57). Water supplies Teita District including Taveta. Kenya National Archives, Ref: CA/17/108, Nairobi, Kenya.

60 Divisional Engineer, Rift Valley, Division (1954). Sanitary Services in Townships. Kenya National Archives, PC/NKU/2/26/11. 22nd June 1954.

tion of how, for example, flash floods that swept away water works was mitigated is shown in figure 3.4.



Figure 3.4: A pipe bridge constructed to withstand floods⁶¹

The water supplies to major towns i.e. Mombasa, Nairobi, Nakuru, Kisumu, Eldoret and Kitale were first developed and managed by the Uganda Railway. In Nairobi for example the initial water supply was developed from the Kikuyu springs in 1902 by the Uganda Railways, it was later to be sold to the Nairobi Municipal Corporation in 1922. In 1901, the Uganda Railway put in a dam on the Njoro River in Nakuru to supply water to Nakuru station and when the PWD developed water supply from the Mereroni River in 1913/15 the Uganda Railway was there to manage it for the PWD. As the Uganda Railway grew stronger and expanded its operations to Eldoret in 1924, the need for water became inevitable and hence the Uganda Railway developed a water supply to the station and the town in 1928 from the Sosiani River.

Almost 70% of all the Uganda Railway water supplies were developed in the first 20 years of its operations. The mode of delivery included gravitation or pumping by engine or hydram. The sources varied from springs, boreholes and rivers. At the

61 Hunn G (1983). Progress Report About water Projects included in the Minor Urban Water Supply Programme. NORAD –Coordinator/MOWD. Nairobi Ref: WD/1/2/5. 10th June 1983.

time the Uganda Railway was not concerned with full treatment of the water and hence the water was supplied raw. As the Public works department developed new township water supplies, some Uganda Railway water supplies were abandoned as the Uganda Railway connected to the new supplies. Although the Uganda Railway developed most of its water supplies early in the nineteenth century, this did not deter it from extending its distribution system over the years and as late as the eighties the Uganda Railway was still providing water to both its employees and the public. The railway also participated in the development of major pipelines like Nol-Turesh Pipeline in 1956, the Ngong - Magadi Pipeline in 1924 as well as the Mzima springs pipeline to Mombasa in 1956.

3.3.1 Major Urban Water Supplies

Urban water development followed the building of the Uganda Railways as major towns developed along the railways mostly as railway stations. As the population in these towns increased water supplies were augmented and new ones developed. These stations became towns, then townships and later on some became cities. This subchapter will look into Nairobi, Mombasa, Kisumu, Nakuru, Eldoret, and Nyeri urban centres.

Nairobi Water Supplies

At the end of the 19th century the construction of a railway line to Link Mombasa and Uganda started and in 1899 the line reached what is now called Nairobi City. That time, it was a small railway depot. The first camps were established on the areas now known as Kiambu in order to be near the water supply sources. Figure 3.5 illustrated Nairobi city main Rivers⁶².

The earliest water supply for the railway encampment was taken from a small concrete dam within the Chiromo Estate, the present Riverside Drive, and was piped by gravitation towards the railway land. As the township expanded and population increased (figure 3.6) this supply became inadequate and to some extent fouled, a draw off point was placed further upstream within the French Mission Station. Dr. Boedecker, as the town's medical officer, recorded that this water, during the rainy season was 'simply the colour of pea-soup and undrinkable at the stand pipe.' Eventually this source of supply with its two dams was abandoned except that for

62 Tibaijuka A (2007): Cities can Achieve More Sustainable Land Use if Municipalities Combine Urban Planning and Development with Environmental Management Executive Director UN-HABITAT Director General UNON.

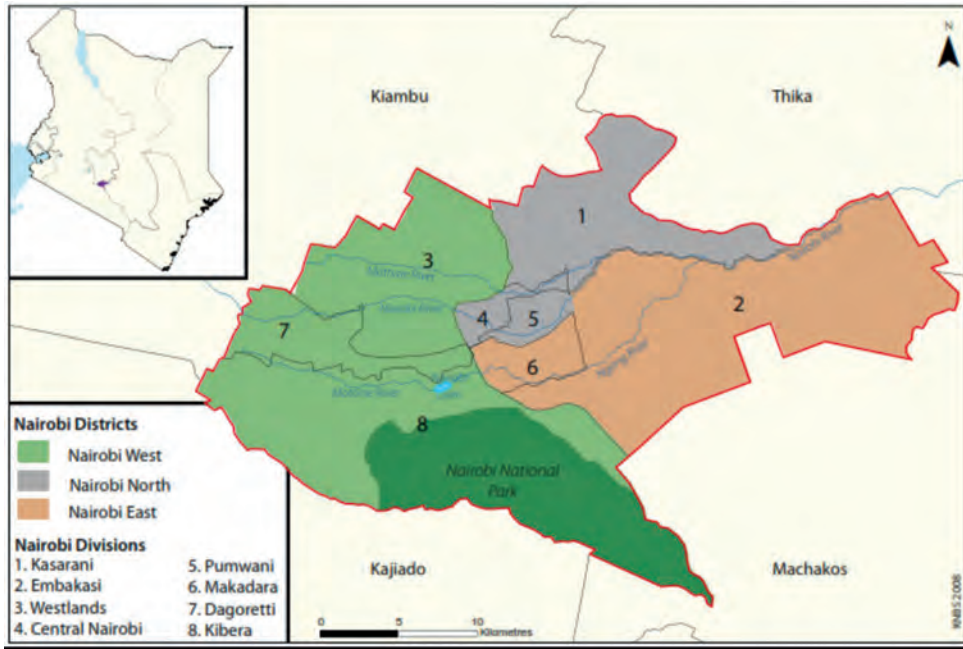

Figure 3.5: Nairobi city showing main Rivers

many years it was known as the ‘Impure water supply’ and useful for flushing out the concrete drains which were later built in Government Road and the bazaar⁶³. Table 3.1 summarizes the water supplies for Nairobi by the year 2005

Table 3.1: Summary of Nairobi water supplies by 2005

Supply	When established	Total output (m ³ /day)
Kikuyu springs	1906	273
Ruiru dam	1938	909
Nairobi Dam	1946	1137
Chania/Sasumua	1952	4546
Chania /Negthu	1974	440,000

The Nairobi Irrigation Trench: The Nairobi irrigation trench/canal was in existence as early as 1918, albeit the actual date of its installation is not known. At the time the canal was diverting water from the Nairobi River for irrigation purposes. The water from the Nairobi River was already contaminated with night soil and other

63 James S (1950). A Jubilee History of Nairobi. Kenya National Archives. CUP: 307 .76SMA. 1950.

liquid as well as solid matter released indiscriminately into the river. The canals themselves were also being fouled in a similar fashion⁶⁴.

In spite of the indiscriminate pollution the lessee by terms of his concessions, was compelled to supply to the inhabitants of the neighbourhood for “human consumption” a certain volume of the diverted water. As result of the public danger arising thereof, the administration sought to defuse the eminent public health risk. The situation led to the formation and enactment of The Nairobi River and Streams (Pollution and diversion prevention) rules of 1918 under the umbrella of the East African Townships Ordinance, 1903⁶⁵.

The rules provided for the prevention, in specific terms, of the pollution of Nairobi River, the streams and irrigation channels with any substance whether liquid or solid. The rule provided for a charge of 200 rupees for a person convicted of such an offence and a further 30 rupees for every day during which the offence is continued after conviction. The rules also prevented excess diversion from the streams or the Nairobi, over and above that authorized by the permit. The penalties for this offence were made similar those already stated above⁶⁶.

The Muthaiga water company: The Muthaiga Water Company/The Upper Nairobi Township and Estate Company limited/contractors as they were referred to in the agreement, was promulgated by the residents of the Muthaiga and upper Nairobi Township estate. Their major aim was to get water for the residents of the two afore said estates. First they considered that the government of the East African protectorate then governed by Henry Conway Belfield would agree to grant them a permit to abstract water from the Ruaraka River. Their request which was made in 1911/12 was denied and instead they were offered a different proposition⁶⁷.

The proposition involving drawing water from the pipeline from Kikuyu springs which had been put in 1906. A 4” main from the supply from Kikuyu was to deliver water to two tanks of 227 m³ each, one of which would supply Parklands area while the other would supply the area designated by the company. A maximum of 273 m³ was offered. It was estimated that each household would use 455 litres per day which meant that the supply would be sufficient for 500 households⁶⁸.

64 Colony and protectorate of Kenya (1918). Nairobi Irrigation Trench. Kenya National Archives, Ref: AG/43/117, Nairobi, Kenya.

65 Colony and protectorate of Kenya (1918). Nairobi Irrigation Trench. Kenya National Archives, Ref: AG/43/117, Nairobi, Kenya.

66 Colony and protectorate of Kenya (1918). Nairobi Irrigation Trench. Kenya National Archives, Ref: AG/43/117, Nairobi, Kenya.

67 Colony and Protectorate of Kenya (1913-1923). Muthaiga Water Supply. Kenya National Archives, Ref: AG/43/103, Nairobi, Kenya.

68 Colony and Protectorate of Kenya (1913-1923). Muthaiga Water Supply. Kenya National Archives, Ref: AG/43/103, Nairobi, Kenya.

Although the installation was to be done by the company to the satisfaction of the government all the assets connected with water supply would have to remain the property of the government. The supply to the area delineated to the company would have to be metered at the tank exit and the water was to be paid for a rate of 80 cents per 4.5 m³. The water supplied to the consumers would have to be paid for at the same rate as rest of the Municipality i.e. approximately 2 KES per 4.5 cubic metres⁶⁹.

The supply was considered as limited, at the time and hence the company was by use of metres to limit the water use to domestic and sanitary purpose. The government or the Municipality of Nairobi reserved the right to take over the company any time on paying the clients of the company the value in situ of the pipes and plant⁷⁰.

The actual agreement between the government represented by the Governor Sir Henry Conway Belfield and the company representative Captain James Archibald Morrison was signed in 1914. At the time the water supply was the property of the Uganda Railway, but the rates were being collected by the Municipal Corporation. It was contemplated that the water supply would be taken by the Municipal Corporation at later date when it had developed the capacity to run it. Thus the Uganda Railway was also a signatory to the agreement between the government and the Company.

The agreement was to last for 10 years before renewal could be necessary. The only provision for change would have been if a new water supply were to be developed by the government to supply the same area with water⁷¹.

The construction of roads and drains was taken over by the Public Work Department and the final details of the water agreement were known in 1923. The water undertaking was bought from the railways at a cost of £ 20, 000 payable with interest in twenty annual installments of £1743.53. For the first five years the Railways was to be supplied with water for all purpose free of cost and after that period at cost price. There was also an obligation on the council to supply water at equitable terms to government departments when required to do so. The opening of additional spring at Kikuyu to augment the supply cost the council further £2300 and the purchase of Muthaiga Estate supply cost £6500 in 1923⁷².

69 Colony and Protectorate of Kenya (1913-1923). Muthaiga Water Supply. Kenya National Archives, Ref: AG/43/103, Nairobi, Kenya.

70 Colony and Protectorate of Kenya (1913-1923). Muthaiga Water Supply. Kenya National Archives, Ref: AG/43/103, Nairobi, Kenya.

71 Colony and Protectorate of Kenya (1913-1923). Muthaiga Water Supply. Kenya National Archives, Ref: AG/43/103, Nairobi, Kenya.

72 Colony and Protectorate of Kenya (1913-1923). Muthaiga Water Supply. Kenya National Archives, Ref: AG/43/103, Nairobi, Kenya.

The arrival of the railway signified a turnaround in the status of Nairobi both as an administrative and commercial centre. The initial growth was however slowed down by World War I (1914 to 1918); then the economic slump of 1922; the locusts in 1928 and thereafter another economic recession of 1930s. However, even with all the above setbacks the growth of the town could be described as modest.

The water shortage and the need for new sources of supply had led to council to engage Mr. Maxwell, to report to them on possible new scheme of water supply. In September 1928, it was decided that the third scheme to be put forward the Ruiru River Scheme should be adopted and government was asked to support it. At the same time, other minor sources in the vicinity were prospected. A borehole was sunk at Dagoretti Corner in 1930, but it proved unsuccessful even after two explosives charges were detonated on it⁷³.

Eastleigh: By 1927, the Eastleigh Township still lacked access to Nairobi although a sum of 1,000 pounds was allocated for construction of an access road. The water supply of the township was still most unsatisfactory. The residents were dependent on two public wells, which invariably dried up during the dry months, and the polluted Nairobi and Mathare Rivers⁷⁴.

Ruiru Water Scheme: In November 1929, the Governor opened the new Ruiru water supply. The scheme had been worked at in details in 1928-1929 but the concluding months of 1929 saw the works broken down by heavy rains and floods and this caused some considerable revision of the plans.

Financial discussions further deferred the work and it was not until 1933 when hydrographic surveys demanded by the government had been obtained over a lengthy period of drought, that the final details were agreed. Messrs. Howard Humphrey & Sons of London were appointed consulting engineers and in the succeeding years the work of constructing 29 kilometre pipe lines, a modern filtration plant and a reservoir, and the modifications of trunk mains in town was carried out. At its opening in 1938, it was estimated that the new plant, costing something like KES 2.4 million, would provide 9092 m³ of water per day⁷⁵.

The scheme met with a lot of resistance from the Kiambu committee of the Nairobi district council. Many people who were riparian to the Ruiru River were apprehensive that their rights to the waters of the river could be lost.

73 James S (1950). A Jubilee History of Nairobi. Kenya National Archives. CUP: 307 .76SMA. 1950

74 Campbell W. F. G (1927). Ukamba Province Annual Report 1927. Kenya National Archives, PC/CP/4/2/3. 1927.

75 James S (1950). A Jubilee History of Nairobi. Kenya National Archives. CUP: 307 .76SMA. 1950.

It is important to note that a thorough investigation of the river profile as well as the river volumes at various sections especially at confluences with its tributaries and at its inflow to other major rivers. All who had earlier been permitted to draw water from the river were also investigated so as to find out the effect of the proposed scheme to take water from the river for use in the municipality.

It is interesting to note that the hydrographic monitoring of the Ruiru River started as early as 1895. According to a report by the acting hydraulic engineer at the time Mr. Tetley, the lowest flow in the Ruiru River in the years preceding 1932, had been experienced in 1896 and 1899 when the flow ranged between 1 and 2 cusecs. At the time the Athi River derived all its dry weather flow from the Ndarugu and Ruiru Rivers. It was thus reported that the Athi River had ceased to flow as far as up to Ol Donyo Sabuk, in 1899-1900. It was thus feared that if heavy diversions from the Ruiru River were permitted then such an incident would occur and hence bring untold suffering for the residents of the Ukamba province particularly in the Machakos and Kitui native reserves. On the basis of the foregoing findings thus described, the permit to divert water for use in the Municipality was refused.

This decision was contested bitterly by the officials of the Water sub-committee of the Nairobi Association namely Bargman, Carr, Scott and Dobson. In their letter of 16th June 1932, excerpted here in part:

The Public bodies to be satisfied were only two: the Nairobi District council (representing the European riparian owners) and the Native Land Trust Board (representing native riparian interests).

They argued that the figures of 1896 and 1895 could not be relied upon and as such the decision to refuse the permit was biased against them. It was then suggested that a scheme of water from the Lari swamp to supplement the flow in the Ruiru River could be acceded upon. Thereafter a definite quantity of water to the two aforementioned bodies could be worked out and clauses safeguarding the interests of all riparian owners inserted into the permit as well.

Howard Humphreys and sons were contracted in 1934 to undertake further investigation on the augmentation of water supply to Nairobi whose water consumption at the time had superseded the supply from Kikuyu springs. The average daily consumptions from 1931 to 1934 are as shown in Table 3.2⁷⁶:

76 Howard H.C.L (1934). Report on Ruiru water scheme. Kenya National archives, Ref: VQ/7/9, Nairobi, Kenya.

Table 3.2: Average daily water consumptions

Year	Amount (m ³)
1931	5545
1932	5102
1933	5242
1934	5557

The minimum recorded daily yield of the Kikuyu Springs was recorded as 501m³. At the time there was neither water nor storage to balance times of drought and times of plenty. However, serious effort had been put in place to control wastage⁷⁷.

It was considered that Nairobi could not rely on ground water for its heavy requirement for water, but rather on its several rivers emanating from the Kikuyu escarpment which rose northwest of the town. Since the Ruiru River was nearest of the rivers from which water was obtainable, it was inevitably the first to be investigated.

In his report, Howard considered that the boundaries of the town would change with time and that the population of the town will be altered both by growth with time as with change in boundaries. However, preliminary estimates showed that the population of the town had grown from only 4,367 in 1911 to 21,165 in 1931, including all the following populations Europeans, Indians, Africans/Goans and Arabs. Further, it was estimated from the above figures that the population of the town by 1965 would be 93,150⁷⁸.

In 1930, the Municipal engineer carried out some tests upon a large number of houses in the European, Indian, and Native areas. The presence of metres on the house service made the tests simple and the results were set out as shown in Table 3.3⁷⁹.

Table 3.3: Unit water demand rates

Race	Demand (litres per head per day)
Europeans	227
Indians	136
Substituted Natives	91
Others (Goans etc.)	136
Natives	68

77 Howard H.C.L (1934). Report on Ruiru water scheme. Kenya National archives, Ref: VQ/7/9, Nairobi, Kenya.

78 Howard H.C.L (1934). Report on Ruiru water scheme. Kenya National archives, Ref: VQ/7/9, Nairobi, Kenya.

79 Howard H.C.L (1934). Report on Ruiru water scheme. Kenya National archives, Ref: VQ/7/9, Nairobi, Kenya.

The basis of the figure was that, they permit a satisfactory sanitary standard for the various groups. Based upon the above figures Howard calculated the water needs for Nairobi up to 1965 at 6560 m³ per day. They however pointed out that there was a balance of the non-native areas which had not been installed with flushed latrines and he estimated that when this is done a further 564 m³ would be required to operate them. On the other hand it was viewed that Natives would also require some extra water for sanitary purposes, thus the total extra water need was put at 586 m³ per day. The water needs for Nairobi in 1934 was put at 5864 m³ per day. When summed up the total water needs for the town was put at 13393 m³ per day⁸⁰. The population of growth was significant to water development. Figure 3.6 is an illustration of Nairobi population between 1901 and 2005.

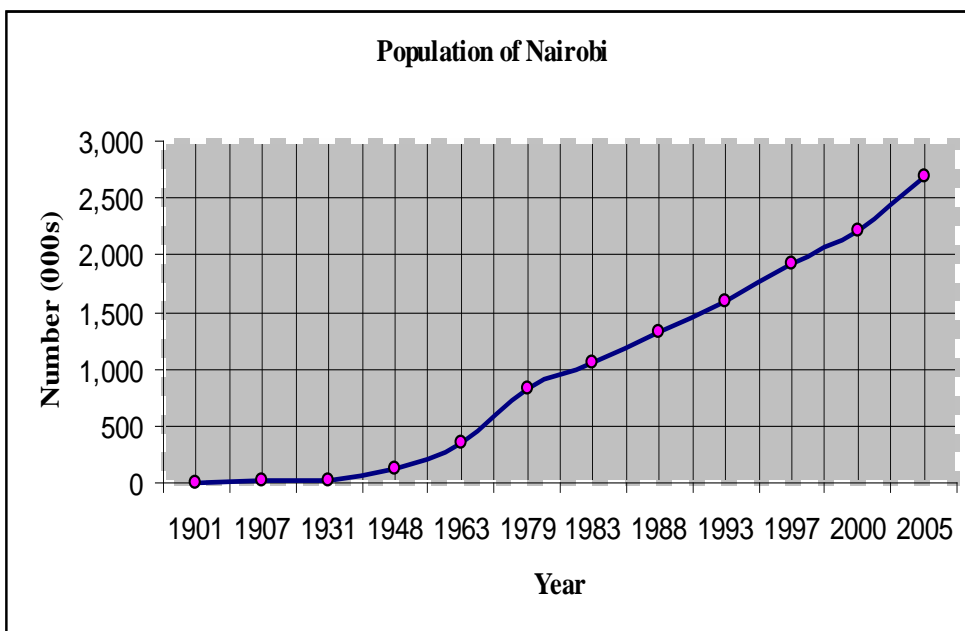

Figure 3.6: Population of Nairobi between 1901 and 2005⁸¹

The Kikuyu supply was providing 4905 m³ at the time and thus the balance of 8585 m³ was to be drawn from other sources and the Ruiru had as such been considered. After careful consideration of run-off of the Ruiru catchment, rainfall on the Ruiru catchment, the yield of the Ruiru and Bathi catchments, meteorological history of

80 Howard H.C.L (1934). Report on Ruiru water scheme. Kenya National archives, Ref: VQ/7/9, Nairobi, Kenya.

81 Republic of Kenya (2002a). National Development plan 2002-2008. Effective Management for Sustainable Economic Growth and Poverty Reduction. Government Printers, Nairobi, Kenya.

the period of gauging, compensation water and the probable relation of supply and demand Howard recommended a supply be extracted from Ruiru⁸².

The survey concluded that a dam could be constructed to impound a maximum of about 3 million cubic metres of water, However, not all the maximum impoundment would be required and the dam was built with a maximum impoundment of 107,604 cubic metres⁸³.

The site for the dam was examined and found to be underlain by trachyte. The ground was judged to be impermeable enough to hold the water to minimum seepage losses. Examination of the sediment load in the river revealed that not much silting problem was to be experienced. The intake site was chosen to be above the level of the river to avoid the complication of having to deal with the silt⁸⁴.

The pipeline was laid in 12" mains with flexible joints where necessary, while it was proposed to have the treatment plant at a raised point to give levels that would permit a good command to the whole municipal area. Howard also proposed the building of a second service reservoir of 4546 m³ to add to the already existing 4546 m³ steel tank, so as to form 9092 m³ reserve. This would permit repairs to water mains without serious water shortage to the municipal area. The reservoir was to be built in reinforced concrete as opposed to steel which had proved expensive to maintain⁸⁵.

On the issue of pressure in the town, Howard was of the opinion that it did not in fact cause any unnecessary wastage. In his opinion, pressure once abandoned cannot readily be recovered. He proposed that the high pressure could be kept due to small service lines and that in any case if the pressure proved to be undesired then a system of break-pressure valves or tanks could be used.

Howard recognized that much wastage was caused by faulty fitting and recommended that all fittings be inspected and stamped by the Municipal authority. With regard to instrumentation, he proposed that instruments should be installed to provide record to⁸⁶:

1. The intake works: The flow into the impounding reservoir; the flow below the waste weir to the lower reaches of the Ruiru; and the rainfall on the catchment

82 Howard H.C.L (1934). Report on Ruiru water scheme. Kenya National archives, Ref: VQ/7/9, Nairobi, Kenya.

83 Howard H.C.L (1934). Report on Ruiru water scheme. Kenya National archives, Ref: VQ/7/9, Nairobi, Kenya.

84 Howard H.C.L (1934). Report on Ruiru water scheme. Kenya National archives, Ref: VQ/7/9, Nairobi, Kenya.

85 Howard H.C.L (1934). Report on Ruiru water scheme. Kenya National archives, Ref: VQ/7/9, Nairobi, Kenya.

86 Howard H.C.L (1934). Report on Ruiru water scheme. Kenya National archives, Ref: VQ/7/9, Nairobi, Kenya.

- area. This would provide valuable information on the relationship between percolation, evaporation, run-off and abstraction.
2. The waterworks site: the flow to the treatment plant impounding reservoir; the flow of treated water to the town from the service reservoir; and the inflow from Kikuyu.
 3. In the town: Automatic pressure recorders at certain points.

The figures from these records were then to be entered into a log book and to be maintained in an easily readable graphical form so that unusual symptoms could be detected.

After a protracted tussle with the Native land owners, whose land was to be flooded with water impounded by the dam, the construction of the dam was only to begin in 1945. Although much of the design had been done earlier the dam construction was in fact partly held back by the World War II. During the period, which the dam construction was held in abeyance due to War, the population growth rate had been accentuated by the war so much so that no sooner had the dam been constructed than its supply to the city was superseded by demand.

The dam was constructed in 1945, with the aid of 100 Italian co-operators employed. After construction, the dam proved immediately insufficient for the needs of the people in Nairobi. The dam wall was later in 1947 extended to the maximum possible but could not still provide the required water needs even after the size of the delivery pipe had been doubled.

The water stress became so intense that some military units had to be moved to other places to relieve the consumption, campaigns on water conservation through the media was propagated and water-boring activities accentuated. The whole situation culminated in the invitation of a water expert Dr Kanthack to make investigation and recommendation on augmentation of water supply to the municipality.

At the beginning of 1943, the chief topic of conversation in Nairobi was food shortage. Drought had led to a crop failure and food shortages. A military water boring unit was engaged on drilling for additional water in various camps and on the fringe of, the municipal area. Water from these boreholes was pumped directly into the council's mains so that the daily consumption at the camps was easily offset by water pumped into town mains during night hours. Negotiations were going on for the release of twelve inch steel main by the ministry of supply in the United Kingdom so that the Ruiru pipeline could be laid⁸⁷.

Serious water problems existed in Nairobi in 1945, the water level in the dam had reached the lowest levels. The average intake had dropped from the low average

87 James S (1950). *A Jubilee History of Nairobi*. Kenya National Archives. CUP: 307 .76SMA. 1950.

quantities of 8619 m³ a day in July to an average of 8346 m³ a day, a further decrease of 273 m³ daily. The water level at the source was dropping daily and there was no sign of improvement.

The chairman of the Works committee Councillor G. G. Bompas in his comment to then East African Standard Reporter commented that:

“people see a spot of rain falling and assume that it is helping the supply and usually use a little more water in consequence. This is not the case. Rain in Nairobi did not in fact affect the sources of supply and it is up to everyone to economize rigorously. Unless they do so the very gravest menace to public health will result. I cannot stress this point too strongly”.

In an excerpt from the east African standard of 4th July 1945 titled “Water” a disgusted European who does not identify himself laments:

“For many months before we had no water at all, between the hours of 7a.m. and 7p.m. By contrast, the dwellers on the hill had had copious supply for 24 hours a day and our all-wise councillors recently decided that the Njoroges and Kamaus in that favoured district must continue to have their shower baths”⁸⁸.

The areas which were most affected by water shortage were Parklands, Westlands, Ngara and Fort Hall roads, the commercial areas, Native locations, railway area and Muthaiga due to the position.

Despite the stress of water shortage some areas enjoyed the luxury of having plenty of water by virtue of their being juxtaposed with important Hospitals and important Nursing homes.

However, some ingenious steps were taken to curb wastage. At the time it was seen as luxury for African to have showers and the fact that some Africans had showers raised anxiety. It was seen that if Africans used showers a lot of water would be wasted. As such during the day the showers on the African areas were fed through a special series of valves that gave a diminished flow. These areas were also cut off during sections of the day while at the same time their use was closely supervised. Water to such showers was cut off entirely from 6pm to 6am⁸⁹.

It was during this period of water crisis that a water expert from the Union Republic of South Africa was invited by the Government to a conduct a survey

88 The East African Standard (1945). Nairobi water Position still serious (6/7/1945) and (4/7/1945). Kenya National Archives.

89 The East African Standard (1945). Nairobi water Position still serious (6/7/1945) and (4/7/1945). Kenya National Archives.

of water possibilities in pursuance to resolution of a conference which had earlier been held in Nairobi. Dr. Kanthack conducted his survey in the Months of May and June 1945 in the area of the country between the Aberdare and Nairobi. The findings of his investigations are reported in his book “Report on the Augmentation of water supply for the Nairobi Municipal area” which was printed by Government printers in 1945. Some of the major conclusions for Dr. Kanthack’s investigation are outlined below⁹⁰:

- He advised the Resolution three of the conference on water about obtaining water in the upper reaches of the Chania River to be abandoned wholly as it was impracticable due to low flows in that section of the river.
- There were no sites from where stored surplus flood water, or any water in adequate quantity that, could be conveyed to Nairobi by means of gravity supply.
- There were no sites for dams and suitable storage reservoirs that existed on the upper reaches of any of the rivers within reasonable distance of Nairobi from which water could be pumped to a comparatively small height and from which water could be conveyed by gravity to the town.

From the above conclusions he made an overall deduction that the storage of surplus water to provide an adequate all-year-round source of water supply for Nairobi was impracticable. And that the only sources of supply remaining were Natural and Permanent River flows.

In 1945, Kanthack deduced that a supply of 56,826 m³ would have to be supplied to Nairobi in another 20 to 30 years. He concluded that such a flow could only be obtained from sections of the river where the minimum flow exceeded 56,826 m³. In his investigations, he found that Chania River was the nearest river from which such flows could be obtainable. Due to dry weather effect, Kanthack identified the best position for an intake just below the confluence of Kimakia and Chania. The rest would then be an issue of design considerations to find the best alignment, intake point and pipeline position to the Municipality⁹¹.

90 Kanthack F.E (1945). Report on the augmentation of water supply for Nairobi Municipality area. The government printers Nairobi Kenya.

91 Kanthack F.E (1945). Report on the augmentation of water supply for Nairobi Municipality area. The government printers Nairobi Kenya.

Drinking water in schools project

In 1940, the problem of drinking water in Nairobi Schools was raised and the Medical Officer of Health gave the following answers⁹².

The drinking water supplied through the mains in Nairobi was being chlorinated at source and was regularly checked bacteriologically in its distribution network and if any was found to be below the standard, consumers were advised to boil their water.

The domestic water-filter of whatever pattern was usually more of a menace than a safeguard. This was because of the reason that they were seldom or never regularly cleansed, and buildup of impurities took place, which artificially contaminated the water. He suggested that unless an absolute assurance of regular cleansing was to be done, it was advisable not to use the filters.

Unless boiled water was handled with complete protection against contamination after boiling, it was not being worthwhile boiling it.

The only way to supply drinking water to children safely was by the fountain system whereby a child drank direct from a jet of water. He also suggested that the problems of pressure could be solved by the installation of suitable storage tanks.

The best way of supplying drinking water was direct from the rising main, supplying a building and then the fountains should be connected direct with it. In addition, in cases owing to lack of pressure, properly constructed tanks with closely fitting covers were to be installed for the stored water. The tanks were to be subjected to regular inspection and cleansing.

Moreover, he considered that an ample supply of clean drinking water was a most important adjunct to the health of the children in very hot temperatures.

The standards for drinking fountains recommended in schools by the school medical officer were as follows⁹³: It was to be bubble or spray type-upward jet variety from which water was being delivered from a covered orifice to prevent children from getting their mouths over the nozzle; It was recommended that it should be one for every 100 children and at least two in a small school⁹⁴. The standards were to be the same for all the races.

It was further recommended that. Where two schools shared premises, which were meant to be occupied by one school the number of children to be taken was the maximum enrolment of the school, which was supposed to occupy the premises permanently. On the other hand, where buildings had been planned as an additions

92 Thomas A.T.G, M.D.B.S, D.PH (1949). Drinking Water-Nairobi Schools. Kenya National Archives. BY/35/18 Ref. MOH/W 1 13th July, 1949.

93 School Medical Officer (1949) Standards for Drinking Fountains in Schools. Kenya National Archives. BY/35/18 2nd, September 1940.

94 School Medical Officer (1949) Standards for Drinking Fountains in Schools. Kenya National Archives. BY/35/18 2nd, September 1940.

to the school, thus increasing the enrolment the number of children to be accommodated when the buildings was complete could also be taken into consideration⁹⁵.

The new schools under construction were supposed to be equipped with drinking water fountains and while doing so; the number of pupils who would attend the school was to be taken into consideration to determine the number of fountains to be installed. The location of the fountains was to be influenced to a large extent by water pressure at the schools⁹⁶.

In his letter in 1949, the Director of Medical Services stated that as long as water supply was impeccable, drinking fountains should be installed in all schools. In addition, he recommended that all Nairobi Schools should have drinking water fountains installed. This was the only way to ensure that a readily available supply of pure drinking water to schools was available⁹⁷.

In 1950, the Director of Medical Services observed that, there was a need for regular bacteriological check for the water supplies in Eldoret, Nakuru, Kitale, Kisumu and Nyeri. This was because, there was always a possibility of water being contaminated thus making it unsafe to drink tap water unboiled. For this reason, the installation of drinking fountains in schools outside Nairobi and Mombasa was not advisable. It was therefore recommended that:

Drinking fountains should be installed in all new schools to be built in Nairobi and Mombasa.

When funds permitted drinking fountains should be installed in all existing schools in Nairobi and Mombasa⁹⁸.

In 1950, the School Medical Officer inspected the drinking water facilities in Government Schools for all races in Nairobi and found them to be in terrible conditions recommended immediate nomination of a small committee consisting of; Medical Officer of Health, a Bacteriologist from the Medical Research Laboratory, a representative of the Director of Medical Services and the school Medical Officer. The committee was to look into the serious nature of the existing drinking water facilities and the necessity to prohibit the boiling and filtering of water in all Government

95 School Medical Officer (1949) Drinking Water Government Schools-Primary and Secondary, Nairobi Kenya National Archives BY/35/18 6th, September 1949.

96 School Medical Officer (1949) Drinking Water Government Schools-Primary and Secondary, Nairobi Kenya National Archives BY/35/18 6th, September 1949.

97 Astley B.A (1950) Standard for Drinking Fountains in Schools Kenya National Archives; BY/35/18 19th September, 1950.

98 Astley B.A (1950) Standard for Drinking Fountains in Schools Kenya National Archives; BY/35/18 19th September, 1950.

schools in Nairobi immediately. The committee was also to make available drinking water direct from the mains for all children in all schools in Nairobi. This meant that all intermediate containers were to be discarded unless the committee approved them. No school was supposed to be allowed to function unless the committee approved the drinking water facilities of that school⁹⁹.

Duke of York School: In 1950, no less than three boreholes had been in operation at various times since the school was opened¹⁰⁰.

The first borehole was inspected several times and found to be inadequate. This was because; there was no hut that was constructed over the apparatus, the condition of the floor and around the pumping and chlorinating apparatus was highly unsatisfactory. This matter was reported to the Education Department but no action was taken. The second borehole came into operation to supplement the first borehole. It worked better but after some time, the pumping apparatus collapsed and fell into the hole. The third borehole was in operation but there appeared to be some uncertainty about the operation of the pump and was said that if it failed to function, the first would be used and the water would be boiled¹⁰¹.

It was reported that electrical pumping and chlorination equipment were to be installed in Borehole No II and this was believed would be the permanent water supply. It was also believed that with the installation of the equipment no further treatment would be necessary for the school water supply. In addition, under such conditions drinking water fountains would be ideal¹⁰².

It was concluded that drinking water fountains was desirable at the Duke of York School but with conditions. The Director of Medical Services also said that drinking fountains at this school were very desirable but constant supervision of the purity of water at source was to be exercised¹⁰³.

Nairobi Primary School: In 1953 as a result of Medical Officers Report that stated that there was faecal contamination of water used in kitchen No 3 at this school, an inspection of the water supply was carried out by the School's Principal, Municipal Health Inspector, member of the Hydraulic branch and the School

99 School Medical Officer (1950) Drinking Water Government Schools, Nairobi. Kenya National Archives BY/35/18 Ref MTS/11/66 28th October, 1950.

100 School Medical Officer (1950) Drinking Fountain, Duke of York School. Kenya National Archives. BY/35/18 Ref MTS/11/68 9th December, 1950.

101 School Medical Officer (1950) Drinking Fountain, Duke of York School. Kenya National Archives BY/35/18 Ref MTS/11/68 9th December, 1950.

102 School Medical Officer (1950) Drinking Fountain, Duke of York School. Kenya National Archives BY/35/18 Ref MTS/11/68 9th December, 1950.

103 Director of Medical Services (1950) Drinking Fountain-Duke of York School. Kenya National Archives BY/35/18 20th December, 1950.

Medical Officer. The inspection revealed that all water in the three kitchens came from the 1.8 m³ tanks, and not from the mains¹⁰⁴.

It was then recommended that all the tanks should be cleaned out every school holiday¹⁰⁵. This work was to start immediately and weekly samples from the kitchen taps was to be collected by the Municipality Health Inspector for the next six weeks, and then tested by DR Cooke of the Medical Research Laboratory¹⁰⁶.

Kibera School: In 1953 the Water and Fire Committee was unable to provide a water supply at Kibera School. Nevertheless, according to the Medical authorities, the existing facilities for drinking water were unsatisfactory and they strongly recommended that piped water be supplied. It was further noted that a pipeline, which was laid from the mains in Newberry Road to the school for building purposes, was still in existence and it was a pity if the installation was to serve no further useful purposes. The City Water Engineers had also assured of no difficulty in supplying the small amount of water required, while the Education Department was prepared to give any guarantees council would require to make sure that the quantities drawn would not exceed any figure that would be laid down¹⁰⁷.

In 1954, an application for the water supply to Kibera School was referred to the Member for Health, Lands and Local Government, who replied that there was no point in putting more pressure on the city council since it had been done before. It was however, hoped that if Kibera was developed as an African Housing estate under the City Council a proper water supply would be provided. It was further noted that as long as the City Council was unable to meet all water demands within its area it could not be expected to meet the request outside as was the case with Kibera School. Therefore there was little that could have be done at the moment, however, it was believed that with the completion of Sasumua Scheme the Council would be very keen to sell as much water as it could thus supply of water to the school would be possible¹⁰⁸.

Limuru Girls' school: In 1959, the results of bacteriological water samples taken from various points within the school revealed that the water supply was unsatisfactory as it contained faecal coli form bacilli. It was recommended that a

104 School Medical Officer (1953) Water Supply Nairobi Primary School. Kenya National archives. BY /35/18 6th January, 1953.

105 School Medical Officer (1953) Water Supply Nairobi Primary School. Kenya National archives. BY /35/18 6th January, 1953.

106 School Medical Officer (1953) Water Supply Nairobi Primary School. Kenya National archives. BY /35/18 6th January, 1953.

107 Director of Education (1953) Kibera School. Kenya National Archives. BY/35/18 Ref 5/725/4/1/25/177 7th December, 1953.

108 Director for Education (1954) Kibera School Water Supply. Kenya National Archives. BY/35/18 Ref 5/723/4/1/25/191 13th March, 1954.

reputable firm of Water Engineers be engaged to overhaul the complete school water reticulation and supply and thereafter give advice on the best method possible¹⁰⁹.

Lugulu Girls High School: In 1964, there was no sufficient water supply for the schools and Health Centre as water had to be carried for about a one and half kilometers away during the parts of the year when there was insufficient rainfall. This was a serious hindrance to good health practices and the proper functioning of both the schools and Health Centre.

The lack of adequate water supply also made it difficult to recruit best-qualified staff members for the school and to anticipate the addition of a second stream for which there was a great need in the area and also there was some possibility of funds in the near future. In the same year, a dam was under construction just under a mile from Ligulu. This dam could Supply water to Lugulu Girls' High School, Lugulu Girls Intermediate School, and Lugulu Health Centre, as well as the neighboring dukas and other potential users as well¹¹⁰.

Thus, the schools through their heads applied for a grant of one-thousand pounds from the Ministry for Health and Housing so to acquire the materials needed to complete the water installation. The materials needed were as follows: 1220 metres of 2" water pipe; one six-horse-power diesel engine; one water pump and; one small building to house engine, pump, and diesel oil tank. At the high school already there was a 22.7 m³ storage tank placed on a 20-foot tower, pipes laid from the tower to the existing high school buildings, as well as to the Health Centre¹¹¹.

Harambee Secondary Schools: In 1967, the director for water development department said the Ministry had no provision for grant assistance for any form of water in the South Nyanza District that included the schools and similar Institutions¹¹².

He noted that financial provision for such supplies was the responsibility in the first place of the County Council of South Nyanza or alternatively of the body, such as the Board of Governors or the School Committee, which controlled such schools, possibly the Ministry of Education¹¹³.

He also noted that loan finance for this type of water development was available through the Local Government Loans Authority, which under prevailing arrangements could only deal with the County Council, and it appeared therefore that the

109 County Health Inspector (1959) Unsatisfactory Water Supply-Limuru Girls' School. Kenya National Archives. BY/35/18 23rd September, 1959.

110 Barret Leslie H and Hollinshead Estelle (1964) Luguru Girls High School. Kenya National Archives. BY/35/18 30th March 1964.

111 Barret Leslie H and Hollinshead Estelle (1964) Luguru Girls High School. Kenya National Archives. BY/35/18 30th March 1964.

112 Classen G A (1967) Harambee Secondary Schools-Water Supply. Kenya National Archives BY/35/18 9th January, 1967.

113 Classen G A (1967) Harambee Secondary Schools-Water Supply. Kenya National Archives BY/35/18 9th January, 1967.

first authority to be approached was the County Council. However, in doing so, one was to be in a position to assure the County Council that if they finance the water scheme, the regular payment for the water used would be made by the users¹¹⁴.

Trans Nzoia Secondary School: In 1968, the Chief Technical Officer reported that, a survey of the school had been conducted and the following information was collected. The school population was 360 people. These included students, teaching staffs and non-teaching staffs. The daily requirement was approximated to be a total 65 m³ per day¹¹⁵.

The water supply to the school was from a dam, which was located approximately 5,000 ft. from the school. It was recommended that although it could increase the distance by 600 ft. A pump and intake should be installed on the opposite side of the dam from the school. It was further recommended that arrangements were to be made to connect into an existing weir, which was being used by a local farmer for his pump intake. The conditions of the wall of the dam were very poor and it was recommended that some maintenance be carried out on it. The following equipment was required based on the supply, which was to be needed when the school would be fully staffed, and up to maximum enrolment. A pump, engine, base plate, pump house, piping, fittings and a tank. The approximate cost of all these equipment was 31,850 shillings¹¹⁶.

The Impact of World War II: The start of World War II saw the influx of many people into the city especially soldiers of different nationalities, Italians, Indians, Boers, Afrikaans, etc. This influx had in fact a positive impact economically, as a consequence of the market created. As will be seen later, this high population in Nairobi actually necessitated quick augmentation of water supply immediately after the War. Moreover, the soldiers themselves had to contribute to the development of water supplies by drilling boreholes, the supply of which was pumped into the distribution system. Later, some War Units had to be disbanded or relocated to other areas to ease pressure on water.

The shortage in water supplies for the Municipality of Nairobi in 1945 was partly caused by the large military presence in Nairobi. With the end of the War, most of the Military units were retained in the Municipality. When the water shortage went to acute proportions, the military through its boring department took an active role

114 Classen G A (1967) Harambee Secondary Schools-Water Supply. Kenya National Archives BY/35/18 9th January, 1967.

115 Spore Arthur L (1968) Trans Nzoia Secondary School-Water Supply. Kenya National Archives. AVS/6/8 Ref CEN/20/VOL 1/126 24th April, 1968.

116 Spore Arthur L (1968) Trans Nzoia Secondary School-Water Supply. Kenya National Archives. AVS/6/8 Ref CEN/20/VOL 1/126 24th April, 1968.

in providing water for some of its units requiring up to 45.5 m³ of water per day. In an excerpt entitled “Water for Nairobi from Old Lake beds, how army was working to relieve shortage” presented in the East African standard of 30th May 1945 it was stated that through the military program of sinking boreholes for its army units, some 50% of the military calls on Municipal water had been cut¹¹⁷.

Besides the contribution of the army in relieving water shortage in Nairobi, they also did admirable work elsewhere. A good example is the civilian water supply at Sultan Hamud which was derived from a borehole sunk for the Kenya Uganda Railways and Harbours and another at Donholm Road to supply a new Municipal housing estate for Africans. The army was also responsible for supplying the Mukonga reserve North of Nanyuki with water. The assistance between the army and the public works department was a mutual one. In the early days of the war the public works loaned a number of boring rigs to the army which were handed back. In addition there was a lot of geological data interchanged¹¹⁸.

Kabete Treatment Works: On November 16, 1938 the filtration plant at Kabete treatment works was opened by His Excellency the Governor. At the time the mayor of the Municipal council was Lady Delamere with Councillor T.A. Wood as her Deputy. The filtration plant had been planned since 1926. The Governor celebrated the occasion with a little piece of humour when he commented that:

“we have been a little bit anxious,... as to the possible effect on revenue from customs duties on spirits, which may come down as a result of this very excellent water supply”¹¹⁹.

The filtration plant had been built at a cost of about 11,000 pounds, while the scheme itself consisted of a new pipeline about 29 kilometres in length from the Ruiru River, the diversion of all pipelines from the Kikuyu springs to the filtration plant and the construction of a service reservoir close to the plant. The reservoir was constructed at a cost of 10,000 pounds.

The Nairobi dam, Chania-Sasumua and Ruiru Dam: The laying of the twelve-inch main to Ruiru assumed the character of a military operation. In January 1946, it was reported that an African artisan works company several hundred strong had been lent by the military from the Kenya and Uganda Railways and Harbour; the

117 E A Standard (1938). Water for Nairobi from Old Lake beds, how the Army is working to relieve Shortage (30/5/1945). Kenya National Archives.

118 E A Standard (1938). Water for Nairobi from Old Lake beds, how the Army is working to relieve Shortage (30/5/1945). Kenya National Archives.

119 East African Standard, (1938). Nairobi’s water, Governor opens filtration plant (17/11/38). Kenya National Archives.

Municipal Council was employing the number of Africans and artisans, and there were two contracting firms at work on a trench digging with their own large labour quotas¹²⁰.

At the same time the council was asking for new water conservation measures in town, reviewing its reserves and exploring possible dam sites. In March, in co-operation with Member for Agriculture and Natural scheme was put forward for the construction of an earth dam in the Mutoini River below the Royal Nairobi Golf Club. It was considered that the council should start work within seven days, working by floodlights if necessary, in order that the dam should be ready before the onset of heavy rains. The member added¹²¹,

“It must of course be appreciated that embarking on emergency work of this magnitude at short notice and without meticulous technical investigation must entail an element of risk. In other words, it is a gamble, which may however be justified by the present situation”.

The earth shifters moved in and the dam –now called the Nairobi Dam–was built. Although an apparent ‘white elephant’ for some time, the dam then was providing a quarter of 1137 m³ of water daily for consumption in Nairobi¹²².

The Sasumua Dam is located approximately 30km from Nairobi boundary. By the middle of 1946, there were two schools of thought on Nairobi’s water supply, one it would either have to be brought from a great distance or two pumped from a great depth- dams or deep wells. Dr. Parsons was carrying out geophysical surveys of more proposed dam sites at Mbagathi (at the junction of Athi and Kiserian Rivers) at Tusoga on the Ruaraka River. At the same time the Kabete and Chania-Sasumua scheme in the highlands was being surveyed. Some surveyors were in favour of sinking large boreholes in the municipal area and one such site was below Ainsworth Bridge.

When the preliminary gauging of the Chania was completed in October 1946, everything else was subordinated to the Chania scheme and early in 1947 it was adopted as the long term project. The other dam sites were abandoned and the idea of a deep-well boring, particularly with such sketchy knowledge of water bearing strata below the town, was dropped. By May 1946, the use of military boreholes was discontinued¹²³.

Work on the Ruiru dam was being done through direct labour and in November it was decided to raise the height of that dam to the safety margin in future

120 James S (1950). A Jubilee History of Nairobi. Kenya National Archives. CUP: 307 .76SMA. 1950.

121 James S (1950). A Jubilee History of Nairobi. Kenya National Archives. CUP: 307 .76SMA. 1950.

122 James S (1950). A Jubilee History of Nairobi. Kenya National Archives. CUP: 307 .76SMA. 1950.

123 James S (1950). A Jubilee History of Nairobi. Kenya National Archives. CUP: 307 .76SMA. 1950.

dry season. The decision to increase the height of the Ruiru Dam to 18 metres instead of 11 metres as originally planned also meant that the slower method of direct labour would have to be abandoned and work would have to be continued by contract. One of the large public works contracting firms from the United Kingdom obtained the contract¹²⁴.

In August the council's consulting engineers reported that they considered the Chania-Sasumua scheme a practical one. The dam was designed to hold 4546 m³ of the storm flows of Chania –Sasumua Rivers; the water was piped 64 kilometers to Nairobi and the scheme was approximately £750,000 and augmented Nairobi's water supply by 18,184 m³daily after completion in 1952¹²⁵.

Nairobi grew to become a communication centre and the headquarters of the provincial administration. It is not easy to talk about the History of Nairobi without mentioning the following milestones:

- In 1905 Nairobi became the capital of the Country.
- In 1919 Nairobi was appointed Municipal Council with corporate rights.
- In 1928 a new Municipal Ordinance extended the powers and responsibilities of the Council.
- In 1950 Nairobi became a City by Royal Charter of Incorporation.

Post-independence development of water supply has concentrated on what is known as the Chania project. Chania I was developed in 1972 and comprised the construction of an intake on Chania River. Water from the intake was pumped for treatment at Ngethu treatment works (Phase I), constructed under the same project. After treatment water is transmitted by gravity to Gigiri storage reservoirs from where it is gravitated to consumer outlets in Nairobi. The second exploitation of the Chania River Source was undertaken in 1984 as the Chania II project. The main feature of Chania II scheme was Construction of Mwagu weir on Chania River at a point far upstream to allow water to gravitate to Ngethu treatment plant. This was an improvement to the initial intake, which required pumping of the raw water to the treatment works.

The treatment works was expanded (phase II) to cope with the increased raw water supply. The third stage of development of the Chania sources constituted the Third Nairobi Water Supply Project (TNWSP), which was at its final stages of completion. Its main elements were:

124 James S (1950). A Jubilee History of Nairobi. Kenya National Archives. CUP: 307 .76SMA. 1950.

125 James S (1950). A Jubilee History of Nairobi. Kenya National Archives. CUP: 307 .76SMA. 1950.

- Damming of Thika river at Ndakaini.
- Raw water aqueduct from the dam to Mwangi intake on the Chania River.
- New raw water pipeline from Mwangi to Ngethu.
- Expansion of the treatment plant at Ngethu.
- Additional pipeline from Ngethu to Nairobi.

In 1948, a “Master Plan for a Colonial Capital” was prepared for Nairobi. The Master Plan contained proposals for zoning for residential, industrial and other uses and laid down for future physical development of the City. In addition it made proposals for road network and its extensions. On the whole the plan has been responsible for the layout and general development of the Old City area, which forms the core of the Greater Nairobi area. However, the plan underestimated the expected growth of the City and made some unrealistic recommendations that could not be sustained in the long run.

Nairobi Peri Urban Water Supplies: The Nairobi Peri-urban areas were considered in four natural areas i.e. South West North West, North East and South East. In July 1957, the Acting Chief Hydraulic Engineer prepared a report examining the sources of surface and ground water available for the supply for Nairobi Peri-urban areas. This included investigations of the adjacent African areas whose supplies could be met from the same sources and assessment of the present and future demands in these areas taking into account development for not less than 10 years. A report was prepared based on the findings of four other reports which had initially been prepared. The reports which were consulted include¹²⁶:

- Report on the Augmentation of the water supply for the Nairobi Municipal area by Dr. F.E. Kanthack, 1945.
- Water resources of Nairobi-Limuru-Kiambu District. P.W.D 1953.
- Report on Kabete Water Supply. Chief Hydrologist P.W.D., 1955.
- Nairobi Peri-urban Area Water supply Investigations by Grieve and Bridger, 1956.

Although the report under bullet (4) above was ordered by the Nairobi Urban District Council, the recommendations therein had not been implemented by 1957¹²⁷.

The supply to African areas was considered unfeasible due to the following difficulties:

¹²⁶ Chairman’s Report (1957). Nairobi Peri- Urban Water Supplies. Kenya National Archives, Ref: WAT/ 36/24/212, Nairobi, Kenya.

¹²⁷ Chairman’s Report (1957). Nairobi Peri- Urban Water Supplies. Kenya National Archives, Ref: WAT/ 36/24/212, Nairobi, Kenya.

- The demand of water for African areas could not even be approximated.
- A detailed contour map was prepared and hence it was difficult to make an assessment of those areas that could come under gravity command etc.
- The local administration was already proceeding with its own schemes for supply to new African villages from rivers and boreholes.

As a consequence the African areas were actually withdrawn from consideration under Peri-urban areas¹²⁸.

Development of the Peri-urban Areas: The North West area, which included Kabete, was already being supplied with water from a borehole. However, the supply from the borehole was considered inadequate for immediate and future demands. Kabete was to be considered integrally with the rest of the North West for development.

Earlier reports on the Nairobi Peri-urban water supplies had excluded the estimates for the North East area for quarry, recreational, agriculture and undeveloped zones on the grounds that such supplies at the time were being drawn from boreholes and would not normally fall within the province of a water undertaking. The North East area was however to be later included in the investigation for the future. The South East area, which included Embakasi Township, had already been investigated by 1957 and the demand had been put at 330,000 gpd for a 10 year period from 1957¹²⁹. The Needs for each peri-urban area as calculated in 1957 are presented in Table 3.4.

Table 3.4: Water demand in peri-urban areas of Nairobi

Area	Water demand (gpd)		
	Present	Within 10 years	Within 20 years
South West	230,000	450,000	600,000
North West	160,000	300,000	500,000
North East	470,000 plus	850,000 plus	1,070,000 plus
South East	-	200,000	300,000

There was a serious depletion of ground water resources in parts of the North Eastern area, notably in the vicinity of the breweries, which had already led to the declaration of the Ruaraka water conversation area, and had resulted in the proposal to declare

128 Chairman's Report (1957). Nairobi Peri- Urban Water Supplies. Kenya National Archives, Ref: WAT/ 36/24/212, Nairobi, Kenya.

129 Chairman's Report (1957). Nairobi Peri- Urban Water Supplies. Kenya National Archives, Ref: WAT/ 36/24/212, Nairobi, Kenya.

an additional water conservation area covering the South West and North West peri – urban districts. The imposed restrictions on borehole abstraction in the N.E. area made it essential to seek water supplies from other sources as a matter of urgency¹³⁰.

Further sources of supply for the North Eastern and parts of the North Western area (Kabete and possibly Roselyn Estates) were proposed to be sought with urgency. Suggestions had been made for a comprehensive rising main type of supply feeding all the peri-urban areas.

In the North West and North Eastern areas Ground water could not be augmented any further. Bridger report recommended the use of boreholes at Kahawa which were drilled by the P.W.D. for the military authorities, but were not in use. The impending development of the colony as a military base made it unlikely that those boreholes would become available for urban supplies. Development of other borehole supplies outside the peri –urban area would require detailed investigation before recommendation could be made¹³¹.

The existing surface supplies included bulk supplies from the Sasumua – Nairobi pipeline. Tapings from this main were expected to command gravity supply to both the North West and North East areas, except Kabete, where pumping would be required. The scheme was particularly suitable for the supply of the North West area as it crossed all the ridges along which were several residential estates. The amount of additional pipe work required was, therefore, a minimum. The Sasumua supply was treated at the headworks¹³².

However, the high cost (approx. KES 4/25 per 4.5 m³) of the bulk supply, to which had to be added costs of reticulation, the possibility that water demand in the city might increase to a point where peri – urban supplies could no longer be maintained were major challenges. The condition laid down by the city council that offer to supply peri – urban areas was dependent upon the extension of their permit for the use of Kikuyu springs was also a headache.

Kikuyu Springs: Records of the actual flow from the springs were not made, but the recorded abstractions by the city council varied from 3114 to 7501m³ per day, and it was considered that an average flow of 5000m³ per day was available from those springs already tapped¹³³.

130 Chairman's Report (1957). Nairobi Peri - Urban water supplies. Kenya National Archives, Ref: WAT/ 36/24/212, Nairobi, Kenya.

131 Chairman's Report (1957). Nairobi Peri - Urban water supplies. Kenya National Archives, Ref: WAT/ 36/24/212, Nairobi, Kenya.

132 Chairman's Report (1957). Nairobi Peri - Urban water supplies. Kenya National Archives, Ref: WAT/ 36/24/212, Nairobi, Kenya.

133 Chairman's Report (1957). Nairobi Peri - Urban water supplies. Kenya National Archives, Ref: WAT/ 36/24/212, Nairobi, Kenya.

The surface water resources of the area of the Athi catchment lying between the Kamiti and Mbagathi Rivers were found to be small. During very dry periods the streams in the area could be sustained entirely by their head springs, the total discharge of which under such conditions was less than 6 cusecs. This figure included 4906 m³ from the Kikuyu springs. It was clear, therefore from hydrological consideration alone, that any scheme for surface water abstraction in this area would involve an impounding reservoir. Additionally, appreciable quantities of compensation water were required for users below the dam sites. The following sources were considered¹³⁴:

1. Mbagathi River, with estimated yield of 4546 m³ per day.
2. Nairobi River, with estimated yield 1137 m³ per day.
3. Mathari River, where a private developer was constructing a dam at this site for coffee irrigation.
4. Getathuru River, near Kitisisuru estate, with estimated yield 864 m³ per day.
5. The confluence of the Getathuru and Matundu Rivers with an estimated yield 2173 m³ per day.
6. Matundu River with an estimated yield of 486 m³ per day.
7. Karura River, with an estimated yield of 1818 m³ per day.
8. Ruaraka River at with an estimated yield 3819 m³ per day.
9. Kiu River, at Nairobi – Kimiti Road crossing by then used by a private estate for irrigation.
10. Kamiti River, with an estimated yield at least 2091 m³ per day.
11. Makuyu River, with an estimated yield 1364 m³ per day.

These sites were subject to only surface investigation and a detailed study was required to confirm their suitability for water storage. The estimate useful yields required rechecking with a more recent hydrological data and the requirements of the down – stream users. Nevertheless, they indicated that surface water supplies was obtainable from comparatively local sources by means of impounding flood water and (in most cases) pumping¹³⁵.

The nearest stream offering a possible gravity flow of reasonable magnitude without an impounding reservoir was the Ndaragu, the minimum recorded flow of was 4.2 cusecs, a direct intake of 7274 m³ necessary to supply the North Eastern and North Western areas.

134 Chairman's Report (1957). Nairobi Peri - Urban water supplies. Kenya National Archives, Ref: WAT/ 36/24/212, Nairobi, Kenya.

135 Chairman's Report (1957). Nairobi Peri - Urban water supplies. Kenya National Archives, Ref: WAT/ 36/24/212, Nairobi, Kenya.

This scheme would involve the location of a treatment works at the upstream end of the trunk main, to control tubercular growths in the pipe, and the operation of this works in such a remote district would present some difficulty. Main storage would be provided at the peri-urban areas.

Chania River recorded low flow at Thika Township was 51 cusecs, so that a direct river intake was possible. Further abstraction from this river, however, was to be controlled by the overall limitations imposed by the seven Forks scheme¹³⁶. The total cost was 397400 pounds and distributed as illustrated in Table 3.5.

By 1957 there were 17 Gazetted private Water undertakers, these were: Spring Valley Estate, Roselyn estate, Ridge ways estate, Mwituu estate, Kibigara estate, Ruaraka Mango Farm, Garden Estate (now under the ministers control), Roysambu estate, Karen estate, Kitisuru estate, Kuwinda estate, Kisembe estate, Mirema estate, Tigoni estate, Kirawa water Co. Ltd, Kikuyu estate, and Green hills estate (near Limuru.). The secretary for works was undertaker for public water – supplies at Kabete, Nairobi west, Limuru, Ruiru, Kiambu and Barton estate¹³⁷.

Table 3.5: Summary of scheme costs

Name of the scheme	Capital cost (£)
Supplies Serving both North East and North West areas of Nairobi	
Sasumua Pipeline	144,000
Ndaragu Pipeline	907,000
Thika River	557,000
Ruiru River	442,000
Kikuyu Spring and Karura/ Ruaraka Dams	541,000
Kikuyu Spring and Ruiru River	420,000
Supplies serving North West area only	
Sasumua pipeline	33,000
Kikuyu Springs	153,000
Kamiti Dam	206,000
Supplies serving North West area only	
Thika River	353,000
Ruiru River	267,000
Sasumua Pipeline	115,000
Ndaragu Pipeline	562,000
Karura/Ruaraka Dam	388,000
Total Cost	5,088,00

136 Chairman's Report (1957). Nairobi Peri - Urban water supplies. Kenya National Archives, Ref: WAT/ 36/24/212, Nairobi, Kenya.

137 Chairman's Report (1957). Nairobi Peri - Urban water supplies. Kenya National Archives, Ref: WAT/ 36/24/212, Nairobi, Kenya.

Water Supply Embakasi Airport: The local area (as defined in the International Sanitary Regulation) of Nairobi Airport was situated within the area of the Nairobi County Council and was staffed and administered by the Ministry of Works and Communication through the Airport Commandant. The water supply to the terminal and the surrounding buildings was drawn from boreholes within the airport area. There were eight boreholes available of which three- Nos. 1, 4 and 8 – were in use then. (The water Supply Operator or one of Mr Edwards’ staff could pinpoint the exact locations) ¹³⁸.

Water from the boreholes was piped to the base of the water tower, chlorinated and pumped to the high level tank for purification and redistribution. There were three large storage tanks on the roof of the terminal building. The nearest to the waving base had recently been cleared and chlorinated and the other two were due for cleaning by MOW the soonest possible. Bird- proofing the tanks was advised.

The water was of good bacteriological and chemical quality, except for the fluorine content which varied from 9-11 pm.

The outgoing Port Health Inspector advised bacteriological sampling once a week (2 to three samples from different points) and chemical sampling bi-monthly. The aircraft water supply–point required surveillance and provided a convenient sampling point. The transferring of water from that point to aircraft required periodical attention and supervision. The airlines representatives were to advise on the procedure and standards adopted by the various companies¹³⁹.

The General Service unit camp drew water from its own borehole. The supply was chlorinated and samples taken during the previous two years had proved to be a satisfactory quality.

Water supply at Athi River Prisons was from two boreholes, was chlorinated and was satisfactorily then. At Langata Women’s’ prison Routine sampling of the water supply was advised. A chlorination plant was due to be installed over the borehole as a result of bad sample already taken¹⁴⁰.

Embakasi Prison: In 1953, prisoners’ garret type housing in corrugated aluminium was designed for use at Embakasi. It was proposed to have at least two courses built of stone and its occupation based on the international standards of floor area per person.

138 Port Health Inspector (1982). Handing Over Notes: Port Health Office. Nairobi Airport. Kenya National Archives. BY/129/15. September 11th 1982.

139 Port Health Inspector (1982). Handing Over Notes: Port Health Office. Nairobi Airport. Kenya National Archives. BY/129/15. September 11th 1982.

140 Port Health Inspector (1982). Handing Over Notes: Port Health Office. Nairobi Airport. Kenya National Archives. BY/129/15. September 11th 1982.

The number of prisoners and staff by September 1953 were 2000, initially 100 in tents, later 1600 plus 300(staff). Old army borehole provided water for the camp¹⁴¹. The pit that was being used for the disposal of night soil was only 45yards from the borehole that supplied water for the G.S.U water and there was a danger of the water supply being contaminated. The health inspector recommended closure of the borehole and provision of alternative source of water supply and night soil disposed at least 150yards from the borehole¹⁴².

Augmentation of water supply and provision of refuse bins at the rate of one bin for every twenty persons were also proposed¹⁴³. Water was drawn from a borehole in the camp and chlorinating was anticipated¹⁴⁴.

Nairobi Water Supply Projects: By 1996, the Nairobi's original source of raw water, the Kabete Scheme a system that includes Kikuyu springs (constructed in the early 1900s); the Ruiru dam on the Ruiru River (constructed in 1939); and the Sasumua dam on the upper reaches of the Chania River (constructed in two phases, in 1956 and 1966) supplied a total capacity of about 80,000 cubic metres daily. Their transmission pipelines met at Kabete, near the city center, which also was the site of a treatment plant and the main storage reservoir. The capacity of the Kabete scheme had become critically insufficient even for the higher-elevation areas supplied by the Kabete reservoir, let alone the city center; water shortages became increasingly common almost throughout the 1970s and the early 1980s¹⁴⁵

Nairobi Water Supply Project I and II: Between 1970s and 1996, the population of Nairobi had tripled severely straining basic infrastructure. By the early 1970s, the quality of services and maintenance of facilities had deteriorated, as had the capacity of Nairobi's municipal government to address these shortcomings. During the period, the World Bank supported three projects to augment sources of potable water supply for Nairobi and to create and then strengthen the Water Supply and Sewerage Department of the Nairobi City Council. The first project approved by the Bank was the Nairobi Water Supply Project (WSI), followed by a series of projects: The Nairobi Sites and Services Project (Urban I), the Second Nairobi Water

141 Senior Health Inspector (1953). Embakasi Prison Camp. Kenya National Archives, BY/6/29. 3rd September 1953.

142 Health Inspector, Nairobi Prisons and Detention Camps (1957) Former Mau Mau Investigation Centre-Embakasi Water Supply Kenya National Archives, BY/6/29, Ref: 33/335/114. 15th November 1957

143 Maxwell D.C (1959). Embakasi Prison Camp. Kenya National Archives, BY/6/29, Ref: 2/AP/147.

144 Russel E.M (1959). General Service Unit Company-Nairobi Airport. Kenya National Archives, BY/6/29, Ref: 18/GSU/4.10th August 1959.

145 The World Bank (1996). Kenya Evaluation Development of Housing, Water Supply and Sanitation in Nairobi. Report No. 15586 of April 25 1996. Operations Evaluation Department, world Bank

Supply Project (WS II), and the Second Urban Development Project (Urban II). As WS II implementation was winding down, NCC prepared, and the Bank agreed to finance, the Third Nairobi Engineering Project to strengthen the Council's Water and Sewerage Department. The physical components of the water supply projects were implemented as designed, but procurement and contracting problems led to delays in implementation and to cost overruns. All physical components of the first urban project were implemented as designed, but institutional weaknesses with the second urban project led also to time and cost overruns¹⁴⁶.

The two water projects sought primarily to expand the supply of potable water to Nairobi by rehabilitating or constructing facilities to collect and treat raw water and then transfer the treated water to the city. The major component of the projects was the stepwise construction of the Chania scheme. The projects were also to expand the primary distribution network, particularly to the new residential developments and the industries in the eastern section of the city. WS I was to meet projected demand for a population of 1.1 million to the early 1980s; WS II was to augment that capacity by meeting the projected water requirements of 1.5 million by 1988¹⁴⁷.

WS I was also to develop an institutional mechanism for improving the efficiency and effectiveness of water and sewerage activities in Nairobi. WS II was to provide skill enhancement to WSD staff in accounting, management, and water treatment. The Engineering Project was implemented to further strengthen WSD's operational and financial management and improve its staff training program development¹⁴⁸.

Supply capacity has largely kept pace with the population growth, and the availability of water has steadily increased as a result of the water supply projects which comprised new facilities for collecting and treating water from the Chania River as well as improvements to water distribution. Later, programs for leak-detection and rehabilitation, and metering house connections were implemented, thus improving the efficiency of the system. A water tariff restructuring in 1978 followed by regular price increases kept the WSD financially viable. To make water affordable to the poor, WSD increased the number of water kiosks and maintained low tariffs for kiosk operators. Yet, operators charged consumers up to six times the lowest rate for house connections, despite efforts to regulate kiosk operations through licensing. New approaches suggested pursued included kiosks operated by NGOs and community groups. The beneficiary survey revealed that consumers perceived water

146 The World Bank (1996). Kenya Evaluation Development of Housing, Water Supply and Sanitation in Nairobi. Report No. 15586 of April 25 1996. Operations Evaluation Department, world Bank

147 The World Bank (1996). Kenya Evaluation Development of Housing, Water Supply and Sanitation in Nairobi. Report No. 15586 of April 25 1996. Operations Evaluation Department, world Bank

148 The World Bank (1996). Kenya Evaluation Development of Housing, Water Supply and Sanitation in Nairobi. Report No. 15586 of April 25 1996. Operations Evaluation Department, world Bank

quality as satisfactory but saw only minor improvements in reliability and standard of supply. The price of water was felt to be too high, especially in the low-income, unplanned areas¹⁴⁹.

Nairobi Third Water Supply Engineering Project: Nairobi being the economic, administrative, social and cultural centre of Kenya, its water demand projections took into account the following parameters:

- General economic background of Nairobi's National economy and Nairobi
- Population trends and demography
- Future urban development of Nairobi
- Water demand projections for Nairobi

It is also the major industrial and financial centre, supported by an extensive transport and communication network, which connects with all other parts of the country¹⁵⁰.

In 1985, Nairobi had a population of approximately 1.2 million, 6% of the National total and growing at a rate of 5.3% a year. Approximately 36% of the Nairobi population were economically active. The major employment sectors were services (32%), manufacturing (19%), trade (18%), Construction (10%) and finance (9%). The formal wage-earning sector comprised of 85% where informal sector was 15%. There was a steady trend in rural-urban migration (Table 3.6). In terms of future development, the size and growth of population were among Kenya's most pressing problems, which, in turn generated an ever-increasing need for food, housing, employment and social welfare facilities¹⁵¹.

149 The World Bank (1996). Kenya Evaluation Development of Housing, Water Supply and Sanitation in Nairobi. Report No. 15586 of April 25 1996. Operations Evaluation Department, world Bank

150 Severn-Trent Water Authority, Howard Humphreys (Kenya Limited) and Howard Humphreys & Partners (1986). Third Nairobi Water Supply project: Organisation, Management and Finance Study. Nairobi City Commission.

151 Severn-Trent Water Authority, Howard Humphreys (Kenya Limited) and Howard Humphreys & Partners (1986). Third Nairobi Water Supply project: Organisation, Management and Finance Study. Nairobi City Commission.

Table 3.6: Population growth in Nairobi (1962 to 1985)

	Nairobi	Kenya
Area (km ²)	684	564,000
Period	Population (x10 ⁶)	
1962	0.347	8.636
1969	0.509	10.943
1979	0.859	16.141
1985	1.162	20.333
	Annual growth rate (%)	
1962-1969	5.6	3.4
1969-1979	5.3	4.0
1979-1985	5.3	4.1
	Density (persons/km ²)	
1962	3,855	15
1969	744 (borders extended)	19
1979	1,256	29
1985	1,699	36

By 1985, the urban planning in Nairobi was still largely guided by Nairobi Metropolitan Growth strategy (NMGS) of 1973, which laid out a development plan to the year 2000.

This strategy was based on minimum population growth of 2.9million. However, the implementation did not keep pace with the proposed programme because¹⁵².

- Population growth was slower that predicted in the 1973 Urban Master Plan.
- Population densities increased in well-established areas.
- Some planning parameters changed.
- The City lacked sufficient financial resources and organisational capacity.
- The City boundary had not been extended.
- Housed building had not been able to keep pace with demand which in turn had led to increasing development of shanty areas like Kieran and Mathare Valley.

Figure 3.7 shows the water sources, treatment and distribution map of Nairobi by 1996.

¹⁵² Severn-Trent Water Authority, Howard Humphreys (Kenya Limited) and Howard Humphreys & Partners (1986). Third Nairobi Water Supply project: Organisation, Management and Finance Study. Nairobi City Commission.

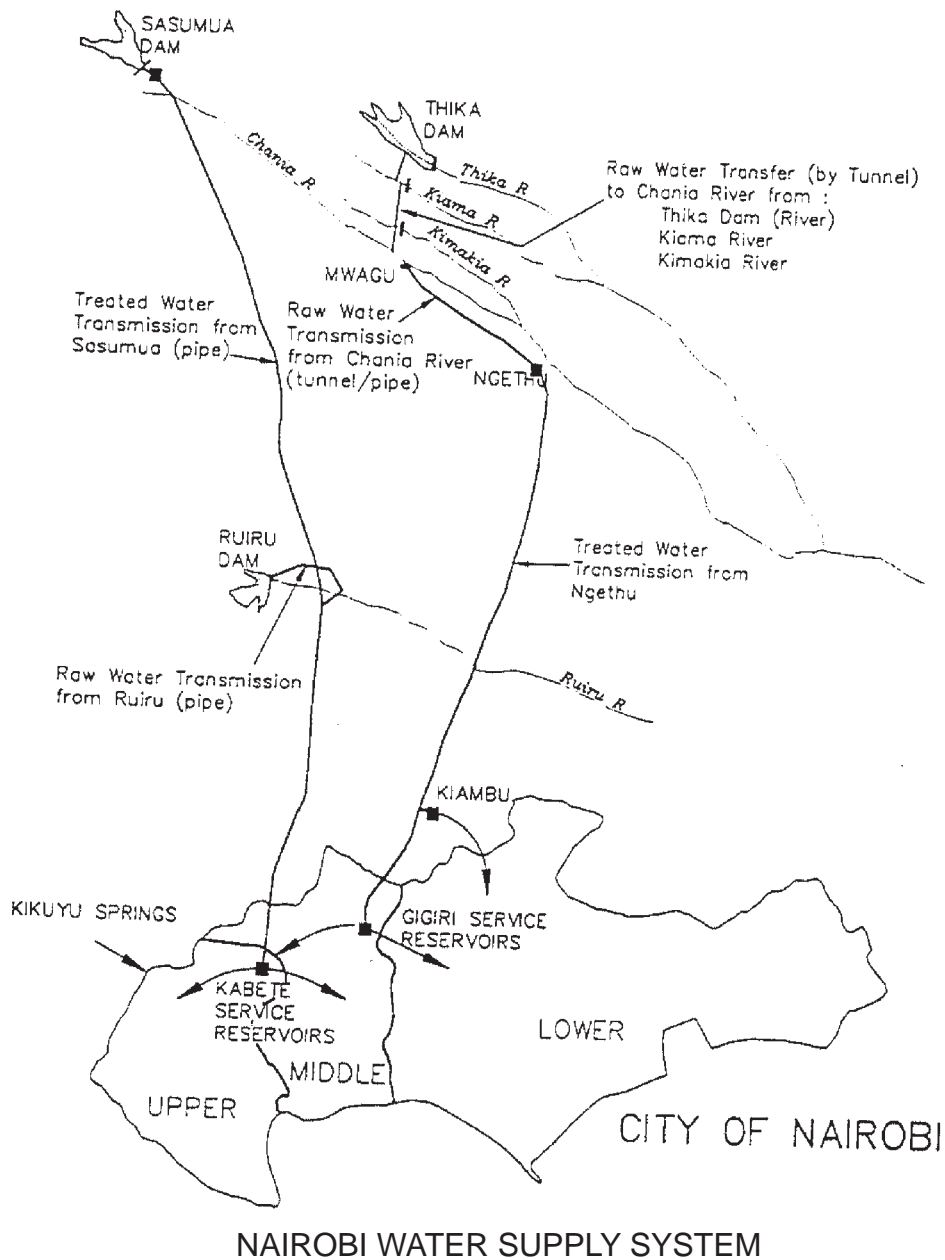

Figure 3.7: Nairobi water supply system by the year 1996¹⁵³

153 Howard Humphreys Kenya Ltd (1996). Nairobi Water Supply: Operating Philosophy. Nairobi city Council, Water and Sewerage Department Nairobi.

Water demand projections: By 1985, the urban area of Nairobi was served by a piped water distribution system supplying conventionally treated water from three major sources (Ruiru and Sasumua reservoirs and Chania River) and one minor source (Kikuyu springs). Kikuyu springs were developed over number of years commencing 1906. Supplies were taken off on route to Kabete and the residue was treated together with Ruiru water at Kabete. The maintainable yield was approximately 4,000 cubic metres. Ruiru supply was originally piped from the Ruiru River in 1938; a dam was subsequently constructed and completed in 1950. Three water pipelines of 9", 12" and 16" diameter, approximately 9.5km long transmitted water to Kabete water treatment works. The reliable yield of Ruiru was 21,400 cubic metres. Sasumua was developed over three stages commencing 1956 and completed in 1968. The source comprises of a dam, impounding reservoir and 5 river diversions. The works were connected to Kabete by a series of 24", 21", 18" and 12" mains approximately 61 kilometres long. Water was treated at source and its reliable yield was 57,000 litres per day (if no allowance was made for water released to Chania River of 45,800 if allowance was made for regulated water)¹⁵⁴.

In addition, some areas in the City were still being supplied by boreholes, either as an only source or a supplementary source to other supplies, Kitisuru, Karen, Langata, Dagoretti and other parts of eastern extension serving approximately 150,000 people. Some industries supplemented the water received from the mains system with additional water from their own boreholes amounting to 3500 to 3700 litres per day. Thus, approximately 13,000 litres per day were extracted from ground water sources in Nairobi¹⁵⁵.

Unaccounted for water was estimated at between 11% and 20% of the total input, which was an excellent performance by international standards. In mid to late 1970s, both water and sewerage department and the World Bank accepted that unaccounted sources were as low as 16% to 17%, in mid 1980s, the estimated for unaccounted for water rose sharply to 40% of the water supplied. This estimate came from a leakage and wastewater study carried out by French consultants on behalf of water and sewerage department in 1983. Lack of adequate, reliable and readily available information regarding distribution of consumption by consumer category was a major challenge in development works up until 1985¹⁵⁶.

154 Severn-Trent Water Authority, Howard Humphreys (Kenya Limited) and Howard Humphreys & Partners (1986). Third Nairobi Water Supply project: Organisation, Management and Finance Study. Nairobi City Commission.

155 Severn-Trent Water Authority, Howard Humphreys (Kenya Limited) and Howard Humphreys & Partners (1986). Third Nairobi Water Supply project: Organisation, Management and Finance Study. Nairobi City Commission.

156 Severn-Trent Water Authority, Howard Humphreys (Kenya Limited) and Howard Humphreys & Partners (1986). Third Nairobi Water Supply project: Organisation, Management and Finance Study. Nairobi City Commission.

Between 1975 and 1980s, domestic consumption increased slightly as a proportion of the total while the other categories fell slightly with the exception of the government sector. Domestic consumption accounted for about 60 to 63% of the billed consumption, commerce 15 to 16%, Industry 8 to 10%, government 11 to 12% and NCC 2 to 3%. In 1975, the water and sewerage department estimated that 82% of the City's population were served from the mains system; by 1985 approximately 89% of the City population were served through direct house connections, communal watering points and kiosks in the shanty areas¹⁵⁷. Leakage was common at most of water points where taps were insufficiently robust or had been damaged by the consumers (figure 3.8). This led to increase of the unaccounted-for water¹⁵⁸

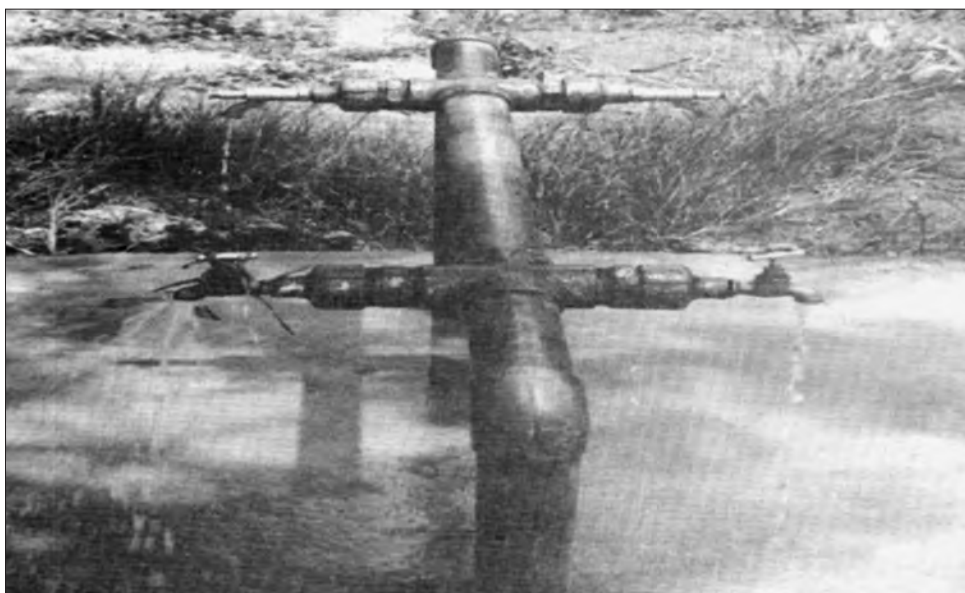

Figure 3.8: Leakage leading to unaccounted-for water¹⁵⁹

Water demand projections by 1985: The medium water demand projections contained two important assumptions: (a) the proportion of the population served was expected to rise from 89% in 1984-1985 to 95% in 1995 and remain constant

157 Severn-Trent Water Authority, Howard Humphreys (Kenya Limited) and Howard Humphreys & Partners (1986). Third Nairobi Water Supply project: Organisation, Management and Finance Study. Nairobi City Commission.

158 Republic of Kenya (2008). Bulk Water Supply System: Feasibility Studies, Identification of Institutional Support. Ministry of Water and Irrigation on behalf of Coast Water Services Board by BBL ingeniens consultants with Gibb Africa Ltd.

159 Republic of Kenya (2008). Bulk Water Supply System: Feasibility Studies, Identification of Institutional Support. Ministry of Water and Irrigation on behalf of Coast Water Services Board by BBL ingeniens consultants with Gibb Africa Ltd.

thereafter and (b) unaccounted for water was by 1985 estimated at 40% of production, it was assumed that the proportion of the unaccounted water would reduce to 25% by 1990 and 20% by 1995¹⁶⁰.

The need for storage: up until 1985, the average water demand exceeded the total average supply for dry season flows of all the rivers. This created the necessity for storage in the system. By this time storage had been provided by Sasumua dam, however, it was fully utilized and further supplies could only be assured by the provision of extra storage¹⁶¹.

Water distribution system: Over the years, Nairobi water distribution network has extended to most parts of the city. Out of an area of 693km² within City boundary, 540km² are served with the council water supply. In the TNWSP, it was estimated that of the total projected Nairobi population in 1995 of 1,950,000, approximately 1,853,000 would be served directly by the NCC water reticulation coverage of 95%

The water treated at Ngethu was transmitted to Nairobi through three main pipelines of diameter 700mm, 1000mm and 1400mm to Gigiri reservoir. The 1400mm pipelines had a branch at Kiambu extending eastward to a reservoir at Kasarani that served Kasarani – Githurai area.

From the Gigiri reservoir the water gravitated to Karura reservoir from where the consumers in Karura – Muthaiga were served. Karura reservoir was connected to Outer Ring Road water tower and served eastern part of Nairobi. The distribution network from Gigiri reservoir served parts of Westlands, Parklands, Eastleigh, Eastlands and industrial area.

Kabete treatment works received untreated water from Kikuyu springs and Ruiru Dam. After treatment the water was joined with treated water from Sasumua Dam and treatment works. Part of the water was diverted to the Loresho Water Tower for Consumption in Loresho area. Under the TNWSP water was pumped from Gigiri reservoir to the Kabete reservoir.

From the Kabete Reservoir water was pumped to Uthiru and Dagoretti reservoirs. Uthiru reservoir served Uthiru, Kabete, Kangemi, and Riruta- Kawangware. Water from Dagoretti reservoir was distributed to Karen area and gravitated to Karen reservoir to serve Karen-Langata area.

160 Severn-Trent Water Authority, Howard Humphreys (Kenya Limited) and Howard Humphreys & Partners (1986). Third Nairobi Water Supply project: Organisation, Management and Finance Study. Nairobi City Commission.

161 Severn-Trent Water Authority, Howard Humphreys (Kenya Limited) and Howard Humphreys & Partners (1986). Third Nairobi Water Supply project: Organisation, Management and Finance Study. Nairobi City Commission.

The Wilson Reservoir received water from Kabete reservoir and served the south C Wilson airport area, which was also served from the Hill tank located in Hurlingham area. Consumers in Westlands, Lavington, Thompson Estate, Woodley and Kibera areas were served directly from Kabete reservoirs. Figure 3.9 illustrates water provision in Nairobi in the year 2000¹⁶²

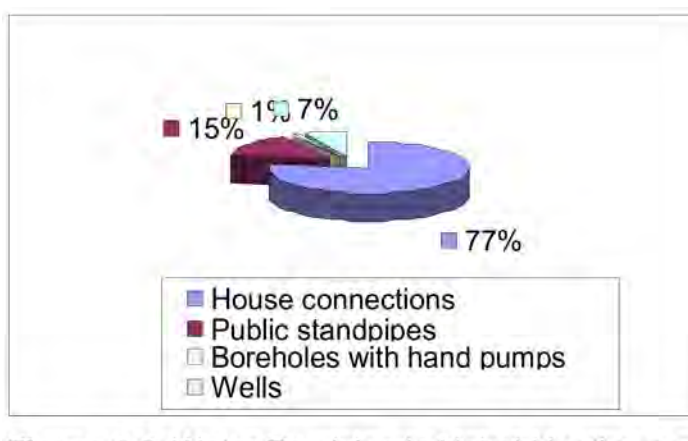

Figure 3.9: Water provision in Nairobi by the year 2000

The purpose of the Engineering Project was to help prepare a third-phase water supply investment project to meet the rapidly expanding water demands of Nairobi City up to the mid-1990s. The project also sought to strengthen the operations and financial management of the WSD to increase its efficiency and capacity to undertake the third phase, and to prepare recommendations for the long-term institutional development of an entity to manage Nairobi's water supply facilities. In addition, the project sought to review the finances of the non-water and sewerage activities of Nairobi City, and to initiate in-house training to improve financial and operational performance. Another project objective was to help prepare a long-term program for managing Nairobi's water resources on a regional basis¹⁶³.

Under these objectives the project gave the WSD a new opportunity to analyse its water resource situation and to prepare new plans for the future. In this exercise it became apparent that the level of UfW was high, at about 40 percent in 1987. Therefore, system rehabilitation was an urgent task, to stretch another capacity and make operations more efficient. By mid-1994, the rehabilitation program had re-

162 UNHABITAT (2000). Water Supply and Sanitation, Kenya. UNHABITAT, Nairobi.

163 The World Bank (1996). Kenya Evaluation Development of Housing, Water Supply and Sanitation in Nairobi. Report No. 15586 of April 25 1996. Operations Evaluation Department, world Bank

duced UfW to 25 percent, having a crucial impact on the growth of newly developed industrial and commercial activities in the eastern section of the city.

Institution-wise, the training program enhanced WSD's capacity to handle its responsibilities, significantly improving the implementation of WS III. The project-sponsored training program run by the Industrial Research and Consultancy Unit of the University of Nairobi provided invaluable feedback, improving operations by soliciting input from trainees. The turnover of trained and qualified staff was reduced, and quality of staff at all levels improved. The staff profile also improved; the supervisory staffs were more qualified, having received comprehensive internal training. Similarly, the number of lower-level staff reduced, because working methods improved and the system rationalized. The WSD became better equipped to run its operations and maintain its facilities. The ratio of staff per thousand connections, an indicator of operational efficiency, became 8.5, which places well among other water utilities throughout Africa¹⁶⁴.

Mombasa Water Supply

In 1898, Mombasa had a small water supply. The existing mode of water supply was by 'condensing', which was very expensive and worked only when the tide was high. The condensing plant had been brought from Britain to provide water during shortages Mombasa Island at start of the construction of the Uganda Railway. The British East Africa Protectorate had a condensing plant for the whites while the locals got water that was blackish from wells. At this time Mr. Smith, sought licence to form a company with the object of furnishing a supply of water to Mombasa.

The lands where the company structures were to stand on were to be leased to for a 99-year period¹⁶⁵. Subsequent reports on the question of water supply for Mombasa from 1899 show that the private developer did not succeed.

The earlier water supply in this region depended heavily on rainwater harvesting for a long period owing to the scarcity of freshwater. Groundwater was also a major source of water for a long time even though most of the areas were blackish usually fetched and conveyed by servants on their heads or shoulders (figure 3.10). Before 1920 surface waters were mostly harnessed using furrows. Mombasa town was the first to obtain an organised supply that was commissioned in 1916. Most of the other supplies which were developed soon after 1895 belonged to the Uganda Railway for their steam locomotives. The following is a discussion of the cases within the region.

164 The World Bank (1996). Kenya Evaluation Development of Housing, Water Supply and Sanitation in Nairobi. Report No. 15586 of April 25 1996. Operations Evaluation Department, world Bank.

165 British East African Protectorate (1898) Sub-Commissioner office, Ref No. PC/CP/1/1/124, Folio No.224, Kenya National Archives, Nairobi, Kenya.

In 1899 and 1900 information was gathered in connection to a water supply for Mombasa and a proposal of scheme was put in place. Once again in 1906, the Commissioner sought information on population that was expected to pay for water, probable amount of water required for shipping and the rates that could be reasonably charged, nullifying all similar information collected in 1899 and 1900 as out of date. The Governor (formerly Commissioner) further instructed the Secretary in 1908 to approach the Provincial Commissioner to form a committee for the purpose of reporting on the necessity of providing Mombasa with a potable water supply and preside over the meetings of the committee. Officials of the committee were; the Chief of Customs, the Medical Officer of Health, the Superintendent of Inland Revenue and conservancy. Messrs Turnbull and Anderson were selected as the unofficial members of the committee¹⁶⁶.

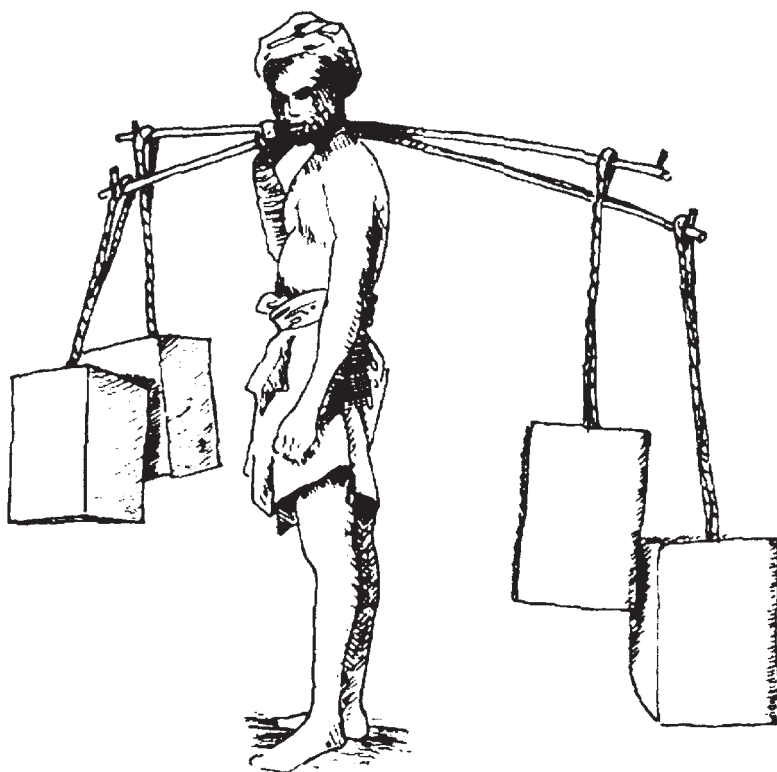

Figure 3.10: Mombasa water carrier 1910¹⁶⁷

166 Sadler J. H (1906). Letter from the Governor. Kenya National Archives, PC/Coast/1/14/103. 1906.

167 Rodwell E (1985). *The Old Town of Mombasa: A Historical Guide*. The Friends of Fort Jesus, Mombasa, Kenya.

The first piped water supply in Mombasa was put in place between 1911 and 1914 from the springs. The survey was carried out in 1911, and construction started in 1912. From the headworks to the Mwachi River crossing at mile 17, a line was cleared to a width of 61 metres; the work included cutting and the extraction and removal of the stumps. Total amount of excavation of 14260 cubic metres was done at 0.6 metres and 0.9 metres. An unmetalled road 26 kilometers along was constructed from Mteza jetty to the headworks at Marere.

When the work started it was estimated that it would require 1500 men employed continuously to complete the work in 2 years. However, the average number of workers was 380 inclusive of sick men. The works were being retarded by lack of labour¹⁶⁸

The construction work stated in March 1912 after the survey had been completed in January the same year. When the work was started, it was estimated that it would take 1,500 men employed continuously to complete the work in two years. Two years down the line, only 380 men had been employed. The work was retarded solely on account of lack of native labour to fill the deficit to arrive at the originally required number¹⁶⁹.

In 1912, plans were underway to install a ten-inch main proposed to take water down from Simba Hills and terminate at a point near Changamwe station. Approximately, seven acres (2.833ha) were required¹⁷⁰. Consequently, in 1913, the governor issued a notice under guidance from land acquisition act, 1894 that the government required the said land for public purposes¹⁷¹. In June 1913, the collector paid 2530 Rupees for the land in question under the regulations provided by the Land Acquisition Act, 1894¹⁷².

The rain water harvesting continued until 1916 when the Mombasa water supply was commissioned having started in 1911¹⁷³. The scheme was operated by the Director of Public Works until 1958 when the Mombasa Municipal Board was formed under Mombasa Pipeline Board Ordinance No. 19 of 1957 to further develop and undertake the bulk supply while retailing was undertaken by various

168 British East Africa Protectorate (1912-1914) Mombasa Water Scheme, Ref: PC/Coast/1/11/130. Folio 38, Kenya National Archives, Nairobi, Kenya.

169 Acting Resident Engineer, Mombasa water Supply (1913). Mombasa Water Works: Special Progress Report on Work up to 31st July 1913. Kenya National Archives, PC/Coast/1/11/130, REF: A/336 15th August 1913.

170 Director of Public Works (1912). Mombasa Water Supply: Acquisition of Land for the Service Reservoir. Kenya National Archives, PC/Coast/1/11/130, Ref: 27/36. 15th November 1912.

171 Governor (1913). Land Acquisition Act, 1894. Kenya National Archives, PC/Coast/1/11/130. 1913.

172 Collector (1913). Acquisition of land near Changamwe Station, Kenya National Archives, PC/Coast/1/11/130. 7th June 1913.

173 British East Africa Protectorate (1912-1914) Mombasa Water Scheme, ref; PC/Coast/1/11/130. Folio 38, Kenya National Archives, Nairobi, Kenya.

undertakers within the precincts of the municipality. The Board appointed the Ministry of Works as operating agent¹⁷⁴.

By 1925, there were 653 water connections in use and 25 kiosks for sale of water in Mombasa. The average daily consumption was approximately 2.2million litres¹⁷⁵. The amount of water consumed in 1930 was 1.167million litres as compared to 1.04million litres in 1929. The supply was increased when the new line was brought into use at mile 10 on February 1930¹⁷⁶.

Water from Mzima Springs Project started flowing to the taps of Mombasa consumers on May 23rd 1956. The water was being pumped to Changamwe reservoirs at Mazeras for chlorination before being gravitated to consumer lines. At the time when the project was commissioned, it was described as the biggest project ever undertaken in water supply in Kenya. The project was also delayed for about a year because of the insistence that all materials be sourced from England whether already manufactured or yet to be manufactured¹⁷⁷.

The main urban areas of Mombasa were the West Mainland and Mombasa Island. West Mainland was served by a ring main connected to twin pipelines linking Mazeras reservoirs and Changamwe reservoirs. Mombasa Island was supplied from Changamwe reservoirs by way of twin trunk mains running across Makupa Causeway¹⁷⁸.

Bulk water supply system was expected to serve the people of coast province with water. By 1972, bulk water supplies in Mombasa were owned by the Mombasa Pipeline Boards. The supplies were obtained from two main sources; Mzima springs in Tsavo West National Park and Marere springs in Simba Hills, and two minor sources, the Tiwi boreholes and Baricho intake. A look into the population projection indicates an enormous task that the Mombasa pipeline boards were entitled. A look at the sources of Mombasa water supply is illustrated in figure 3.11¹⁷⁹.

174 Mombasa Pipeline Board (1960) Report and accounts for Financial Year ending 30th June, 1959, Government Printer, Nairobi.

175 District Commissioner (1926). Annual Report, 1925, Mombasa District. Kenya National Archives, DC/MSA/1/1/3. 1926.

176 District Commissioner, Mombasa (1924). Annual Report: 1930, Mombasa. Kenya National Archives, DC/MSA/1/1/4. 31 District.

177 Colony and Protectorate of Kenya (1951-59) Water supplies for Mombasa District and Mzima springs project. Kenya National Archives, Ref. No. CA/17/99, Folio No.93 Nairobi, Kenya.

178 Mombasa Pipeline Board (1972). Mombasa Water Supply: An Investigation into an Additional Source to Provide the Necessary Immediate Augmentation of Mombasa Pipeline Board Supplies-Draft Supplementary Report on Alternative Schemes for Supplying Water to Mombasa and the North Coast. Nairobi, Kenya.

179 Hunn G (1983). Progress Report About water Projects included in the Minor Urban Water Supply Programme. NORAD –Coordinator/MOWD. Nairobi Ref: WD/1/2/5. 10th June 1983.

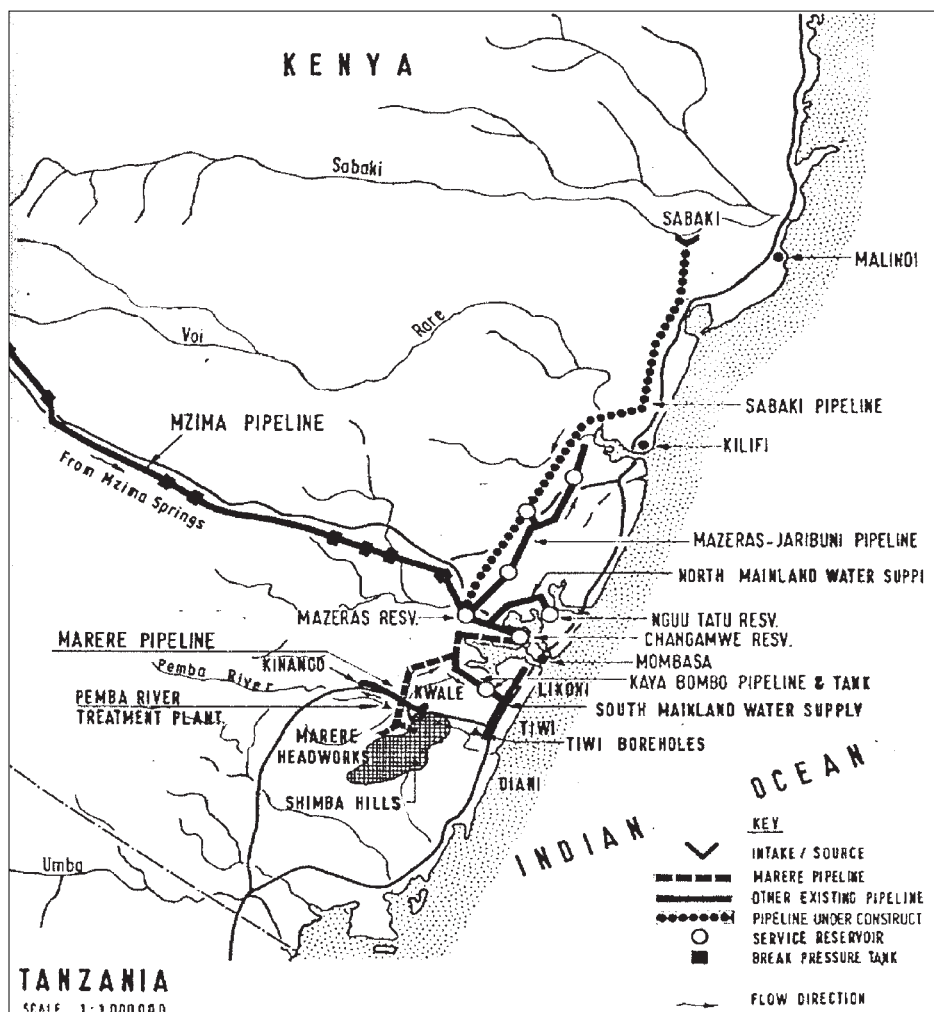

Figure 3.11: Sources of Mombasa Water Supply

Water from Mzima Springs was fed to Mombasa by gravity through pre-stressed concrete pipeline which was approximately 219km long stressed pipes ranging in diameter of 20 to 30 inches. The pipeline delivered water to service reservoirs with a total storage capacity of 80,000 litres at Mazeras. From Mazeras reservoirs, water supply was conveyed through twin 21 inches diameter pipelines to the service reservoirs at Changamwe. Two connections to these twin pipelines conveyed water to outlying areas¹⁸⁰. The supplies covered an area approximately 2000km² with an

¹⁸⁰ Mombasa Pipeline Board (1972). Mombasa Water Supply: An Investigation into an Additional Source to Provide the Necessary Immediate Augmentation of Mombasa Pipeline Board Supplies-Draft Supplementary Report on Alternative Schemes for Supplying Water to Mombasa and the North Coast. Nairobi, Kenya.

estimated population of 1.7 million persons. More than 90 % of this population resided in urban dwellings. A projection of population growth indicated a 2.5 million people by 2020¹⁸¹. Table 3.7 analyses the population data and projections for the Coast Province.

Table 3.7: Coast Province – past population data and projections to 2035

Year	Low	Medium	High
	Linear	Geometric	Exponential
1969	745,877	745,877	745,877
1979	1,108,974	1,108,974	1,108,974
1989	1,653,429	1,653,429	1,653,429
1999	2,415,917	2,415,917	2,415,917
2009	3,316,346	3,316,346	3,316,346
2015	3,792,231	4,010,574	4,293,595
2020	4,207,960	4,698,892	5,182,370
2025	4,623,689	5,505,343	6,255,121
2030	5,039,419	6,450,201	7,549,931
2035	5,455,148	7,557,222	9,112,768

Water from Marere Springs was conveyed through a cement lined steel pipeline approximately 41km long. This pipeline discharged in to Changamwe service reservoirs which had a total service storage capacity of 29,600m³. A connection from Marere pipeline delivered water to 1,100m³ capacity service reservoirs at Kaya Bombo. From Kaya Bombo, water was distributed to various parts of the coastal area south of Mombasa¹⁸². The Marere and Mzima systems collected water with surface intakes from the springs into the pipeline for transmission to Mombasa and other towns. Figure 3.12 illustrates the major water supplies in Mombasa¹⁸³

181 Coast Water Services Board (2012). Water Supply Master Plan for Coastal Region; Water Demand and Supply Assessment Report.

182 Mombasa Pipeline Board (1972). Mombasa Water Supply: An Investigation into an Additional Source to Provide the Necessary Immediate Augmentation of Mombasa Pipeline Board Supplies-Draft Supplementary Report on Alternative Schemes for Supplying Water to Mombasa and the North Coast. Nairobi, Kenya.

183 Government of Kenya (2002). Review of Options for Private Sector Participation in the Provision of Water Supply and Sewerage Services in Mombasa and Coastal Region (Kenya). Pricewaterhouse-Coopers. 2002.

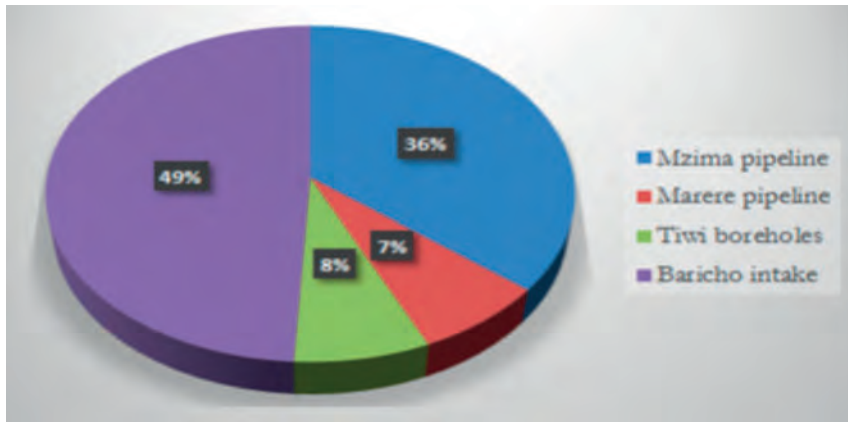

Figure 3.12: Mombasa Water Supply in 1981

Mazeras, Mariakani, and Rabai Water Supply: These supplies were constructed in 1948. The scheme drew water from Msapuni borehole through a rising main. This borehole was equipped and water was being pumped to the Benya Gundo tank site. The water then gravitated to Mazeras, Mariakani and to Rabai tank sites.

However, there was a petition regarding supply to the district of Rabai by the citizens of Rabai to the provincial commissioner dated 24th march 1919. The petition indicated that there was only one water supply to the district with a reservoir called Kikobweni. The supply was inadequate and for at least seven months out of twelve the people were compelled to use water which was more or less befouled with noxious mud. This happened despite the nearness of the government water supply for the Railway at Mazeras, the petitioners went ahead to request a supply tapped from this and delivered to the district as the Railway station at Mazeras was only five kilometres away. It appears that the provincial commissioner sought advice from the Public Works department in Nairobi¹⁸⁴.

In a reply by the said department to the commissioner on the petition dated 22nd April 1919, the Director of Public Works pointed out that it was impracticable to obtain a water supply for the inhabitants of Rabai from the Mombasa Main. The Director proceeded to note that even if the Railway pumping installation were able to pump the additional demand to meet Rabai requirements, a second pumping installation would be required at Mazeras to force the supply to Rabai. The cost would, therefore, be excessive and beyond practical consideration. In exploring another possibility, the director talked of a pumping supply from the Mwachi. He

184 British East Africa Protectorate (1919). Rabai water supply, Kenya National Archives, Ref. PC/Coast/1/13/43, folio Nos. 1-4, Nairobi, Kenya.

said that the installation that was in use at this point used by the Uganda Railway had been removed. The cost of installing a pumping supply at this point was more than the expected revenue therefore the director found it unjustifiable on the above grounds. He also indicated that water samples from Mwachi were previously found to be unfavourable and had to be taken to the Government analyst and bacteriologist¹⁸⁵.

Kisumu Water Supply

Kisumu, which was known as port Florence in 1901 was the terminus of the Uganda Railway on the Victoria Nyanza. The town is about 3,800ft above sea level and is built on a low saddle-backed hill on the northeast side of Ugowe bay. The daily temperature as reported by Williams in 1907 ranged between 80° F and 90° F while the average rainfall was recorded as 51 inches with tropical climate. The most important buildings in Kisumu were the railway station, customs house, railway workshops, collector's office, magistrate's court, treasury, hospital, PWD office and yard, market, Gaol and police station. To complement the above were the railway bungalows, the Indian bazaar and the native quarter¹⁸⁶.

The development of water supply in Kisumu coincided with the reaching of the Uganda Railway in Port Florence (Kisumu) in 1901. The Railway developed its supply in 1901. The supply consisted of six-inch double ram, steam force pump in duplicate with locomotive boilers in duplicate. The suction operated through 390 feet of 4 inch galvanized iron pipe. The surface intake was fixed some 98 feet from the lake. The amount of water from the source was approximately 80,000 gallons of which 20,000 gallons were used to fill the Railway tanks¹⁸⁷.

This supply remained the major supply until 1926¹⁸⁸. The water was pumped up to a tank having a holding capacity of 100 m³ and from the tank; it was distributed by means of pipes and hydrants. This water was not portable for Europeans, was only available in daytime and it was turned off at night. The water was used in town generally and also by the railway department for engines.

By 1921, the Marine Superintendent, Kisumu observed that:

‘In my opinion the whole plant supplying water to Kisumu is out of date and totally inadequate for the present needs. It would be quite sufficient for the original

185 British East Africa Protectorate (1919). Rabai Water Supply, Kenya National Archives, Ref. PC/Coast/1/13/43, folio Nos. 1-4, Nairobi, Kenya.

186 Williams G.B (1907). Report on the Sanitation of Nairobi and Report on the Townships of Naivasha, Nakuru, and Kisumu. Kenya National Archives, GP, 363.7.BRI. 1907.

187 Williams G.B (1907). Report on the Sanitation of Nairobi and Report on the Townships of Naivasha, Nakuru, and Kisumu. Kenya National Archives, GP, 363.7.BRI. 1907.

188 Colony and protectorate of Kenya (1913-1959) Kisumu water supply, BY/35/2 Kenya National Archives, Nairobi, Kenya.

purpose for which it was installed i.e. to supply water for the railway tanks and railway staff quarters, were it kept for that purpose entirely¹⁸⁹.

Kibos River scheme was developed in 1926 and in 1928, there were intentions to metre and charge all water supplied to employees of the government including natives. This was meant to check the colossal waste emanating from constant supply. The PC noted suggested of a system whereby the pipeline leading to a tank was filled with water but from which water could not be drawn unless a pump is used. To control wastage, only required water would be pumped¹⁹⁰.

In 1928 an additional sedimentation tank was constructed and the pressure filters increased from three to six in number as the consumption of water was greater than anticipated (i.e. about 818 m³ per day). A small extension of the head works enabled small clear water stream to be captured in 1930, the clear water reduced the requirement of chemical for purification works.

By mid 1930s, the Kajulu Water Works were taxed to its maximum capacity, and investigations were carried out in 1936 with a view to augmenting the supply of water. In 1938 an additional 455 m³ reinforced concrete reservoir to augment the storage of Kisumu water supply was constructed.

In 1945 there was a drought and influx of large numbers of military personnel that led to the necessity to install pumping plant at the lake so as to augment the supply from the Kibos River. The alternative was either to dam Kibos River to form a large reservoir or pumped water from the lake or a combination of the two projects undertaken.

For the first time in the town's history, the water installation on the Kibos River failed. Fortunately pumps had been installed on the lakeshore to supplement the supply to the headquarters, and by increasing the number of pumps; it was possible to avert serious inconveniences to the public. Eventually, a consulting engineer recommended that the delivery from the Kibos River be supplemented by the supplies delivered from the lake. The consulting engineer submitted two reports on water supply during the year and outlined its scheme to pump water from the lake.

In the meantime the Kisumu Municipality by-Laws of 1945 were enacted and came into force. The purpose of these By-Laws was to transfer from the Public Works Department to the Kisumu Municipal Board the powers vested in the water authority by the Township (Water Works) Rules. Kisumu water supply was handed over to the Kisumu municipal board on 1 July 1945. The scheme for pumping water

189 Colony and protectorate of Kenya (1913-1959) Kisumu water supply, BY/35/2 Kenya National Archives, Nairobi, Kenya.

190 Provincial Commissioner (1928). Letter to District Commissioner Explaining Details of Water Conservation. Kenya National Archives Ref: 1217/9/8/ 10th April 1928.

from Lake Victoria as prepared by the consulting engineer to the municipality was adopted by the Municipal Board.

In order to supplement the town's supply when needed, a small pumping plant, installed by the Royal Air Force near the lake shore was purchased by the Municipal Board as a stand-by.

The change over from gravity supply from the escarpment to the lake supply made progress, but it was increasingly evident that every effort should be made to increase the supply of the scheme if the water supply to town was to be adequate. Preparation for additional water storage tanks (919 m³ water reservoir) was made. In 1961 work started on the laying of the new trunk main to the Nairobi Road and the Watsons Bank.

Other works were to supplement the above water supply system as described in the individual Location Zones in this Report. Nevertheless, it is important to mention recent studies relating to Kisumu Water Services.

Kisumu Structure Plan 1983-2013: This was prepared by the Physical Planning Department of Kisumu Municipal Council and Ministry of Local Government in 1983. It outlined the development scenario in Kisumu up to year 2013.

Nakuru Water Supply

The water supply as was obtained 9.5 miles (15 kilometres approximately) away from Njoro River where a small concrete dam had been built by the railway in 1901 to impound water. The water was channelled through a 2.5-inch pipe (GI) to Nakuru. About 33,000 gallons a day was made available in this way¹⁹¹.

Nakuru is one of the towns through which the Railway line passed. A railway station was constructed at Nakuru to serve as a terminus and for overseeing of the railway operations. As a result the Uganda Railway put in a water supply to serve the employees of the railway as well as for locomotive use. This water supply was derived from a dam on the Njoro River and piped down to the station at Nakuru. The water supply, which was untreated, served the township by 1910 it was in place and operating¹⁹².

At the station, water was delivered to four tanks elevated above 30 feet above ground and of capacity 58m³. This first set of tanks supplied the running shed with water. The overflow from the above tanks was directed to a second set of eight tanks with capacity 58 m³, which supplied the water cranes in the station. Overflow from the second set of tanks went to yet another set of tanks of capacity 727 litres which

191 Williams G.B (1907). Report on the Sanitation of Nairobi and Report on the Townships of Naivasha, Nakuru, and Kisumu. Kenya National Archives, GP, 363.7.BRI. 1907.

192 Williams G.B (1907). Report on the Sanitation of Nairobi and Report on the Townships of Naivasha, Nakuru, and Kisumu. Kenya National Archives, GP, 363.7.BRI. 1907.

formed the service tanks for town supply. The overflow from this tank was directed to a concrete tank below the station to be used for laundry. The locomotives are said to have had a demand of 45.4m³ while the inhabitants of the township used the rest, 23,000 gallons. Williams, in 1907 did not recommend the use of this water by the public without filtration and thus recommended a scheme involving tapping the Mereroni River¹⁹³.

In 1915 the Government through the Public Works Department completed the water supply system from the Mereroni River at a cost of KES. 258,220. It was connected up with that portion of the Existing supply, which fed the township, the old supply from Njoro being retained in the Railway workshops and station and settlement¹⁹⁴. The cost breakdown of the water supply project is given Table 3.8.

Table 3.8: Cost of Mereroni water supply for Nakuru

Item	Cost (KES)
Cost of work done by PWD	258, 220
Cost of Railway piping and Connection to Mereroni supply	49,660
Improvement additions put in by Railway subsequent to connection	43,044
Total	350,924

After putting up the water supply in 1915 its operation and maintenance seems to have been delegated to the Railway. This deduction is due to fact that the railway station started to collect the water charges for the supply immediately it went into operation¹⁹⁵. Table 3.9 shows the revenue collected from the water supply from 1915 to 1921.

Table 3.9: Revenue Collected from Nakuru water supply by the railway

Year	Revenue collected by Railways (KES)
1915	1,533.22
1916	4,225.22
1917	4,429.30
1918	8,734.02
1919	7,169.90
1920	7,818.78
1921	9,983.46
Total	43,893.90

193 Williams G.B (1907). Report on the Sanitation of Nairobi and Report on the Townships of Naivasha, Nakuru, and Kisumu. Kenya National Archives, GP, 363.7.BRI. 1907.

194 British East Africa Protectorate (1915). Water Supply Nakuru. Kenya National Archives, Ref: ACW/33/5, Nairobi, Kenya.

195 British East Africa Protectorate (1915). Water Supply Nakuru. Kenya National Archives, Ref: ACW/33/5, Nairobi, Kenya.

The water supply, which was put up by, the railway from the Njoro River was as said earlier not treated and hence presented with problems of pollution especially of organic contamination at the intake. This was chiefly caused by cattle watering at the intake. To alleviate the problem the intake was relocated to a position above the point of contamination and the cattle owners advised the fetch the water for watering their animals.

In 1913 a pipeline to convey water to Nakuru Township from Mereroni River was proposed. The pipeline was to be laid through Mr Costello's farm. This presented a unique problem, as Mr. Costello could not allow the work to proceed unless he was first compensated to tune of 300 pounds. The predicament was resolved by application of section 23 of the Crown Lands Ordinance of 1902, which allowed the Governor to enter freehold or leasehold land and lay pipes without compensation but making good all damages¹⁹⁶.

The World War I had it effects on a number of developments in the then colony of Kenya and water development was not an exception. During the construction of Nakuru water supply, which took place during the wartime, there was diversion of funds meant for the construction of the water supply to fund the war. Birch in 1915 states in his letter to the Chief Secretary that a sum of 1200 pounds had been retrenched for War purposes in the preceding financial year from the amount sanctioned in the estimates of about 5126 pounds for the Nakuru water supply. This situation had led to stalling of the works and over expenditure due to delay.

Under the railway management new connections were added in a haphazard way resulting in a state of affairs such that the railway could not supply reasonable demands for water nor could any further new connections be added, notwithstanding that the supply available suffice for a town of twice its population.

Mereroni Water Works: This was the first water works constructed in 1913 and expanded in 1962. The water treatment design capacity for this works was about 5,960 cubic metres per day. However, it treated 1000 cubic metre of water per day during dry season and 5,000 cubic metres during the wet seasons.

Malewa Water Works: The Malewa Water works was constructed in 1952 with a treatment capacity of 2500 cubic metre of water per day. By the year 2005, the water works treated between 1500 and 2000 cubic metres of water per day. The Malewa line was from Gilgil to Nakuru Town, a distance of 43 Km¹⁹⁷.

196 British East Africa Protectorate (1915). Water Supply Nakuru. Kenya National Archives, Ref: ACW/33/5, Nairobi, Kenya.

197 District Commissioner (1955). Annual Report- Nakuru District. Kenya National Archives. DC/ NRU/11/7. 1955.

Kabatini Boreholes: These were six boreholes on this site, located about 7 Km from the Municipality boundary. The first four were drilled between 1979 and 1980, while the other two were drilled between 1989 and 1990. These boreholes produced about 13000 and 15000 cubic metres of water per day. Only five boreholes were operational regularly, therefore production was normally below the design capacity. In 1997, an electrical power and lightning arrestors were installed.

Baharini Boreholes: There were four boreholes on this site. They were located near the North shores of Lake Nakuru. They were drilled between 1969 and 1970. These boreholes produce about 4300 and 6000 cubic metres of water per day. In 1997, an electrical power and lightning arrestors were installed.

Nairobi Road Boreholes: These boreholes were situated along Nairobi – Nakuru road. Two boreholes on this site were drilled in 1952 and the third one in 1959. They had a combined yield of between 4000 and 5000 cubic metres of water per day. They were rehabilitated in 1997 after they were out of operation since 1993.

Water distribution: Water was distributed to consumers from six reservoirs through a system that covered a total of about 356 Kilometres. This distance for pipe network ranged between 2” to 24” diameter. Pipes used were made of asbestos cement, galvanized iron, cast iron and PVC.

Nakuru East Reservoir was situated on Nelan Farm and had a capacity of 4000 cubic metres per day. It served Lanet, Free Area, Naka Estate and a portion of Mwariki Estate farm.

Playing Field Reservoir (Nairobi Road) was located along the Nakuru-Nairobi road at its junction with Crater Climb. Its storage capacity was 3400 cubic metres per day. This reservoir received water from Baharini and Nairobi Road boreholes. It also received water from Malewa and National Water Conservation and Pipeline Corporation supply lines. This reservoir served the southern parts of town, which included Maasai Avenue, Shah Estate, and some sections of 58, all estates below the Municipal depot up to Mwariki South Estate, Langalanga, Racetrack and some parts of Freehold Estates.

There were two reservoirs at Mereroni Treatment Works with a storage capacity of 4200 cubic metres per day. Water from Kabatini boreholes and Mereroni River was stored in these reservoirs. Water from these reservoirs served the Central Business District, Industrial Area, Parts of Freehold Estate, Shaabab, Koinange Estate, Milimani and some parts of Section 58. Water from one of these reservoirs also flowed to Prison Reservoir.

Milimani Reservoir (High Level Zone Reservoir) reservoir was situated at forest Department on the slopes of Menengai Crater. Water was pumped from the

reservoir at the Mereroni Treatment Works to this reservoir. This reservoir had a capacity of 1000 cubic metres per day. Water from this reservoir served the whole of Milimani Estate.

Prison Road Reservoir had a capacity of 4500 cubic metres of water per day and received water from Mereroni Treatment Works by Gravity. Water from this reservoir served Industrial area, Shaabab Estate, Donsonvill Estate, Menengai Estate and Japanese flats. Water from this reservoir was also pumped to the G.K. Prison and the surrounding estates. Nakuru West Reservoir was located on the compound of National Water Conservation and Pipeline Corporation, which is near Union Carbide factory¹⁹⁸.

Nakuru prison: The Nakuru prison was in existence before 1936. However, the barbed wire enclosure had no water laid on for 800 prisoners, which gave rise to many difficulties. Due to the high number of prisoners, the dust was very bad and difficult to control. The medical officer recommended provision of water and shower baths and a short drain leading to the prisons garden. To combat dust, he recommended putting tarmac of all prison courtyards¹⁹⁹. When the site for the new Nakuru prison got ready in 1962. Priority was given to erection of a 9 m³ water storage tank to the northern side of the prison due to limited fund. It was proposed that as the funds availed, kitchen should follow suit.

Eldoret Water Supply

The town of Eldoret has a remarkable history as was settled by the first European settler around 1900. A large trek of Afrikaans of South African came to Eldoret in 1908 and shortly afterwards British settlers arrived. The then Governor Sir Percy Girouard, then decided to make Eldoret the administrative centre for both the Uasin Gishu and Trans Nzoia districts, at a great gathering of farmers in “Eldare” a Maasai name for stony river referring to the Sosiani River (Doria, undated). Eldoret as it came to be known later on was officially pronounced township in 1912, this resulted in initiation of quick development in Eldoret, including administrative offices, official houses, the post office, a bank, business premises etc.²⁰⁰.

The year 1924 saw the arrival of Sir Robert Coryndon, the Governor of the colony of Kenya, on the first train to Eldoret. This event opened up new era for the town, with cheap and improved transport. Before 1928 the town did not have

198 Provincial Medical Officer (1953). Nakuru Prison. Kenya National Archives, BY/6/322, Ref: 2.1/336 Vol. II. 26th February 1953

199 Provincial Medical Officer (1953). Nakuru Prison. Kenya National Archives, BY/6/322, Ref: 2.1/336 Vol. II. 26th February 1953.

200 Town Clerk (1963). Municipality Ordinance [Cap.136]. Kenya National Archives, DC/UG/2/3/33, Ref: 240104/11. 1963.

piped water supply. Mrs. Eddy made a business to use ox cart to ferry water from the Sosiani River for sale to the township residents.

The first water supply was installed in 1928 depriving Mrs Eddy of her prime business. The water was piped from the Sosiani River by the railways, from about 13 kilometres away and was later taken over by the Municipal Board. The first rates were collected in the same year and the first budget was helped by a Government grant of 3,000 pounds, which made it possible to make some improvements to the water supply. In its first inaugural steps the water supply was aided by an able and efficient man in the form of Col. G. East King who was the Town Clerk and Clerk to the council as he had, had experience of this work in Nairobi²⁰¹.

The actual springs and streams which together formed Eldoret water supply lay in the Grogon Concession outside Elgeyo reserve. The Africans were disgusting and were unable utilize water supplies in the required manner, as the district commissioner, Elgeyo Marakwet indicated “this place is infested by Kikuyu Squatters and tribal policeman and watchmen have to be employed to stop any interference with the source²⁰²”. Native employees damaged the gravity main leading to severe and publicized imprisonment²⁰³.

In 1962, two river dam was installed in 1962, costing over 400,000 pounds augmenting a combined water supply and main drainage scheme for Eldoret. This led to a considerable expansion²⁰⁴.

Augmentation of water supply: in March 1958, it was recommended that with the inception of new scheme, the price of water be raised by 50 cents to 4 shilling per 1,000 gallons. This price compared favourably with charges made in most other parts of the colony. The total water consumption for 1958 was 140 million gallons, which yielded 22,040 pounds. In 1959, the consultants’ proposals envisaged an expenditure of 198,000 pounds on the augmentation scheme. Of this amount, 30,000 pounds could be met from the water undertaking reserves and 168,000 pounds from a loan. The projection for 1961 showed a consumption of 177 million gallons per annum²⁰⁵.

The council’s application to the Water Apportionment Board for the extraction of 800,000 gallons of water per day from Sosiani River drew objection from the East

201 Town Clerk (1963). Municipality Ordinance [Cap.136]. Kenya National Archives, DC/UG/2/3/33, Ref: 240104/11. 1963.

202 District Commissioner (1930). Eldoret Water Supply. Kenya National Archives DC/Tamb/1/12 Ref: PW/8/2/8, 8th October 1930.

203 Harris H.R (1932). Eldoret Water Supply. Kenya National Archives. DC/Tamb/1/12, Ref: 1649/7/2/1/1. 26th August 1932.

204 Town Clerk (1963). Municipality Ordinance [Cap.136]. Kenya National Archives, DC/UG/2/3/33, Ref: 240104/11. 1963.

205 Municipal Engineer (1959). Eldoret Main Drainage. Kenya National Archives, BY/4/84, Ref: 23/1/24. 7th April 1959.

African Railways and Harbours, East Africa Power and Lighting Co. and Uasin Gishu County Council. Two of the objections were based on lack of adequate provision for storage. The council contemplated seeking intervention of the minister²⁰⁶. The Water Apportionment Board upheld the objects and this led to further modification of by the council²⁰⁷.

By 1998, the Eldoret municipal council was the undertaker for the Eldoret water supply with a source from Sosiani River. Raw water was supplied through gravity and pumping to fully conventional treatment plant. The supply covered an area of 150km² serving approximately 127,500 consumers in an area with approximately 250,000 people²⁰⁸.

Nyeri Water Supply

Nyeri town began as a result of military activity. A trading caravan had been ambushed, leading to the sending of one military expedition from Naivasha, through the Nyandarua mountains, commanded by colonel Meinertzhagen, and another led by Ms Barlow, Hinde and Hemsted up from Fort Hall (now Murang'a). Meinertzhagen reached the base of Nyeri hill on 4th December 1902 and found Hinde camped there. On 6th December they moved to the present location of the District and provincial administrative offices where they built a fort. This location was considered better placed for defence and obtaining provisions²⁰⁹.

The fort was surrounded by a deep defensive ditch (known as Mukaro) leading to the present name of the central area of Nyeri town. The principal military function lasted up to 1905, but in the interim, Asian traders had been attracted to set up business within the area of relative safety near the fort, and missionaries also moved in at the request of the military officials.

The Catholic Missionaries of the Consolata Society for foreign missions of Turin, Italy started a mission centre at Tetu, 5 km from the fort, in March 1903, and another at Mathari later that year. Church of Scotland Missionaries had established a small centre earlier, in 1902, and eventually opened a full scale mission at Tumutumu (1909) rather than at Nyeri.

On 15th May 1911, Nyeri was gazetted as a township, comprising an area of one and half kilometre radius from the flag post of what is now the District Com-

206 Eldoret Municipal Council (1959). Works Committee. Municipal Engineers Report-April 1959. Kenya National Archives, BY/4/84. April 1959.

207 Eldoret Municipal Council (1959). Municipal Engineers Annual Report-1959. Kenya National Archives, BY/4/84. 1959.

208 Nippon Koei Co Ltd and Kokusai Kogyo co. Ltd (1998). The Aftercare Study on The National Water Master plan in the Republic of Kenya. Final report, Data Book. JAICA and the Ministry of Water Resources. November 1988.

209 Ministry of Local Government (1997) Nyeri Water Supply; Feasibility study report, Nairobi, Kenya.

missioner's office. The following year the town became the administrative capital of Nyeri district, and also headquarters of the Kenya province of the East African Protectorate. In 1913 the 'old town' borders were established, remaining Nyeri town's borders for the next sixty years.

In 1927, the railway reached Kiganjo, which had been chosen as the Nyeri railway station, to reach closer to the settler farmlands which had developed to the North following the 1912 relocation of the original Maasai inhabitants to areas around Narok.

After some boundary changes in the Kenya Colony, Nyeri town became the capital of Kikuyu province in 1924. In 1933, further changes occurred and Nyeri was made the capital of the then Central province which included Nanyuki and Meru to the North, Nairobi to the south and the Machakos/Kitui to the east.

Nyeri town obtained the status of a Municipality in May 1971, when the first mayor was elected. The elevation in status was accompanied by a ten-fold increase in the town area from the area defined by the 1913 survey and distribution of plots.

Nyeri water supply dates back to the 1930s, based upon pumped abstraction from the Chania River, at a point below the Outspan Hotel, and the Treatment Works located in the area that is now the site of the District Water Office.

The Chania intake is still existing and operational, but the rising mains now in use were recently laid (1972), delivering water to the Treatment Works currently operational. The intake pumpsets were installed between 1972 and 1979.

At the old treatment works there is no evidence of the treatment facilities which were in use. The five clear water tanks are still there, although they had not been in use for a long time. There are five ground level tanks, four of them of 135 m³ capacity each, commissioned between 1946 and 1950, and one of 450 m³ capacity, put in use in 1956.

In 1959 a new intake was constructed at Ihwa, about 6 kms from Kamakwa, with an Asbestos Cement pipe work raw water gravity main, and treatment at a new site at higher elevation but still within Kamakwa being constructed, about 250m from the old site.

These original treatment units were augmented in 1968 by a parallel stream of units and by yet another treatment stream in 1986. The construction of new works in 1986 was accompanied by the installation of a second gravity main from Ihwa.

By 1980, Nyeri got its water from Chania River. It was abstracted from two sources, one from the 1957 scheme and another through a stilling well intake from Chania River roughly 700m from the treatment works. Three electric pumps delivered water to the treatment works where pre-treatment chemical dosing of alum and soda ash together with post treatment dosing of chlorine and soda ash was

undertaken. A total of 3300m³ per day was produced. The works often exceeded its design capacity by more than 40% and no longer met demands. The ministry of Water Development proposed making extensions through new raw water pipe work from the existing gravity intakes. The proposed system was supposed to use water from Chania River which was capable of run-of-river yields up to 2600m³ per day without detriment to other users. All new works were designed with initial capacity of 15000m³ per day rising to 26000m³ per day which was the estimated demand for Nyeri by the year 2000²¹⁰.

In July 1995, Nyeri Municipal Council formed and started to operate an independent water and sewerage department (WSD) to carry out the activities of providing water supply and sanitation services. Prior to this period, the department existed as a water and sewerage section in the Municipal Engineer's department. The main objective of operating an independent Water and Sewerage department was to ensure that these services were on a self-sustaining basis while achieving a high level of efficiency in provision of water and sewerage services. The independent department water and sewerage department had the following features:

- The department had an independent management team, which was headed by the General Manager. The General Manager was assisted by two assistant general managers, Commercial and Technical Manager, who headed Commercial and Technical divisions of the department respectively.
- The department was responsible of preparing its own independent plans and the consequent budgets and programs to enable it perform its activities of providing water supply and sanitation services effectively.
- The General Manager was principal signatory of an independent operated water and sewerage bank account that controlled the revenue generated from water supply and sewerage services.

These features were consistent with the World Bank (1994) definition of commercialisation of water supplies and sanitation services. The World Bank Report defined commercialisation to be characterised by the institution having clear and coherent goals focused on delivering services, having autonomous management and enjoying financial independence. Therefore, commercialisation process of water and sewerage services in Nyeri Town could distinctively be said to have started when the council formed an independent water and sewerage departments. Commercialisation had

210 Waweru and Associates and Rofe Kennard and Lapworth Terrapian Kenya (1980). Third Urban Housing Project Interim Report No. 1 Volume A: The Towns. Republic of Kenya, Ministry of Housing and Urban Development.

adopted Option A of alternative management options of water and sanitation services where the infrastructure was public owned and public operated.

This was the first management option in commercialisation, where the infrastructure and management of the utilities remained with the central or local government but enjoyed both managerial and financial autonomy.

Need for commercialisation: The move to commercialize water supply and sanitation services was justified by the following:

- a) Poor management of both water and sanitation systems and services to the public.
- b) Frequent transfer of funds from water sales to unrelated expenditure at the expense of water services leading in most cases to deferred maintenance of facilities, and thereby occasioning rapid deterioration of infrastructure.
- c) Lack of provision of renewal funds and loan payments.
- d) Application of tariffs that did not cover full cost of providing water and sewerage services.
- e) Higher water losses leading to high and unacceptable levels of unaccounted for water.
- f) Late billing and non-payment of bills especially by the Government Department which affected efficiency of revenue collection and operation and maintenance of infrastructure.
- g) Overstaffing with unskilled personnel resulting to high staff budget in relation to other expenses.

Other development: Despite the realisation of the key issues that affected the provision of water supply and sanitation services, the independent water and sewerage department achieved minimal improvement in performance. The bureaucracy involved in the Central Government and Local Authority continued to hinder the effectiveness of the department. For example, frequent transfer of funds from water and sewerage bank account to meet unrelated expenditure at an expense of these services, overstaffing with unskilled personnel and high level of unaccounted for water among others. Nevertheless, the department succeeded in achieving the following:

- Training of staff especially in financial management courses with the help of GTZ which partly sponsored the training. A total of 12 courses were trained.
- Sensitizing both the civic leader and other chief officers of the council on the need to have self-sustaining water supply and sanitation services.

- Computerizing billing, payroll and a few management information reports like production of billing summaries and disconnection list of customers who have defaulted to pay bill on time.
- Increasing water supply, which reduced water supply deficit in the town.

Minor Urban and Institutional Water Supplies

This subchapter discusses all other urban centres water supply apart from the specified major urban water supplies in the previous subchapter. A programme known as Minor Urban Water Supply Programme was a major boost for water supply in small urban centres. A regional based classification into provinces has been adapted for ease of reference; these provinces include Coast, Rift Valley, Nyanza, Western, North Eastern, Eastern and Central provinces.

The minor urban water supply programme objective was to provide water supply and sewerage/sanitation facilities for minor urban centres and growth centres throughout Kenya. It received its first funding from Norwegian government through NORAD in 1974. The Ministry of Water Development administered and implemented the programme on behalf of the government of Kenya. The follow-up responsibility on the Norwegian side was delegated to NORAD's Resident Representative in Kenya²¹¹. Table 3.10 illustrates minor urban water supply programme, the schemes completed, under construction and those being designed against the cost by 1983.

Table 3.10: Status of Minor Urban Water Supply Programme by 1983

Status of the scheme	Number of schemes	Estimated cost (KES x 10 ³)	Expenditure (KES 10 ³)	Design population served (x 10 ³)
Completed	17	115,710	115,267	224
Under construction	11	248,900	122,017	184
Under design	11	750,800	15,255	595
Total	39	1,115,410	252,539	1,003

The second agreement was signed in 1984 committing the KES 170million in addition to the KES 200 million granted since 1973. In addition, technical assistance to MoWD during the period 1973-1988 amounted to approximately KES 150 million. By the end of 1984, the programmes water supply component had consumed KES 424 million. Some 25 schemes had been completed and it was expected

²¹¹ HIFAB International (1988). Report of Appraisal Mission: Minor Urban Water Supply Programme 1988-1992, Proposed by the Ministry of Water Development, Kenya in March 1988. Ministry of Development Cooperation (NORAD) April 1988.

that by 1988 NORAD contribution to MUWSP would be KES 520 million and a total of 620 million when Kenyan cash contribution was included. By 1988, 34 schemes had been funded in total or in large part. It should be noted that schemes are concentrated in two areas, the central part of the country north of Nairobi and western part of the country along the Uganda boundary. Scattered schemes are also found in the far north in the Turkana area, the North Eastern and East Coast area (Wajir, Garissa, Malindi, etc.).

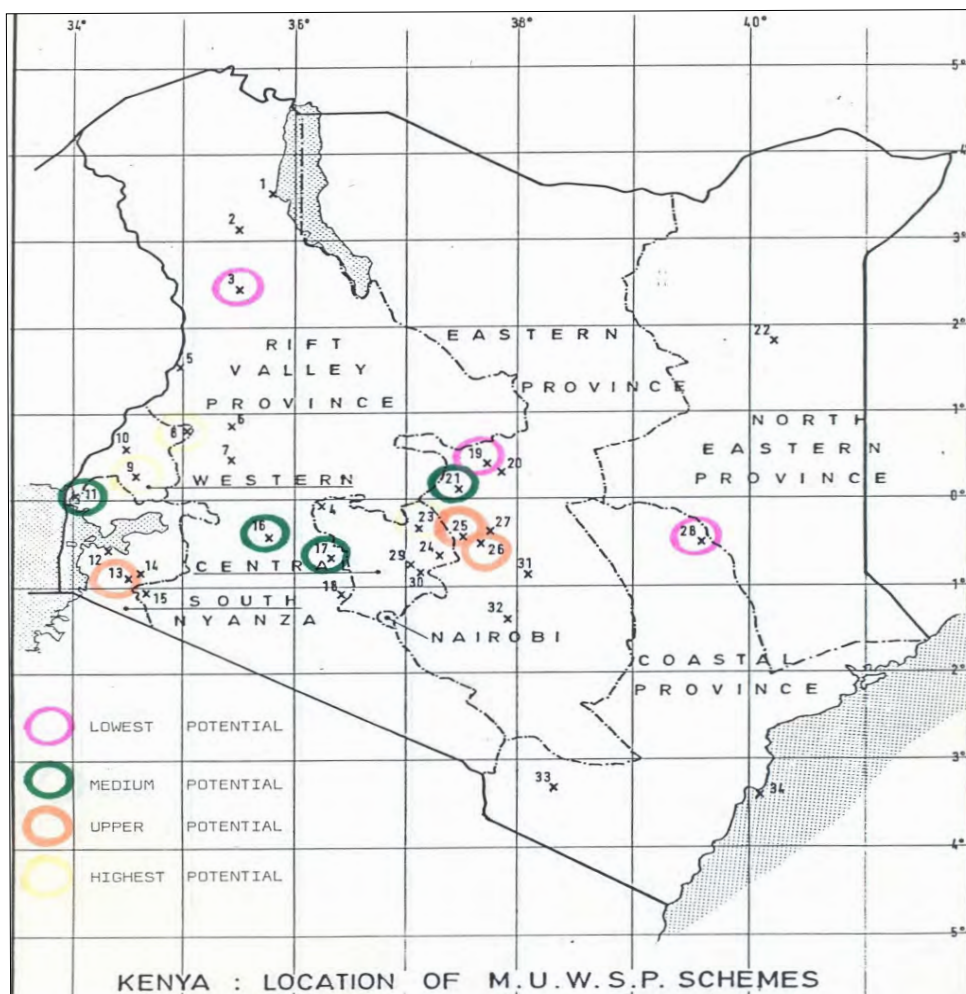

Figure 3.13: Map Showing location of Minor Urban Water Supply Schemes²¹²

²¹² Nor consult A.S (1988). Development of an Integrated Physical/Financial/Socio-Economic Monitoring and Evaluation Programme for Water Supply Schemes, Draft Final Report, Report No. 9. Ministry of Water Development, Republic of Kenya.

Although many schemes provided regular service to the consumers, there were also many schemes where interruptions of the supply were frequent. The shortage of recurrent funds affected the long term sustainability. Preventative maintenance and repairs were not up to standard, and an early need for rehabilitation was the result. The evaluation study pointed at the limited social reach with 40% of the resident population not utilizing the water supplies.

The population groups not served belonged to the poorest segments of the urban dwellers. The existing tariff structure and lack of viable methods of distribution through communal water points aggravated this situation. It came out that the need for a strong element of community participation, involvement of women and public education were very important²¹³.

The centralized implementation model (role of the Ministry of Water Development headquarters) contributed to the following shortcomings of the MUWSP²¹⁴:

Lack of cooperation between the MoWD, MoH and MoLG.

Limited involvement of the district administrations (District Development Committee, District Water Engineer).

Limited sustainable institutional development.

Programme organisation not conducive to decentralisation and delegation of power/responsibility. Table 3.11 shows the cost estimate for the MUWS programme as originally proposed in December 1973.

Table 3.11: Cost Estimate for the MUWS programme by 1973

Description	Cost (KES x 10 ⁶)
Construction of 35 water schemes	39.620
Construction of 7 sewerage schemes	4.801
Engineering services and equipping of the stores, workshops, and offices	2.560
Water laboratory	2.886
Sewerage training school	0.360
Water resources survey	0.182
Stores fund	1.00
Water department overheads	1.522
Contingencies 15%	9.594
Sub total	72.00
Price increases	18.00
Total	90.000

213 HIFAB International (1988). Report of Appraisal Mission: Minor Urban Water Supply Programme 1988-1992, Proposed by the Ministry of Water Development, Kenya in March 1988. Ministry of Development Cooperation (NORAD) April 1988.

214 HIFAB International (1988). Report of Appraisal Mission: Minor Urban Water Supply Programme 1988-1992, Proposed by the Ministry of Water Development, Kenya in March 1988. Ministry of Development Cooperation (NORAD) April 1988.

MUWSP recognized the value of community participation, therefore, ensured that women took part in the planning and implementation of water and wastewater related activities. Women often knew the benefits about of doing things together, lending a helping hand and developing new solutions to old problems. Women were considered very knowledgeable about water and water management was their responsibility²¹⁵.

One of the inherent problems of the MUWSP was that it placed much more emphasis on the technical engineering aspects of water supplies to the relative neglect of institutional building for self-sustenance and viability. This was regrettable in the light of the fact that half of the water supplies assisted under the programme were located in towns with established local urban authorities which could form the basis for the institution building necessary for the management of water supplies. Of the 35 centres assisted between 1974 and 1988, seven had municipal councils while 9 were managed by the local town councilsthis is illustrated in Table 3.12²¹⁶.

Table 3.12: District wise distribution of the Minor Urban Water Supply Schemes

	Scheme name	District	Province
1	Kalakol	Turkana	Rift Valley
2	Lodwar	Turkana	Rift Valley
3	Katilu	Turkana	Rift Valley
4	Kacheliba	Turkana	Rift Valley
5	Iten	Elgeyo Marakwet	Rift Valley
6	Chepkorio	Elgeyo Marakwet	Rift Valley
7	Turbo	Uasin Gishu	Rift Valley
8	Kilgoris	Narok	Rift Valley
9	Njoro	Nakuru	Rift Valley
10	Naivasha	Nakuru	Rift Valley
11	Homa Bay	South Nyanza	Nyanza
12	Rongo	South Nyanza	Nyanza
13	Kisii	Kisii	Nyanza
14	Bungoma	Bungoma	Western
15	Port Victoria	Busia	Western
16	Kakamega	Kakamega	Western
17	Isiolo	Isiolo	Eastern

215 HIFAB International (1988). Report of Appraisal Mission: Minor Urban Water Supply Programme 1988-1992, Proposed by the Ministry of Water Development, Kenya in March 1988. Ministry of Development Cooperation (NORAD) April 1988.

216 HIFAB International (1988). Report of Appraisal Mission: Minor Urban Water Supply Programme 1988-1992, Proposed by the Ministry of Water Development, Kenya in March 1988. Ministry of Development Cooperation (NORAD) April 1988.

18	Muthara	Meru	Eastern
19	Meru	Meru	Eastern
20	Embu	Embu	Eastern
21	Ena	Embu	Eastern
22	Ishiara	Embu	Eastern
23	Garissa	Garissa	North Eastern
24	Kitui	Kitui	Eastern
25	Mwingi	Machakos	Eastern
26	Wajir	Wajir	North Eastern
27	Oi Joro Orok	Nyandarua	Central
28	Limuru	Kiambu	Central
29	Karatina	Nyeri	Central
30	Sagana	Kirinyaga	Central
31	Murang'a	Murang'a	Central
32	Kahuro	Murang'a	Central
33	Wundanyi	Taita	Coast
34	Malindi	Kilifi	Coast

The MUSWP indicated that water supplies should raise sufficient resources for operations and Maintenance as government resources had become increasingly strained and had not kept pace with the rate of growth in demand for operation and maintenance resources. Two issues were involved, the issue of prices and tariffs and the issue of poor revenue collection situation documented in various studies. Given the relatively poor operation performance of water supplies in Kenya, it was commendable that the proposed 1988-1992 programme devoted considerable resources to Operation and Maintenance support. However, this did not happen²¹⁷.

A 1988 evaluation found out that programme execution was generally efficient in terms of physical progress but that the overall assistance on the whole was unsatisfactory. Problems related to institution building, management development, training, O and M services and social relevance were identified. While questions about financial and operational aspects of the schemes, particular concern was voiced about the lack of information about social coverage.

NORAD funded projects covered only a relatively small part (10% to 12%) of all schemes (Rural and urban), operated by MoWD by 1988. Nor consult (1988) observes that by 1986, there were 298 schemes, 202 of which were classified as rural. The distinction between rural and urban was a bit ambiguous especially in minor

217 HIFAB International (1988). Report of Appraisal Mission: Minor Urban Water Supply Programme 1988-1992, Proposed by the Ministry of Water Development, Kenya in March 1988. Ministry of Development Cooperation (NORAD) April 1988.

urban areas where the schemes were spatially spread over a very large area with low population density and where much of water was used for agriculture as well as domestic/industrial/commercial/institutional purposes.

However, it is worthwhile to note that despite the small number of schemes, NORAD financial contribution to MoWD was significant; NORAD at the same time had a growing interest in the social impacts of the projects therefore very relevant in the future²¹⁸.

Integrated physical/financial/socio-economic monitoring and evaluation programme for water supply: The monitoring and analytical system initiated by the MoWD was regarded very important. NORAD supported the idea and it was agreed that it should be given the necessary support for further development and operation on regular bases. The major purpose of the system was²¹⁹:

Provide a basis for improving planning of future water schemes.

Providing a basis for improvement of the user charges system and community participation strategies.

Providing a basis for financial controlling.

Providing a general database for policy making in the MoWD.

Such an approach to monitoring and evaluation was complex, especially in that one was dealing with great variety of types of data. Consequently, the MoWD engaged a consultant to assist further developing the monitoring and evaluation system. Specific objects of the projects were:

- The existing approach to monitoring and evaluating physical data was related to investment, operations and maintenance, and financial information. The system was underway in the MoWD and was successful although shortage of trained personnel was a major challenge.
- The monitoring and evaluation of social change resulting from the implementation of various MoWD schemes. This was very weak and the lack of reliable data in social economic characteristics made a complete evaluation of the sociologist aspects of the existing MUWS schemes difficulty.
- The analysis of possible methods for integrating social data with physical and finance data.

218 Nor consult A.S (1988). Development of an Integrated Physical/Financial/Socio-Economic Monitoring and Evaluation Programme for Water Supply Schemes, Draft Final Report, Report No. 9. Ministry of Water Development, Republic of Kenya.

219 Director of Water Development (1988). Minor Urban Water Supply Programme MUWSp 1988-92. Ministry of water Development Nairobi.

- The preparation for implementation in evaluation of all full evaluation/monitoring system required setting and testing the system as well as the development of training programmes. For appropriate staff at all levels for the required survey and analysis work²²⁰.

The consultant was asked to review existing methods and systems of collecting data on physical and finance performance, review data formats, currently employed and evaluated their appropriateness.

- Develop social and data collection and possible field methodology.
- Evaluate various data formats and develop a consistent overall format and methodology.
- Design a data processing model and actual monitoring and evaluation.
- System development, testing, modification.
- For purposes of field implementation, develop some ideas for a training course and setup possible systems and methods for data collection.

The existing monitoring and evaluation procedures involved a computerized system, for analysing financial and operational records gathered by operators of various schemes in the field, initiated by the MoWD around 1983. However, despite these efforts, the data received from the field were unreliable and lacked social content. After evaluating the 34 NORAD funded MUWSP schemes using available data, Nor-Consult developed the following preliminary classification system²²¹:

a) Urban schemes

- Fairly large towns with population of over 2500.
- Good maintenance procedures.
- Good control over production and sale of water.
- Nearly all connections already metered and adequate system of revenue collection.

b) Minor urban schemes

- Towns with a population less than 2500.
- Adequate maintenance a problem.

²²⁰ Nor consult A.S (1988). Development of an Integrated Physical/Financial/Socio-Economic Monitoring and Evaluation Programme for Water Supply Schemes, Draft Final Report, Report No. 9. Ministry of Water Development, Republic of Kenya.

²²¹ Nor consult A.S (1988). Development of an Integrated Physical/Financial/Socio-Economic Monitoring and Evaluation Programme for Water Supply Schemes, Draft Final Report, Report No. 9. Ministry of Water Development, Republic of Kenya.

- No proper control over production and sale of water.
- Limited metered connections and no proper system of revenue collection.

c) Rural schemes:

- Either population less than 1000 or supply area larger than 15km²
- Proper maintenance not possible due to remoteness
- Control over production against sales not adequate
- No system of revenue collection

This classification was subjective and was based totally on available documentation. It was not as a result of detailed field investigation. However, it was expected to serve the purpose of technical and operational work²²².

Methods of accounting for water production and distribution were identified by Nor-Consult Consulting Engineers, Architects and Economists in 1989 first monitoring and evaluation attempt by the MoWD.

The monitoring and evaluation established that most of MoWD schemes did not work within this framework. Master metering was a major challenge and it was not possible to ascertain whether one was dealing with gross production or net production. There were illegal connections, poor data recording, malfunctioning metres etc.²²³.

The system involved: socio-economic aspects, the computer centre, evaluation of the system, staffing structure in MoWD relevant to monitoring and evaluation project, development of computerized system could analyse operational and financial data monthly, socio-economic data quarterly or semi-annually, trend analysis on quarterly or semi-annually basis. This was where major challenges were found. There were also challenges regarding the high rate of turnover²²⁴.

Nor consult observed that having invested around KES 600 million in MUWSP, having no one who had a good understanding of the whole programme, and no one seemed to know about how the systems functioned in the field, it was not possible to proceed with monitoring and evaluation programme. This was probably because the same problem 'unsure information' could be replicated in few years' time.

222 Director of Water Development (1988). Minor Urban Water Supply Programme MUWSP 1988-92. Ministry of water Development Nairobi.

223 Nor consult A.S (1988). Development of an Integrated Physical/Financial/Socio-Economic Monitoring and Evaluation Programme for Water Supply Schemes, Draft Final Report, Report No. 9. Ministry of Water Development, Republic of Kenya.

224 Director of Water Development (1988). Minor Urban Water Supply Programme MUWSP 1988-92. Ministry of water Development Nairobi.

Therefore the consultant recommended that a programme should be established to systematically examine all 34 schemes with the following details²²⁵:

History, original and subsequent targets, simple sketch diagram, source of water, treatment procedures, production levels/sale/unaccounted for water, metering systems, number of metered clients and type, age of various components and staffing. Such an analysis would then give a basic profile of each scheme /operational manner. It could explain some inconsistencies that could become apparent once the computerised monitoring and evaluation system was operational.

3.3.2.1 Coast Province Water Supplies

Lamu Township water supply: Lamu Township is in Lamu district which is one of the seven districts that made up the Coast Province. The District lies between Longitudes 40° 15' and 40° 38' East and Latitudes 1° 40' and 2° 30' South of the Equator. Lamu occupies the northern-most part of the Kenyan coast. The District had one local authority, the Lamu County Council which had 23 wards. By 2003, Lamu town was the largest town on Lamu Island. Mokowe was the mainland town directly north of Lamu Island and connected to it by a short boat ride²²⁶. Initially water was obtained from the wells. The Lamu water supply served the town of Lamu, the village of Mokowe on the mainland and Ras Katau Hotel on Manda Island. The system used water abstracted from a fresh water aquifer in the sand dunes on the south of Lamu Island.

225 Nor consult A.S (1988). Development of an Integrated Physical/Financial/Socio-Economic Monitoring and Evaluation Programme for Water Supply Schemes, Draft Final Report, Report No. 9. Ministry of Water Development, Republic of Kenya.

226 Coast Water Services Board (2012). Water Supply Master Plan for Coastal Region; Water Demand and Supply Assessment Report.



Figure 3.14: Coastal region water balance²²⁷

Twenty artesian wells spread over three kilometres, obtained water from the aquifer and electric pumps in each well delivered it to a 45 m³ storage tank in the middle of the well field. At the tank water was disinfected with chlorine and then pumped five kilometres to a 450 m³ storage tank on a hill on the west side of the town. The area covered by the reticulation was about 60% of the town; the inhabitants outside the area of supply drew water from the wells. Throughout the town, there were 165 wells and over 1000 individual house connections. The water in the wells received no treatment although fish ate the mosquito eggs and larvae. The public

227 Republic of Kenya (2008). Bulk Water Supply System: Feasibility Studies, Identification of Institutional Support. Ministry of Water and Irrigation on behalf of Coast Water Services Board by BBL ingeniens consultants with Gibb Africa ltd.

health officer inspected the wells regularly, the wells were health hazard and likely to be contaminated by pit latrines²²⁸.

In general there was an increase in the number of people who had access to a reasonably good quality and quantity water supply. The spring's protection continued in all African areas. Public supplies were subjected to bacteriological examination at regular intervals, with the exception of some supplies at the smaller towns and divisional centres and satisfactory results were achieved. Many water supplies inspected contained high fluoride content²²⁹.

After the World War II, the British government, under the Colonial Development and Welfare Act, invested in the British colonies to boost economic and social development²³⁰. In the Kenyan colonial context, economic growth meant agricultural expansion, which required development and management of water resources. In Kenya, the colonial government in 1946 launched an ambitious investment programme under the Development and Reconstruction Authority (DARA). The DARA was to spend over £15million over 10 years, which included grants from the British government, with about 1.2million dedicated to water development. The DARA programme sparked off a rapid development of urban water supplies. Minor towns' water supplies were seen as, vital for the development of the country, and as the expenditure involved is normally recoverable through the rates charged, it was in every way a suitable object for the allocation of Development Funds²³¹."

Emergency Camps Lamu district water supply: Between 1952 and 1954, six emergency camps were established in Lamu district²³². By July 1954, four camps Mwana, Hindi, Mkonumbi and the camp at Manda Island were occupied. Another detention camp was being built in 1954 and a small detention camp for Asians was being built. Two prisons on the mainland had been closed for duration of rains and the prisoners had been withdrawn from Mkonumbi and Hindi camps. Another camp was proposed for construction near Garissa to hold 300 prisoners²³³.

228 Waweru and Associates and Rofe Kennard and Lapworth Terrapian Kenya (1980). Third Urban Housing Project Interim Report No. 1 Volume A: The Towns. Republic of Kenya, Ministry of Housing and Urban Development.

229 Walker A. J (1958) Medical Department Annual Report, 1957; Kenya National Archives BY/9/313 6th June, 1958.

230 Fielhouse D. K (1999), *The West and the Third World: trade, colonialism, dependence, and development*, Blackwell Publishers, Oxford 1999.

231 Colonial Office (1950), *Annual Report on the Colony and Protectorate of Kenya for the year 1948*. His Majesty's Stationery Office, London.

232 Medical Officer of Health, (1956). *Hola Works*. Kenya National Archives, BY/6/1, Ref: 36.53/Vol. VI/21. 4th October 1956.

233 Stott H (1954). *Emergency Camps-Lamu District*. Kenya National Archives, BY/6/12. 22nd July 1954.

Water supply to all camps was considerably restricted and only Manda Island detention camp got almost 450 litres per head per day as per the standard requirement in the camps in other parts of the country. All camps on Manda Island were situated near the sea and this was used by prisoners for bathing. The mainland camps however were more pressed. For instance, at Hindi only just over 4.5 litres per head per day were available for washing, drinking and cooking. The water from all camps was supplied from well situated near the sites except in the case of Mwana Prison camp where water was brought in drums daily by boat from Lamu²³⁴.

Hola Prison camp: The Hola Prison was enclosed with a barbed wire and contained the following buildings; (a) Mud block gable ended huts with corrugated iron roofs, (b) 7 A- flamed structures, (c) a Kitchen made of burnt bricks (d) twenty four bucket latrines and (e) Shower baths²³⁵. Water supply at the camp was obtained from Tana River and was primarily for experimental irrigation scheme. It was available for five hours a day. The consumption was 136m³ per day. This prevented full sedimentation and treatment all the time, as the existing capacity of the tank was 91m³ per day. Untreated water with very strong sediment content was frequently the case at the prison. The officer in charge proposed provision of more sedimentation tanks²³⁶.

The money to convert the existing water supply pipe from Tana River to a wastewater sewer had been approved in September 1958. The irrigation camp was designed to be extended to accommodate 800 persons [detainees in the first instance and then villagers. The water supply and a treatment plant were required but about twice the size of the first plant. The policy on the Tana River was to withdraw villages from the flood plain to re-establish them on higher ground, which meant removing people from their traditional water supply. Provision of water was to be made by digging wells. There was a proposal to consider UNICEF grant²³⁷.

The only water supply for irrigation scheme was River Tana, which reached the villages after a distance of about 24 kilometres along the main canal to which it was raised by pumping from the river. A treatment plant was put in place and treated 16 m³ of water per day. This gave each person an average of 40 litres per day. The plant was built by detainee labour²³⁸.

234 Stott H (1954). Emergency Camps-Lamu District. Kenya National Archives, BY/6/12. 22nd July 1954.

235 Hufford, J (1959). Hola Irrigation Scheme, Penal and Detention Establishments, Hola Tana River District, Kenya National Archives, BY/6/2, Ref: K/21/1. 20th May 1969.

236 Waddicar, H (1958). Report on Hola Safari. Kenya National Archives, BY/6/2, Ref: K.13/115. 22nd September 1958.

237 Waddicar, H (1958). Report on Hola Safari. Kenya National Archives, BY/6/2, Ref: K.13/115. 22nd September 1958.

238 Waddicar, H (1958). Settlement Schemes in Kenya. Kenya National Archives, BY/6/2. 28th October 1958.

Mackinnon and Manyani Prison Water Supply: A unique characteristic of Manyani and Mackinnon prisons was that the population, facilities and structures diminished with time. The population of Manyani in 1954 was 17,000²³⁹. And by 1957 it had fluctuated to 9000. The population of Mackinnon Road prison was 7500 by 1954 and reduced significantly. This notwithstanding the downward trend continued²⁴⁰.

By May 1956, the water supply was sufficient owing to connection with Mzi-ma-Mombasa pipeline. Maxwell's June 1956, inspection established that the water supply position remained satisfactory²⁴¹. July inspection found water shortage and henceforth rationing having gone on for a month. Water was available to the Europeans only throughout the day and rationed in other quarters. It was treated through chlorination²⁴². In August, the camp was relying upon Tsavo water supply and the amount obtainable was limited. Maxwell observed that unless Mzima water supply was reintroduced, the situation could not be completely satisfactory. In an attempt to reduce water consumption, which was excessive, rationing was practiced. However, this restriction was not sufficient to cause a saving capable of raising the storage level on the reservoir. Consequently, some parts of the camp could not get their full quota. There was a considerable wastage in the camp due to the showers and taps being left running to irrigate the gardens in the lines. Generally, the condition of the camp had improved despite the much drainage and other structural defects²⁴³. Water consumption in the camp had decreased from 818 m³ to 455 m³ per day.

Kwale Water Supply: In 1945, the Senior Medical officer of Health, Coast Province indicated that the Kwale water supply consisted of two shallow muddy holes in a gully below the prison camp and lines. Pit latrines were, and had been used immediately above the water holes. Within the same year a successful borehole was sunk and on 1st of January 1946 the water supply was commissioned²⁴⁴.

The Mombasa Pipeline Board played an important part in the field of water supply through the Act Cap 372 that came into effect in 1957. The Board was charged with the responsibility of administering the bulk supply of water to Mombasa and its environs. Similarly, it was in charge of constructing bulk delivery pipelines to

239 Hemsley B.W (1954). Prison Department Emergency Expenditure: Sanitation Mackinnon and Manyani. Kenya National Archives, JZ/15/1. Ref: ANV/P/12. 21st May 1954.

240 Waddicar, H (1958). Inspection of Manyani Camp 14/2.59. Kenya National Archives BY/49/3. Ref: K.T.7/3.20th February 1959.

241 Maxwell D.C (1956). Manyani Special Camp. Kenya National Archives, By/49/3. Ref: K.T.7/3. 26th June 1956.

242 Medical Officer of Health, Teita District, (1956). Manyani Special Camp. Kenya National Archives, BY/49/3, Ref: 6.66/A/31/56.19th July 1956.

243 Maxwell, D.C (1956). Manyani Special Camp. Kenya National Archives, BY/49/3, Ref: K.T.7/17, 23rd August 1956.

244 Colony and Protectorate of Kenya (1928-50). Water supplies Kwale and Digo District, Kenya National Archives, Ref. No. CA/17/95, Nairobi, Kenya.

other towns around Mombasa. For the day-to-day operations of its installations, the water department acted as the operating agent²⁴⁵.

There was a lot of shallow ground water of good quality that could be tapped using shallow wells. The area west of coastal zone which essentially covered the Simba Hills was known to have good quantities of ground water that fed the perennial streams and rivers that flowed out of the area into Indian Ocean. In addition, springs were known to exist in all sides of the Simba Hills and some of the springs were already in use by the local communities as sources of their domestic water supplies²⁴⁶.

In 1986, in order to give hygienic small point sources of water spring protection and, where possible, construction of storage and short gravity fed pipelines, the government of Kenya and the Swedish Government through SIDA agreed to implement shallow well technology project in Kwale. A survey consequently conducted identified about 166 springs in the Simba Hills area, and selected 45 springs and recommended them for development into water supply points. Horizontal drilling or construction of spring boxes was recommended in order to improve the gravity flow to families downstream the intake. Shallow wells as a source of village water supplies were recommended in Mkongani area where there were no perennial springs²⁴⁷.

Kilifi Water Supply: Kilifi District is one of the seven districts in Coast Province. The shoreline is 144 km from Mtwapa creek to Mida creek. The District bordered Taita Taveta District to the West, Malindi District to the North West and Mombasa and Kwale District to the South. Kilifi station was set up in or about 1918. The question of water supply arose immediately in the year and a request was put to the Executive Engineer Mombasa for a grant to buy water tanks and sink a well. In July 1918 the Assistant District Commissioner (ADC) in charge of the station sunk a well, the position of which was decided by Mr. Lillywhite's divining instrument. In 1919 an individual, Sheikh Ali bin Salim, contributed Rs 750 towards the construction of another well²⁴⁸. Three of the wells were not successful and the station continued to rely on rainwater (using three roof tanks) that was unreliable.

In 1923, the Public Works Department completed building a dam at Mariakani to hold up to ten million gallons. The thickly populated region was in the

245 Colony and Protectorate of Kenya (1928-50). Water supplies Kwale and Digo District, Kenya National Archives, Ref. No. CA/17/95, Nairobi, Kenya.

246 Nor consult A.S Consulting Engineers, Architects and Economists (1986). Kwale District Community Water Supply and Sanitation Project: Report on Spring Survey in Simba Hills Area. Nairobi.

247 Nor consult A.S Consulting Engineers, Architects and Economists (1986). Kwale District Community Water Supply and Sanitation Project: Report on Spring Survey in Simba Hills Area. Nairobi.

248 Colony and protectorate of Kenya, (1918-1929). Water Supplies- Kilifi District, PC/Coast/2/8/26 Kenya National Archives, Nairobi, Kenya.

dry season and without water and natives were buying water from the railway²⁴⁹. However, in 1926, the scarcity of water supply became chronic. The reservoirs went dry and people were forced to walk for approximately ten Kilometres in search of fresh water. Assistant District Commissioner observed that development of Kilifi was under jeopardy until adequate water provision was made. Similarly administrative organisation could not be effected under such circumstances²⁵⁰.

In 1927, water completely ran out. The population resulted in fetching water across the harbour in tins and the transporting to back using boats. This denied the station of labour supply and causing extreme inconveniences. Consequently, a proposal was made for boring water in 1928²⁵¹.

The fourth well sunk was blackish. The station continued to rely on rainwater until 1929 when a supply from a borehole was installed²⁵².

In 1928, Kilifi was made a district headquarters rather than Malindi. The Native Councils were very active and this led to building of two new dams at Vitengeni and Ndigiria areas. Considerable efforts were made to stamp out hookworm and latrine digging was still in full swing in the reserve. All the medical efforts were greatly appreciated by the tribes. The state of water supply remained unsatisfactory as 152 metres deep was drilled and no water was found. Meanwhile, arduous water carrying over the creek by boat continued to the general discomfort of the station and cramping of its development²⁵³. The station continued to rely on rainwater until 1929 when a supply from a borehole was installed.

In December 1929, water boring was started and sufficient money was voted for the four holes. At the boma there were no satisfactory water was found, another site, three kilometres inland from Kilifi was selected by process of divining twigs and plentiful supply of water 40,000 gallons (182m³ a day was obtained at 75 metres down. Although portable, its quality was not satisfactory. A 10,000 gallon tank was built upon the Kilifi Hill and water was gravitated thence to stand pipes in the station²⁵⁴.

249 Assistant District Commissioner (1924). Kilifi Annual Report for 1923. Kenya National Archives, DC/KFI/1/1. 8th January 1923.

250 Assistant District Commissioner in Charge, Kilifi (1927). Kilifi Sub-District Annual Report, 1926, DC/KFI/1/1/2. 1927.

251 Assistant District Commissioner in Charge, Kilifi, (1928). Kilifi District Annual Report, 1927, DC/KFI/1/1/2. 1928.

252 Colony and protectorate of Kenya, (1918-1929). Water Supplies- Kilifi District, PC/Coast/2/8/26 Kenya National Archives, Nairobi, Kenya.

253 District Commissioner in Charge, Kilifi (1929). Kilifi District Annual Report, 1928 DC/KFI/1/1/2. 1929.

254 District Commissioner in Charge, Kilifi (1930). Kilifi-District Annual Report, 1929, DC/KFI/1/1/2. 1930.

Lack of it was a severe drawback and a need to develop a sub-terranean resource of Kilifi district was felt. The finding of water was done by the locally available Mrs Montgomery who advised on where to bore. Three boreholes had been established within a small distance of over half the native population, capable of producing from 14,000 to 21,000 gallons. At one borehole there was a wind mill and engine pumping plants were installed on the other two. The administration carried out the work of organizing and arranging the installation and maintenance of the plants.

The water supply of the future was thence assured due mainly to the bold enterprise of the provincial commissioner and the district commissioner. A systematic hookworm campaign was started in 1930 with an objective to ensure that every hut was provided with pit latrine. To this end a total of four hundred pits were dug and the campaign had by the end of 1930 gathered momentum²⁵⁵.

Kilifi Water and Sanitation Project: Kilifi water and sanitation project was a community-based Ministry of Water Development project set up originally in 1985 but launched in 1988 under funding by the German Government through GTZ (German Agency for Technical Cooperation). Phase I of the project covered the period July, 1988 to December 1990 while phase II of the project covered the period January 1991 to December 1993.

The project covered parts of the Bahari and Ganze divisions of Kilifi District with the specific aims of: Educating communities on water, hygiene and sanitation; educating school children in schools on hygiene and sanitation; providing water through water pans, rainwater harvesting facilities, pipeline construction and wells; and providing subsidized VIP latrine slabs and vent pipe with mosquito gauze.

The project also constructed water kiosks and small dams. Rainwater harvesting facilities included ferro cement tanks in schools²⁵⁶.

Kilifi Water Supply: The Executive Engineer, PWD, Mombasa on 9th September 1934 wrote to the Director Public Works Department on Kilifi water supply identifying the existing water supplies as²⁵⁷.

A supply of blackish water pumped from a well to a storage tank on hill and gravitating from there to a number of connections in the Boma.

255 District Commissioner in Charge, Kilifi (1931). Kilifi-District Annual Report, 1930, DC/KFI/1/1/2. 1931.

256 Murage J.W.V. (1991). Kilifi Water and Sanitation Project, Project Half-Yearly Report, Ministry of Water Development, Nairobi, Kenya.

257 Colony and Protectorate of Kenya (1929-1949). Water Supplies in Kilifi District including Malindi, ref. CA/17/89, Kenya National Archives, Nairobi Kenya.

A rainwater catchment area consisting of:

- A large concrete pan 87ft. x 84ft. drawing into 4 inter-connected concrete lined underground tanks, having a joint capacity of 11,132ft³.
- A small concrete pan 30ft x 20ft drawing into a concrete lined underground tank having a capacity of approximately 4,544ft³.

The Engineer went ahead to note that during the year no difficulty was experienced in the pumps system and there was a likelihood of small surplus of funds remaining at the end of the year. However, the rainwater catchment scheme had given considerable trouble, both the concrete catchment apron and the tanks needing repair. No funds had been provided for the latter's service, which was an integral part of Kilifi Boma Water System and as important or more important than the pumping scheme as it provided the whole drinking and cooking water for the Boma. The engineer sought vide this letter, authority to spend the surplus from the pumping scheme to make good the faults from the rainwater catchment scheme.

On 18th July 1939, the District Commissioner Kilifi wrote to the Provincial Commissioner Coast on Kilifi water supply in which the following emerged²⁵⁸:

The DC had discussed with Mr Tetley (Hydraulic Engineer, public works department) and Mr Robins on some issue relating to Kilifi water supply but the discussion was unfruitful since Mr. Tetley was not prepared to retreat from the departmental position that the consumption of water by persons who do not pay for it was wrong or to admit that consumption could be reasonably controlled without metres.

While Mr Tetley had taken much trouble to assist the DC in elucidating matters of which the DC was ignorant but the DC was still of the opinion that it was not desirable to introduce the metre system in Kilifi even if, as Mr. Tetley had suggested, metre rent were waived.

The DC explained that by the terms of Mr Lillywhite's contract, he received 150 pounds every year for supplying up to 3273 m³ and extra remuneration if the amount exceeded that figure. It appeared that the average amount supplied did not exceed the above figure except once probably 1935 when the contractual amounts exceed. This showed that Kilifi water supply was contracted to a private operator.

There was however, a considerable amount pumped by Mr. Lilywhite into an overflow tank, which did not pass through the metre and was therefore pumped at his expense. That water was used by his labour and by employees of the Agricultural

258 Colony and Protectorate of Kenya (1929-1949). Water Supplies in Kilifi District including Malindi, ref. CA/17/89, Kenya National Archives, Nairobi Kenya.

Department at Kibarani as well as by natives on the road. It was not used when there was rainwater available in the water holes.

It was, however, the case that the supply of borehole water had never failed and was believed to be practically inexhaustible, so it could be said that the extra consumption neither jeopardised the supply nor increased the cost of operation.

With regard to the supply to the township, which was recorded on the metre, there were existing thirteen connections, of which ten paid a flat rate of KES 10 per month. The DC's earlier proposal was that all connections were to pay, which would provide revenue of nearly KES 130 per month. The amount paid on the basis of an average consumption of 259 m³ at the rate proposed, viz. KES 3 per 4.5 m³, would apparently be KES 171. No such revenue would, however, accrue as the DC would find it necessary to dispense with three stand pipes and to arrange for strict rationing of the supplies to native employees while the five connections to the houses of non-natives would probably show a reduction from KES 10 to KES 6 for each house.

The DC would not admit that KES 3 per 4.5 m³ was a fair charge for water of that quality. As he had previously observed that the charge was for water which is good for all purposes, whereas the Kilifi water was good for none. The waiving of metre rent was merely the removal of a minor irritation which seemed inseparable from the finance of water supplies and would make no appreciable difference to the revenue.

According to the DC, the net result of the proposed metre control on the township would:

- to increase the work of accounting;
- to divert staff employed for other and more useful purposes to controlling the use of water;
- to “deprive natives coming to Kilifi - many from long distances- of water for drinking and washing their bodies”; and
- to reduce the income as compared with what he had proposed, - slightly if the KES 3 rate, and largely, if a fair rate were adopted.

He also noted that the gain, according to the other option (metering) was that waste would be eliminated and people would not be using something, which has an ‘economic value’ for nothing. He however, admitted that

“waste, if it meant leaving taps running unnecessarily, was to be deplored, but if it means that a man native or non-native uses water to bathe his body thoroughly when the supply is in abundance, the word waste ceases to have any moral significance”.

Any water in excess 3273 m³ limit was supposed to be released for use by natives for free.

The DC had not taken into consideration the question of overflow pumped into Mr. Lillywhite's tank at Kibarani. He understood that the opinion of the Director of Public Works was that the supply to Kibarani also had to be put to metre rate. As this was outside the township the connection did not seem to be enforceable under the Township (Water Works) Rules, 1934 nor did the DC know if a charge could be created. Presumably Mr Lilywhite could be prevented from using the water. Apart from a slight inconvenience to him- he had other sources of supply- the immediate results of prevention would be to deprive the employees of the Kibarani Experimental Station of a ready water supply and to withdraw it also from wayfaring natives. Both Mr Lilywhite and the senior agricultural officer had expressed their readiness to contribute the KES 10 flat rate.

It would be seen, as pointed out by the DC, then, that if a flat rate of KES 10 per month was extended to all connections in the township and to the water consumed by the Kibarani labour, a monthly revenue of nearly KES 150 could be anticipated probably without extra operation expenses and without depriving natives, who were responsible for about 90% of the total consumption, of the water and without necessitating any more control than could be required to keep consumption within reasonable limits in the dry months. The DC observed that the township was a purely Government station and that, apart from four small shops which he agreed should pay for their water, the supply was installed to meet the necessities of those who had to work there and for natives who came to the Boma chiefly on government business. To restrict the supply seemed to be indefensible to the DC and he mentioned at this point that the probability that the supply, although underground, came within the definition of a 'body of water' as defined in section 2 of the Water Ordinance, No. 35 of 1929, and was accordingly outside the control established by section 4 (2) as being in the protectorate²⁵⁹.

Mr. Tetley told the DC that the Dera supply though not immediately practicable, needed by no means be abandoned and he suggested that, as the supply was within a native area and natives would be overwhelmingly the greatest consumers, the scheme could be considered for inclusion in the programme to be financed from the Colonial Development Fund.

259 Colony and Protectorate of Kenya (1929-1949). Water Supplies in Kilifi District including Malindi, ref. CA/17/89, Kenya National Archives, Nairobi Kenya.

A report dated 4th September 1940, to the Director of Public Works from the Hydraulic Engineer, public works department, on investigations for a new source of supply for Kilifi Water Supply contained the following recommendations²⁶⁰:

The existing water supply from the borehole at Kilifi was not suitable for domestic use.

The proposed rainwater catchment area and reservoir to provide a supply of 20 m³ per day would cost approximately KES 300,000 and even then it would at times be necessary to ration further the quantity of water. This scheme to be held in abeyance pending the investigation of other sources of supply.

Conservation of a surface supply at Dera would not be successful. No definite conclusion could be drawn to the utilisation of the shallow sub-surface supply at that point as weather conditions were unfavourable at the time of the investigation.

Further investigations at an approximate cost of 130 be carried out immediately at Dera, and in the valley towards Mutondia in an endeavour to find a satisfactory shallow ground water supply.

The DC Kilifi on 26th June 1941 while reacting to a letter from the Director of Public Works on Kilifi Water Supply to the PC Coast Province was pleased with the progress of the scheme he observed that while the existing supply had been described aptly by a previous DC as “non-potable, will not lather with soap, rots clothes, corrodes pipes and kills plants” “can the new supply be described as usable for all purposes”? The Government Chemist described a sample of the water as highly mineralised and hard. “Is the Director of Medical services perfectly satisfied that the treatment to be given to this water will produce water that is really worth having?”

According to the DC this was by far and away the most important point, otherwise the inhabitants of the township would find themselves paying and paying heavily for a supply not much better than the existing and Government would have spent nearly £10,000, to but for little purpose.

The second point was the proposed charge of KES 4 per 4.5 m³. The DC exclaimed that this was the highest charge in Kenya at the time- in view of the fact that the running cost of the first 13.6 m³ per day was KES 3.30 per thousand and would drop to KES 1.93 per thousand when the demand reached 27.2 m³, and presumably less when the maximum of 54.5 m³ per day could be reached. He submitted that this charge of KES 4 per 4.5 m³ could be reduced to a reasonable figure, say KES 2 per thousand. The DC noted that presumably the Government

260 Colony and Protectorate of Kenya (1929-1949). Water Supplies in Kilifi District including Malindi, ref. CA/17/89, Kenya National Archives, Nairobi Kenya.

wished to encourage development but he observed that expensive water would be deterrent. The third point was metre rent. He presumed that the standard rate of KES3 per month was unduly high.

The fourth point was that the scheme under construction allowed for a maximum of 27.2 m³ and with a moderate extra expenditure could be increased to 54.5 m³. While agreeing that this amount (27.2 m³) was much more than the existing consumption he observed that it allowed of very little development. Kilifi had a small amount of Government land and a large amount of private land available for development; it had some three kilometres of shoreline alone.

Was the township to develop on the lines of Malindi the DC noted that even 54.5 m³ would not be sufficient. No allowance had been made for commercial development such as stall-fed dairy, fruit or fish canning or similar enterprise. He suggested that rather than retard the start of development the moderate extra cost of allowing a maximum of 54.5 m³ per day be included in the scheme under construction. The DC also noted that he understood that very few water supply schemes were self-supporting and what they lost on the savings of running and capital costs, they made up on the roundabouts of sale of land and rents, also other benefits coming from introduced capital²⁶¹.

The Director of Public Works in his letter of 15th September 1942 to the Provincial Commissioner Coast Province on Kilifi water supply noted that there had occurred a temporary increase in the salinity of the water in the Ndzovuni River proposed to be used for the supply Project. The increase in salinity was considerable, and to such an extent as to render the mineral content somewhat higher than desirable. Although the river water had come back to normal by this time, it was considered necessary to alter the intake to a site about one and half kilometre further upstream, and to abstract water from the ground water supplying the springs, a short distance from the river. This would involve lengthening the main by about 762 metres. The necessary surveys for the new site were being made at the time but the alteration would involve some delay in the construction of the purification works at Jaribuni, and the laying of the first three kilometres of pipeline to the balancing tank. The Director however, indicated that in the meantime preliminary work in connection with the new site would be proceeded with, also laying of pipeline from balancing tank towards Kilifi²⁶².

The District Commissioner Kilifi in his letter dated 21st December 1942 to the Coast Provincial Commissioner on Water For S.A.A.F at Kilifi told the PC

261 Colony and Protectorate of Kenya (1929-1949). Water Supplies in Kilifi District including Malindi, ref. CA/17/89, Kenya National Archives, Nairobi Kenya.

262 Colony and Protectorate of Kenya (1929-1949). Water Supplies in Kilifi District including Malindi, ref. CA/17/89, Kenya National Archives, Nairobi Kenya.

that he had been informed that the units (Military) at Kilifi proposed to get their fresh water by dhow from Mombasa in 180 litres petrol cans, 16 m³ at a time. He submitted to the PC that a more wasteful scheme could hardly have been thought of because of the following²⁶³:

- Dhow transport was unreliable and expensive.
- Tins had to be sealed or loss would be large.
- Unless packed in boxes many tins would be broken.
- Off loading facilities at Kilifi were poor.

The DC noted that pending the completion of the new Kilifi water supply he made the following submission on methods that could be investigated fully:

Condensing Plants: An RAF officer on a visit to Kilifi had told the DC that he had designed an efficient, cheap and easily made plant from a pair of petrol or oil drums and some piping; that he was in fact having a plant made at Eastleigh and sent there for experiment. There was a very large supply of fuel in the immediate vicinity of the aerodrome for cutting. No doubt a battery of condensing plants would be required to supply sufficient water for drinking purposes for the units there. The water to be condensed could be either sea water or water from a well; the latter being preferable on account of less solid matter.

- (a) **Wells:** There was already one well on the aerodrome; to prevent it from becoming too saline it was essential to pump it slowly and frequently. This was not being done- no right pumping was being done. This water was not suitable for drinking but was suitable for washing.
- (b) **Water at Mutondia:** (Not the well at the village). There was a swamp said to be permanent near the coast eight kilometres north of Kilifi. The DC had several times requested an aerial survey of the swamp to estimate the area of water and the best line for a road to link it to the main road to no avail.
- (c) **Water at Dera:** The presence of water had been established and it was a question off constructing shallow wells and some short motor tracks.

263 District Commissioner, Kilifi (1942). Water by Dhow. Ref. PW. /1/1/1942. Kenya National Archives, Nairobi, Kenya.

No doubt the water from (b) and (c) may require to be treated before use for drinking, said the DC. The units there had tanker Lorries equipped with pumps suitable for drawing water from reasonable distance or depth and used these Lorries to draw water from wells and from the Kilifi pipeline as it was. Incidentally drawing from the pipeline was a hardship on Mr. Lilywhite for he supplied the water to the Township at a flat rate per month irrespective of the quantity pumped.

The DC was writing the above because he felt that the local supplies had not been properly used or explored and he considered that that should be done before such an expensive method as bringing by dhow in debes) was brought to action. He requested the PC to bring this to the notice of the relevant Military authorities²⁶⁴.

The District Commissioner Kilifi in a letter dated 4th January 1943 to the Provincial Commissioner Coast Province on Kilifi water supply intimated the PC that he had been informed by the foreman that there was a shortage of pipes, and the end of the pipe line would be near Kibarani- three kilometres away from the township. Further that it would be unlikely that the work would be completed in the next four months. He continued to observe that delivery of water at Kibarani would be of no value at all to the township. He anticipated to have enough water from the rainwater tanks to last till the end of April by careful rationing for the civilian population but submitted that something had to be done to speed up the work and complete the piping. He further noted that Kilifi had suffered for many years from lack of an adequate water supply, there was a further delay of eight months in 1942 after the money had been granted before work was even contemplated and that the work had now come under the head of a military necessity than a civilian luxury and on these grounds the work should be pressed forward with all possible speed²⁶⁵.

By 1946, the existing water supply systems included boreholes, springs, dams, water holes, streams and rivers (Colony and Protectorate of Kenya, water supply records of 1941-49).

Kaloleni, within Kilifi, had by 1957 a water supply with water from a borehole identified as borehole No. 3. The safe yield of this borehole was 3.4 m³ per hour and the borehole equipment was designed to pump at this rate. A letter from the Divisional Engineer's Office in Mombasa of the Ministry of works, to the District Commissioner Kilifi confirms this²⁶⁶. In June 1957, the plant operation chart showed

264 Colony and Protectorate of Kenya (1929-1949). Water Supplies in Kilifi District including Malindi, ref. CA/17/89, Kenya National Archives, Nairobi Kenya.

265 Colony and Protectorate of Kenya (1929-1949). Water Supplies in Kilifi District including Malindi, ref. CA/17/89, Kenya National Archives, Nairobi Kenya.

266 Colony and Protectorate of Kenya (1929-1949). Water Supplies in Kilifi District including Malindi, ref. CA/17/89, Kenya National Archives, Nairobi Kenya.

that the borehole pump worked an average of 9 hours per day. This represented an average daily delivery of 30.6 m³. The Divisional Engineer seemed to be addressing a discrepancy between the pumped capacity and the average daily demand given by metre books and gave probable reasons as²⁶⁷:

The pumping hours could have been estimated wrongly; since there was no clock in the pump house.

The pump cup leathers could be worn out and had to be replaced.

There was bound to be some discrepancy between the quantity of water pumped and the quantity known to be used since there was an unmetered standpipe near to the pump house where, in the dry season, more than 100 debes (approximately 2000 litre) of water were collected each day.

Malindi and Watamu/Gedi Water Supply: Before 1961, Gedi and Watamu had no potable water supply and Malindi was served from ground water at Ganda. In 1961 an intake/treatment works was constructed on the Sabaki and by 1972 this was the major supply to the area.

In 1983, Malindi was an urban centre and the district headquarters for Kilifi District, Coast Province. Malindi is situated approximately 613km South East of Nairobi. The existing water supply was extracted from Sabaki River. In addition, there were boreholes serving Watamu and nearby areas, and a new scheme was under design. Three boreholes supplied the rural population in Watamu, 22km south of Malindi and 6km long line provided Malindi town with water. The works included in the MUWS programme was completed in 1977 at a total cost of KES 492,000 and included equipping the borehole with electric motors and electric submersible pumps and supply of electricity to the site²⁶⁸.

The Malindi water supply extracted water from Sabaki River through a suction pipe floating on a raft and the silty raw water was pumped to the treatment plant 2km downstream of the intake. After treatment water was lifted by electric pumps to Kisimani reservoir, and gravitated from this point to Malindi town through an 8 inch pipe. The capacity of the treatment works was 2500 m³ per day which was

267 Colony and Protectorate of Kenya (1929-1949). Water Supplies in Kilifi District including Malindi, ref. CA/17/89, Kenya National Archives, Nairobi Kenya.

268 Hunn G (1983). Progress Report About Water Projects included in the Minor Urban Water Supply Programme. NORAD –Coordinator/MOWD. Nairobi Ref: WD/1/2/5. 10th June 1983.

insufficient. The major challenges were related to the reticulation system within Malindi²⁶⁹.

The original proposal for the MUWS programme was to augment the treatment plant at the existing Malindi Water supply. The treatment works lost capacity during flood conditions due to heavy silt load in Sabaki River. It was therefore proposed to build pre-settlement tanks and arrange for new chemical mixing and dosing equipment in order to increase the capacity for the whole year.

The works were carried out but the expenses were not charged to MUWS and the funds were instead utilized for improvement of some boreholes in the area.

A consultant, H.P. Gauff was engaged for the new Malindi water supply which was sponsored by the German Aid. The scheme was designed to extract water from the Sabaki Treatment Works which were also used for supplying to Mombasa. The total estimated cost was KES 118 million by October 1982 and was expected to service the demand of 27000 m³ for a population of 218,000 until 2005. The supply was 50-60% of the demand by 1989 according to Nor Consult evaluation which concluded that the scheme was in a fair condition²⁷⁰.

Voi Water Supply: The pipeline from Mzima springs in Tsavo National Park, to Mombasa, provided Voi with its domestic and industrial water. A 200mm diameter pipe connected to the main Mzima pipeline three Kilometres east of the town fed the supply the town. Close to the take-off point, chlorine was added to the water for disinfection. 90 m³ storage capacity was located in town and this received most of the water, the remainder was fed directly into parts of the distribution system of the town²⁷¹.

Before Mzima Springs Project commissioning in 1956, Voi water supply relied on the following two sources all belonging to the Railway:

- Tsavo Pipeline from Tsavo River.
- Kigalla pipeline from the Taita Hills.

Tsavo supply was directed to 455 m³ 'Military Tank' while the Kigalla supply was directed to the 227 m³ 'Voi' tank by gravity while the former being a pumped

269 Hunn G (1983). Progress Report About water Projects included in the Minor Urban Water Supply Programme. NORAD –Coordinator/MOWD. Nairobi Ref: WD/1/2/5. 10th June 1983.

270 Nor consult A.S (1988). Development of an Integrated Physical/Financial/Socio-Economic Monitoring and Evaluation Programme for Water Supply Schemes, Draft Final Report, Report No. 9. Ministry of Water Development, Republic of Kenya.

271 Waweru and Associates and Rofe Kennard and Lapworth Terrapian Kenya (1980). Third Urban Housing Project Interim Report No. 1 Volume A: The Towns. Republic of Kenya, Ministry of Housing and Urban Development.

supply. Kigalla supply also supplied Samburu area. It was envisaged that with the commissioning of Mzima supply then PWD would undertake the supply²⁷². It is clear that before Mzima and Kigalla schemes, Voi Township was served from Tsavo Pipeline which was put up much earlier.

Samburu Water Supply: In 1910, water in Samburu was supplied from one tank from the station master which contained about 1500 gallons. There were many people and this tank was not enough. The people, who travelled a distance of about 4 miles, were each given one gallon²⁷³. The condition was improved when a consignment of three 9 m³ water tanks was sent to Samburu²⁷⁴.

The district commissioner for Mombasa travelled to Samburu to enquire into water supply. Samburu had three tanks each containing 2000 gallons which was supplied to the natives. The tanks were brought from Voi and were placed in charge of an Indian who had been sent to Samburu by Mr Waller. About 354 natives went for water from the centre. Each of the natives received 2 to 3 gallons free of charge, the ration varied with the size of the vessel brought. At that rate a 2000 gallon tank was enough for two days' supply.

Practically, all the natives who were being relieved were the Waduruma under chief Named Guni²⁷⁵. When the administration started selling water, it was great failure. Less than one water tank was sold and the total number of people coming for water dropped drastically²⁷⁶.

In 1912, once again the natives were short of water after the water holes had dried up. Immediately after the assistant district commissioner, Rabai received the information; a tank was dispatched to Samburu. A trusted government employee was sent to collect fees at six cents per tin. Within fourteen days of water sale, the man was only able to collect KES 0.84. The natives refused to pay for water as on former occasions giving as their reason that the failure of crops during the past year had prevented them from obtaining cash, and continued to make long journeys. They spent about ten hours for the trip. However, the natives of this region could

272 Colony and Protectorate of Kenya (1950-57). Water Supplies Teita District including Taveta, CA/17/108, Kenya National Archives, Nairobi, Kenya.

273 Sigh S (1910). Water Supply for Samburu: Copy of Letter from Santa Sigh, Samburu to the Director of Transport, Mombasa, Kenya National Archives, PC/Coast/1/13/13. 22nd September 1910.

274 Sigh S (1910). Water Supply for Samburu: Copy of Letter from Santa Sigh, Samburu to the Director of Transport, Mombasa, Kenya National Archives, PC/Coast/1/13/13. 26th September 1910.

275 District Commissioner, Mombasa (1910). Scarcity of Water Supply at Samburu. Kenya National Archives, PC/Coast/1/13/13, 27th September 1910.

276 Sigh S (1910). Water Supply for Samburu: A Letter to the Director of Transport, Mombasa, Kenya National Archives, PC/Coast/1/13/13. 21st October 1910.

not move to another part of the country where there were a better water supply and excellent quality of soil for a good crop²⁷⁷.

The acting provincial commissioner made a request for addition of 50 pounds into the public works department estimates for Mombasa province for 1913/14 to cover the cost of two 2000 gallon tanks for Mariakani and Samburu stations. It appeared that every dry season the water holes around the stations failed and the natives depended upon passing railway engines for their water or had to go for a day's journey to draw water from some jungle pool. The railway had before 1912 supplied the administration with 2000 gallon water tanks which were side-tracked to the above station and water sold by the station master at cost price. However, the natives did not buy water at quick enough rate to allow empty tanks to be returned within reasonable time to the traffic department. In addition, since there were no storage reservoirs at either station, the railway tanks had to be returned before they were empty. The acting provincial commissioner suggested construction of the reservoirs²⁷⁸.

In 1913, the Samburu station was thronged by natives begging for water as a result of acute water shortage in the area. Several water holes that used to last dry seasons were dry and about 500 men exclusive of women and children were living in the affected area. The water supply was drawn from a point 16 kilometres away from Samburu Railway Station.

Prior to this period, during drought the railway supplied water in tanks from Voi. At the same time the railway had extended their water pipe to Mackinnon Road and the district commissioner suggested that the railway was supposed to take water to Samburu for natives.

The charge for water was the greatest hardship for the Duruma, whose attitude was epitomized by the remark that water was a gift from god which should not be bought or sold as was the case of meat. The assistant district commissioner suggested a reduction of the rate from six cents²⁷⁹. By December, 1913, there was no water that had been sold. About two hundred natives called at the station to beg for water from the passing train. The assistant district commissioner observed that it was possible to charge a rate of three cents for every four gallons to cover the cost of freight and

277 Assistant district Commissioner, (1912). Water Supply for Samburu. Kenya National Archives, PC/Coast/1/13/13, 22nd August 1912.

278 Tate H.R, (1912). Water Supply for Samburu and Mariakani. Kenya National Archives, PC/Coast/1/13/13, Ref: 998, 20th September 1912.

279 Assistant District Commissioner, Rabai, (1913). Shortage of Water in the Northern Duruma Location. Kenya National Archives, PC/Coast/1/13/13, Ref: 366/11/29, 12th December 1913.

cost of collection. The station master felt that an organized supply delivered daily was likely to increase the number of dependants²⁸⁰.

The Wa Duruma elders at Samburu met with the assistant district commissioner and agreed to collect amongst themselves 33 Rupees (Approximately KES 66) the amount charged by the Uganda Railway for one tank of water. The amount was supposed to be paid to the station master then to the Assistant district Commissioner. Water was ordered from Mombasa which created unnecessary burden on natives who paid nearly three times as much. However, heavy rains fell and water problem reduced significantly²⁸¹. Within a period of almost two months, the Wa Duruma had drawn all the water provided but only able to collect 25 rupees (approximately KES 50).

The drivers of the Railway engines opened their tanks to the natives who collected at the stations of Mariakani, Maji ya Chumvi and Samburu for the purpose of receiving water. Usually about 200 women gathered at one station and fight 'fat and furiously' for water since the train halted only for short time. The assistant district commissioner observed that as long as there was free distribution of water it was impossible to think of collection of money. He recommended that the free distribution was better sanctioned and increased or forbidden altogether and tanks delivered at intervals at those stations where they were required. It was also dangerous fighting for water around a moving engine. The commissioner notes that the distribution of water was antagonistic to the settlers' general administrative policy that was, drawing the natives together and so brings them under more effective administrative.

The assistant district officer interpreted drought as an opportunity for effecting the object without the intervention of force, but as long as water was supplied to the natives, they were likely to remain inaccessible to the settler. He notes

“The natives were likely to remain in remote parts of the bush living a life a kin to that of animals than human beings and playing no part direct or indirect in the advancement of the protectorate²⁸²”.

The commissioner contended that he was inhuman but explained:

280 Assistant District Commissioner, Rabai, (1913). Shortage of Water in the Northern Duruma Location. Kenya National Archives, PC/Coast/1/13/13, Ref: 374/11/29. 20th December 1913.

281 Assistant District Commissioner, Rabai, (1914). Shortage of Water in the Northern Duruma Location. Kenya National Archives, PC/Coast/1/13/13, Ref: 392/11/29. 6th January 1914.

282 Champion A.M (1914). Water Supply: Duruma Location. Kenya National Archives, PC/Coast/1/13/13, Ref: 7/11/29. 23rd February 1914.

“couldn’t be otherwise in order to take advantage of the forces of nature when helpful to the settlers’ policy”

He instructed the station master to stop drivers from giving water until the arrears were paid up²⁸³.

In his contribution on the issue, the provincial Commissioner, Mombasa, directed that money for water meant for natives was supposed to be paid in advance and deposited with the assistant district commissioner. He prohibited water supply to natives from a locomotive noting that in case of an accident by a locomotive, the Wanyika were likely to claim blood money from the government²⁸⁴.

Tsavo Water Supply: This supply was put in place in 1898 just as the construction of the Uganda Railway reached this place. In his book, ‘The Man-Eaters of Tsavo’, Patterson (1907), who was the Divisional Engineer on the construction of the railway, narrates how the Tsavo Bridge was constructed and dangers poised and damages wreaked by the two Man-Eating lions. More astoundingly he somehow gives information on a water supply for the place as suggested by this extract

”Then, also, a water supply had to be established; and this meant some very pleasant work for me in taking levels up the banks of the river under the cool shade of the palms. While doing this, I often took my camp-kit with me, and a luncheon served in the wilds, with occasionally a friend to share it- when a friend was available- was delightful.

On one occasion in particular, I went a long way up the river and was accompanied by a young member of my staff. The day had been exceedingly hot and we were both correspondingly tired when our work was finished, so my companion suggested that we should build a raft and float downstream home”.

Furthermore at the peak of the Man-Eating spree by the two savage lions, Patterson notes

”It was strange and amusing sight to see these shelters perched on the top of water tanks, roofs and girders- anywhere for safety- while some even went so far as to dig

283 Champion A.M (1914). Water Supply: Duruma Location. Kenya National Archives, PC/Coast/1/13/13, Ref: 7/11/29. 23rd February 1914.

284 Provincial Commissioner, Mombasa (1914). Supply of Water during Drought to Natives of Samburu and Mariakani Kenya National Archives, PC/Coast/1/13/13, Ref: 256/2. 27th February 1914.

pits inside their tents, into which they descended at night, covering the top over with heavy logs of wood”.

Makindu Water Supply: This water supply was developed before 1905 by the Uganda Railway for the watering of their locomotives. However, other institutions like the hospital became beneficiaries. The following extracts from correspondences testify to this fact.

Medical Department 30th November 1916 wrote to the District Engineer of the Railway²⁸⁵:

“I have the honour to inform you that I have been led to understand that the water supply to Makindu dispensary is not altogether satisfactory owing, I gather, to other taps being on the same pipe line. I should feel grateful if you would kindly cause this matter to be inquired into and any defects, which may exist, remedied”

The principal medical officer to District Engineer on 21st March 1917:

“I beg to inform you that I have given instructions to have the pipeline to the Hospital re-laid and hope there will be no further trouble. It is connected direct to the service tank and being of small bore gets choked readily with weed. Will you kindly instruct your SAS to report at once to the Permanent way Inspector Makindu of any stoppage of the supply?”

General Manager Uganda Railway 21st April 1915 to Attorney General, Nairobi noted that

”I have the honour to inform you that the site of the Makindu station was selected by the railway mainly on account of the Makindu River, on which the railway is entirely dependent for its supply of water for running purposes”.

For several years from the time of the opening of the station no difficulty was experienced in obtaining a sufficient supply from the stream. In the year 1905 Messrs Premji and Co who had received grants of land along this river, applied for permission to divert the stream with the purpose of irrigating their farm. The land officer declined to grant the permission, as the whole of the flow was needed to meet the requirements of Makindu. But in spite of the refusal and repeated notices to desist the lessees have

285 British East Africa Protectorate (1915-17). Uganda Railway, Water Supply Makindu, AG/43/02 Kenya National Archives, Nairobi, Kenya.

been diverting the streams and irrigating their farms every year during the dry season, to the most serious detriment of the continuance of traffic on the railway.

On various occasions attempts have been made to take action to restrain the parties, but they appear to have always successfully waved the question by asking for time to communicate with the principals who, it was stated, had assigned their interests to others, by which time the rains having broken they had desisted from irrigating.

Mwatate Water Supply: Mwatate was the divisional headquarters of Taita district in coast province. The rural centre is situated 37km west of Voi and 375km south east of Nairobi.

There was an existing county council water supply that abstracted water from Movorenyi River, which was a tributary of Mwatate River. The intake was 6km upstream of the township, and water was supplied by gravity. The existing capacity was 200 m³ per day and was insufficient. The original intention was to retain some parts of the existing scheme and to build a new intake at Voi River. The cost estimate was KES 0.4 Million in 1973 and KES 1.2 million in 1977²⁸⁶.

A Consultant, Ward, Ashcroft and Parkman, was engaged for design and supervision of Mwatate MUWS in July 1975. The population growth and water demand projections. These are illustrated in Table 3.13

Table 3.13: Population growth and water demand projections for Mwatate

Year	1980	2000
Population	6,330	11,100
Water demand (m ³ per day)	300	680

The boreholes were drilled and test pumped by ministry of water. It was found that the yield was insufficient and that the water was saline and the consultant was therefore requested to find an alternative surface water source. In addition, the consultant was to prepare a design report including the rural areas west of Mwatate. The supply areas were consequently increased to 65km² and the cost of works was roughly estimated at KES 50 million. An estimated cost of the dam was KES 20 million while a 7km 6 inch trunk main, distribution net and storage tanks was estimated to cost KES 30 million. The revised preliminary design was expected in 1983²⁸⁷.

286 Hunn G (1983). Progress Report About Water Projects included in the Minor Urban Water Supply Programme. NORAD –Coordinator/MOWD. Nairobi Ref: WD/1/2/5. 10th June 1983.

287 Hunn G (1983). Progress Report About Water Projects included in the Minor Urban Water Supply Programme. NORAD –Coordinator/MOWD. Nairobi Ref: WD/1/2/5. 10th June 1983.

With a supply area of 65km², the project became a rural supply rather than a small urban water supply as originally intended. It was recommended that NORAD agreed to finance the design of Mwatate MUWS and also consider financing construction of the project provided that the area of supply is reduced and the estimated cost of construction was less than KES 20 million. The construction works could easily be undertaken by direct labour section if the dam was avoided.

Wundanyi Water Supply Project: Wundanyi was a rural centre and district headquarters for Taita district, Coast Province in 1983. The existing water supply was completely a gravity project (figure 3.15) and the old intake at Wesu had been retained without changes. The augmentation included extension of the treatment works, construction of staff house and new break pressure tank and laying various pipelines.



Figure 3.15: Wundanyi water project 1983²⁸⁸

The MUWS-project involved augmentation of the existing scheme, and construction of Phase 1 of a completely new project at Wundanyi. Ward, Ashcraft and Parkman were the consultants and Mvita Construction Company was the Civil Contractor. A total of KES 9.2 million was required for the completion of the MUWS projects.

Taveta Township Water Supply: Taveta Township in 1914 had water holes on the Voi-Taveta Road between Burra and the Lumi River a distance of 66 kilometres. The administration decided to improve this form of water supply by building

288 Hunn G (1983). Progress Report About Water Projects included in the Minor Urban Water Supply Programme. NORAD –Coordinator/MOWD. Nairobi Ref: WD/1/2/5. 10th June 1983.

tanks to collect the surface rainfall (run-off) from three different places. They also considered an earth dam in the valley of the Lanjoro water course necessary. It was further suggested that the tanks had to have a wall round them to prevent their pollution by wild game²⁸⁹.

The Governor on 25th May 1911 to the Director of Public Works, through Acting Secretary, wrote the following concerning a water supply for Taveta:

“When I was at Taveta I looked into the question of the water supply there which is rather a difficulty at present. I think it quite practicable to put in a water furrow from the river, which would run past the station and could be utilised for irrigation as well as water supply. Mr. Brett, the A.D.C., is quite capable of putting in this furrow if he can be provided with a level and staff. I have suggested to Mr. Hinde that 20 prisoners should be sent up in this dry weather to do the work under Mr. Brett’s supervision. Could you furnish the level and staff?”²⁹⁰

The provincial commissioner Mombasa on June 7th 1911 to the Assistant District Commissioner Taveta, through the District Commissioner Voi, was informing the latter that in accordance with the Governor’s orders the former was preparing to send 20 prisoners to work at a furrow as suggested by His Excellency the Governor to the latter personally. As soon as the Assistant District Commissioner arranged for their accommodation and the dry weather had set in the prisoners would be forwarded. Indeed the Provincial Commissioner noted that His Excellency had sent a level and a staff to the District Commissioner Voi²⁹¹. The level was identified as a Stanley Level with a tripod stand.

The Assistant District Commissioner Taveta in his letter of 28th July 1914 to the Acting Provincial Commissioner Mombasa on ‘water from River Lumi for Taveta Station’ indicated the following:

“As requested by your minute in reply to my letter of the 23rd May on the above subject, I have the honour to forward herewith a sketch showing the relative position of the station, mission and the River Lumi. I estimate the total distance along which the furrow should be carried as about six kilometres. To carry out the work by means of station hands is a matter of some difficulty as the station hands

289 British East Africa Protectorate, (1914) Taveta Water from the Lumi River, Ref. PC/Coast/ 1/14/57, Kenya National Archives, Nairobi, Kenya.

290 British East Africa Protectorate, (1911) Taveta Water Supply, Ref. PC/Coast/ 1/15/133, Kenya National Archives, Nairobi, Kenya.

291 British East Africa Protectorate, (1911) Taveta Water Supply, Ref. PC/Coast/ 1/15/133, Kenya National Archives, Nairobi, Kenya.

vote is only Rs 300 (approximately KES 600) and to ensure completion it will be necessary to draw on the Local Travelling vote some Rs 1000 (approximately KES 2000) of which still remain unexpanded.

If no additional funds are forthcoming I shall endeavour to carry on the work with money at my disposal, as the advantages of having water near the station are palpable. At present much of the time of the station hands is expended on bringing water from the Lumi River to the station, a distance of three kilometres. Moreover no steps can be taken towards the making of an experimental shamba until water has been brought to the vicinity of the boma, as I am too busily occupied at the station during office hours to be able to supervise work some distance away.

I agree with you that it is advisable to remain independent of the CMS mission, though the authorities have expressed no objection to the mission furrow being tapped for Government purposes only”.

On 23rd May 1914 the Assistant District Commissioner Taveta wrote the following to the Provincial Commissioner Mombasa on Taveta water supply:

“I have the honour to enquire whether it would be possible for £30 to be set aside out of one of the votes of this year, for the purpose of bringing water from the Lumi River to within easy reach of the station i.e. a couple of yards.

The advantages are so patent they hardly need enumeration. But apart from the convenience of having water in the immediate vicinity, it would enable me to start an experimental shamba on a large scale for the planting of economic products with a view to instructing the inhabitants of this sub-district in this desirable industry, and at the same time be independent of the rainfall, the irregularity and the paucity of which is at present an obstacle to any success in this direction.

I have examined the intervening country today and am convinced that £30 would cover the expense and possibly it could be done for considerably less. If the money cannot be made available I would suggest the following less expensive alternative. I examined today the point on the River Lumi from which the Mission stream starts. A regular cataract of water is discharged into the channel sufficient to keep a whole town supplied with water, but owing to the insufficient depth and inadequate banking of the channel the water is scattered over the surrounding country, until when it reaches the mission it is little more than a trickle. I propose that an arrangement be made with the mission by which the expense of increasing the depth of the channel and the repairing of the banks be borne by the Govern-

ment; and in return for the retention of the vast volume of water thus effected, the Government be allowed to tap the stream at the point nearest to the station.

15 pounds would be sufficient for this work; and the advantages to both Government and Mission would be incalculable. At present a very considerable waste of water is going on, and I am making representations to Mr. Verbi on the subject”²⁹².

The DO, Taveta, J.A.C. Reed, writing to the DC Taita District on 9th Nov. 1955 noted that,

“there is plenty water at Taveta, but, as you know, the present system is by tapping the E.A.R and H. water supply. If other buildings are to be erected I consider that a borehole should be sunk for boma use’. It is not clear when the Railway supply was installed”²⁹³.

3.3.2.2 Nyanza Province Water Supplies

Kisii Water Supply: In 1983, Kisii was a municipality and the district headquarters for Kisii district. Kisii is situated 372km North West of Nairobi in an area of relatively high rainfall (1500 to 2000mm/year)²⁹⁴.

Before 1934, Kisii Township obtained water from water carriers, mainly prisoners who served government institutions. In the Bazaar, businessmen employed their own water carriers using small hand barrows or their heads from the Nyasara River in the valley. The medical department noted that in most cases the carriers fingers would be dipped into the water and the health risks of amoebiasis were high. The water supply to the hospital was also a health hazard since it was obtained from springs, rainwater tanks and a furrow leading to the hospital supplying water for washing, bathing, and cleaning of kitchen utensils. The furrow was about five kilometres in length and was open to all forms of pollution. Rainwater stored in tanks was another source of supply²⁹⁵.

Water supply in the European houses was fifty percent rainwater and the remaining fetched in pails from springs by natives. At the Asiatic Bazaar, ten percent was

292 British East Africa Protectorate, (1914) Taveta Water from the Lumi River, Ref. PC/Coast/ 1/14/57, Kenya National Archives, Nairobi, Kenya.

293 Colony and Protectorate of Kenya, (1950-57) Water Supplies Teita District including Taveta, CA/17/108, Kenya National Archives, Nairobi, Kenya.

294 Hunn G. (1983). Progress Report about Water Projects Included in the Minor Urban Water Supply Programme. NORAD, Nairobi.

295 Colony and Protectorate of Kenya (1935). The Official Gazette, 25 June 1935. Kenya National Archives, Ref: AG/43/79.

rainwater and ninety percent from springs. Natives drew their water from springs and small springs running on each side of the township. These water sources were liable to be infected with amoebiasis.

The diseases were spread by means of flies and to reduce this, adequate latrine accommodation was recommended. Consequently, more supervision and efforts were put to improve the water supply and quality²⁹⁶.

Nyakomisaro water supply: A piped water supply for Kisii Township was proposed as early as 1932 by the acting Hydrographic Surveyor. A report by the Inspector of Water Supply, Mr J.E. Collins, indicated that total daily demand was 6,240 gallons and 11,500 gallons per day in future, the proposed intake river had 0.15 cusecs per day and it was possible to use a gravitation main²⁹⁷. The intake work was proposed in an area approximately 3.5 kms from Kisii Town.

The construction of Nyakomisaro water supply was started in 1932 and comprised of an intake, clarifiers, filters and clear water tanks²⁹⁸. The supply was fed through the gravity. All connections were proposed to be metered and the Government institutions included, Local Native Council School, Native Civil Hospital, H.M. Prison, tribal retainers and police lines. These were served at an estimated capital expenditure was estimated at £2,460²⁹⁹.

The treatment plant constructed in 1937 was extended in 1967 and completed in 1977 at a capacity of 1000m³ per day by 1983. A borehole within the treatment plant areas supplied the water required for backwashing the rapid sand filters. Most of the reticulation system consisted of pipes with dimension of 3 inch and 4 inch and the total storage capacity was 682 m³. The treatment plant by 1983 was in full operation but was anticipated that it would be closed down by 1995³⁰⁰. By the year 2004, though seen as old, the supply was operating at an output of approximately 250m³/day due to the limited capacities of the, alum dosing/mixing chamber, decanting pipes and outlet channel of the sedimentation tanks, filter media and lack of backwashing facilities and existing transmission pipes (80mm, 100mm and 150mm)³⁰¹.

296 Kisii Native Hospital, (1935). Memorandum on Health of Kisii Township. Kenya National Archives, BY/29/38. 27th March 1935.

297 Kenya Colony and Protectorate (1942-1947). Local Land Board Minute 9/36 Assented by C. CLTB 2/86 of 18/11/1936. Kenya National Archives. CA/13/39. 1st October 1945.

298 UN-HABITAT PROJECT (2004). Kisii Municipality: Lake Victoria Region Water and Sanitation Infrastructure Rehabilitation Programme, Town Summary Report, 10th August 2004.

299 Kenya Colony and Protectorate (1942-1947). Local Land Board Minute 9/36 Assented by C. CLTB 2/86 of 18/11/1936. Kenya National Archives. CA/13/39. 1st October 1945.

300 Hunn G (1983). Progress Report about Water Projects Included in the Minor Urban Water Supply Programme. NORAD, Nairobi.

301 Kenya Colony and Protectorate (1942-1947). Local Land Board Minute 9/36 Assented by C. CLTB 2/86 of 18/11/1936. Kenya National Archives. CA/13/39. 1st October 1945.

Kegati water supply: In 1957, designs and estimates were prepared for a second intake from the Gucha River, Kegati water supply. The Kegati works were constructed in mid 1970s and comprised an intake, pump house, clarifiers, filters and clear water tanks with a design capacity of 6,000m³/day. Unlike, Nyakomisaro, Kegati supply distributed water through pumping. The works were located on Gucha River approximately 8.5km from the Kisii town centre. It was rehabilitated in 198 and again in the year 2000 under the El Nino Project when most of the faulty equipment like pumps were replaced. The works had a design capacity of 6,000 m³/day but by the year 2004 supply a capacity of 4,000 m³/day³⁰².

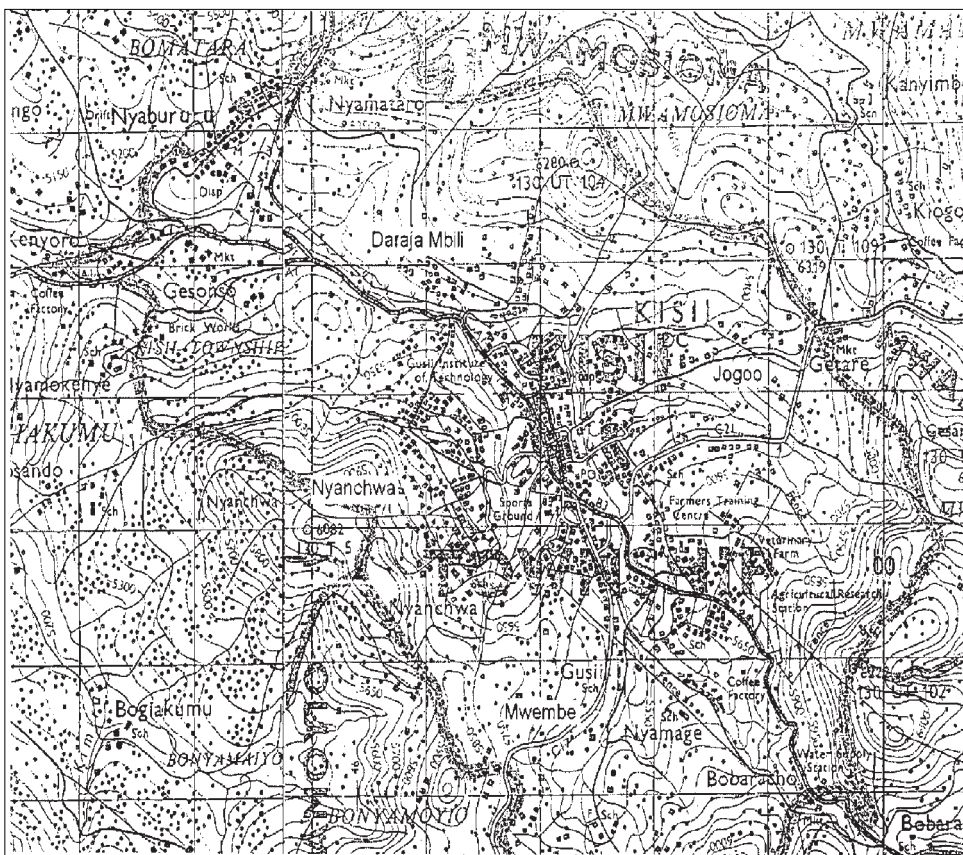

Figure 3.16: Map location of Kisii municipality³⁰³

302 UN-HABITAT (2004). Lake Victoria region Water and Sanitation Infrastructure Rehabilitation programme: Town Summary Report: Kisii Municipality. August 2004 Issue.

303 Wanjau D.M (2004). Kisii Municipality: Lake Victoria Region Water and Sanitation Infrastructure Rehabilitation Programme- Survey Carried Out in June 3-4, 2004

The existing Kisii water was inadequate and a consultant TAMS was engaged in Kisii-Sameta-Manga combined water supply. The part of large scheme serving Kisii town was included in Phase 1 of the project, and this phase was included in MUWS—programme finance by NORAD. Kisii water supply was commissioned by in august 1977 and total cost of Construction was KES 17.6 million. Various sources were studied for supplying this big scheme and the Gucha River was finally selected. The scheme was therefore complicated.

The population growth rate and the water demand were projected as shown in Table 3.14. By 1995, the water demand was revised to 12000 m³ per day

Table 3.14: Population and water demand projections

Year	1975	1985	1995
Population			
Kisii	9000	20000	40000
Sameta	57500	77200	87000
Water demand (m³)			
Kisii	320	2545	7275
Sameta	320	2047	5350
Manga	2047	1897	4324
Total	4264	8992	16949

The operation, maintenance and marketing of water within the actual town boundary were handed over to the municipality at the end of 1982. Kisii municipality bought the water in bulk from MoWD. As a result the following challenges were experienced.

Although the distribution lines within the township were augmented in 1976, there were frequent problems of shortage in some areas. As more houses were and consequent increased consumers, the capacity became inadequate.

At the entrance of the town, there was an area where frequent pipe bursts occurred, on average twice a month. According to the drawings, the maximum water pressure was approximately equal to the maximum working pressure of the pipe class described. The most likely causes were pipe material being not up to the specification, poor workmanship when pipes were being laid and pipes being near the main road therefore being damaged by vibrations from the heavy vehicles³⁰⁴.

304 Hunn G (1983). Progress Report About Water Projects included in the Minor Urban Water Supply Programme. NORAD –Coordinator/MOWD. Nairobi Ref: WD/1/2/5. 10th June 1983.

The treatment works were generally in good condition however, there were fault valve extensions for the filters, chemical pumps were not functional, and the stand by generator was not in good working order³⁰⁵.

Manga water supply, was in phase III of the combined project, was also included in the Rural Water Supply III programme, however, there was no sponsor by 1983. By 1989, the general condition of the supply was fair as per evaluations of Nor Consult. However, some shortages were reported³⁰⁶.

Nyamira Water Supply: Nyamira water supply was under construction in 1957. An inspection report of the Senior Water Engineer of an inspection carried between 10th-16th June 1957 and dated 19th June 1957 showed that the scheme was under construction. The site was visited on 12th June. Work had been delayed by pressure of work at Kisii, and although the stores were on site, only some trench excavation had been undertaken. After a visit to the nearby trading centre, an eye check suggested a gravity supply to the kiosk was possible³⁰⁷.

Victoria Nyanza (Miwani) Sugar Company Limited Water Supply: By 1923, there were 667 native Kavirondo employed in the company. Out of these 160 mill hands, semi-skilled, were employed within the factory, 254 field hands cultivated, cut and loaded the cane and 110 were ox drivers. There were also a number of women and children not living in the premises. Water supply was derived from springs³⁰⁸. Water supply was taken from the river at the foot of the escarpment and conveyed to the factory through a cement furrow to a cement reservoir. This water was then used for boiler purposes and all process of sugar manufacture. It was the supply for large mill camp adjoining the factory. The European supply was drawn from a spring some distance behind the European quarters and it was impounded by in a 4546 cubic metres cement reservoir and from there piped to various quarters³⁰⁹.

By 1955, there were four main labour camps including the factory camp. In all these camps except the factory camp, the standard of housing was under gradual improvement through a definite programme for improvement inspected by the provincial labour officer. Water supply at the factory camp was supplied by the

305 Hunn G (1983). Progress Report About Water Projects included in the Minor Urban Water Supply Programme. NORAD –Coordinator/MOWD. Nairobi Ref: WD/1/2/5. 10th June 1983.

306 Nor consult A.S. (1988). Development of an Integrated Physical/Financial/Socio-Economic Monitoring and Evaluation Programme for Water Supply Schemes, Draft Final Report, Report No. 9. Ministry of Water Development, Republic of Kenya.

307 Colony and protectorate of Kenya (1951-1960). Hydraulic Inspection Reports, BV/138/19, Kenya National Archives, Nairobi, Kenya.

308 Labour Inspector (1923). Inspection of Labour Camps Report. Kenya National Archives, BY/62/4. 20th March 1923.

309 Sanitary Inspector (1923). Miwani. Kenya National Archives, BY/62/4. 19th March 1923.

Miwani Factory Mains Supply while in section 1, 2, and 3 camps it was obtained from the rivers nearby³¹⁰.

Port Victoria Water Supply: Port Victoria was a market centre located on the shore of lake Victoria in Busia district, western province. The centre is 145km west of Kisumu and 525 km North West of Nairobi. In 1983, there was no gazetted water supply in Port Victoria. The MUWS for Port Victoria was designed by the Ministry's Departmental design section and constructed by direct labour section. Port Victoria water supply was officially commissioned in 1977 at a cost of KES 1.365 million. The population growth and water demand projections are as shown in Table 3.15.

Table 3.15: Population growth and water demand projections in Port Victoria

Year	1975	1985	1995
Population	4350	5800	7850
Water demand (m ³ per day)	60	276	600

The water project supplied both the market centre and 12km² of the surrounding area. The scheme comprised of an intake well and 50m long 4 inch galvanized steel suction pipe in the lake, two submersible pumps, 300m raw water suction line with 4 inch diameter, pumping house with two diesel driven generating sets and two high lift pumps (figure 3.17), 50 m³ clear water storage tank complete with chlorination equipment and two storage tanks with 90 m³ and 45 m³ capacities.

Operational problems included poor repair and maintenance process done diesel generating set not functioning for months frequent problems with lack of fuel and all the pumps were operated manually since the automated systems had stopped functioning. Port Victoria water supply was a small, simple and economical project which had proved to be rather success. It was concluded that it was not necessary for NORAD to take any augmentation works.

310 District Health Inspector, Central Nyanza (1958). Sugar Irrigation Scheme – Miwani. Kenya National Archives, BY/62/4, Ref: SA/1/58/153. 10th December 1958.



Figure 3.17: High lift pump worked satisfactorily although poorly installed by 1983³¹¹

Homa Bay Water Supply: Homa Bay was an urban centre and the district headquarters for South Nyanza District, Nyanza province. It is located 1240 metres above sea level at the shore of Lake Victoria. The station was opened in 1958 as an administrative station and immediately the question of water supply arose. A water supply without treatment works was contemplated to be laid in 1958. The scheme consisted of raw water intake and raw water pumping station, treatment unit with two vertical flow sedimentation units and two rapid sand filter units, capacity of 360 m³ per day, high lift pumping station storage tanks and pipelines. Water at Homa Bay was grossly polluted even to the naked eye³¹². Due to lack of technical capacity, damaged machinery (figure 3.18) was difficult to repair and delayed water works or provision of water to the consumers sometimes for months.

311 Hunn G (1983). Progress Report about Water Projects Included in the Minor Urban Water Supply Programme. NORAD, Nairobi.

312 Hunn G (1983). Progress Report about Water Projects Included in the Minor Urban Water Supply Programme. NORAD, Nairobi.

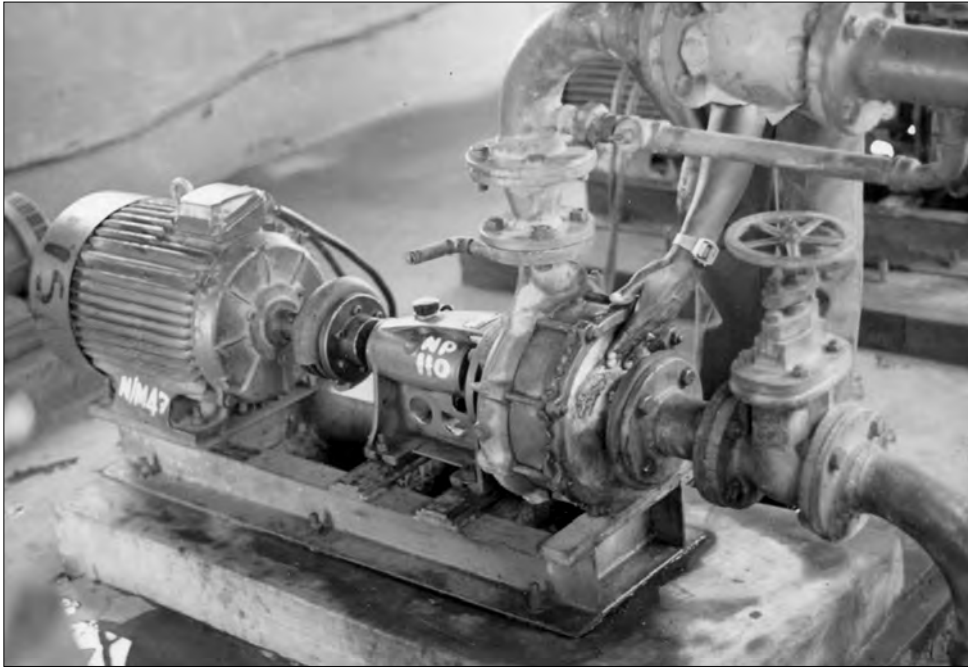

Figure 3.18: A damaged high-lift centrifugal pumping at Homabay by 1983³¹³

The first augmentation plant with a vertical flow sedimentation and two rapid sand filters was put up in 1967/68. The capacity of the treatment works was increased from 360 m³ per day to 790 m³ per day. At the same time, electrification of all pumping units was done, and the limit of supply was extended to include the Ogande Girls Secondary school. A booster station had to be built at the storage tank site to supply this school. Another new 90 m³ pump equipped with submersible pump, which lifted the water to a steel storage tank on the Asego Hill was also included.

The second augmentation was carried out between 1976 and 1980 and included a new water intake and a raw water pumping station. A new 1720m long raw water rising main with 200 mm diameter was constructed. Augmentation of the existing treatment works by adding a horizontal flow sedimentation basin and a rapid sand filter unit and increased the capacity of the treatment works to 1800 m³ per day. An additional 1650m long rising main, a 225 m³ storage tank and two standby generators installed³¹⁴. The second augmentation was commissioned in 10th June 1980 and the total cost of construction was KES 2.927 million. The extension

313 Hunn G (1983). Progress Report about Water Projects Included in the Minor Urban Water Supply Programme. NORAD, Nairobi.

314 Hunn G (1983). Progress Report about Water Projects Included in the Minor Urban Water Supply Programme. NORAD, Nairobi.

of the water works was based on the following population and water demand as it accelerated with years (Table 3.16).

Table 3.16: Water demand in Homabay between 1977 and 1997

Year	Persons	Per capita demand (lppd)	Water demand (m ³ per day)
1977	5200	1451	750
1987	9300	1451	1350
1992	12400	1451	1800
1997	16700	1451	2400

The augmented water works had a capacity of 1800 m³ per day therefore another augmentation was required by 1993.

Operation of the augmented scheme: Although the augmentations had improved the water supply significantly, there were still frequent complaints about shortage of water. The complaints were about the poor quality of the high lift pumps which had broken down several times and lack of repair. The treatment works were extremely difficult to operate due to many interconnections between the original plant and the two extensions. Some parts of reticulation system were very old (25 years) and could not cope with the increased flow. Only the original town area of 2.5km² was by 1983 supplied with water. All the sub-urban development was not supplied. The estimated average production of water was between 1245 and 1385 m³ per day based on the annual production³¹⁵.

By 1989, the scheme was under rehabilitation to improve the supply and meet demand³¹⁶.

Rongo Water Supply: Rongo was a small market centre in South Nyanza District. The centre is located about 25km south west of Kisii on the Kisii Migori Road. Rongo water supply was constructed by direct labour section and was commissioned in June 1980. It covered a supply area of 4.2km² drawing water from Masadhi River. The capacity of the treatment works was 580 m³ per day. It had a 100 m³ storage tank and had pipe lines of a total length of 10.6km with 50mm and 150mm dimensions. After 34 months of operations, one generator was out of order for two years without repair; there was an average of 3 to 4 pipe bursts per month in the distribution system. The storage and backwash tanks were not fenced. A mixing

315 Hunn G (1983). Progress Report about Water Projects Included in the Minor Urban Water Supply Programme. NORAD, Nairobi.

316 Nor consult A.S (1988). Development of an Integrated Physical/Financial/Socio-Economic Monitoring and Evaluation Programme for Water Supply Schemes, Draft Final Report, Report No. 9. Ministry of Water Development, Republic of Kenya.

chamber in Rongo is demonstrated in Figure 3.19, while Table 3.17 illustrates other operational details.



Figure 3.19: Mixing chamber in Rongo³¹⁷

It was therefore clear that despite availability of fuel, water production did not satisfy the water demand. The scheme produced on 11 percent of the annual water demand not taking into account the huge losses of water due to pipe bursts. Further, it was established that the cost of running the scheme with diesel fuel was more than two times running the scheme with electricity at KES 346,540 and KES 161,200 per year respectively. It was recommended that the cause for frequent pipe bursts be established and rectified, electrification of the project was also recommended and NORAD was recommended to provide KES 800,000 shillings for augmentation of Rongo Water Supply.

³¹⁷ Hunn G (1983). Progress Report about Water Projects Included in the Minor Urban Water Supply Programme. NORAD, Nairobi.

Table 3.17: Other operational details

Operational issue	Operational measure
Daily water production when scheme is operational (m ³)	94 (designed 225 m ³)
Days water supply was operational per year	101
Annual fuel consumption (litres)	4005
Capacity of treatment works (m ³ per hour)	17 (designed 20 m ³)
Annual running hours of treatment plant (hours)	556
Annual water production (m ³)	9366 (designed 82125 m ³)
Number of pipe bursts per year (m ³)	34
Amount of water lost due to pipe bursts (m ³ estimate)	3400

Migori Water Supply: This supply was constructed in 1957. An inspection report of the Senior Water Engineer of an inspection carried between 10th-16th June 1957 and dated 19th June 1957 showed that the scheme was under construction and it was a two-borehole supply. The supervision of the works was under an African Engineering Assistant. The pump house foundations were inspected and site arrangements for block making, steel bending and stores were examined and to the Engineer, the progress was satisfactory with good workmanship³¹⁸.

Siaya Water Supply: Siaya water supply was located in Siaya town, the headquarters of Nyanza province. The supply was a pumping scheme with its source from an impounding earth dam. It was an old water supply, which was commissioned way back in 1952. It had a supply area of 23km² serving approximately 45000 people. The scheme produced 600 m³/day through 10 hours of daily pumping by 2001.

The operation and maintenance of the scheme was managed by the National Water Conservation and Pipeline Corporation (NWCPC). Water transmission was both by pumping and gravity. The scheme had a total storage capacity of 315 m³/day. It had a distribution network of 37.8km. The rising/gravity mains had a length of 1.07 km. The treatment consisted of a sedimentation basin, 2 rapid filters, and one clear water tank with a chlorine solution tank. The intake works consisted of 4 low lift pumps and 4 high lift pumps all in two pump houses. Treatment involved coagulation, filtration, chlorination and pH control³¹⁹.

318 Colony and protectorate of Kenya, (1951-1960). Hydraulic Inspection Reports, BV/138/19, Kenya National Archives, Nairobi, Kenya.

319 The World Bank WSP – EASA (2001). The Development of the National Policy on Environmental Sanitation and Hygiene: A Situation Analysis on the Legal, Institutional and Resource Mobilization Frameworks Affecting the Environmental Sanitation and Hygiene (ESH) Sub-Sector in Kenya. Draft report.

Bondo Water Supply: Bondo station owes its origin to the siting of police station around 1936. The water supply for the station was carried by means of two donkeys and a water porter. One donkey was able to carry eight to ten gallons (36 – 45 litres) per load. By 1954, animals were still the means of water supply. A letter from the Divisional Headquarters of Kenya Police, Kisumu to the DC Central Nyanza reads as follows:

“As one of the oxen died at Bondo the police personnel at Bondo are unable to draw water for their use by means of ox cart. I shall be grateful if arrangements could be made with the A.D.C. truck to bring water for police, when it goes for A.D.C. water, as well”³²⁰.

In 1957 a supply for Bondo was under construction. A site visit by the Senior Water Engineer on June of this year shows that the treatments works were sighted far from the village and access was by a poor track. An Asian Foreman was resident on site³²¹.

In 1965 the supply was extended to cover Maranda and Nyamira areas.

3.3.2.3 Rift Valley Province Water Supplies

Naivasha Water Supply: In December 1903, Currie, the manager Uganda Railways, recognized an impending problem when settlers started taking up land along the Njoro River. He therefore sought in advance, from his letter to the Land officer, the reservation of the rights of the railway to all watering stations on the railway line. This apprehension over the water rights arose from the fact the settlers would inevitably draw water from the Njoro River for irrigation purposes, a situation which would deprive not only the railway station and its locomotives of water but also the greater Nakuru township at large. This state of affairs was especially aggravated by the fact that water Volume in the Njoro River was critical during the dry seasons³²².

In 1904, the Land Officer Mr Hobley, Naivasha, sought redemption to the contemplated conflict. He suggested that it be put in the official gazette a notice to warn the intending settler that no diversion of the Njoro River or any of its feeders above the Railway Dam would be allowed nor could any water be drawn off above

320 Colony and protectorate of Kenya (1933-1956). Bondo Police Station, DC/KSM/1/24/23, Kenya National Archives, Nairobi, Kenya.

321 Colony and protectorate of Kenya (1951-1960). Hydraulic Inspection Reports, BV/138/19, Kenya National Archives, Nairobi, Kenya.

322 Williams G.B (1907). Report on the Sanitation of Nairobi and Report on the Townships of Naivasha, Nakuru, and Kisumu. Kenya National Archives, GP, 363.7.BRI. 1907.

the said dam for irrigation. It was also suggested that a clause to this effect be inserted in the settlers lease.

The township of Naivasha is situated on the East Side of Lake Naivasha and as at 1907, it served as the headquarters of the then Naivasha Province. The town is 89km North West of Nairobi. The population of Naivasha in 1907 was 300 persons.

Lake Naivasha is one of series of Lakes on the bottom of the Rift Valley. In 1907, it had a superficial area of 80 square miles (207 km²). Only two rivers feed the lake i.e. Gilgil and Morendat. The lake has no outlet river. Behind the lake are the walls of the Rift Valley in a series of escarpments up to the Aberdare range and the Kinangop Mountains, with a height of 13,000ft.

In 1907, Naivasha consisted chiefly of government buildings. The Boma, a fortified enclosure surrounded by a stone wall and a moat contained government offices, which were in a row of white plastered stone buildings, a storeroom, the post office, and two official bungalows made of mud and stones with thatched roofs. The sub-commissioners house was built on the edge of the cliff overlooking the lake. Behind the Boma was the hospital, consisting of a few small stone huts with a store and a dispensary. This very area also housed the prison very roughly constructed of mud and stones. The police lines were a collection of mud and stone houses higher up in the hill. There was also the collectors' house, the clerk's quarters and the permanent way inspectors' house. The public works had a yard and office near the railway. Besides official government houses there were three private buildings, the Rift Valley hotel and two shops owned by Indian traders, all of them built of wood and corrugated iron³²³.

The drinking water supply for Naivasha Township in 1907 was obtained chiefly from iron tanks, which caught rainwater from roofs of the houses. Water for other purposes was obtained from the lake and carried in Kerosene tins fastened on the backs of donkeys. A boat was used in fetching the water about one kilometre off-shore to obtain the water. William, in his 1907 study of Nairobi, Nakuru, Naivasha and Kisumu, discerned that the lake water was also largely being used for drinking purpose. The rainwater tanks were too small to provide for the drinking water requirement for the population throughout the year. The Engineer had in the meantime proposed the construction of concrete tanks 300 litres in size each house and some private individuals had already arranged for their own water³²⁴.

William proposed several possible water schemes for Naivasha; one involving either pumping or gravitation from Morendat river, the second involving pumping

323 Williams G.B (1907). Report on the Sanitation of Nairobi and Report on the Townships of Naivasha, Nakuru, and Kisumu. Kenya National Archives, GP, 363.7.BRI. 1907.

324 Williams G.B (1907). Report on the Sanitation of Nairobi and Report on the Townships of Naivasha, Nakuru, and Kisumu. Kenya National Archives, GP, 363.7.BRI. 1907.

from the lake, the third involving gravitating from Maranguisha river or some other stream on the Kinangop plateau.

Naivasha was seen as having no particular prospect in terms of serious development. It was proposed to be retained as a trading centre for sale of animals and may be horticulture because flowers seemed to flourish there. The headquarters of Naivasha province was to be moved to Nakuru, thus giving a greater chance of faster development³²⁵.

William estimated that the town would require about 3000 gallons for its use in the 15 years succeeding 1907 and that the population would not exceed 2000 persons (Table 3.18). He made his estimate based on a 70 litres per day per head rate of consumption and assuming 2,000 people³²⁶.

Until 1938 the only source of water to the government officials, the police and the jail was a well (the District commissioner's well) situated below the railway and near the post office. From the well water was carried up on cart to the various houses³²⁷.

Table 3.18: Daily water consumption for Naivasha Township by 1942

Department	Consumption (m ³ /day)
Administration (European and African)	0.863
Police (Asian, European and African)	1.37
Prison (African staff and inmates)	0.23
Meteorological (African)	0.14
Post office (Asian and African)	0.36
Medical (Staff and Patients)	1.36
Total	4.1

The history of this public water supply dates back to the colonial times in 1957. The first water pipeline in Naivasha served the public administration and farmers at the southern side of the lake. The source then was 100 mm diameter gravity main from the Aberdares (Kinangop) to the treatment works and thereafter into the distribution system serving just a few consumers³²⁸.

325 Williams G.B (1907). Report on the Sanitation of Nairobi and Report on the Townships of Naivasha, Nakuru, and Kisumu. Kenya National Archives, GP, 363.7.BRI. 1907.

326 Williams G.B (1907). Report on the Sanitation of Nairobi and Report on the Townships of Naivasha, Nakuru, and Kisumu. Kenya National Archives, GP, 363.7.BRI. 1907.

327 Roberts I. L (1960). Naivasha Water Supply. Kenya National Archives, ACW/31/79, Ref: DW. 213/4. 26th August 1960.

328 Roberts I. L (1960). Naivasha Water Supply. Kenya National Archives, ACW/31/79, Ref: DW. 213/4. 26th August 1960.

From 1963 to 1983 the then ministry of water development took over the water supply. The distribution system was rehabilitated and expanded, especially within the central business areas and some residential estates. Water from Kinangop finally ceased to reach Naivasha in 1985 due to the over tapping along the gravity main line. As a result this pipeline was disconnected in 1981 by the ministry and four boreholes were sunk in the western side of the town, which by the year 2001 were owned by the National Water Conservation and Pipeline Corporation. Three of the boreholes were equipped and pumping started in 1982. As a result of improper operation and maintenance of the facilities only one pump, with a capacity of 30 m³ per hour was left functioning.

The new water supply by 1983 included in the MUWS Programme was an Augmentation of the existing scheme. Table 3.19 gives the population and water demand projections for Naivasha Township.

The new intake involved: drilling of two boreholes, construction of new pump house, combined house and store and 10 m³ storage tank. In addition there was an installation of submersible pumps in the boreholes and installation of two high lift pumps and standby generator. The submersible pumps lifted water to the storage tanks and after chlorination water was pumped directly into the piping system in the town and towards the existing tank and gravity intake at the other side of Naivasha³²⁹. Figure 3.20 illustrates a sedimentation and sand filter with clear water on the background³³⁰.

Table 3.19: Population and water demand projections for Naivasha Township

Year	1985	1995
Population	20,700	40,000
Water demand (m ³ per day)	2,800	6,500

329 Hunn G (1983). Progress Report About water Projects included in the Minor Urban Water Supply Programme. NORAD –Coordinator/MOWD. Nairobi Ref: WD/1/2/5. 10th June 1983.

330 Hunn G (1983). Progress Report about Water Projects Included in the Minor Urban Water Supply Programme. NORAD, Nairobi.



Figure 3.20: Sedimentation and sand filter, clear water on the background

Other works included laying of new pumping line from borehole site to the existing 600 m³ storage tank and augmentation of the same tank with a 6990 metres of pumping line, construction of a new 500 m³ storage tank at the existing treatment works (figures 3.21 and 3.22) and construction of new sludge lagoon at treatment site. Hem Singh Bhaagra was awarded the civil and electromechanical contract for the sum of KES 5.9 million. The contractor completed the civil works which were commissioned in July 1981.

On the 1st July 1983 the Municipal Council of Naivasha took over the distribution system from the Ministry of water development with 985 consumer connections. Due to the increasing demand of water in the town, the council sunk two more boreholes in 1990. The Naivasha municipal council started buying water in bulk from the corporation and then distributed it to the consumers. By the year 2001 the scheme had 2522 consumer connections. There were also numerous privately owned boreholes, which subsidized the shortage through water vending to the public. The area supply was 77km² and no treatment was carried out. The scheme had a total storage capacity of 911 m³ with a distribution network of 23 m³³³¹ .

331 The World Bank WSP – EASA (2001). The Development of the National Policy on Environmental Sanitation and Hygiene: A Situation Analysis on the Legal, Institutional and Resource Mobilization Frameworks Affecting the Environmental Sanitation and Hygiene (ESH) Sub-Sector in Kenya. Draft report.



Figure 3.21: Naivasha full treatment at the existing scheme by 1983³³²



Figure 3.22 Addition of Soda-Ash and Aluminium Sulphate through fro-dozers, 1983³³³

Kericho Water Supply: Before 1914, springs and streams were the main source of water in Kericho. An Indian, V. Anandji, constructed the First water dam and its mill in 1914 on Riondoseik River. Other Indians followed suit and constructed six

332 Hunn G (1983). Progress Report about Water Projects Included in the Minor Urban Water Supply Programme. NORAD, Nairobi.

333 Hunn G (1983). Progress Report about Water Projects Included in the Minor Urban Water Supply Programme. NORAD, Nairobi.

more dams between the years 1916 and 1920. The Public Works Department in its effort to augment the supply built its dam along the Kimugu River in 1930. The dams and their mills were built along the two rivers (Riondoseik and Kimugu) on either side of the township.

Meanwhile, by the year 1920 all the government houses in the township had been fitted with water tanks. The water was used mostly for drinking purposes. During the dry seasons the convicts and porters fetched the government officials' water from adjoining streams. There were two streams on either side of the station, thus the supply was sufficient³³⁴.

By 1924 the Kericho District had only two townships, Kericho and Sotik. Sotik had an officer stationed there and its general appearance and cleanliness had improved. The main water supplies for the district up to 1929 were, rivers, springs and rainwater. There was a very heavy rainfall in 1926, which brought about drainage problems. The Africa Inland mission drained the swamps near the mission and supervised planting of rice and other economic crops. In 1928, investigations into Kericho township water supply scheme showed that the scheme, if implemented, would pay back 10% of the total cost. In 1929 the Kericho township water supply scheme began in earnest.

The township water supply scheme commenced with installation of one Blakesram. A small weir was built on the Kimugu River and the delivery pipes were put as far as the hotel. However, the total cost was underestimated and the progress stalled. In January 1930, the district surgeon observed that the commencement of water system in government and other buildings showed that the township was in a transition stage. The township therefore needed regular supervision by sanitary inspector and staff. The surgeon proposed a careful consideration of a water carriage sewage disposals system for proposed hospital and business area. The site and nature of soil was suitable and there was ample water supply, hence the provision at the time of construction was economical³³⁵.

In July 1930, the district surveyor allocated a new layout and survey of the township and waterworks reserve plot. The new water supply, delivered by a large Blake's ram on the Kimugu River, started to function during the year. However, owing to shortage of materials, connections to all houses, residences etc. had not been completed by the end of the year. It was expected to end in 1931³³⁶.

334 District Commissioner, Kericho (1920-1923). Kericho District Annual Report, 1920-1923). Kenya National Archives, DC/KER/1/1, Ref: 1839 No. 1.

335 District Commissioner, Kericho (1924-1929). Kericho District Annual Report, 1924-1929). Kenya National Archives, DC/KER/1/2, Ref: 1829 No. 1.

336 District Commissioner, Kericho (1920-1923). South Lumbwa District Annual Report, 1930. Kenya National Archives, DC/KER/1/3, Ref: 189 No. 1.

Kericho Township was growing rapidly and by 1931, more residences and shops had been built. The demand for water was increasing, sixteen residences and shops had been connected with water supply and ten more applications were being processed. The District Commissioner recommended that storage tanks be provided. The ram provided 32 m³ per day that was barely sufficient in view of the hospital and other requirements.

Water dams and mills in Kericho: Between 1914 and 1930, seven water mills and their dams belonging to private owners had been constructed. One water mill and its dam belonging to the government had been built on the Riondoseik and Kimugu rivers within the township. However, in November 1930 the need to demolish the privately owned dams was expressed by the Township committee and the Medical officer. This was because:

- They were of little or no value to the community service since three more, much larger mills driven by oil engines had been established.
- The dams were breeding places of the anopheles mosquitoes. At this time the town had the highest cases of malaria in the province.
- Kericho Township was developing rapidly and the dams had ceased were not being used. The mills had ceased to be of economic value.
- The filthy state of the mill houses.
- To pave way for further developments.

Equally, demolition was important to those constructing the bazaar as it obviated the need for carting water from the rivers. The installation of a storage tank at the end of the year was a boon as it could provide a constant supply and allowed sediments to settle down³³⁷. In 1941, the director of Medical services considered the provision of purified water supply for the township both necessary and urgent. It was important that the construction of Kericho township water supply scheme continued regardless of war for the benefit of the public.

Consumers made complaints severally over the untreated and turbid water supplied. The pumping units consisted of an 'A' type hydraulic ram and a pump driven by oil engine.

Future works for the township included; the provision of oil driven pumping units, purification works, coagulation, filtration and sterilisation. The water was pumped into a small elevated storage reservoir to serve the houses at a higher level. This held a capacity of 11,000 gallons (50 m³.)

³³⁷ Health Officer (1932). Annual Report, 1932: Native civil Hospital-Kericho. Kenya National Archives, PC/NZA/2/14/16.

The Health Inspector, Kisumu Medical Department, expressed the urgency and importance of a comprehensive and adequate water supply to the Kericho Township. This was important so as to enable the construction of a proper drainage and sewerage system³³⁸.

There were more than eight dams owned by Indians in the township. All the Indian owned dams were found breeding *Anopheles* mosquitoes by the medical officer. Only the Public Works Department's dam was not favourable for such breeding. This was connected to the rise of the malaria cases from 293 in 1935, to more than 570 in 1942.

To arrest the situation all the dams breeding mosquitoes had to be demolished. To ensure this was done, the senior medical officer of Nyanza province, Dr Garnham, recommended the enforcement of the Public Health Ordinance. However, it was difficult since the dams were not part of the premises occupied by the persons committing the offence. They were declared illegal structures and the simplest way was for the Local Authority to demolish them. An additional sum of 970 pounds to the 1943 expenditure of 600 pounds was made. This was meant specifically for installation of a coagulation basin on the existing reservoir together with requisite distribution mains serving high-level residences. The scheme was to proceed regardless of the war. The Provincial Commissioner, Nyanza expressed the need to retain the existing Public Works Department dam but demolish all privately owned³³⁹.

By November 1943, the Public Works Department had accomplished the following as part of Kericho Water Supply Scheme augmentation³⁴⁰.

- The survey of the new intake site was in progress.
- The pumping machinery for new installation had been purchased, one engine was available and more consignments of engines were expected.
- Materials for construction of purification works were being assembled.
- Labour and technical arrangements were being made.
- The chemical dosing apparatus had been fabricated.

This water supply was established in 1929 but only raw water was being supplied. A treatment works for this supply was constructed around 1943.

338 Health Inspector, Kericho (1929-1960). Kericho Township Water Supply. Kenya National Archives, BY/21/59, Ref:6330 No 256.

339 Colony and protectorate of Kenya (1931-1945). Kericho water supply, ref. PC/NZA/2/16/10, Kenya National Archives, Nairobi Kenya.

340 Colony and protectorate of Kenya (1931-1945). Kericho water supply, ref. PC/NZA/2/16/10, Kenya National Archives, Nairobi Kenya.

By 1952, of the five townships in Kericho district, Kericho Township was the only one with a water supply. At Chemagel, water was carted from a river a one and half kilometre distant. It was stored in drums at the rear of the premises³⁴¹.

Turbo Water Supply: Turbo Village is classified as a rural centre and is located in Uasin Gishu District, Rift Valley Province. The centre is situated 30km west of Eldoret on the Eldoret Tororo (Uganda) Road. Prior to MUWS project, there were four different water supplies at Turbo, all using Sosiani River as source. The country council's water supply supplied filtered water, while the other three supplied untreated water. The capacity of the schemes was completely insufficient, and Sosiani River was muddy and polluted.

Turbo water supply was designed by Nor Consult and constructed by K. Ramji. The project was commissioned in September 1982 at a cost of approximately KES 9 million. The population growth and water demand figures were projected as shown in Table 3.20.

Table 3.20: Population and water demand projections in Turbo by 1975

Year	1975	1985	1995
Population	7000	8730	11,100
Water demand (m ³ per day)	570	820	1250

The operational problems experienced included no storage for the various chemicals; and two generators installed with identical outputs were sufficient to cover the power demand of their respective stations but not the standby capacity.

Recommendations: The Scheme be supplied with electricity from East Africa Power and Lighting Company and waters kiosks be built in the town centre for the poorer population at a cost of KES 1.7 million.

Kedong Valley water Supply and Permits: The area surrounding Kedong valley was inhabited by settlers living side by side with the local people, the Maasai were herders while the settlers practiced agriculture. To both communities, water was a precious commodity for irrigation to the settlers and watering the stock for the Maasai. Water development works in Kedong valley started before 1910. In this issue, major developments that took place between 1910 and 1934 are reviewed.

³⁴¹ Health Inspector (1952). Memorandum on the Work of the Health Department, Kericho District. Kenya National Archives, BY/29/34. 8th September 1952.

The relationship between the settlers and the community, water sharing between the two and the government contribution are the primary areas discussed.

In 1912, to facilitate the flow of water and increase the supply for the benefit of the residents in the lower part of the Kedong valley, the director of public works ordered Mr. Bowker of Norfolk Hotels to clear channels through the swamps on the tributaries of the upper Kedong to facilitate the flow of water. However, expertise was needed for concrete and worthwhile work to be done. The volume of water in the swamps was temporary and varied with seasons³⁴².

According to Mr. Bowker, during the rainy seasons the swamps conserved water that drained back into the riverbed as the level fell during the dry weather thereby prolonging the dry weather flow. Bowker reasoned that if channels were not cut, conservation would take place in the rains and water would rush away to wastage henceforth detrimentally affect the all those concerned. He instead supposed that the true solution was not the destruction of the conservation rather the increase there of by damming the river at suitable sites. With this, the director further suggested the clearing the channels through the swamps³⁴³.

The governor, H.C. Belfield authorized the PWD officers and their agents to construct canals and other forms of public works in various lands necessary for improving the flow of Kedong River.

The Kedong River used to be the boundary between the British East Africa and Uganda. Water trouble in the Kedong valley started in 1908, with the first complaint that reached the Director of Public Works in October 1908 complaining that water did not reach Mr. Buxton's farm. Complaints continued and in October 1908 a complete investigation of the water resources of the valley were made. This showed a yield of water from the escarpment of 1,200,000 gallons, the whole of which disappeared before reaching Mr Barkers farm. Below the fourth tributary, the flow dwindled from 1,200,000 gallons to 350,000 gallons, and by the time it reached the junction of the two streams it dwindled to 76,000 gallons and by Mr Barker's farm, it ceased to run.

Half a 2273 m³ from the 5,455 m³ entered a swamp of five acres and became completely lost there. The state of affairs became increasingly serious and the condition of the farms could be described as "famine". People got drinking water thirteen

342 Bowker W.R, (1912). Your Excellency. Kenya National Archives, Kedong Water Supply, 1912-1913. 18th November 1912.

343 Bowker W.R, (1912). Your Excellency. Kenya National Archives, Kedong Water Supply, 1912-1913. 18th November 1912.

kilometres and six kilometres away at various places. This prompted a meeting in 1909 to discuss the situation³⁴⁴.

Distribution of water to settlers: In accordance to the meeting held in 1910, the land board was called upon to the question of distribution of water to settlers in Kedong valley. The land board recommended government to take action to effect a redistribution of water in the Kedong valley where the existing supply could be made to serve as many residents settlers as possible³⁴⁵.

On his letter to the secretary of East African Protectorate, H.B. Dooner of Elpis Ostrich Co. complained that even after heavy rains and the rivers resumed normal flow, the swamps took all the water leaving the areas with no water even for drinking purposes. The Uganda Railway originally drained the swamps when the line passed through the valley. However, the furrows were not kept in repair and they silted up and became useless.

1934 Onwards/ Maasai settlers conflict: In April 1933 McConnell (water engineer PWD), Mr. Deck, Brailward (DC Kajiado), DC Narok, and Anderson, met at Knightwick estate to discuss water in Kedong River. After visiting the Knightwick dam, full flow of the little Kedong was examined. Mr. McConnell was absolutely satisfied that nothing could be done on the big Kedong to influence the water of the little Kedong. This was very controversial since the Maasai complained that irrigation at big Kedong adversely affected the flow of the little Kedong. The Maasai had lived and grazed at Kedong valley before the white settlement. Mr. Deck, representing the Maasai said that he favoured seasonal grazing and a pipeline from Waykei towards mount Suswa as a solution and piping the little Kedong as an expensive alternative. Mr. Anderson was against provision of water to Maasai all year round citing that it would ruin the country. He argued that watering shortage in the lower Kedong valley had been a boon to the Maasai as it preserved that part of the Reserve to be of some economic value³⁴⁶.

The light lava soils, he claimed could not stand the heavy tramping of the Maasai herd in the dry weather, and dry weather was not a matter of an occasionally bad year but a real regular season occurrence that had to be legislated for. Such conflicts reoccurred in every dry season and similar endless arguments reoccurred

344 Minutes (1912) Minutes of the meeting of a Land Board on Kedong Valley Water Supply, attended by: Land Officer, Mr. Drooner, Mr. Stevens, Mr. Grant, Major Nox, Mr. Cloete, Mr. Guy, Mr. MacDonald, Mr. Watkins and the director of public works. 9th January 1912.

345 Acting Chief Secretary (1911). Kedong Water Supply 1912-1913. Kenya National Archives Ref: 125/126 18th December 1911.

346 Anderson C.G (1934). Mt. Margaret Escarpment. Kenya National Archives, DC NGO/1/14/11, 9th June 1934.

with every new official. Mr. Anderson reasoned that this denied the settlers a chance to improve their farms and endeavouring to maintain fodder reserves, which were to the benefit of the colony in providing food in dry season³⁴⁷.

The lower Kedong had economic value in wet season, the grazing was fair, and Anderson advocated for grazing in this place in the wet season and then other places thereafter. Otherwise, he termed grazing every place all the year round as careless and criminal destruction of the land.

Anderson maintained that the Maasai had become equal to every other user of the land, and they were better positioned as they could access other communal lands unlike the settlers. As Anderson observed “being backward native races did not entitle them or their advisors to destroy the land they held”³⁴⁸.

Application for water permit: Mr. R. Stephen farmed on a land on the Big Kedong River, Naivasha district. He made an application to divert 50% of the flow of the stream (of which he proposed to return 89% of the abstracted) at the point of diversion from Kedong River in the Naivasha district for the purpose of watering stock, irrigating vegetable shamba and domestic use. Before then, in January the Provincial commissioner and the PWD offices complained objected to Mr. Stephen application arguing that he was diverting the river flow for irrigation, which caused shortage in the reserve. The PC, Maasai and the hygrosopic surveyor found out that he actually diverted 90% of the river and practically none returned to the river³⁴⁹.

More claims about the diversion from the provincial commissioner, Maasai, prompted the Assistant Engineers visit. He found that Mr. Stephen diverted the whole flow of the river into the furrow for irrigation. Stephen did this whenever he considered fit irrespective of the rights of the downstream riparian rights holders were entitled. Mr. Stephen had always vigorously objected to all abstractions from the big Kedong and its tributaries no matter how small the amount was. The assistant engineer ascertains that had Mr. Stephen not diverted all that water the river would have flowed further five kilometres into the Maasai Reserve. He recommended that Mr. Stephen’s dam be summarily destroyed³⁵⁰.

Lodwar and Lokitaung Water Supply: The gorge extending from the shops across the water hole and bathing pools was continuously fouled with human feces and

347 Anderson C.G (1934). Mt. Margaret Escarpment. Kenya National Archives, DC NGO/1/14/11, 9th June 1934.

348 Anderson C.G (1934). Mt. Margaret Escarpment. Kenya National Archives, DC NGO/1/14/11, 9th June 1934.

349 Native Lands Trust (central) Board, (1932). Precis for Central Lands Trust Board, Application for Water Permit. Kenya National Archives DC NGO/1/14/11. 25th June 1932.

350 Native Lands Trust (central) Board, (1932). Precis for Central Lands Trust Board, Application for Water Permit. Kenya National Archives DC NGO/1/14/11. 25th June 1932.

the sweepers were always cleaning it. Water supply to the boma was from a hole where all the natives brought their own dirty buckets and ropes to draw water. The district clerk issued a tin with a rope to draw water to fill their respective utensils³⁵¹.

In 1953, a significant fall in the river flow in Lokitaung was recorded. In March the flow measured 21.8 litres per minute but flowed at 4.5 litres per minute in September. The probability of drying up altogether was projected, which prompted a change of plan. The original plan for a concrete dam and diurnal reservoir was unjustifiable. Instead, the following were recommended³⁵²:

Lokitaung proposal, because of little knowledge on underground watercourses in the riverbed. Immediate installations of a hand pump with pipes to take the one of the two 1,000 gallon tanks. Treatment of water with chlorine made possible by the availability of two tanks and funds from the administration. An additional of 20,000 pounds for the purchase of earth moving machine and other mechanical equipment was required.

By 1955, water was still drawn from shallow wells and distributed by animal transport. The wells were liable to contamination, it was hard and heavily saline. Piped water supply was under consideration so as to improve the amenities of life for all the population in Lokitaung. In 1958, the supply in Lokitaung was both unreliable and insufficient for normal hygienic purposes. This was expected to worsen due to development of the market centre. The ground was not suitable for pit latrines. This called for more water needs in future³⁵³.

Lodwar water supply scheme was expected to be completed by 1948. The work was expected to combine with the scheme to lay porous pipes across the riverbed along the Suam River³⁵⁴.

In 1954, the District Commissioner prepared a simple plan for water provision in Turkana district. The objective was to provide large numbers of small capacity water points. This was proposed in areas where nature favoured inexpensive construction and where water was required. He deliberately avoided boreholes and large schemes. The plan involved development of; rock catchments, earth pans, earth dams, masonry dams, sub surface dams, permanent wells and tube wells³⁵⁵.

351 Sub-Assistant Surgeon, Lokitaung (1942). Monthly Report for November 1942. Kenya National Archives, BY/9/81. 7th December 1942.

352 Koch B.R.C (1953). Lokitaung Water Supply, Kenya National Archives, DC/LDW.2/24/5, Ref: DW375/8, 23rd September 1953.

353 Whitehouse L.E (1958). Lodwar Water Supply, Kenya National Archives, DC/LDW.2/24/10, Ref: 8/3/1/70, 13th May 1958.

354 Koch B.R.C (1953). Lokitaung Water Supply, Kenya National Archives, DC/LDW.2/24/5, Ref: DW375/8, 23rd September 1953.

355 District Commissioner, Turkana (1954). Turkana District Water Development Scheme, Kenya National Archives, DC/LDW.2/24/5, RefPW.8/4/2/A/12, 4th May 1954.

Water Rationing: An acute water shortage was recorded in Lodwar, which instigated rationing. Water rationing was expected to start in November at various areas on different hours. The District Commissioner issued notices of the anticipated rationing at various stations. In some stations, rationing started at 9.00pm and lasted until 6.00am while in others from 10.00 am to 4.00 pm³⁵⁶.

Piped water Supply: By 1958 October, porous concrete pipes had been laid approximately half way across river Turkwel. The District Commissioner coordinated the work. Senior Inspector of Water Supplies was supposed to give the River Turkwel work priority and for prompt completion using Operation and Maintenance funds. By January 1960, the work was almost complete. The divisional engineer commended the District commissioner's initiative and drives to have accomplished that work. It was known that a lot of water existed under the riverbed at the driest part of the dry years. However the existing porous piped system lay above the lowest level of water table. To relay the pipes at a lower level would have been very difficult, costly and risky in view of flash floods during construction. Water supplied in 1960 contained fine sand which made metering impossible. With consumers on flat rate, consumption was naturally very high about 77.3 m³ per day. The 1960 existing Lodwar supply had almost ran dry by September³⁵⁷.

The cost of running Lodwar water supply for one year by 1957 was 898pounds. The cost involved; operation and maintenance, annual contribution to renewal fund and overheads. The supply was not profitable at 5 shillings per 4.5 m³. The engineer recommended for an increase in the water rates to enable the supply pay back³⁵⁸. In 1958, flat rate charges for the hospital, school and police lines were changed and made similar to those of the prison, as per the recommendations of the hydraulic engineer. A flat rate of 10 shillings a month per shop was levied³⁵⁹.

In October 1958, the Divisional Engineer inspected water supply in Lodwar. It was found that the Kiosk was open all day long and no charge was made for water supplied from it. The District Commissioner stopped this and made the kiosk be opened for two periods of one hour each day and to charge for water supplied at 2 cents per 18 litres. The District Commissioner agreed also to supply locked cashbox issued daily by his cashier. The main intention was to increase the revenue and reduce the demand from nomadic, non-employed Turkana who used the Kiosk

356 District Commissioner, Turkana (1957). Water Supply, Kenya National Archives, DC/LDW.2/24/10, Ref: 8/3/2, 1957.

357 Gardener D.G.M (1960). Lodwar Water Supply, Kenya National Archives, DC/LDW.2/24/10, Ref: WVN.5/4, 8TH September 1960.

358 Chief Hydraulic Engineer (1957). Lodwar Water Supply-Increased Rates, Kenya National Archives, DC/LDW.2/24/10, Ref: 19th June 1957.

359 Divisional Engineer (1958). Lodwar Water Supply, Kenya National Archives, DC/LDW.2/24/10, 22nd October 1958.

almost entirely. They could fetch water from the sand holes in the river just as they used to do before installation of the kiosk³⁶⁰.

In 1959, the DC opposed the allowance of 10 gallons per head per day at the rate of 5 shillings per 1,000 gallons for the Turkana. He opposed the allowance of 18 litres per head per day at the rate of 5 shillings per 1000 gallons for the Turkana. He complained of high rates for the administration and departments. Turkana local people were few in number and were small consumers who took their water in small metal containers. The DC argued that 18 litres per day was excessive and that Turkana only required 9 litres per head per day and further observed that the majority of the Turkana in the government lines were women and children whose requirements were very small³⁶¹.

In July 1959, the government agreed to the payment for water on flat rate based on the Gazetted rate of 5 shillings per 1000 gallons. This was attributed to the sand, which was constantly in the supply system at Lodwar making it difficult to metre the consumers.

This was applicable only in, the prison, hospital, school, police lines and the administration³⁶².

The Lodwar Water supply ceased to be a Gazetted supply as at 12th January 1960 and the secretary for the work ceased to be responsible for collection of revenue. From then, government servants were expected to pay for water from their salary in accordance with Establishment circular No. 36 of 10th September 1958³⁶³.

It was a government policy in regard to water charges to levy a charge if it cost the government to supply water, unless the supply was inadequate or polluted. Investigations into supplies was done in 1960 and it was found that, majority of the officers who worked in the field and were supplied by tankers or in drums were not charged due to inadequate or poor quality supply. On the other hand, if the supply conformed to the policy, the charges were adjusted on salary basis irrespective of marital status or the size of the family. Water charges fixed on this basis were notified to the service by an establishment circular³⁶⁴.

The DC expected a total of 410 shillings a month from water charges from the tribal police, station hands and camel syces, six shopkeepers and the Somali depor-

360 Divisional Engineer (1958). Lodwar Water Supply, Kenya National Archives, DC/LDW.2/24/10, 22nd October 1958.

361 Permanent Secretary for Works (1959). Lodwar Water Supply, Kenya National Archives, DC/LDW.2/24/10, Ref: CA. 313/338, 30th July 1959.

362 Permanent Secretary for Works (1959). Lodwar Water Supply, Kenya National Archives, DC/LDW.2/24/10, Ref: CA. 313/338, 30th July 1959.

363 Chief Hydraulic Engineer (1961) Lodwar Water Supply, Kenya National Archives, DC/LDW.2/24/10, Ref: WVN.5/17, 27th March 1961.

364 Hill G.G (1960). Lodwar Water Supply, Kenya National Archives, DC/LDW.2/24/10, Ref: MOW.8/3/1/267, 21st November 1960.

tees. The only considerable body of Turkana who drew water from that point was the “Maskini” and they were expected to be moved from the area to Lake Rodulf. A charge of 20 shillings a month was anticipated once the piped supply was fully installed³⁶⁵.

Lodwar Prison Water Supply: By 1952, there were 519 prisoners, all men. It was administered by 2 Europeans and 92 African policemen. Lodwar prison was overcrowded at the floor area of 13.4 ft² per prisoner. It was recommended that some of the prisoners be transferred to other prisons or more accommodation be built to allow a floor area of 20ft²per prisoner. Water supply was piped from main supply at a quantity of 7.8 m³ daily and was not treated. It was impossible to supply as much water as the camp normally required.

Each prisoner received about 16 litres daily for drinking and washing. Bathing in the river was allowed once a week. Water for cooking was provided centrally to the kitchens³⁶⁶.

Lokitaung Prison by 1952: There were only six prisoners, all men, in this prison. It was administered by one European district officer and nine Africans. Water supply at Lokitaung was obtained from a well and was very adequate for six prisoners. It was stored in a 200 litre drum and chlorinated³⁶⁷.

Kajiado Water Supply: As at 1957 Kajiado was the administrative centre of the Maasai district, at the time there were neither industries nor any likely development. The water consumption was between 59m³ and 95m³ per day. Increase in water consumption was expected to result from mission school, E.A railways and harbours and ranching schemes. With such expected areas of consumption likely to arise the water demand was thus estimated to rise to 114 m³ per day and later to 159 m³ per day in 1970.

The township of Kajiado as at 1957 was being served by two boreholes constructed by the Ministry of works. The boreholes were being operated 24 hours per day with a combined output of 54.6 per day. The balance of the daily demand was made up by purchasing bulk supplies from the Ngong pipeline.

365 District Commissioner, Turkana (1958). Lodwar Water Supply, Kenya National Archives, DC/LDW.2/24/10, Ref: 8/3/1/106, 7th November 1958.

366 Stott H (1954). Lodwar and Lokitaung Prison Camps. Kenya National Archives, BY/6/16. 23rd July 1954.

367 Stott H (1954). Lodwar and Lokitaung Prison Camps. Kenya National Archives, BY/6/16. 23rd July 1954.

A third borehole had been drilled in 1956 so that the estimated total yield from the three boreholes was 91m³ per day with 24 hours pumping. The third borehole became blocked internally. This borehole was never cleared nor equipped as its use would not have not have permitted supply to run independently of the Ngong pipeline. No supply can run on a 24 hour pumping daily, the normal design maximum being 8–12 hours thus augmentation of Kajiado water supply was deemed extremely necessary.

There were four possible methods of augmentation worthy of consideration:

- Further boreholes in Kajiado
- Boreholes at alternative site
- Surface water
- Augmentation of Ngong Pipeline

Option (a) was discounted due to the requirement of duplication of the mechanical equipment to ensure safety of supply. Thus if more boreholes were drilled then each borehole would have required two pumps each. The quantity of the water in the aquifer was believed not to be large and it was known that when one borehole is pumped, the abstraction from the others was affected. This option was thus seen as being expensive, difficult to operate and of uncertain potential.

With respect to option (b), good borehole existed in an area 24 kilometres from Kajiado but again the high pumping costs made the option uneconomic and hence unacceptable.

The question of surface water was again deemed expensive as it was believed that such an option would mean that the town had to depend on flood flow and thus a storage dam, treatment plant, and supply mains would have to be constructed. There were no permanent surface water sources in the area at the time. The Ngong pipeline constructed by the Magadi water company provided the only practical solution although it required rehabilitation which was deemed expensive but economic in the long term.

Ngong Water Supply: In 1946 there existed a piped water supply in Ngong. This water supply appears not have been officially sanctioned by the government. The director of public works in his letter to the officer in charge, Maasai, Ngong explained that the supply that existed at 1946 had grown from time to time without official sanction and did not bear relation to the potential requirement of the township.

The water supplied was piped to the officers in charge's compound and the over flow was then allowed to be used by the rest of the residents³⁶⁸.

Ngong Township had grown and its water requirement had increased and was expected to grow further. It required agent arrangement for water supply but the shortage of staff meant that not all the proposed water supplies could be developed. The water supplies were allocated priority for development depending on the agency of need for the water supply.

In April 1946, an Assistant engineer Mr. Mullen undertook a survey of the water sources in the vicinity of Ngong Township and conclude that there was no source large enough to base a township water supply. He thus proposed a geophysical survey to determine whether underground sources would provide an adequate source of water.

In 1948, the then Governor who was planning to retire, had proposed to reside in Ngong. This meant that all the water from the Hills would have to be reserved for him. Meanwhile a borehole was under construction for the augmentation of the township water supply.

In December 1948, the water supply for Ngong was nearing completion, but the issue of how the residents were to be connected to the water supply remained outstanding. The Director of Public works Mr. Tetley in his letter to the Officer in Charge, Maasai, Ngong, explained the procedure for establishing a connection:

The water supply provides the water to the township in service mains; these are the responsibility of the water supply. The water is taken off for premises through connections, which are installed at the cost of the particular consumer concerned; these are usually laid by the water supply, on repayment from the consumer. Each consumer connection has a metre and stop cock, the former is supplied by the water supply, which charges a small sum monthly for the hire of the metre.

Immediately after the completion of the borehole, to supply water to Ngong Township another problem set in; the Maasai who had provided land on which the borehole at Ololua had been built wished to be provided with a trough and free water for watering of their livestock. In a Baraza held by the Local Native Council of Ololua, the natives proposed that the:

Public works department ought to provide compensation in the form of free water, or alternatively that they ought to pay an annual rent for the land they had taken for the borehole and that water should be paid for from that sum.

By 1983, Ngong was the divisional headquarters for Ngong Division, Kajiado district, Rift Valley Province. Ngong urban centre is situated 20km West South

368 Colony and Protectorate of Kenya, (1946). Maasai District, Ngong Water Supply. Kenya National Archives, Ref: DC/Ngong/1/14/1, Nairobi, Kenya.

West of Nairobi which was developing into a suburb for the capital. The existing water supply consisted of three boreholes, two booster pumps each with 22 m³ pump sumps, three reservoirs with a total volume of 360 m³. The total production was 400 m³ per day.

The proposed scheme: The consultant for the scheme, Sir Alexander Gibbs and Partners estimated the population growth and consequent demand in the design for Ngong water supply as shown in Table 3.21.

Table 3.21: Projected population growth and water demand for Ngong water supply

Year	1985	1995	2005
Population	33,100	52,200	-
Water demand (m ³ per day)	1,830	4,200	10,000

Ngong water supply was somewhat complicated since there was a serious future problem of obtaining sufficient water for large population. The problem was not finally solved. An additional problem was that Kajiado water supply extracted water from boreholes and springs within Ngong supply area. Implementation of Ngong water supply commenced just before 1983 and five boreholes were drilled, it was estimated to cost KES 46 million. The total capacity of the water available was 1860m³, a capacity that was expected to cover the demand by ground water up to 1985/86.

It was clear that covering the future with ground water was very complicated and an additional 14 boreholes were required within the year 2005. However, it was uncertain whether the ground aquifer was able to produce the required amounts of water. Supply of piped water from Nairobi was most likely. A new Kajiado water supply was anticipated to become operational in 1988 providing 500 m³ per day and that 500 m³ per day of the existing water source could be utilized for Ngong water supply.

Magadi Soda Company's Ngong Pipeline: By the agreement with government dated 1929 the Magadi Soda company was permitted water rights for a period of 99 years dependent on conditions including a supply to the East African railways and harbours and the Maasai. By the agreements dated 1933 and 1942 sales of water to Kajiado Township were authorized³⁶⁹.

In 1957, Ngong pipeline had the following major points:

369 Colony and Protectorate of Kenya (1958). Water Supplies Magadi. Kenya National Archives, Ref: PC/NGO/1/6/16, Nairobi, Kenya.

- The East African Railways and Harbours no longer require water as diesel locomotives had replaced the steam engines;
- The supply to Magadi as at 1957 was being made by a new pipeline from another source;
- The Obligations to provide 81 m³/day free to the Maasai, was being met by boreholes at Turoka; and
- The Magadi Soda Company was thus running the pipeline for the purpose of bulk sales to Kajiado Township.

In the light of the above points as regards the position of the Ngong pipeline some discussion was held in 1957 and attended by Magadi Soda Company, E.A. Railways and Harbours, the provincial administration and the Hydraulic Branch. The following future train of events was discussed³⁷⁰.

The Magadi soda company wished to be relieved of the responsibility to supply water to Kajiado; and

The company was prepared to hand over their pipelines and associated assets (from Kajiado and upstream) to the government free of charge provided: the 1929 agreement is cancelled and the company was allowed to retain their house and approximately 10 acres of the 99 acre headworks plot at Ngong.

The tentative date for Magadi Soda Company to relinquish the ownership of Ngong pipeline was set as 1.7.1958 when it was expected the 1933 and 1942 agreement would terminate.

However it acceded that in the event that an agreement was not reached then: the company would continue to freely supply water to the Maasai at their Turoka boreholes and the agreement with the ministry of works to rates and conditions to continue to supply water to Kajiado.

If an agreement was to be reached and the government took over the Ngong pipeline then Magadi Soda Company would continue to provide water to the Maasai at their Turoka Boreholes (probably at a cost for 5 to 10 years).

During the discussion, various alternatives were discussed suggested: that in acknowledgement to companies retention of the house and 10 acres, the company might supply 45.5 m³ per day free water at Turoka to the Maasai and that the rents the pipeline to the government for a nominal sum (but retain their water right) and the government then operates and maintains it.

Right from the inception of the Ngong pipeline the Maasai were at the heart of it. The springs were the source of water for their livestock and hence taking it meant

370 Colony and Protectorate of Kenya, (1958). Water Supplies Magadi. Kenya National Archives, Ref: PC/NGO/1/6/16, Nairobi, Kenya.

that they had to be provided with alternative source or supplied from the same. Thus with a looming takeover of the pipeline by the government, the question of water supply to the Maasai became central to the operation of the pipeline. Several suggestions were forwarded: That, 81m³ be allowed back to the Kiserian River for the Maasai or 36.4m³ be made available at Cairn Hill tank for the Maasai.

Although both suggestion were technically challenging and required the provision of a storage tank to equalize flows during dry weather, it was still agreed that the Maasai needed at least 36.4m³ per day for their stock³⁷¹.

After government take over the government was to renew the pipeline within a few years. During this period the hydrological data was to be obtained. In case the dry weather flows fell below the demand, the two existing boreholes would be used to supplement the supply. When data was at hand then a final scheme would be designed to take care of storage reservoirs and/or the retention of the boreholes in a stand-by capacity.

The ultimate design capacity was to take care of estimated 1970 demand of about 159 m³ per day. The 36.4 m³/day for Maasai at Cairn Hill tank and about 32m³ per day for further ranching schemes that may develop was proposed.

Operational problems related to submersible pump, flocculation motor and chemical pumps were observed after 18 months of operation. Obtaining sufficient chemical for the treatment was one of the major difficulties encountered. Other challenges encountered were:

The presence of 400 connections but there were no communal water points or Kiosks in the area; the water was not metered, but the tariff for the individual connections was KES 40 per month and the old distribution system was poorly maintained, but no figures regarding loss of water were available. Figure 3.23 illustrates a Lagoon constructed for cleaning water cleaning water after backwash.

371 Colony and Protectorate of Kenya (1958). Water Supplies Magadi. Kenya National Archives, Ref: PC/NGO/1/6/16, Nairobi, Kenya.



Figure 3.23: A Lagoon for cleaning water after backwash in 1983³⁷².

Since there was only one borehole, there was no standby capacity available in case of breakdown of the submersible pump. An additional borehole was therefore required. The scheme was producing below the demand.

Elburgon Township Water Supply: In 1950, the only source of water to Elburgon Township was a small grossly polluted stream. The Nakuru District Commissioner made representations for the provision of a water supply for Elburgon Township. He indicated a demand of 45.5 m³ per day and supported it with the population figures.

The railways had put down boreholes, which only sufficiently served the administration. The acting director of public works directed a priority for the township before carrying out survey on the area. He was very concerned that the priorities committee should consider the township in Water Resources Authority meeting³⁷³.

Elementaita Water Supply: Initially Elementaita was a stock route and the inhabitants got water from the railways supply. However, the alteration of the railway alignment left the inhabitants without water. The obligation to supply water to

372 Hunn G (1983). Progress Report About water Projects included in the Minor Urban Water Supply Programme. NORAD –Coordinator/MOWD. Nairobi Ref: WD/1/2/5. 10th June 1983.

373 Acting Director of Public Works (1950). Elburgon Water Supply. Kenya National Archives, PC/ NKU/2/25/31, Ref: PW.D.2323/117/2/1/66. 5th June 1950.

Elementaita was left under the government authority. To salvage the situation, the East Africa Railways and Harbour paid to the Kenya government some 71,000 pounds in full settlement of all its obligations. With that amount, the government was to provide roads to about 72 kilometres, fencing for stock routes and the necessary water supplies³⁷⁴.

In 1955, the villages got small amount from Lord Delamere's farm water supply for which they paid. The contract between the public works department was precarious and contained clauses like 'the Lord Delamere would supply if he can certain quantities'. The quantity supplied was low and prevented a reasonable standard of cleanliness or advance in that settlement. It was in 1955 that the Nakuru county council came in with intentions to develop a water supply for Elementaita. They studied the history about Elementaita and found out about the 71,000 pounds given to the government. The council clerk, Mr. Perreau was suspicious that nothing was spent on this water supply³⁷⁵.

The council was anxious about the inadequate water supply at Elementaita trading centre. It wanted to know: what arrangements the government made to supply water to Elementaita trading centre when the railway abandoned that line. How much was allocated out of 71,000 pounds for the trading centre and know the balance if any. Lastly, what would the government do if Lord Delamere revoked the agreement. The council was desperate to have the information and requested for planning the improvements at the centre. Everything depended on the water supply³⁷⁶.

Regardless, the council felt that some of the 71,000 pounds was not spent. The district engineer informed the council that 85 percent had been spent on the water supply since relinquishment by the railway. Mr Wainwright, the provincial commissioner enquired over the full amount paid and the balance that was available. Wainwright gathered that all the 71,000 pounds received from the East Africa Railways and Harbours was spent on the roads. The water supply was installed with funds obtained from supplementary estimate. A case of misappropriation was evidently demonstrated³⁷⁷.

374 Perreau W. A (1955). Elementaita Water supply. Kenya National Archives, PC/NKU/2/25/31 Ref: CC.8/2/958. 19th April 1955.

375 Perreau W. A (1955). Elementaita Water supply. Kenya National Archives, PC/NKU/2/25/31 Ref: CC.8/2/958. 19th April 1955.

376 Perreau W. A (1955). Elementaita Water supply. Kenya National Archives, PC/NKU/2/25/31 Ref: CC.8/2/958. 19th April 1955.

377 Wainwright R. E 1955. Elementaita Water Supply. Kenya National Archives, PC/NKU/2/25/31 Ref: Pw.8/3/169, 15th May 1955.

However, the government considered the Elementaita supply too small to operate economically as a public supply. The PC gave two alternatives to augment the supply; to continue the existing unsatisfactory arrangement with minor improvements or installation of a new supply, operated by the council appointed as water undertakers³⁷⁸.

In a meeting of Water Resources Authority priorities committee, the committee considered the proposal to install an augmented water supply at Elementaita trading centre and rejected the proposal. This was because of the cost of the scheme, the existence of a water supply and low demand for water. The water resources then met and confirmed the recommendations of the priorities committee, which the minister for agriculture accepted. The secretary for agriculture advised the provincial commissioner to put a stronger case for construction of a borehole due to real hardships emanating from lack of one³⁷⁹.

Londiani Water Supply: Just like many other water supplies in townships situated along the railway line, Londiani derived its first water supply from that initially constructed by the railway. It is not clear at what time the railway put up the water supply at Londiani, however the supply was composed of water sourced at springs located in the forest and gravitated down to a group of tanks at the Londiani railway station.

The supply from the spring seems to have been ample, judging from the nuisance report by the Resident Commissioner 1929 as having been caused by the overflow from the railway tanks, which had formed a swamp outside the railway reserve and thus creating a health hazard from mosquito breeding.

It was this realization that led the then Resident Commissioner Mr. Hosking to initiate a small project to pipe the overflow water to tanks in the township to serve its residents. Hosking then wrote to the acting GM, Kenya Uganda Railways for permission to pipe the overflow water for the use of the Londiani township residents.

Hosking then reconditioned some old boiler shells and send them to Londiani to serve as water tanks. Two residents namely H.B. Atkinson and Mr. Daulatram Kobili who owned a Londiani Hotel and Londiani stores respectively were most helpful in installation of the water supply. While the railway offered to pipe the water out of the railway reserve, the bought all the piping and accessories and shipped them to Londiani by railway from Mombasa. With the piping ready and the second hand steel boiler shells on hand, the KURH provided the money to meet the cost

378 Wainwright, R. E (1955). Elementaita Water Supply Kenya National Archives, PC/NKU/2/25/31 Ref: PW/3/175, 29th June 1955

379 For Secretary for Agriculture (1955). Elementaita Water Supply. Kenya National Archives, PC/NKU/2/25/31. Ref: WAT.36/6/5/7/61. 19th October 1955

of laying the pipes. By the end of 1929 the water supply was in place serving the Londiani Hotel and stores, the post office, Police lines and the Londiani residents who fetched the water by use of debes.

Kilgoris Water Supply: Kilgoris is located 60Km north of Kisii in Narok District, Rift Valley Province, approximately 430km from Nairobi. By 1983, there were three water supplies serving Kilgoris Centre. The supplies were unreliable and the water of poor quality. A new project was completed in 1983. In 1993, a new scheme was completed. The water demand and population projections by 1983 were as shown in Table 3.22.

Table 3.22: Population and water demand projections by 1983 in Kilgoris

Year	1980	1986	1996
Population	3100	4250	7300
Water demand (m ³ per day)	235	355	600
Individual Connections (%)	-	60	70
Water Kiosks (%)	-	40	30

A new scheme was designed to treat the ultimate demand of 600 m³ per hour at 16 hours operation per day. It comprised of impounding weir on Langata Ngima River giving storage of approximately 4000 m³ at a rate of 520 m³ per day, raw water intake with centrifugal pumps, flocculation basins, rapid gravity filters, balancing tank, chemical dosing equipment and high lift pumping³⁸⁰.

The distribution system involved pumping water from the treatment plant to a 300 m³ storage tank through a 1.6km long pumping line, with dimension 150mm, and pressure classes B to E.

A reticulation system with a total of 6 Km was used. The water gravitated from the storage tank to the Kilgoris rural centre and the adjacent areas. The rural areas were supplied through six communal water points, other areas by individual connections. The delay in acquiring high lift pumps was because of difficulties with obtaining import licences for pumps and equipment required.

The operation of the scheme was fully dependent on the generating set installed. When the project was designed, it was assumed that electricity supply would be available within 1982/1983, and one generator was sufficient for the limited period. However, the availability of electricity was postponed until 1985/6 and there were

380 Hunn G (1983). Progress Report About water Projects included in the Minor Urban Water Supply Programme. NORAD –Coordinator/MOWD. Nairobi Ref: WD/1/2/5. 10th June 1983.

operational difficulties. The cost of bringing electricity was estimated at 3 million Kenya shillings³⁸¹.

3.3.2.4 North Eastern Province Water Supplies

Garissa Water Supply: The population of the Garissa district by 1943 was approximately 79,000. About 21,700 people lived nomadic life, 52,000 practiced agriculture and lived along the banks of River Tana. There were about 150,000 cattle, 350,000 sheep and goats, and 5,000 camels. The rainfall in the year 1942/43 was the worst recorded since 1914. The DC appreciated the importance of tribesmen contribution to development works by digging pans. This, he argued was the only way to make any meaningful contribution to water development works. Prolonging and increasing the local supplies was important to enable the population spread out over a great area³⁸².

The movement of stock took place from River Tana, Lorian plains, Sabenha, and area near Benane springs in dry weather. While during wet weather, the stock moved from there into the centre i.e. South Lorian plains, Kurde, Rama Guda, and Fafi Rama (wet weather grazing areas). Boreholes were constructed for dry period only to prevent the tribesmen from settling around them permanently. Water was required primarily for stock for the tribesmen could even drink saline water³⁸³.

In 1943, Garissa administrative station had no water supply. It drew muddy water in tins from River Tana. The DC employed a full time boy to draw water, treat it with alum and pour into tanks. The District commissioners before 1943 had put up schemes for the unit but none materialized. During the war, the military had erected some water points at several places but later removed them. The DC recommended obtaining water from the side of a river with a windmill and proposed the use of the piping left behind by the military³⁸⁴.

Dams: Ijara, which had four large pools, was the only dam. It was cleaned out in July 1942 and there were no more sites found suitable for dam construction. The government undertook no new works during 1943 in Garissa district. In November 1943, sudden heavy rainfall fell stopping any work to take place at the four ponds

381 Hunn G (1983). Progress Report About water Projects included in the Minor Urban Water Supply Programme. NORAD –Coordinator/MOWD. Nairobi Ref: WD/1/2/5. 10th June 1983.

382 District Commissioner Garissa, (1944). Memo on Water Supplies in Garissa District Kenya National Archives. GRSSA/6/3, 1944.

383 District Commissioner Garissa, (1944). Memo on Water Supplies in Garissa District Kenya National Archives. GRSSA/6/3, 1944.

384 District Commissioner Garissa, (1944). Memo on Water Supplies in Garissa District Kenya National Archives. GRSSA/6/3, 1944.

of Ijara The District Commissioner attributed this to extreme drought and heavy sudden rainfall, which made work impossible, and unwillingness of the Somalis to do manual labour³⁸⁵.

Wells in Garissa: In Galana Gof, Lak Dera and other dry riverbed wells: these were dug by tribesmen in the dry riverbeds. They were occasionally destroyed by heavy flow.

Bangali: There were about six well of 3.6 to 4.6 metre deep in the form of craters existing at Bangali.

Garissa station: various district commissioners had dug wells but the only place that produced water was the grove of trees and the DC's vegetable garden.

Boreholes: As at June 1943, following boreholes were examined in Garissa: Liboi, Galmala, Kolbio and Hagar Dera. The military made all these boreholes and each had only one shaft remaining by the time of examination. Kolbio was 46 metre deep while Hagar Dera was useful both for holding Somali stock and as a centre for grazing.

Chemevix, the District Commissioner evaluated the disadvantages of boreholes, wells and dams in the district. He observed that boreholes were costly to construct and attracted tribesmen to settle permanently in the vicinity and dams were semi-permanent and were frequently destroyed by elephants and cattle. Wells were mostly constructed in dry rivers in the district and a heavy flow destroyed them. He recommended reopening of three boreholes that had stalled³⁸⁶.

According to the Dixey report, by 1946, there were only four boreholes in Garissa District. Three were under use. These were³⁸⁷.

Liboi Borehole: The borehole was used by the Somali tribesmen for watering stock and drinking, it was used for easing tribal conflict caused by issues related to ownership of water points and by immigrants wishing to enter the colony. In 1947, the public works department stopped operating the borehole at Galmagalla. This was because the water was very saline and ate away the pump washers rapidly and animals too could not drink the water. In mid-1948 the PWD administrative secretary requested for an early examination of the Liboi borehole with a view to its restoration³⁸⁸. The refurbishment work started in 1949³⁸⁹. The work was expected

385 Hall W.H (1944). Dams: construction and Maintenance of, Kenya National Archives., GRSSA/6/3, Ref: ND.16/4 /3, 2nd February 1944.

386 District Commissioner, Garissa (1950) Construction of Rainwater Catchment Tanks, Kenya National Archives. DC/GRSSA/6/13, Ref: PW. 8/4/2, 19th December 1950.

387 Stevens A. J (1946). Borehole Kolbio, K.N.A., GRSSA/6/3, Ref: 8/4/2. 11th June 1946.

388 Govier A. R. C (1949). Construction of a borehole and pump installation at Liboi Kenya National Archives., GRSSA/6/3, Ref: 5/17/1/49, 11th July 1949.

389 Govier A. R. C (1949). Construction of a borehole and pump installation at Liboi Kenya National Archives., GRSSA/6/3, Ref: 5/17/1/49, 11th July 1949.

to be completed in the same year. In 1949, Davis & Shirtliff Ltd was tendered to repair the Liboi Borehole. The company was also supposed to repair the Garissa water point and the Hagadira borehole³⁹⁰.

The Three-Year Water Development Scheme: The total expenses for the scheme for three years (from 1949 to July 1951) were 38,138 shillings. These included maintenance and repair of the lorry tractor, tools and equipment and contingencies³⁹¹.

Under the scheme, in 1950, four water tanks were dug in Garissa district. A tractor, a mull dozer and later a rotary scraper and a gang of 25 men equipped with hand tools did the work.

Circular tanks were constructed. The first tank was too wide and shallow hence unsuccessful. Other tanks were roughly 100ft in diameter and 8 ft. deep at the centre with further 30 ft. round the edge cleared down to depth of half a metre. The procedure for the work involved, truck cutting and site clearing with a mull dozer while labour dug inlet channels to the pan. The mull dozer and the labour dug excavation of the centre of the pan³⁹².

Pan Digging: Pan digging at Ega Kamol, Yimbis, Kamor Jila, Arbeli, Dad Senab and Hani had been completed by July 1951. Ega Kamol was the first pan dug. It was a failure as it was too wide and thus very high rate of evaporation. Yimbis was 90ft in diameter by 7ft deep and held about 250,000 gallons when full. The area round which the pan was had little rainfall and the pan was never full. Kemor Jila had similar pattern to Yimbis and was open for stock. Dad Senab had a similar pattern to Yimbis was successful and held a lot of water. Hani pattern was just like Yimbis and Dab Senab, Classen advised a change to a trough of 130ft long by 20ft wide. A Tractor dug the pan. However, it was the first to dry, due to penetration of the clay underneath while digging and invasion by elephants were suspected³⁹³.

The pans were important in keeping the stock away from grazing on the river banks and near the boreholes as long as possible. The District Commissioner recommended digging more pans towards southeast. The Northern part of Garissa-Hagardera road and south of Bura-Kolbio road was better off and did not need

390 Director, Davis & Shirtliff Ltd (1949). Water Supplies, Kenya National Archives, GRSSA/6/3, 5th September 1949.

391 Chemevix T (1951). Garissa Three-Year Water Development Scheme, Kenya National Archives. DC/GRSSA/6/13, Ref: PW.8/4/2, 4th July 1951.

392 District Commissioner, Garissa (1950) Construction of Rainwater Catchment Tanks, Kenya National Archives. DC/GRSSA/6/13, Ref: PW. 8/4/2, 19th December 1950.

393 Chemevix T (1951). Garissa Three-Year Water Development Scheme, K.N.A. DC/GRSSA/6/13, Ref: PW.8/4/2, 4th July 1951.

pans. The rain was normally scattered and patchy; more pans were recommended to promote chances of collecting more water³⁹⁴.

There were several problems experienced then: High cost of transport and maintenance of the lorry, lazy and ignorant driver and turn-boy; inefficient tractor; and non-payment of wages, and the gang was not paid for six months in 1951. This caused reluctance and henceforth work slowdown.

Chemevix was against unpaid labour and considered it more costly than working on a paid gang. Unpaid labour took more time, more supervision, more cost of transport (transporting water, rations, inspecting officers etc.). He proposed a payment plan whereby the gang got one-month wages for completing a pan regardless of time spent working on the pan³⁹⁵.

The Classen Report: In 1951, Engineer Classen investigated the water supply system in Garissa and designed a development plan. The object of the development plan for this district was to provide temporary water storage along a line of about 80 kilometres away from Tana River. This delayed the return of stock to the permanent water after the rains and made full use of the grazing. He recommended improvement of pans by digging tanks where none existed. Classen established that except in few places where loose fine sand covered the surface, the hard red soils, covering most of the area was suitable for both forms of storage. He further advised on preservation of grass cover in the channels and enlargement of the last storage as much as possible.

The area between Garissa and Muddo Gashi had numerous good sites for tanks and improved pans. Furthermore, some of the larger stream channels on the road from Muddo Gashi to Saka had good sub surface dams and wells. Sub surface dams were built by cleaning out the bottom of the streambed as down as possible and removing the heavy sand. A masonry wall was then built to a height of about a foot above the original level of the sand. The sand, which collected behind the wall, retained floodwater brought down during the rains, and the water was available by digging a simple water hole.

Mr. Classen noted that wells down into the underlying rock were very successful especially towards the end of Lorian Swamp. The yield from these wells was not high, five or more wells could provide appreciable amount.

Mills, the district commissioner, observed that the consumption of water from a piped supply was always higher in comparison to other supplies. The military water supply system provided approximately 9 m³. Regardless, Mills received numerous

394 Chemevix T (1951). Report On Three-Year Water Development Scheme-1st January till 30th June 1951, K.N.A. DC/GRSSA/6/13, Ref: PW.8/4/2, 19th June 1951.

395 Chemevix T (1951). Report On Three-Year Water Development Scheme-1st January till 30th June 1951, Kenya National Archives. DC/GRSSA/6/13, Ref: PW.8/4/2, 19th June 1951.

complaints from government staff and local inhabitants over insufficient water. As a solution he suggested that the government should start a new water supply at a cost of 5,000 pounds to augment military supply which was approximately 7,500 gallons³⁹⁶.

Mills observed that European and Asian staff only, needed connection to the supplies while the supply to the shops and other areas required kiosk supply. He considered a supply to individuals, wastage of water. Mills proposed provision of standpipes with storage tanks for the hospital, police and tribal police lines and prison. The estimates included water operator house and a small store. They envisaged charges at the rate of 5 shillings per 4.5 m³ and 3 or 4 cents per 4.5 litres at the kiosk. The scheme was urgent and the executive engineer was expected in Garissa by the end of 1951 to start the work³⁹⁷.

In its meeting of March 1953, the Water resources Authority allocated the Garissa Water Scheme Priority 'A' for construction with the availability of funds expected from the Development and Reconstruction Authority (D.A.R.A). The construction was expected to commence in 1953³⁹⁸.

Water Charges: Under section, 153 of the water Ordinance 1951, and with the approval of the Minister for Agriculture Animal Husbandry and Natural Resources, the director of public works made amendments to the regulation and schedules. They took financial effect from the first water accounts issued after 31st December 1956³⁹⁹.

According to the amendments, wherever a metre was installed, a monthly rent, became payable at 2.50 to 10 shillings, corresponding to the nominal size of the metre i.e. from half-inch size metre up to three-inch size metre. Where metres in excess of 3-inch size were used, a special metre rate was fixed based on 1.25% of the installed cost. The minimum charges for a metered connection without a metre rent ranged from 7.50 to 10.00 shillings. The standard tariffs applied according to the purpose and whether or not a metre was installed. Where no metre was installed, monthly charges ranged from 10 to 20 shillings for domestic use and rate of 40 to 80 shillings charged for building purposes. Where metres were installed, three to five shillings, according to the type of tariff, per 4.5 m³ of water used were charged monthly.

396 Mills R. C (1952). Water Supply Garissa, Kenya National Archives, DC/GRSSA/6/13, Ref: PW. 8/4/60, 5th February 1952.

397 Mills R. C (1952). Garissa Water Supply, Kenya National Archives, DC/GRSSA/6/13, Ref: PW. 8/4/48, 16th November 1952.

398 Member for Agriculture & Natural Resources (1953 Kenya National Archives. DC/GRSSA/6/10, Ref: WAT36/9/146, 10th June 1953.

399 Brown J. L (1956). The Water Ordinance, 1951, Kenya National Archives. DC/GRSSA/6/13, Ref: Gazette Notice No. 3566, 21st November 1956.

Water sold from a kiosk or through a licensed retailer, charges ranged from 0.2 to 0.3 cents per 18 litres.

For water sold in excess of 136.4 m³ through one metre in any one month a charge of KES 2.40 to 3.20 per 4.5 m³ in excess of 136.4m³ was chargeable. Bulk rate only applied at water supplies specifically gazetted as allowing a bulk rate.

In 1959, Garissa, Marsabit, Isiolo and Lodwar had piped water supplies. The government employees paid according to the consumption recorded by metres. Where metres were not fitted a flat rate was charged⁴⁰⁰.

Metre problems: By 1959, Water supply for Garissa was from seepage wells. The amount of water pump-able depended largely on the level of the river and the state of the weather. The years 1958 and 1959 experience severe draught hence insufficient water in the wells to meet the consumer demands. The pumps were pumping a lot of air and the metres continued recording leading to numerous complaints from the consumers. Consumers went without water for some time whereas metres continued to register. Though the government boma was on a separate reticulation, it suffered the effect of the drought. The district commissioner considered the fairest arrangement was to charge consumers half the amount of water registered by the metres from 1958. Alternatively, a flat rate decided⁴⁰¹.

Wajir Water Supply: Wajir Town is situated approximately 637 kilometres North East of Nairobi measured along Nairobi-Isiolo-Wajir Road. Wajir Township was situated in the centre of the province with roads at the borders. The district is flat with a slope towards the southeast. Roads leading to El Wak and Moyale were at the Northern and North-eastern sides. Wajir had two ridges of hills, those to the northwest being of basement complex, sedimentary lime in the northeast and sand stones towards southeast. The flat areas of the district consisted of sedimentary strata with clays predominating in the south⁴⁰².

The district was a predominantly camel country though it was difficult to obtain reliable figures. Estimates ranged from 125,000 to 700,000 and above. There were about 30,000 cattle in the district. Elephants, which could go without water for some months, were found in the hills of Butellu⁴⁰³. Government efforts to augment water in this district started on earnest in 1935 with development of natives grazing

400 Provincial Commissioner, Northern Province (1959). Water Charges, Establishment Circular NO. 35 of 1958, Kenya National Archives. DC/GRSSA/6/13, Ref: FIN.4/18/23, 6th January 1959.

401 Souta A (1959). Garissa Water Supply, Kenya National Archives. DC/GRSSA/6/13, Ref: PW.8/4/11/535, 6th June 1959.

402 Resident Engineer (1952). Possibilities of Water in Wajir District, Kenya National Archives, PC/GRSSA/20/20, 1st October 1952..

403 Resident Engineer (1952). Possibilities of Water in Wajir District, Kenya National Archives, PC/GRSSA/20/20, 1st October 1952.

areas. The role of the District Commissioner and the Provincial Commissioner were crucial in the district water development. The District Commissioner at the grassroots planned, controlled and maintained water use in the district. However, efforts by the Africans could not be underrated, personal efforts by the Ajuran to maintain the wells at Buna were an instance of this.

In 1924, all the wells around Wajir district were counted and a total of 267 arrived at. El Arbo had 130 wells, El Nur Abiki 39, El Shilati 32, Mukaror 23, other twelve stations had less than ten wells⁴⁰⁴. However, in 1932, the Borans were moved from the Wajir District and the greater part of these wells fell into disuse and became silted. This was because the Somalis were too lazy to keep them up. It was established that cleaning them was easy. There were wells also at Wajir Bor and Eil Tulli but they were impregnated with sulphur and were very temporary. By 1936, there were only 20 wells outside Wajir boma constantly in use. However, there was a large number at Arbe, Bangal, NurAbikar, and Makror used during the dry season. These temporary wells were exposed to silting during the rains⁴⁰⁵.

In 1935 the need to develop the native areas in the district was felt. The District Commissioner considered the work that benefited the tribesmen to be⁴⁰⁶:

- Installation of pipes at the deepest wells thus obviating the necessity for 17 or 18 individuals to form a chain and get the water out in buckets.
- The building of cement trough at the wells for the stock.
- The construction of a low well round the mouths to prevent water pollution, dung and sand constantly flowing into the well.
- Deepening the water pans and a careful examination as to which pans could be improved.

There were some 60 or more wells at and around Wajir that required cementing. The approximate cost of cementing these wells was 18 shilling per well. The cost of cementing a small well of half a metre high and half a metre broad round the top was 13 shillings. Cementing involved covering the mixture of rocks and lime with cement coat of half-inch thick. Due to transport costs, the undertaking was expected to be very expensive⁴⁰⁷.

404 Provincial Commissioner Isiolo (1939). Wells at Wajir, Kenya National Archives PC/GRSSA/2/20, Ref: PW.8/4/9/919, 23rd September 1939.

405 Provincial Commissioner Isiolo (1939). Wells at Wajir, Kenya National Archives PC/GRSSA/2/20, Ref: PW.8/4/9/919, 23rd September 1939.

406 District Commissioner Wajir (1935). Water Supplies in Native Areas Kenya National Archives, PC/GRSSA/2/20/20, Ref: PW.8/4/1/851, Water, 30th October 1935.

407 District Commissioner Wajir (1935). Water Supplies in Native Areas Kenya National Archives, PC/GRSSA/2/20/20, Ref: PW.8/4/1/851, Water, 30th October 1935.

In March 1946, the Wajir, Garissa and Isiolo District Commissioners inspected Habaswein Bridge. They found that the Gashi tribe had spread out along the riverbed. Water was available in small quantities six feet below the riverbed. Elephants frequently ruined the Gashi wells and forced them to move away. To the east of Habaswein Bridge in the Lorian swamp the situation was more serious, because of the large number of people and stock present. Water was dug at the depth of about nine metres but was scarcely enough⁴⁰⁸.

By 1944, Wajir had only four boreholes, three situated 11 kilometres south of Habaswein Bridge and one at Wajir Bor. The borehole at Wajir Bor was filled with stones and was useless unless bored afresh. At Habaswein, one borehole was revivable by use of oil engine. The military authorities had also sunk a very deep well at this site⁴⁰⁹.

Through government instigation, pans in Wajir district were constructed or cleaned in the period between April 1945 and October 1946. Lak Boggal pan was the best pan in the district.

Overall, three water pans were completed, two were enlarged and four existing well tops were renovated at the North West corner in 1946. Five extra new well tops, with drinking troughs were built at El Shelleti and Wichir respectively. The District Commissioner anticipated no additional work in the year. Any extra sitting and digging of pans were to be made as per the recommendations of Dixey report. As many as possible wells were to be cleaned out and provided with tops and drinking troughs. To reduce the concentration of stock close to the station, cementing of wells at some distance from the boma, was proposed⁴¹⁰.

In 1947, a proposal to supply water to the government quarters in Wajir was made. Seven staff quarters were to be supplied with water. High cost of installation due to large gauge piping to overcome silt deposition, and 500% increase in consumption per household was anticipated. The condition was difficult to cope with. An alternative proposal was that each quarter should get its own well. This was possible since water could be found everywhere in the station whenever dug and the local fundis were available. The cost of digging a well and providing a simple wellhead was Kenya Shillings 200. This scheme could save time and labour spent

408 Derric F. P. B (1947). Water Supply to Staff Quarters in Wajir, Kenya, National Archives PC/GRS-SA/2/20, Ref PW.8/4/200, 7th April 1947.

409 District Commissioner, Wajir (1944). Boreholes, Kenya National Archives, PC/GRSSA/2/20, Ref: P. W8/4, 1st December 1944.

410 District Commissioner, Isiolo (1946). Report on Water Shortage Habaswein Area, Kenya National Archives PC/GRSSA/2/20, Ref: P.W.8/7/135 19th March 1946.

by prisoners to fetch water for the government staffs. The prisoners spent three or four hours fetching and carting water in 200 litre drums⁴¹¹.

The resident engineer was mandated to investigate and come up with the report on water situation in Wajir and recommendations thereof. The first report on the Degodia country to the north of Wajir was complete by October 1952. The second on the Ajuran and Ogaden areas was completed in March 1953. Investigations up to 1952 showed that the public works department had carried considerable geophysical investigation and followed it up by digging of exploratory wells. The investigation of surface supplies was confined to hills. The report divided Wajir into two main areas, the Degodia country to the north of Wajir and the Ajuran and Ogaden area⁴¹².

According to the interim report of Resident engineer on the water supply in 1952, Wajir had 480 wells and was the subject of investigation by the public works department. Generally, the wells were situated within a radius of 8 kilometres from the boma. These wells together with the ones in the east (Wajir Bor) area were the only large sources of permanent supply in the district. Due to falling water table, some of the wells dried up. Very few of these wells had more than six inches of water. In the North, the wells in the basement complex were the only supply capable of supporting the stocks. From this area 100% of the stock watered at Wajir. During the dry period, camels were watered once in three weeks. They consumed 30 to 40 gallons per visit.

The resident engineer recommended cleaning out the dams and pans, deepening and provision of audits where necessary, excavation of lined reservoirs to hold the available supply and, construction of dams with various capacities. This was proposed in four different areas i.e. Tarbaj, Mansa, Ali Gollo and Dela (Buna road) area. The resident engineer stressed that the principle was to keep all camels away from Wajir Township through provision of sufficient water. There were about 80,000 camels requiring about 11365 m³ of water per day during the dry months. Since this was unattainable it was proposed that about 50% of the camels be kept away from Wajir Township.

The annual maintenance cost of one reservoir was approximately 10 shillings. The total annual cost of augmenting the water supplies in Degodia country to the north of Wajir was estimated to about KES 260,000⁴¹³.

411 Derric F.P.B (1947). Water Supply to Staff Quarters in Wajir, Kenya, National Archives PC/GRS-SA/2/20, Ref PW.8/4/200, 7th April 1947.

412 Resident Engineer Nanyuki (1953). Wajir District, Kenya National Archives, PC/GRSSA/20/20, Ref: AK14/, 10th March 1953 .

413 Koch B.R.C (1953). Inspection Report, Kenya National Archives. DC/15/3/4/43, Ref: PW.8/27, 13th October 1953.

Mr. Forward of Messrs Howard Humphrey's and sons, Mr. Middleton Stewart, resident engineer Mr. B.R.C Koch, deputy hydraulic engineer visited Wajir and Moyale districts. They inspected the progress of the Dixey scheme and discussed the general problems. The tour assisted Koch to appreciate the problems associated with the work⁴¹⁴. El Ben was dug in the bed of a pan and was flooded by the time of inspection because of rains. Abdi Gani was a group of very closely spaced ancient dry wells near El Ben. They had been used for some decades and then abandoned probably due to failure of aquifer. Singu was a site for an excavated tank-cum-storage dam. Floods had occasionally destroyed the wall. They proposed an excavation of the tank alongside the Lugga so that Lugga formed the spillway. At Afiat an earth storage dam across a large river was nearing completion. It had a good capacity and had been full in for some time then past. Large numbers of camels present consumed the water rapidly⁴¹⁵.

The catchment area in Mansa Dika was small but much eroded and was almost a bare rock. This made it possible to construct a tank with almost vertical sides, which reduced the evaporation surface. A group of wells was being developed at Giriftu. Two successful wells had been excavated but tribesmen had used them dry. The standard of workmanship was excellent. Local tribes were inspired by the construction engineer's team and started digging their own wells. Muddo A well was being sunk alongside a watercourse known as Lak Bor. The progress was little but had promising success⁴¹⁶.

By 1954, a total of 625 government servants in Wajir depended on piped water supply scheme. These were 348 in the administration department, 114 in the police and 163 in the medical department. However the District Commissioner was sceptical that piped water could never be reliable since numerous wells in the boma had very little water⁴¹⁷.

According to establishment circular no 35 of 1958; Garissa, Marsabit, Isiolo and Lodwar stations had piped water supplies. The government employees in the township paid for water according to the consumption recorded by metres. Mandera had a borehole supply though water was not fit for human consumption and cooking. Water for these purposes was brought from Daua River in Lokitaung and Wajir. The wives of the askaris etc. drew their own water from the wells. In Moyale,

414 Koch B.R.C (1953). Inspection Report, Kenya National Archives. DC/15/3/4/43, Ref: PW.8/27, 13th October 1953.

415 Koch B.R.C (1953). Inspection Report, Kenya National Archives. DC/15/3/4/43, Ref: PW.8/27, 13th October 1953.

416 Koch B.R.C (1953). Inspection Report, Kenya National Archives. DC/15/3/4/43, Ref: PW.8/27, 13th October 1953.

417 Elliott J.M (1954) Piped Water Supply for Wajir Boma, Kenya National Archives. PC/GRS-SA/3/23/13, Ref: PW.8/6/4/64, 30th October 1954.

because of the distance water was distributed to the tanks from which women drew it. In all cases the water was untreated, rationed and often mineralized⁴¹⁸.

There was no major government project undertaken in Wajir but general works of digging and improving wells boreholes and pans. This was probably because of availability of many water sources within the district. As in comparison to other Frontier districts Wajir received low government commitment and small budgetary allocation. The implementation of Dixey scheme had not taken place by 1961 (according to the available records). Only little augmentation work in the district was done communally and no instance of compulsory labour was reported.

The population of Wajir by 1983 was 10,000 people which included 6500 people living in Manyattas and 1000 headsmen residing for three months every year.

The MoWD engaged an Israeli consultant, Balash Jalon for designing a joint water and sewerage project for Wajir. The consultant submitted separate Preliminary Design Reports for water and sewerage in June 1976 which had not been completed by 1983.

The PDR report indicated that the only possible water supply sources were the groundwater aquifers underlying Wajir. The water from numerous wells in Wajir was drawn from the upper aquifer. It was predicted that the existing water supply system would represent water supply system for many years and therefore required protection from pollution. Water was mainly collected by rope and buckets from open individual wells and only few institutions and some individuals had piped water. Two diesel pumps and one solar pump were operated by the MoWD. Four wind mill pumps were operated by others. MoWD was making some wells installing pumps and extending some pipes. All water pumping was done from an open well.

Mandera Water Supply: In 1947, Mandera Township was supplied from the Daua River by means of thirty donkeys. The river was two miles from the Mandera town. The administrative unit, otherwise known as the boma had a maximum African population of five hundred men, women and children. There were also five European officers, three Goans and one Arab clerk. The population depended on water fetched by 16 camels requisitioned regularly from different tribes. The camels carried approximately 1,600 gallons of water then transported it for two miles to Mandera every day. According to the report of the District Commissioner, the amount provided the average population of the boma with 5 gallons per head per day. This

418 PC Isiolo (1959), Water Charges, National Archives, PC/GRSSA/3/23/13, Ref: FIN.4/18/23, 6th January 1959.

catered for all the uses. In addition, the Government supplied 32 very expensive barramils for carrying water and numerous drums and tanks used as receptacles⁴¹⁹.

Water Improvement Efforts: The first proposal came up as a result of perennial water shortage and particularly the acute shortage experienced in 1946. In January 1946, the Daua River almost dried up. The water level in the well diminished to 29 ft. The District Commissioner urgently needed a water pump to help improve the water situation. The Gailey & Roberts Ltd, Hydraulic Department, quoted a diesel pump capable of drawing 5,000 gallons per day. It was supposed to pump water for two miles up a 100-foot rise to the township and the boma⁴²⁰.

Second proposal: The second proposal in February 1947 was a power driven water supply system. A supply installed and connected to both the boma and township piping was envisaged. It was also expected to serve the whole community through three or four distribution points. The approximate cost for this project was 5,284 pounds.

The District Commissioner expected the scheme to pay back in ten years' time. This was possible in assumption that the average cost of water for Government servants was 300 pounds. The rates of 10/- for a residential plot and 20/- for a trading plot were proposed. The returns were expected to rise as more people took up plots and started water consumption⁴²¹.

When His Excellency visited Mandera in February 1947, he gave orders to start water schemes fastest possible. He found the existing water supply method most undesirable. He was apprehensive about tribesmen's camels being hired against their will and worked hard without grazing. He was concerned of the substantial expense involved. Consequently, the Provincial Commissioner made an application to the Ministry of Agriculture for the 250 pounds to improve the supply to the Government staff⁴²².

The Water Resources authority met in June 1948 and discussed the issue of Mandera Water Supply. The Priorities Committee felt that Mandera deserved first priority in water provision.

However, large distance and staff involvement in other projects were the major setbacks. There were great difficulties in transporting the dispatch of piping and

419 District Commissioner, Mandera (1947). Mandera Water Supply. Kenya National Archives, Provincial Commissioner/GRSSA/2/20/22. Ref: PW.8/4, 24th February 1947.

420 District Commissioner, Mandera (1946). Water Supply- Mandera. Kenya National Archives, PC/GRSSA/2/20/22, Ref: PW.8/4/1/188, 24th January 1946.

421 District Commissioner, Mandera (1947). Mandera Water Supply. Kenya National Archives, PC/GRSSA/2/20/22. Ref: PW.8/4, 24th February 1947.

422 Pinney J (1947). Mandera Water Supply. Kenya National Archives, PC/GRSSA/2/20/22, Ref:8/4/9/27, 23rd September 1947.

plant. The only hope for the township was left to an early implementation of the Dixey's Scheme⁴²³.

By 1953 Mandera district was hopelessly under watered. The Provincial Commissioner Mr. Kennaway acknowledged that additional water supplies caused political problems due to migration. As a result the unmanageable number of animals complicated grazing. All the same, he was confident of his ability to resolve consequent political challenges. Mandera had only two supplies about a hundred and sixty kilometres apart. The PC argued that political factors had to be taken in to consideration in all the Frontier areas for any meaningful development in the district to take place⁴²⁴.

Investigational boring took place in 1956 as advised by Mr. Bestow, a geophysicist. There was a possibility of getting water at a depth of 43 to 85 metres. The Chief Secretary and the Minister for Defence supported the proposal and suggested a trial bore in three months. The PC indicated that Dixey Scheme engineers could undertake the task if funds were made available in mid-April, 1956. To ensure trials were completed before the end of the financial year, the PC requested a sum of 500pounds from the African Trust Fund⁴²⁵.

The first borehole was successfully drilled in October 1956 in Mandera boma. It yielded 4546 litres 5678 litres of palatable water per hour. This supply was meant for the government servants and their families and not for the township and the general members of the public. Since the water was palatable the Provincial Commissioner felt that water treatment was not necessary. He however, pleaded more funds for reticulation⁴²⁶.

Declining Water Supply: In November 1959 Daua River had dried up. The inhabitants were forced to drink saline borehole waters. The water situation grew worse and by June 1960, the yield of the Mandera boreholes fell significantly ever since they started operation.

The Mandera District Commissioner, proposed an installation of rain storage tanks and roof guttering to augment the supplies. He proposed the exercise be carried out in the boma, in all new buildings and in institutions like school, jail etc. This was expected to help ease dependence on the Daua River, which occasionally dried up. He observed that the underground supply was plentiful such that for ten

423 Member for Agriculture and Natural Resources (1948) Kenya National Archives, PC/GRSSA/2/20/22, Ref no; 20/21/1/16, 22nd June 1948.

424 Provincial Commissioner, Isiolo (1958). Proposal for Township Kiosk. Kenya National Archives, PC/GRSSA/2/20/22, Ref PW.8/4/9/192, 6th November 1958.

425 Kennaway N.F (1956). Mandera Water Supply. Kenya National Archives, PC/GRSSA/2/20/22, Ref: PW.8/4/9/148, 20th October 1956.

426 Kennaway N.F (1956). Mandera Water Supply. Kenya National Archives, PC/GRSSA/2/20/22, Ref: PW.8/4/9/148, 20th October 1956.

months, water was available in the rivers and for the remaining two months it could be found beneath the sand. Therefore sustainability was possible throughout the year. The DC further noted that the police lines had almost been excluded from the supply and action was imperative⁴²⁷.

However, the major setback towards the augmentation was that Africans were not permitted to erect pumps on the El Wak wells. This undermined the intentions of the police to install a Rotary Hand Pump on the police well at El Wak Fort, in July 1961. The DC was anxious that if the consent were given, more requests from the Africans would come up and would end up waiving the long-standing rule regarding Public wells⁴²⁸.

The army water supply was completed in 1968. It covered an area of 25km² and produced 200 m³ per day. The pipeline had a length was of about 5 kilometres and a diameter of 3 inches.

Arabia water supply was completed in 1970 and covered about 25km². The supply produced 200m³ per day. It had a four-kilometre long, three-inch diameter pipeline with dosing equipment. In all these four supplies within the district: treatment was done through chlorination, the supplies had one diesel engine, a pump, staff quarter and dosing equipment.

By February 1970, the design for the Rhamu water supply was completed and funds released while pumps were being purchased and transported to Rhamu. A total of 1,100pounds for labour and 500pounds for transport were issued. The funds came from a Swedish loan, which imposed special accounting responsibilities.

Classen advised on disbursement of 1,100pounds to the Mandera DC minus the transport cost since the district had ample transport.

In 1970, the district water development officer confirmed the completion of Rhamu water scheme. The supply distributed water to the various water points for the consumers and the following points were served. The village with 8 water points, the trading centre with 4, police lines, administration centre and the school each with two and lastly the dispensary with one water point. People of Rhamu were happy and thankful to the government⁴²⁹.

The District Commissioner, C. Kisaka, pleaded for a minister ceremonial opening in order to boost the morale and the Harambee spirit of the people in the

427 Cashmore T.H.R (1961). Water Supplies Mandera Boma. Kenya National Archives, Provincial Commissioner/GRSSA/2/20/22, Ref: PW.8/4/139. 26th January 1961.

428 Cashmore T.H.R (1961). Water Supplies Mandera Boma. Kenya National Archives, Provincial Commissioner/GRSSA/2/20/22, Ref: PW.8/4/139. 26th January 1961.

429 Kisaka C. (1970). Rhamu Water Supply, Kenya National Archives. PC/GRSSA/3/23/16. Ref: DCM.8/7/292, 4th August 1970.

district. By 1969, Fino Division had five pans, two at Bata while Fino, Harese hosle, and Hidan Golja had one each.

In 1970, Elwak/Takaba Division had twelve pans each at a distinct location. Rhamu division had seven pans. No water pans had been silted for three years, Mutunga, acting District commissioner, recommended silting before the rains had started⁴³⁰.

Construction of treatment works started in 1982/83. However, the financial year suffered various delays, particularly withdrawal of funds in mid-March 1983. The construction then started in earnest in October 1983 and consisted of, one unit of composite filtration unit of 25 cubic metres per hour with a backwash 4.5 m³ and one clear water tank of 90 cubic metres⁴³¹.

Treated water expected to be pumped to distribution reservoirs once the project completed. The provincial water engineer, Muhamud, observed that the existing reservoir was inadequate in terms of both available head and capacity. This made it imperative for an additional 90 m³ reservoir on an 18-metre tower at Bulla Mpya, which was on a higher point than the existing reservoir.

Mandera urban water supply was completed in 1956. It covered an area of 64-kilometre square and produced 350 cubic metres of water per day. The pipeline was ten kilometres long with a three-inch diameter. The supply had a diesel engine and a pump, a staff house and dosing equipment⁴³².

Some of that money was meant for electrification of the Mandera water supply during the 1983/84 financial year. An attempt for electrification of the supply made in 1980 never succeeded. The electrical inspector was expected to collect the necessary data and put up the required application to Kenya Power and Lighting Company for the supply of electricity⁴³³.

The ministry of works made a proposal to construct a 90m³ steel water tank on a 10M steel tower for the current and future needs of the Mandera district hospital. Chief electrical engineer requested for cost estimate of material and labour that was needed to connect water pipe to the tank from the source of water⁴³⁴.

430 Kisaka C (1970). Rhamu Water Supply, Kenya National Archives. PC/GRSSSA/3/23/16. Ref: DCM.8/7/292, 4th August 1970.

431 Mahamud M.M (1983). Mandera Water Supply Electrification, Kenya National Archives. SL/1/3, Ref: WS/15/VOL.1/ (88), 1st September 1983.

432 Davies A (1957). Mandera Water Supply. Kenya National Archives, PC/GRSSA/2/20/22, Ref: WAT.88/9/34/102, 23rd March 1957.

433 Mahamud M.M (1983). Mandera Water Supply Electrification, Kenya National Archives. SL/1/3, Ref: WS/15/VOL.1/ (88), 1st September 1983.

434 Young G (1981). Mandera District Hospital Extensions Water Supplies, Kenya National Archives. SL/1/3, Ref: EM. D11. NE732/954G, 20th November 1981.

Construction of composite filtration unit: In November 1981, the construction of composite filtration tank and clear water sump at Mandera W/S was in progress. Mr Otieno, the inspector in charge of the water development project, conducted the deployment of the casual employees and transport available in the district. The district water officer was the overall in charge of the construction gang liaising with the inspector. Mr Ng'ara recommended maximum utilisation of the workmen since funds available was not adequate, the number of casual labourers were restricted to 25 men only. The men were also used on any emergency like scooping out sand from wells during long droughts and in any other problem that arose⁴³⁵.

Enumerated hereunder are the proposed works in 1980⁴³⁶:

- 1) Digging more wells and installation of collection pipes to the wells;
- 2) Use of shuttering after digging trenches;
- 3) Construction of two units of composite filtration, each measuring 25 cubic metres per hour with backwash of each 4.5 m³;and
- 4) Construction of two boreholes in the township.

Generally water situation in Mandera was better than in Moyale. There were two dams, three major pans and a number of wells at El Wak besides Daua River. The wells were preserved and maintained by a committee of ten prominent personalities residing in the neighbourhood. Cleanliness in and within the precincts of the wells was highly maintained.

After the independence, water development works continued but this time with an African administrator. The development partners sometimes funded the works. A particular case is the funding of the Rhamu water supply from Swedish loan, which imposed special accounting responsibilities. The development progressed reasonably and by 1983, electrification of the water supplies was in progress.

Mandera water provision faced multiple challenges which included:

- Sometimes disharmony arose between the administration and other shareholder departments. An instance of Conflicting reports between the PC and the Hydraulic Engineer about the water situation in 1953. The PC argued it was inadequate while the engineer indicated the otherwise.

435 Ng'ara F. J (1981). Construction of Mandera Composite Filtration Unit, Kenya National Archives. SL/1/3, Ref: WS/15/VOL.11/ (53), 18th November 1981.

436 Makondilege S.C (1980). Mandera water Supply, Kenya National Archives. SL/1/3, Ref: /3/3/203/ (44).

- The paradox that, Mandera required more water supplies, adequate water supplies caused political problems, which consequently caused grazing problems.
- Africans were not permitted to erect pumps on Eil Wak wells; this hampered further development by other departments as they too could not be permitted.
- The rate of corrosion due to salinity of water was quite high; this considerably increased the cost of maintenance and discouraged installation of both the piping and metres.
- Africans' camels were used for fetching water against their (Africans) will; the camels were overworked and not well grazed.
- Well maintenance and repair was done communally sometimes compulsorily, and able-bodied males were expected to perform reasonable services whenever required.
- This was a sheer exploitation and abuse of African labour and resulted into problems such as, shoddily done work, disuse and misuse due to ownership problem.

3.3.2.5 Eastern Province Water Supplies

Moyale Water Supply: Moyale district is situated almost at the Kenya/ Ethiopian border. According to Resident Engineer, Moyale was smaller than other districts but had equally acute water supply problems as other districts in the northern frontier. Migration of stock to and from Abyssinia depended on both the rainfall and the activities of trans-frontier tax gatherers. To the west of Moyale tribesmen watered their stock from a total of 55 or more wells in Abyssinia. Most of these wells were good and could water about 400 cattle per day. Water on such scale was not available in the district⁴³⁷.

The total consumption of water in Moyale district in 1935 was about 3.2 m³ per day. The District Commissioner started the development works in the same year. He wrote to the officer in charge Northern Frontier Province expressing concern over yearly loss of water from corrugated iron roofs without catchment tanks in the boma. He felt that if all the surplus rainwater was used economically, the boma could remain independent of the well water. The rainfall provided adequate amount⁴³⁸.

The total amount of rainwater from different catchment areas was 541 m³ per annum. The police lines collected most with about 170 m³ per annum. The district commissioner's house was second with about 91 cubic metres. The new police lines, Medical Officer's house, clerk's house, isolation ward and the boy (police) lines made

437 Resident Engineer (1953), Northern Province and Samburu District Water Supply (Dixey Scheme). Kenya National Archives, BB.7/29.10th March 1953.

438 District Commissioner Moyale (1935) Moyale Water Supply. Kenya National Archives, BB.7/29, Ref: P.W 8/2/1/355. 14th August 1935.

the rest catchments. The District Commissioner advised re-erection of the tanks available at suitable catchment areas. Because of the high cost of transportation the tanks were to be dismantled, transported and then re-assembled. Another method to effect catchment was to dig suitable pits surfaced with cement and water proofing materials⁴³⁹.

Eil Wak Wells: The Moyale district commissioner carried out investigations into Eil Wak wells in 1936. The investigations of the twenty wells found out that an average of twelve to eighteen men drew water in each of fifteen wells. Among them, one well had grown trees, one was seasonal and another had stopped producing water in 1932⁴⁴⁰.

Geologist James Scott and Captain Hughes, East Africa Engineers, re-examined the wells at Eil Wak in March. They found that; almost all wells had gypsum all the way down and water was highly mineralized, accidents occurred occasionally when operators fell into the well and all the wells were hand operated and the positions of the operators were badly sited. They recommended digging of steps and warned against use of pumps because the area was remote and people knew nothing more than lifting water by hands⁴⁴¹

Buna Borehole: This was the most successfully used borehole in 1940. However, in 1945, it was filled with stones. The District Commissioner recommended it ideal for experimentation purposes. Buna borehole had a depth of 19 metres and yielded 2.3 m³ per hour. The borehole had been put up for the army in 1945. The experiment was expected to provide valuable experience and information on the operation and control of boreholes in the northern frontier district.

Buna borehole was recommended in the Dixey Report. Mr. Tatton Brown's five-year plan classed it as the most important in the Moyale District. Implementing the plan would assist natives dig water pans. In October 1946, the Chief Engineer, East Africa confirmed that booby trap was placed in the borehole and was partly filled with stones. No records existed to confirm the presence of booby trap at the well. The Director of E.A Drilling Co. Ltd, Craelius, recommended sinking a fresh borehole⁴⁴².

439 District Commissioner Moyale (1935) Moyale water supply. Kenya National Archives, BB.7/29, Ref: P.W 8/2/1/355. 14th August 1935.

440 James S (1940). Report On Wells, at Eil Wak N.F.D, Kenya National Archives, BB.7/29. March 1940.

441 James S (1940). Report On Wells, at Eil Wak N.F.D, Kenya National Archives, BB.7/29. March 1940.

442 Director, Craelius E.A Drilling Company limited Nairobi (1946). Buna Borehole. Kenya National Archives, BB.7/29. 2nd October 1946.

Pans and Dams: Alati pan was 37 kilometres south of Buna. The pan belonged to the Ajuran and Degodia tribes and was dug out every year. To avert conflict over the ownership between the two tribes, the District Commissioner recommended an alternating system of digging. During good rains Alati pan was usually full and supplied adequate water to the two tribes⁴⁴³

Mr. Reece expressed the need to make each tribe conscious of ownership of certain water and grazing supplies. This was meant make them proud and look after the supplies properly. It was therefore important that young men of the tribe, in whose grazing area was situated, did the work. The idea of forced labour was dismissed due to the lack of sufficient police guard and a strong boma. It was also felt that as in comparison to Abyssinia, where there was no forced labour, young men concerned would simply walk away⁴⁴⁴.

Water Tanks: Pan digging was purely a communal affair. In July 1947, The District commissioners, Moyale, Mandera and Marsabit, discussed pan digging in the Northern Frontier District. Against his counterparts, the Moyale DC felt that pan digging in the district was a waste of time and resources. This was due to the fact that, the tribesmen had to be forced to produce young men to work and when they did the numbers were not enough, the work was slack and elders made no effort to supervise it, the tribesmen made no effort to remove the silt that accumulated in the pans after the rains⁴⁴⁵. The DC recommended construction of very large tanks maintained by machinery.

The DC was opposed to the 300pounds spent on uneconomical pans. He claimed that they were only meant to show the tribes that the government was doing something for them. He argued that a minimum of only 100 pounds should be spent. Dam construction and wells maintenance were included in the draft estimates for the year 1948; however, conspicuously excluded were pan-digging estimates.

The Dixey Scheme: After investigations into water requirements in the Northern Frontier Province, Doctor Dixey recommended improvements of water supplies in Moyale District. He prioritized some areas. Moyale was scheduled to receive ten boreholes under the scheme.

443 District Commissioner, Moyale (1945). Alati Pan. Kenya National Archives, BB.7/29, Ref: PW/8/4/567. 16th June 1945.

444 District Commissioner, Moyale (1945). Alati Pan. Kenya National Archives, BB.7/29, Ref: PW/8/4/567. 16th June 1945.

445 District Commissioner, Moyale (1947). Pan Digging. Kenya National Archives, BB.7/29, Ref: PW/8/4. 4th July 1947.

Each borehole was expected to support about 1,000 head of cattle per day, an estimated 18.2 m³ per day. Titu and Balobleh areas were given the top privilege for both boreholes and tanks construction. This was because it could open up an extensive area of grazing to the British Boran. The district commissioner expressed the need to embark on the works for the two tribes simultaneously and the work continued in a rotational basis⁴⁴⁶.

The main objective of water development plan (1950) was to lay down a logical plan for the development of the water resources in Moyale District. This was because:

All tribal life in Moyale District entirely depended on water. The Boran, Ajuran and Sakuye were all semi nomadic herdsmen depending on stock for their livelihood.

Successful administration of the tribal life of the District depended upon and was related to the following water issues:

- The provision and control of adequate water facilities
- The control of as far as possible of grazing habits
- The maintenance of peace between tribes by means of segregation
- The collection of tax
- The maintenance of discipline with various tribes.

In the absence of permanent or adequate water in Moyale District, all the Boran and a large number of Ajuran moved across the border to Ethiopia to the large permanent waters around 'Ley'. Others actually moved and settled in Ethiopia⁴⁴⁷.

The Development plan estimated construction of 17 dams by 1951 and approximately 30 temporary pans completed in 1952. The plan for 1952 was meant to increase the temporary water facilities in the wet weather grazing areas by the construction of seasonal pans. The pans were expected to increase the time cattle spent in wet weather grazing areas⁴⁴⁸.

In 1953, the Resident Engineer, Nanyuki reported on permanent supplies in the Ajuran and Sakuye areas that were fairly supplied with permanent water supplies. There were: four Dobel, and three Aleri wells, the Buna Wells, the Ajao well, the Gurra wells. In the boma area there were the Holali wells and the Lemu Heilu wells. There were good tank sites existing. The Boran area was badly off. Only Sololo well

446 District Commissioner, Moyale (1949). Dixey Scheme. Kenya National Archives, Ref: LND.16/5. 23rd February 1949.

447 District Commissioner, Moyale (1950). Moyale Water Development Scheme. Kenya National Archives, BB.7/29, Ref: PW.8/4. 29th November 1950.

448 District Commissioner, Moyale (1951). Water Development Plan. Kenya National Archives, BB.7/29, Ref: P W.8/4. 13th January 1951.

was capable of producing about 2.3 m³ per day. It was impossible to meet the daily requirements of the stock from the available wells⁴⁴⁹.

A considerable amount of work had been done by 1953 to provide temporary supplies in the form of dams and tanks. Though some were not successful, six of them provided water for two to three months after the rains. There were also several natural pans; the biggest were at Guna, and Uncil. Water was also available in (dololos) natural depressions in the riverbeds such as Mudama and Mamal. This lasted for two to four months after the floods. There were several temporary shallow wells where small quantities of water collected after the rains and water obtained for varying periods. The wells were usually situated at the bases of the hills very close to the rock. The run-off percolated into the sand, and was held up by the sandy clays below. Practically every hill had several wells⁴⁵⁰.

Recommendations: The Resident Engineer, Messrs. Howard Humphrey and Sons recommended the following for improvement of both permanent and temporary supplies:

1. Construction of tanks at Kubi Sarar, and Sarar to hold 4546 m³ each.
2. Provision of permanent water supply for the Boran and Sakuye areas by boreholes.
3. Digging several wells at south of Hoga to Kurkura and westwards for the very good existing grazing areas.
4. Upgrading the three existing tanks and pans as a part of surface supplies improvement.
5. Widening the natural depressions in the riverbeds.
6. Tanks construction in twenty areas.
7. Fitting the government well with proper top and hand pump to save time.
8. The debris was recommended for investigation. Further investigations were recommended.
9. Surface Water Supplies excavation.

The Executive Engineer, Classen, visited Moyale district and examined a number of rock catchments in February 1960. He made the following observations and recommendations⁴⁵¹:

449 Resident Engineer (1953). Northern Province and Samburu District Water Supply (Dixey Scheme). Kenya National Archives, BB.7/29.10th March 1953.

450 District Commissioner, Moyale (1951). Water Development Plan. Kenya National Archives, BB.7/29, Ref: P W.8/4. 13th January 1951.

451 Classen G.A (1960). Moyale District – Surface Water Supplies. Kenya National Archives, BB.7/29. 29th March 1960.

Tarbi, a considerable area of bare rock finishing up with a deep pocket at ground level could yield more water if a wall was built across the natural mouth to a height of two metres.

Rapsul, Ambalo hills, a partially constructed rock catchment with a very efficient small tank holding about 22.7 m³ fed by extremely well built garlands had potential for more water.

Hara Gotu was a concrete dam build in the valley below the Moyale boma to the west of the main road. Further developments were possible in this dam.

Lensayu Rocks in the South-West Korondil could permit comparatively cheap development. The capacity could be improved by building a good wall. The Engineer advised addition of garlands, building of small bridges across cracks in the rock, which would form aqueducts connecting the garlands to the storage.

Growing Demand and Maintenance Works: It was locally believed that the government supply in Moyale township wells was steadily decreasing. According to Kennaway the government supply involved drawing water from an open well and carrying by lorry or donkeys to lines and staff housing⁴⁵². There was no township supply system and individual plot owners drew water using their own debes and donkeys. The hospital costs were small since it had four labourers with six donkeys and barramils to fetch its water⁴⁵³.

The rapid growth of the boma and the township and other increasing commitments such as the large new school, contributed to extra stress on the existing water supply. Security and health were the main emphasis of an improved supply. The Moyale District Commissioner expressed the need for installation of a borehole with full reticulation. Overall the tribesmen, the Moyale boma and township required an installation of permanent water supplies⁴⁵⁴.

While wells were considerably affected by variations in the rainfall, frequent maintenance was necessary. The existing government supply system was both inadequate and expensive. It consumed approximately 1,800pounds a year. It was difficult to improve the wells, which had been developed by the Boran over several hundred years, in the vicinity of Moyale Township.

This was attributed to the unknown depth of rocks, availability of the machinery for carrying out the work and the cost of transport and maintenance.

452 Kennaway N. F (1957), Township Water Supply-Moyale. Kenya National Archives, BB.7/29. 18th Feb 1957).

453 Eggins E.C (1958). Boreholes & Township Water Supply. Kenya National Archives, BB.7/29, Ref: PW.8/4/5/118. 3rd June 1958.

454 District Commissioner, Moyale (1959). Dixey Scheme. Kenya National Archives, BB.7/29, Ref: PW.8/2/3/219. 30th April 1959.

An investigation into the recharge area six kilometres from Moyale to southeast established that ground water was present over most of the western half of the transverse. It was recommended that a borehole of 107 metres depth be drilled. At this site quantity of uncertain quality was guaranteed. The dam site, a kilometre and half west of Moyale Township was recommended for further exploitation in future. To this end an approximate cost of 1,000 pounds for drilling and testing with an additional 2,000 pounds for the mechanical installation and storage was made⁴⁵⁵.

Improvement works: The problem of Moyale water supply at the Moyale Boma was put before the Water Resources Authority in July 1959. It was given an 'A' priority for investigation, during the year 1959/60. The investigation was meant to establish the possibility of providing a non-gazetted water supply and the divisional engineer was given the due investigation assignment⁴⁵⁶.

The Divisional Engineer investigations gave two proposals:

- 1) The supply serving government officials only the costs would be 2,560 pounds per annum with revenue of 560 pounds expected. A recurrent loss 2,000 pounds, which compared to existing loss of 2,400 pounds per annum.
- 2) A fully public water supply where water rate of at least 8 to 10 shillings and above per 4.5m³ was chargeable.

The Water Resources Authority was expected to prioritize the supply for government servants, which was subject to KES 11200 per annum revenue collection. The two proposals were considered, a supply to the government institution of an estimated demand of 29.5m³ per day and a full public water supply for the township at an estimated demand of 84m³ per day. The estimated cost of the smaller (institutional) type of supply was, KES 311,000 while that of full public supply was KES 536,000. The revenue was based on 6 shillings per 4.5m³ for the public supply as shown in Table 3.23⁴⁵⁷.

455 District Commissioner, Moyale (1959). Dixey Scheme. Kenya National Archives, BB.7/29, Ref: PW.8/2/3/219. 30th April 1959.

456 Chief Hydraulic Engineer (1960). Moyale, Proposed Moyale Water Supply. Kenya National Archives, BB.7/29, Ref: 12th December 1960.

457 Chief Hydraulic Engineer (1960). Moyale, Proposed Moyale Water Supply. Kenya National Archives, BB.7/29, Ref: 12th December 1960.

Table 3.23: Estimated revenue for the public supply

Type of supply	Cost (pounds)				Revenue
	Capital charges	Direct operation	Hidden overheads	Total expenditure per annum	
Institutional	466.5	1,160	300	1,926.5	266.5
Public	804	2,450	500	3,754	1,710

The Chief Engineer recommended public water supply to be given the first priority for final investigation and design in 1960/61 and be listed for 1961/62 estimates. He proposed water tariffs at 7.50 shillings per 4.5m³ or public be built to supply water at the cost of 0.5 shillings per debe.

The Chief hydraulic Engineer ordered some pumping test of wells at Moyale and results were ready in mid-March. The Engineer then issued the report to the Water Resources Authority On 24th April 1960.

The Water Resources Authority allocated an 'A' priority to Moyale. However due to inadequate funds in 1960/63 the works took second place to the augmentation of existing water supplies.

Meanwhile the Ministry of Agriculture was making a bid to the Development Committee on December 1960 for a supplementary estimate of 200,000pounds for the period 1960/63 for water development⁴⁵⁸.

By 1962 the existing water supply continued to be dirty, irregular, primitive and precarious, just as it had been before⁴⁵⁹. Moyale, being in the northern frontier province, had general geo-physical challenges like any other district in the region, the following problems were encountered:

- Long term planning and administration problems: Africans in the district were nomadic pastoralists always on the move, to the Abyssinia and back to Moyale. This brought about uncertainty in water development planning.
- Well construction and maintenance was an expensive and dangerous exercise. In some instance seepage from depression round the wellhead used as troughs caused rottenness of limestone. This caused rock falls, killing persons working beneath.

Due to the high temperatures and geological composition, water was not retained in the pans. Indeed, pan digging was a waste of time and resources.

⁴⁵⁸ Chief Hydraulic Engineer (1960). Moyale, Proposed Moyale Water Supply. Kenya National Archives, BB.7/29, Ref: 12th December 1960.

⁴⁵⁹ District Commissioner, Moyale (1962). Water Development Scheme-Moyale. Kenya National Archives, BB.7/29, Ref: PW.8/2/3/263. 10th February 1962.

Marsabit Water Supply: Marsabit, a rural centre and district headquarters for Marsabit District in Eastern Province by 1983, was located on Addis Ababa Highway 540Km North-Northeast of Nairobi. Marsabit Mountain contained a large forest area which was a national park. Further down the mountain, the area was used primarily for livestock. The annual rainfall in the area ranged from 200mm on the outer fringes of the area to 900mm on the higher forested zone of the mountain. Temperatures varied from 13⁰ Celsius to 26⁰ Celsius and the altitude was 1370 m and 1060m above sea level.

Marsabit district was an important administrative unit with an area of 67340 square kilometres. A case in point is that most of Marsabit waters came from the mountain around the Marsabit forest⁴⁶⁰. Rainfall in Marsabit improved with years though not with consistency. In the period between 1919 and 1922, the average annual rainfall was 528mm. In the period between 1935 and 1941, the average annual rainfall was 927 mm. The highest rainfall year recorded was 1941 and continued up to 1942.

The Marsabit Boma: In 1933, the only source of water supply to the station was Delamere's Njoro. It was subject to constant pollution. Under the advice of the Medical officer of health, the provincial commissioner recommended the following to improve the boma water supplies⁴⁶¹:

- Construction of a well fence surrounding the Delamere's Njoro spring to eliminate the possibility of drainage onto the reservoir.
- A wall trench put up to protect the spring and the reservoir from surface washings.
- Clearing of weeds, scum etc. and repair to the reservoir wall to protect and conserve the yield of the reservoir.
- Fixing of pipes at a position to allow receptacles be filled. The overflows to be directed into cement troughs and finally disposed out for channels
- In January 1934, almost all the work had been done and two thirds of the excavation was completed. Mr Low, the Marsabit District commissioner was in charge of the work⁴⁶².

Hurri Hills were the most important source of water in the district by 1935. It was the source of water to the native areas. However, rock formation disallowed any

460 Member for the Agriculture and Natural Resources (1950). Kenya National Archives PC/EST/2/7/3, Ref: WAT.36/9/35/38, 12th September 1950.

461 Glenday V. G (1933) Water Supplies-Marsabit District, Kenya National Archives, PC/EST/2/7/3, Ref: PW/8/4/4/942, 1st September 1933.

462 Blake G. A (1934) Marsabit Water Supply, Kenya National Archives PC/EST/2/7/3, 24th February 1934.

meaningful improvement that led to scarcity. The springs near the Hurri Hills could be enlarged and more discovered to make the good grazing areas in the hills useful during the dry weather.

Grazing in the forest was discouraged to protect the tree seedlings from damage. The DC advocated for the use of the sufficient grazing areas without the necessity of using the areas in close proximity to the forest. The political situation in the north-west of Marsabit was volatile in 1937 and the DC felt that the area should not be improved until the situation calmed down. The Gabbra tribe inhabited this area⁴⁶³.

Water in Marsabit was a perennial difficulty and during the dry season water was carted using the ox-wagons and backs of mules. The exercise was primitive and time wasting and not cost effective. Rationing was proposed⁴⁶⁴.

The quantity of water in Marsabit was declining and in 1942, Engineer Geologist Tetley reported a major fall in the yield of both the Sokorte Dika spring and Delamere's spring to about 9 m³ or less per day⁴⁶⁵. The Delamere's Njoro, the only supply to township was gradually running dry. At the same time, water in the Marsabit Mountain was disappearing onto the desert below. Several other centres, which contained water, were rapidly drying up. This happened regardless of the exceptionally good rains; as a result, the little available water was rationed and guarded day and night by police⁴⁶⁶.

Boma supply improvement: The District Commissioner and the Provincial Commissioner agreed on the need to adopt a proposal for developing one of the well started by the South African troops for the boma supply. At the time, materials for water supplies were urgently required for military purposes. By September 1942 the population of the government station was 580 (including ten Europeans) all of whom were dependent on the Delamere's Njoro supply, which produced about 2 m³ per day. The water was hardly enough for the DC family and the townspeople. The DC felt nothing else could improve the water situation apart from piping⁴⁶⁷.

463 DC, Marsabit (1937) Water supplies –Northern Frontier, Kenya National Archives PC/EST/2/7/3, Ref: GR.91/vi/37, 20th April 1937.

464 Thorp J. K. R (1943). Marsabit Water Supply-Maintenance, Kenya National Archives PC/EST/2/7/3, Ref: P.W.8/4/210, 9th March 1943.

465 Tetley A. R (1942). Marsabit Water Supply, Kenya National Archives, PC/EST/2/7/3, Ref: P.W./8/4/796.

466 Reece G (1942) Telegraph to the Hon. Chief Secretary, Kenya National Archives PC/EST/2/7/3, Ref: P.W.8/4/4, 9th August 1942.

467 Reece G (1942) Telegraph to the Hon. Chief Secretary, Kenya National Archives PC/EST/2/7/3, Ref: P.W.8/4/4, 9th August 1942.

By May 1943, the proposed scheme had been completed. The Asian overseer commended the, Sarwan Singh, and Charan Sigh, for the speed and efficiency with which the work was carried out⁴⁶⁸.

Boreholes were spread in most parts of Marsabit and in the following localities, Dukana, Hurri Hills, North of Hurri Hills Maikona, Marsabit Mountain, Lug Logo, Laisamis and Merille. Maikona and Lug Logo had cement seal broken and stones had filled them within a few metres of the surface and they had been left open. After visiting these boreholes the DC concluded that only Laisamis and Merille were revivable in a short notice⁴⁶⁹.

In August 1951, the works supervisor, Mr. Porter visited Marsabit district to examine⁴⁷⁰: New sites for wells, excavated pans and rock catchments for the storage of water in isolated districts, details of each site.

The following was established:

- Kalantina was 8 metres deep well, located at the Marsabit Mountain and was fitted with semi-rotary hand pump. It was in operation.
- Delamere's Njoro was at the same location and was used mostly by the Africans.
- Lugga Adama was located beyond the limit of Marsabit airstrip. It was a dam intended for temporary watering of stock only.
- Lugga Gombo was a steep gorge some kilometres across Marsabit Mountain. It was badly polluted by flocks of small birds and baboon, and was not used for some time.
- The Hurri hills were extensive range of hills just south of Ethiopian border. They provided some finest grazing in the Northern Frontier.

Seven more other catchment sites were examined and recommendations made thereof.

Generally the Engineer-Surveyor recommended that further works should not be carried because of precarious political reasons.

Any pilot scheme should be undertaken in large-scale, large enough to warrant installation of a police guard. The guard would protect them from the Ethiopian raiders.

468 Thorp J. K. R (1943). Marsabit Water Supply-Maintenance, Kenya National Archives PC/EST2/7/3, Ref: P.W.8/4/210, 9th March 1943

469 District Commissioner, Marsabit (1944), Boreholes, Kenya National Archives PC/EST2/7/3, Ref: SEC.3/10, 1st August 1944.

470 Engineer-Surveyor (1951). Report on Water Survey, Marsabit District, Kenya National Archives PC/EST2/7/3, Ref: LAS/70/315, 30th August 1951.

The best method of construction and recommendations on how to go about it were made for each site.

Water charges: Water charges for metered connections were 4 shillings per 4.5m³ within a minimum charge of 13 shillings a month. The Kiosk charge was 4 cents per 18 litres (10 shillings per 4.5m³). The average domestic consumption per household was 22.7m³ per month. The DC, Marsabit wanted the water rates to be kept at the means of average people's ability so that the boma and morale of its inhabitants could improve. He consequently, proposed a reduction in water rate from 4 to 2.50 shillings per 4.5m³ with a minimum charge of 13shillings a month⁴⁷¹.

Cusack, the Provincial Commissioner Northern Frontier Province, echoed the sentiments of the Marsabit District Commissioner. That it was in the interest of health, happiness, welfare and morale that government staffs got special treatment and were precluded from works of cleaning and maintaining their quarters. He proposed that a flat rate of ten shillings a month per household per month was fair⁴⁷².

Songa Gambela Scheme: The scheme was put forward for watering cattle and therefore put the large grazing areas on the side of Marsabit Mountain into use. It was estimated to accommodate 6,000 heads of cattle consuming 20,000 gallons of water per day. The total cost of the scheme was estimated at 5,000 pounds. Construction of a watering trough about half a mile outside the forest down the Lugga was envisaged. The total length of the watercourse in the Lugga from source to the base pool at the forest edge was 4,833 feet and the width of the Lugga at its narrowest point was about 15 feet, which was the proposed area source. The scheme envisaged piping water through gravitation into reservoir tanks holding 40,000 gallons⁴⁷³.

The township received water from various springs and wells (Bakuli springs, Ulanula wells, Sagante wells) and other minor boreholes and wells situated within the forest zone. The total capacity of all these was about 220m³ per day. The MoWD supplied water through a small pipe distribution system⁴⁷⁴.

The township water supplies depended on the transportation of water from boreholes, wells, and river-beds by tanker or lorry. In Marsabit where progressive deterioration of the existing supplies had led to the application of strictly water rationing to all township residents, a township water scheme was started. By the year end intake and purification works were under construction. Also 3.6 kms of

471 District Commissioner, Marsabit (1953). Marsabit Water Supply-Charges, Kenya National Archives PC/EST2/7/3, Ref: PW.8/8/vol.11/265, 17th September 1953.

472 Cusack J (1953). Letter to the Deputy Director of Public Works, Kenya National Archives PC/EST2/7/3, Ref: PW.8/4/4/220, 25th September 1953.

473 District Commissioner (1954). Songa Gambela Scheme, Kenya National Archives PC/EST2/7/3, Ref: PW.8/4/4,3rd February 1954.

474 Hunn G (1983). Progress Report About water Projects included in the Minor Urban Water Supply Programme. NORAD –Coordinator/MOWD. Nairobi Ref: WD/1/2/5. 10th June 1983.

trenching had been dug for the accommodation of the main pipe line running from Muddo Bakuli to the Boma⁴⁷⁵. Meanwhile the work on the development of a piped water supply for Isiolo Township was commenced in September, and Mr. A H Randall was the one in charge of the operations until 15th December. Water continued to be distributed to quarters by water truck⁴⁷⁶.

The Marsabit Township Water Supply Scheme which was undertaken by the PWD in 1951 was completed in October 1952. Water mains were laid in all Government residential plots and the trading centre. Two water kiosk points were established and in use. One of the kiosks was located at the trading centre while the other one was located near the Delamere Njoro well for the use of the Karantina-Majengo areas⁴⁷⁷.

The East Africa Engineering Consultants Kenya were awarded design and supervision of the Marsabit water supply in November 1979. Table 3.24 analyses the population and water demand projections for Marsabit in 1980

Table 3.24: Population and water demand projections in Marsabit in 1980

Year	1980	1990	2000	2010
Urban population at a 6% growth rate	6000	10745	19245	34460
Rural population at 3.5% growth rate	9000	12695	17910	25260
Total	15000	23440	37155	59720
Water demand (m ³ per day)	3750	5860	9290	14930

The demand for livestock was 500m³ per day, based on 10000 units and 50 litres per day. However, the water supply was not supposed to cater for livestock. The population within the entire mountain division of 2090km² was 17268 according to 1979 census. The population within Marsabit location was of 999km² was 8739⁴⁷⁸.

Proposed scheme: The consultants indicated that the likely locations of the new sources were in the numerous river valleys which radiated out from the higher areas of the mountain on the eastern slopes. The total yield was estimated at 15000 m³ per day. The cost of phase one of the schemes was KES 52 million in February 1981 and

475 Provincial Commissioner (1951). Northern Frontier Province, Annual Report 1951. Kenya National Archives. PC/NFD/1/1/10, 1951.

476 District Commissioner (1951). Annual Report-Isiolo District for the Year 1951. Kenya National Archives. DC/ISO/1/1/2, 1951.

477 Provincial Commissioner (1952). Northern Frontier Province, Annual Report 1952. Kenya National Archives. PC/NFD/1/1/10, 1952.

478 Hunn G (1983). Progress Report About water Projects included in the Minor Urban Water Supply Programme. NORAD –Coordinator/MOWD. Nairobi Ref: WD/1/2/5. 10th June 1983.

involved development of new sources, improving the existing ones, augmentation of treatment sources construction of reservoirs and augmentation of water reticulation.

Mt. Marsabit forest was a unique but most fragile ecosystem within arid and semi-arid area in the northern part of Kenya. There was a danger in disturbing the ecosystem by many people settling on it. The size of the Marsabit water supply was therefore to be determined by the number of people and livestock the ecosystem of Mt Marsabit could sustain. The consultants indicated that if NORAD was interested in funding the Marsabit water supply, a wide master plan study was necessary. The consultants were of the view that the rural areas surrounding Marsabit should also be covered⁴⁷⁹.

Water Improvement Efforts: The first proposal came up as a result of perennial water shortage and particularly the acute shortage experienced in 1946. In January 1946, the Daua River almost dried up. The water level in the well diddled to 29 ft. The District Commissioner urgently needed a water pump to help improve the water situation. The Gailey Roberts, Hydraulic Department quoted (Table 3.25) the following for a Diesel pump capable of drawing 22.7m³ per day. It was supposed to pump water for 3.2km up 30.5 metres rise to the township and the boma⁴⁸⁰.

Table 3.25: Quotation for the diesel water pump

Component	Amount (KES)
Head	2,140
Cylinder	200
3-inch pipe	3.53 per ft.
2 and a half-inch pipe	3.14 per ft.

Second proposal: The second proposal in February 1947 was a power driven water supply system. A supply installed and connected to both the boma and township piping was envisaged. It was also expected to serve the whole community through three or four distribution points as shown in Table 3.26.

479 Hunn G (1983). Progress Report About water Projects included in the Minor Urban Water Supply Programme. NORAD –Coordinator/MOWD. Nairobi Ref: WD/1/2/5. 10th June 1983.

480 District Commissioner Mandera (1946). Water Supply- Mandera. Kenya National Archives, PC/GRSSA/2/20/22, Ref: PW.8/4/1/188, 24th January 1946.

Table 3.26: Quotation for supply, transport and installation of water pump

Materials	2,28 (4pounds)
Installation	500
Transport	500
Total	5,284

The District Commissioner expected the scheme to pay back in ten years' time. This was possible in assumption that the average cost of water for government servants was 300pounds. The rates of 10/- for residential plot and 20/- for trading plot were proposed. The returns were expected to rise as more people took up plots and started water consumption⁴⁸¹.

When His Excellency visited Mandera in February 1947, he gave orders to start water schemes fastest possible. He found the existing water supply method most undesirable. He was apprehensive that, tribesmen camels were hired against their will and worked hard without grazing. He was concerned of the substantial expense involved. Consequently, the provincial commissioner made an application to the Ministry of Agriculture for the 250pounds to improve the supply to the government staff⁴⁸².

Meru Water Supply: During the 1920s, the public work department played a major role in enhancing reliable water supply to the inhabitants of different localities in Kenya. For example, in 1927, Meru Township, the Public Works Department was responsible for making a furrow which led water from the Uaso Nyiro River into furrow which had been made from Morania River. To do the work, tribal labour under the Native Authority Ordinances was used⁴⁸³.

By 1935, the Pig and Whistle Hotel and Garage in Meru had its water supply scheme all worked out and what remained was application for water right. The owner was not interested in a communal water supply. In 1936, Mr Lane, Senior Assistant engineer in charge of Public Works Department, Nyeri sought information regarding the feasibility of a water supply to the Meru Township in general. He wanted to know whether there was any demand for a water supply to the business area of the township, government buildings, and in other officials' houses and hotels. He

481 District Commissioner, Mandera (1947). Mandera Water Supply. Kenya National Archives, PC/GRSSA/2/20/22. Ref: PW.8/4, 24th February 1947.

482 Pinney J (1947). Mandera Water Supply. Kenya National Archives, PC/GRSSA/2/20/22, Ref:8/4/9/27, 23rd September 1947.

483 Acting District Commissioner (1927). Meru District Annual Report for the Year Ending 31st, December 1926. Kenya National Archives. DC/MRU/1/1/2, Ref 28/3/27, 17th, March 1927.

projected that were a supply installed in the same lines as in Nyeri, a charge of about 3 shillings per 4.5 m³ and a minimum charge of 10 shillings would be levied. It was apparent that due to presence of Kazita River in the vicinity of the business area, the local merchants could not support any water supply scheme⁴⁸⁴.

The DC, Mr Jennings, confirmed that there was no demand for water supply to the business area. The government buildings had three connections while the hotel proprietor wished to install his own ram. The DC's house, the medical officer's house and two other government buildings required water connections⁴⁸⁵.

Meru Hospital: The rate of flow of the spring near the hospital was measured in January 1936 and recorded 3.1 m³ per minute. Installation of water supply to the hospital largely depended on maintained river flow that could drive a ram. Although there was little demand investigation for the township supply was at this time underway from Kazita River, Mr. Lane proposed a gravitational supply. However the government considered favourably the installation of a ram, delivery pipe, service tank, and piping to the rather scattered bungalows. This would release an average of thirty prisoners' uneconomic work. The supply required an estimated approximately KES 6000. A piped supply from the spring to serve the native hospital was constructed the same year. The hospital water cost was approximate KES 4000⁴⁸⁶.

The population in Meru Township constituted 25 Europeans, 148 Asiatics, and 627 Africans by 1937. McKeag estimated daily consumption as, each European 455 litres, each Asiatic 141 litres and each African 45 litres per day. This made it a total of 57311 litres per day⁴⁸⁷.

Existing water supplies: By 1937, there were no water laid on at Meru and thirty prisoners were employed daily in carting water with buckets. This happened regardless of simple gravitation methods of bringing water to the township. Meru Township was amply supplied by numerous furrows, which owing to the topography of the station suited any point at which a water supply was necessary⁴⁸⁸.

The township furrow water was used for irrigation, watering stock and washing clothes largely by natives and Asiatics. No one, native or none native used it for drinking purposes. The furrow throughout its length was entirely protected from pollution. Despite this, water in it was full of mud and other foreign matters in

484 Lane H. W (1936). Water Supply Meru. Kenya National Archives, DC/MERU/2/15/11, Ref: 220/7/2/10/1, 7th February 1936.

485 Jennings F. G (1936). Water Supply-Meru Township. Kenya National Archives, DC/MERU/2/15/11, Ref: PW.8/4/7/150, 21st February 1936.

486 Lane H.W (1936). Water Supply-Meru Hospital. Kenya National Archives, DC/MERU/2/15/11, Ref: 318/7/2/10/1, 25th February 1936.

487 McKeag V.M (1937). Statement of Population and its Distribution. Kenya National Archives. DC/MERU/2/15/11, Ref: PW.8/4/7/1447, 2nd November 1937.

488 Walmsley C.H (1937). Tour of His Excellency in Central Province. Kenya National Archives, DC/MERU/2/15/11 Ref: D.357/117/2/27/1, 5th August 1937.

suspension and was not suitable for domestic purposes. The thirty prisoners carried water to the houses of eight European officials with 44 people, 4 Asiatic officials with 18 people and to the prison with 100 people. That is 172 people had no other source of water supply for domestic use apart from inadequate supply of rainwater. The prisoners were paid at 25 cents per day (7.50 shillings per month) for the services. This appeared a very excessive labour especially as Meru had an excellent well-distributed rainfall and houses were equipped with gutters and rainwater tanks⁴⁸⁹.

The springs were carefully enclosed to protect them from pollution and were reputed to have a recorded flow of 3.1 m³ per hour, which was an ample supply for the township. Mr Walmsley, the acting director of public works, felt that if a scheme to supply 68 m³ per deim was designed, it could not even sell a quarter. Welmsley confirmed that there was no demand for a water supply to the business premises and the trading centre. He concluded that such scheme would only cover European houses and the native lines that already had adequate supply by furrows. He therefore proposed that no justification existed for the proposed scheme to go on while other townships like in Nanyuki had a greater claim for consideration. The spring supply on analysis had proved to be of excellent quality⁴⁹⁰.

The Meru Indian Merchants Association was willing to welcome the water supply under condition that they paid a flat rate of 5 shillings per month. Approximately 25 Indians wished to join the water supply⁴⁹¹.

McKeag, the DC, gave two alternatives opposed the director of public works earlier observations that the township needed no water providing two proposals of water provision. The first scheme comprised of a supply to the government houses and lines by a ram and gravity from the spring source at the cost of 300pounds. The second involved supplying the whole township by gravity from Kaviva River at a cost of 1200pounds. If the first scheme was adopted the DC estimated a flat rate charge of about 7 shillings per month for Europeans and 3shillings per month for the Asiatics. If the second scheme was implemented and charged at a flat rate of 5shillings per month, it could provide revenue of 120pounds per year. He proposed that the first scheme be given first priority⁴⁹².

Kakoromone market: Below Kakoromone market, a river with very clean water flowed near the hospital. The medical officer suggested its improvement by building

489 Walmsley C.H (1937). Tour of His Excellency in Central Province. Kenya National Archives, DC/MERU/2/15/11, Ref: D.357/117/2/27/1, 5th August 1937.

490 Walmsley C.H (1937). Tour of His Excellency in Central Province. Kenya National Archives, DC/MERU/2/15/11, Ref: D.357/117/2/27/1, 5th August 1937.

491 Secretary, Indian Merchants Association (1937). Water Supply, Meru Township. Kenya National Archives, DC/MERU/2/15/11, 17th August 1937.

492 McKeag V.M (1937). Statement of Population and its Distribution. Kenya National Archives. DC/MERU/2/15/11, Ref: PW.8/4/7/1447, 2nd November 1937.

a concrete wall round it and insertion of two short piping into the wall. In 1930, Dr. Wilkinson and the Medical officer had protected two springs at Kisii in the same way, which greatly increased the output. He estimated the cost of this work as 150 shillings. This meant a clean supply for the market that used furrow flowing behind the dukas in which everything was washed⁴⁹³.

By 1948, the DC could not see any probability of large-scale industry requiring water. There was only one timber mill about two miles from the township. However, owing to a new township plan under implementation, the DC predicted a population increase. Meru Township was the headquarters of a district covering an area of 3,600 square miles, and with a population of 280,000. A hotel was being expanded and because of its scenery, fishing and big game, the district attracted tourists in considerable numbers. A new Government teacher training centre was being built two miles from Meru, while the Methodist mission was expanding the boys' secondary school and building a new girls' school⁴⁹⁴.

By 1948, the only piped water supply in Meru was the small hospital supply to the staff, foreman's house, nursing sister house and PWD yard. The remaining government houses were supplied from the same spring with water carried on heads of the prisoners. The unofficial population made their own arrangements of how to acquire water. Starting from 1948 the supply to the hospital catered for the hospital bucket-washing centre the new maternity ward and the new housing opposite the PWD yard. According to the DC, the flow was insufficient. The DC proposed an installation of a proper piped water supply serving the hotel, Bazaar, government training centre for teachers, Methodist mission, secondary school and the proposed mission school. He requested for a high priority and urgent presentation of the proposal to the Development and Reconstruction Authority (DARA) to get funds for carrying out the work. The work, he stated could go hand in hand with the proposed hydroelectricity scheme discussed with the director of public works in April 1946⁴⁹⁵.

By June 1949, Meru was the only district headquarters in province without a piped water supply and except for hospital; the prisoners carried all water for the government employee houses in buckets. The PC, (Windley E.H) lamented that various presentations had been made to the PWD at various times to survey a water supply for Meru but without positive response. The late director of public works, (Colonel Boyd) on his visit to Meru had suggested on utilisation of the adjacent

493 Medical Officer (1945). Water Supply near Kakoromone Market. Kenya National Archives, DC/MERU/2/15/11, Ref: 45/14/45, 8th February 1945.

494 District Commissioner, Meru (1948). Meru Township Water Supply. Kenya National Archives, DC/MERU/2/15/11, Ref: PW.8/3/4/54, 8th October 1948.

495 District Commissioner, Meru (1948). Water Supplies-Meru Township. Kenya National Archives, DC/MERU/2/15/11, Ref: PW.8/3/4/49, 17th August 1948.

Ntontini falls to provide both a water supply and an electricity power to Meru. In his address to the chief secretary, the PC recounted the water demand in the township including the hotel, the Indian shops, and the government training centre for teachers among others⁴⁹⁶.

Typhoid fever outbreak: The medical officer in charge, A.H Barwell, reported two cases of typhoid fever in Meru Township. He observed that except for the hospital, the water supply was extremely bad despite close proximity to Kazita River. He was completely dissatisfied with the existing state of affairs in developing Meru for the both the boma and the township. Following this, in August the priorities committee gave the issue of Meru water supply was given a class 'B' priority for investigation⁴⁹⁷.

Regardless, by 1950, the Meru township water for all purposes was still fetched by the prisoners serving hard labour sentences in the Meru prison. One of the reasons given for this was the expense. The district commissioner suggested lying of pipes to all new permanent buildings where plots were being built according to the development plan underway. He suggested obligating all leaseholders to running water laid on thus increasing the revenue or at least extra capital outlay⁴⁹⁸.

The Kazita River in the southern part of the township was the only suitable source of supply. It was projected to pump by means of a hydram to the purification plant on a higher ground, from where water would flow by gravity to the distribution system. Considering the nature of the river, water purification treatment expected to be carried out were coagulation, sedimentation, filtration and sterilisation. A reservoir of 75708 litres was considered adequate. The reticulation system was designed for 227125 litres per day. The estimated cost of the scheme was 8460 pounds and levied 3 shillings per 4.5 m³. At full development, the proposal argued, the revenue accruing to the scheme would show a profit over all recurrent charges⁴⁹⁹.

The water resources authority awarded priority 'A' to the proposal for investigation. Squires expected the review of the proposal in order to award a construction priority. If awarded the priority 'A', on construction, which Squires proposed, it would be taken to Development and Reconstruction Authority (D.A.R.A.) for acceptance⁵⁰⁰.

African Water supply operator: The hydraulic engineer wanted a Meru (African) to be trained as a water supply operator. The operator had to be qualified in standard

496 Windley E. H (1949). Meru Water Supply. Kenya National Archives, DC/MERU/2/15/11, Ref: PW.14/6/57, 17th June 1949.

497 Barwell, A. H (1949). Typhoid Fever in Meru Township. Kenya National Archives, DC/MERU /2/15/11, Ref: 233/13/49, 19th June 1949.

498 District Commissioner, Meru (1950). Meru Township Water Supply. Kenya National Archives, DC/MERU/2/15/11, Ref: PW.8/3/4, 19th May 1950.

499 Squires H.J (1951). Meru Water Supply. Kenya National Archives, DC/MERU/2/15/11, Ref: D.2238/117/2//27/1,16th February 1951.

500 Squires H. J (1951). Meru Water Supply. Kenya National Archives, DC/MERU/2/15/11, Ref: D.2238/117/2//27/1,16th February 1951.

six elementary or equivalent examinations. The commencing salary was 48 pounds per annum after training in Nyeri. M'Murithi Mwithiga was selected for position and reported to Nyeri on 1st September 1951⁵⁰¹.

The water operator started work on 1st August 1952. He was responsible for running the ram and treating water occasionally and reported to inspector of water supply at Nanyuki. The kiosk attendant and the two labourers reported to him. The kiosk attendant sold water between the hours of 7.00am to 10.00am and 3.00pm to 5.00pm daily. He took the daily collection to the Cashier at the DC's office. The two labourers did the general maintenance work including daily opening of the scour valves and clearing the path over the rising main daily to the riverside works. The treatment works were to be fenced and a hedge planted with shrubs and flowers to beautify it⁵⁰².

Water supply for the township market: The African district council demanded for the second water supply kiosk for Meru Township. Meru township market was opened daily and was attended by about 1000 persons. These people drank water while in the market.

However, greatest demand came from the permanent residents. There were thirty African shops, hotels etc. and one laundry at the market place. The shop owners lived on their premises with their families. In addition, there were several residential houses and huts in the area. An estimated three hundred people would draw water from the proposed kiosk. At the time, water was drawn from different streams a kilometre away. The District Officer estimated a monthly demand of 341 cubic metres⁵⁰³.

By October 1952, the Meru water supply was working but only providing water for the Pig and Whistle Hotel and to the water kiosk. Mr. Homan, the District Commissioner, considered this absurd and uneconomic. This called for augmentation. Funds for the augmentation of Meru water supply were expected in 1955/56⁵⁰⁴.

Water charges: The hydraulic engineer stated that a special agreement on water levies could be entered into with consumers licensed as water retailers and selling water by the 18 litre debe. Ministerial approval was received to charge 2.50 shillings per

501 Wilkinson N.C (1951) Water Supply Operator. Kenya National Archives, DC/MERU/2/15/11, Ref: PW.8/3/4, 29th August 1951.

502 Divisional Engineer (1952). Meru Water Supply. Kenya National Archives, DC/MERU/2/15/11, Ref: 7/1/6/1/158, 31st July 1952.

503 Nimmo J.R (1951). Meru Water Supply. Kenya National Archives, DC/MERU/2/15/11, Ref: PW.8/3/4/100, 21st September 1951.

504 Senior Engineer (1956). Water Supply Augmentation. DC/MERU/2/15/11, Ref: HYD.1/6/32, 28th September 1955.

4.5 m³ to all licensed retailers provided that the standard rate to consumers of two cents per debe was no exceeded. This rate was effective as from 1st august 1955⁵⁰⁵.

Maua Water Supply: The work on Maua Water supply was expected to start in July or August 1956 and take six months. The majority of skilled labourers working in Meru by June were transferred to Maua. The skilled labourers were normally residents of Nanyuki. The Inspector of Water Supplies permitted the labourers to be with their wives in Maua⁵⁰⁶.

Upper Abothuguchi Scheme: In March 1962, the executive engineer, J.B. Finegan with Mr. C.K. Gachie visited the Upper Abothuguchi scheme area. The object of the scheme was to provide an individual water supply by gravity to all farms situated in the area of 3,000 acres or approximately 300 farms. It was agreed that the quantity of water required was 465 litres per day for each farm plus 95 litres per day for any possible increase in consumption.

Finegan visited and approved a suitable site on the Maji ya Ng'ombe River, approximately one kilometre inside the forest reserve. At that point was a convenient rock bar across the river and as it was 100 ft. in altitude above the forest edge, it was possible to command the whole scheme area. Finegan estimated the cost of the scheme as 40 to 45 pounds per farm. Survey and design were expected to start in two months' time⁵⁰⁷.

Accordingly, the capital cost of supplying each farm with 100 gallons per day together with the availability of a further 10,000 gallons per day for future extensions was 5,500 pounds⁵⁰⁸. Two schemes were proposed, these were:

Scheme "A": Was designed to be built through use of asbestos cement and plastic piping and based the quantity extracted at intake (75.7m³ per day) on a distribution pattern, which allowed 455 litres per day for extensions and a 5% allowance for increased consumption. The approximate cost per consolidated holding for the scheme was KES 1360. The total approximate cost was KES 102460 that is KES 45,000 for piping, KES 2,326 for pipe-fittings, KES 26,490 for intake and storage, 22,260 for installation costs, and KES 1,000 for transport.

505 Hydraulic Engineer (1955) Licensed Retailers of water General Notice No. 1681, Official Gazette Published 20th July 1954. Kenya National Archives, DC/MERU/2/15/11, Ref: DW:951, 7th September 1955.

506 Inspector of Water Supplies, Nanyuki (1956). Construction of Water Supplies, Maua. Kenya National Archives, DC/MERU/2/15/11, Ref: W/S.43B/2/1224, 27th June 1956.

507 Finegan J.B (1962). Meru Water Supplies, Upper Abothuguchi Scheme. Kenya National Archives, DC/MERU/2/15/11, Ref: ALD/47/6/1, 3rd March 1962.

508 Smith, B.H (1963). Meru District, Upper Abothuguchi (Muthangene) Proposed Reticulation Scheme. Kenya National Archives, DC/MERU/2/15/11, Ref: ALD/47/91, 11th March 1963.

Scheme “B”: This scheme made no allowance for future extensions hence, considerably reducing the cost. To ensure that the scheme was well balanced and an even distribution of pressures was maintained, a ring main was designed. A 4.5 m³ balancing tank and individual storage tank (455 litres on each farm gave the total storage capacity of 87.7m³. The approximate cost per farm for the scheme was 58 pounds. The total approximate cost was 4,363 pounds that is 37,267 shillings for piping, 2,116 shillings for pipe fittings, 20,490 shillings for intake and storage, 22,260 shillings for installation and 1,000 shillings for the transport.

Preference was given to scheme “A”. The Ministry considered applying to UNICEF for materials necessary for implementation of phase one only, which involved construction of: a pipeline from the intake to the first tank, the first tank, middle pipeline, the second tank and the sanitation facilities in the area. On the other hand, Meru county council was responsible for: supplying labour and funds for construction works, paying the transport charges for UNICEF material from Mombasa to the site and supplying the local material such as sand, aggregate stones, timber etc.⁵⁰⁹.

By 1983, Meru was a municipality and the district headquarters for Meru District, Eastern province. Meru is situated on the North Eastern slopes of Mt Kenya and is 290km from Nairobi at an altitude of 1700 metres above sea level.

The existing water supply was extracted from Gatabora River where it flowed by gravity from the intake to the treatment works at the edge of the town and continued by gravitation to the township. The existing treatment works were consisted of; composite sand filter, coagulation basin, old sand filters, chlorination stands and one clean water tank with office store and staff housing. Only augmentation of the existing water supply was included in the MUWS programme. The consultant was Carl Bro Kenya Ltd and the contractor was Mowlem. The scheme was constructed in 1976 and 1977 and was commissioned in 1977 at a cost of KES 5.5 million⁵¹⁰. The population and water demand was as shown in Table 3.27.

Table 3.27: Population and water demand projection in Meru by 1975

Year	1975	1985	1995
Population	6000	9,800	16,000
Demand (m ³ per day)	800	1400	2264

509 Githumbi J (1963). Upper Abothuguchi Water Pipeline, Meru district. Kenya National Archives, DC/MERU/PW/2/15/7, Ref: 29/1053/13, 22nd July 1963.

510 Hunn G (1983). Progress Report About Water Projects included in the Minor Urban Water Supply Programme. NORAD –Coordinator/MOWD. Nairobi Ref: WD/1/2/5. 10th June 1983.

The MUWS programme tasks included 2.3km long gravity main augmentation, construction of 1.1km 100-150mm pumping line to new 300 m³ reservoir, augmentation of 13km of distribution lines and augmentation of existing treatment works. The ultimate capacity of the treatment plant was 1784 m³ per day, and ultimate population 15,093 occupying an area of 1.86km².

On an inspection field visit in 1983, the small sand filters were found not working; the horizontal coagulation basins were full of algal growth and had not been cleaned for two years. The capacity of the treatment plant was insufficient to meet the demand and the treatment works were therefore by-passed for the excess water required. A temporary line had been laid from the raw water main directly to clean water tank. It was therefore strongly recommended that the design and construction of the scheme be investigated to determine the rehabilitation and extension works required. The quality was good and therefore full treatment was not necessary. Six million shillings were recommended for rehabilitation⁵¹¹.

An evaluation in 1989 by Nor Consult Consulting Engineers, Architects and Economists revealed that the supply was less than the demand though the general condition was fair⁵¹².

Muthara Water Supply: By 1983, Muthara was a small market centre in Meru district, eastern province. Muthara centre is approximately 23km east of Meru and 313km north east of Nairobi. Prior to MUWS programme, there was no piped water supply. Water was fetched from furrows down the hills (Figure 3.24) and carried in various receptacles.



Figure 3.24: View of steep access to the intake⁵¹³.

511 Hunn G (1983). Progress Report About water Projects included in the Minor Urban Water Supply Programme. NORAD –Coordinator/MOWD. Nairobi Ref: WD/1/2/5. 10th June 1983.

512 Nor consult A. S (1988). Development of an Integrated Physical/Financial/Socio-Economic Monitoring and Evaluation Programme for Water Supply Schemes, Draft Final Report, Report No. 9. Ministry of Water Developmentt, Republic of Kenya.

513 Hunn G (1983). Progress Report About Water Projects included in the Minor Urban Water Supply Programme. NORAD –Coordinator/MOWD. Nairobi Ref: WD/1/2/5. 10th June 1983.

The Muthara water supply was constructed as part of Tigania water supply which was included in the rural water supply programme. The scheme was completed in 1977 at a total cost of approximately KES 5million. A total amount of KES 1.5 million was charged to MUWS which was approximately 30% of the entire scheme. This proportion was reasonable.

The scheme abstracted water from Mikurwe spring intake. The water gravitated to a 100 m³ storage tank one kilometre downstream of the intake where chlorine was added. No other treatment was required and water gravitated to the rest of the projects. The project was extremely simple and the operational cost was low since treatment and pumping were avoided⁵¹⁴.

An evaluation carried out by Nor Consult in 1989 found out that there were no data at all available to analyse operational and financial aspects of the MUWS project⁵¹⁵.

Embu Water Supply: Embu town started in 1906 when a British Government agent set up a military camp. At around 1925 it became a chief's camp and grew to become the seat to the African Local Council in 1940 with a couple of Asian business activities. Embu town became the District Headquarters in 1963 and the Headquarters of Eastern Province the same year. It attained the status of Urban Council in 1964 and Town Council status in 1971. In the period 1971 – 1977 the council attained Municipal status with an area of 24km². The boundaries have since been extended to cover an area of 84 km² including Kangaru Ward, Itabua Ward and Nthambo Ward.

Embu Water Supply project became operational in 1949. The project was meant to serve a small European and Asian Community of 3,000 and Izaak Walton Inn. The water demand by then was approximately 133 m³ per day. This was sourced from Kapingazi River (later known as Rupingazi River). The intake and treatment works were later enlarged by constructing two parallel lines of 150mm diameter pipe from the same source with about 600 m³ per day.

Other Water development works in eastern province by the government started in Embu District, probably due to adequate water supply from rivers and springs. In August 1960, Mr. Mulholland surveyed and designed the following three proposed pipelines at the request of the District commissioner.

514 Hunn G (1983). Progress Report About water Projects included in the Minor Urban Water Supply Programme. NORAD –Coordinator/MOWD. Nairobi Ref: WD/1/2/5. 10th June 1983.

515 Nor Consult A.S (1988). Development of an Integrated Physical/Financial/Socio-Economic Monitoring and Evaluation Programme for Water Supply Schemes, Draft Final Report, Report No. 9. Ministry of Water Development, Republic of Kenya.

South Ngariama Grazing Scheme: This was planned to pump 10000 gallons per day for a distance of two kilometres west of Rupingazi River.

A gravity pipeline from Kiangombe Hill: This was designed to deliver 20000 gallons to a storage tank in Karie area.

A gravity pipeline from Thuchi River: This was intended to pump water for eight kilometres to the area east of Ishiara and deliver 10000 gallons per day⁵¹⁶.

South Ngariama Grazing Scheme: The best point at Rupingazi River for an intake was at the waterfall at Ikurugu. It was possible to install a ram and a water pump at the point. There was an existing furrow used for driving a posho mill belonging to ex-chief Kombo. Messrs. Gibson, Finegan and Mulholland proposed using furrow as a supply for the ram. Further, they proposed widening and properly grading the existing furrow. An alternative furrow was expensive due to the big height of the bank⁵¹⁷.

A concrete surge box at the end of the furrow with a 30 metre-long drive pipe was suggested. This was to be laid in a perfectly straight line from the surge box to the hydram with a fall of five metres. A 10000 gallons concrete storage tank constructed at the end of the pipeline complemented this. This was proposed with provisions for future gravity lines from the tank.

According to the scheme, the delivery pipes had to pass across the river and was therefore to be suspended some 4.5 metres above the water from guy wires fastened to the trees. They had to be strong enough to withstand the weight of the baboons, which would use them as a bridge. They suggested for delivery pipes able to take approximately 7 gallons per minute. The total estimates including piping, hydram, valves, roll fencing wire, concrete tank, labour and transport by both rail and road were 1,493 pounds⁵¹⁸.

Kiangombe Hill, Karie Area: A gravity pipeline was planned from Kiangombe Hill to provide water for human and stock consumption in Karie village. It was expected to replace the use of water holes in the bed of a river. A 20000 gallons storage tank was to be constructed at the end of the line. The source of supply was several springs high up on Kiangombe Hill and the intake chosen was just below a small waterfall, which was at the convergence of two small valleys.

A concrete weir at the point of intake position on a solid rock of 0.6 metres high by 4.5 metres wide was to be constructed with a pipeline through the weir

516 Executive Engineer (1960). Embu District Water Supply. Kenya National Archives, DC/EM-BU/2/2/1, Ref: ALD/48/1/95. 30th August 1960.

517 Executive Engineer (1960). Embu District Water Supply. Kenya National Archives, DC/EM-BU/2/2/1, Ref: ALD/48/1/95. 30th August 1960.

518 Executive Engineer (1960). Embu District Water Supply. Kenya National Archives, DC/EM-BU/2/2/1, Ref: ALD/48/1/95. 30th August 1960.

and a coffee wire cage or screen placed round the inlet to sieve the water. The line was to be buried at a minimum depth of 18 inches and provide a maximum flow of 14 gallons per minute. At the end of the line, a gate valve just before the ball valve control into the storage tank to ensure hydraulic efficiency was to be installed. The total estimate for the piping, valves, concrete tanks, concrete weir, and labour for trenching and transport for both the road and railway was 3,362 pounds⁵¹⁹.

Ishiara water supply Proposal: A pipeline was designed from Thuchi River following instructions from the district commissioner, Embu to provide water for general consumption in the dry area between Ishiara village and the Tana River. The line was approximately eight kilometres long with 10000 gallon storage tank at the end. Future gravity lines designed to run from the tanks were to be provided for with some off take points along the line.

The intake point was a small waterfall approximately 640 metres above the point on the escarpment near Ishiara where the road was closed to the river. A concrete weir was to be constructed at the intake and a filter of coffee wire screening the opening was put. The pipeline was designed to take a maximum flow of 17 gallons per minute. The total estimate including the price for increased pipe lengths, the valves, concrete weir at intake, labour for trenching and transport was 4,527 pounds⁵²⁰.

In 1973, Embu was the provincial headquarters for Eastern province and was situated 142km north east of Nairobi. Embu water supply original proposal in 1973 was just to augment the existing schemes by increasing the capacity of the treatment works and extending the distribution network. The existing Embu Urban water supply abstracted water from Kapingazi River which had a catchment area consisting of mainly of cultivated land. The scheme had a capacity of 1000 m³ per day and comprised of raw water gravity main, full conventional treatment and gravity distribution network with estimated cost estimated of KES 0.4 million. Rather than augment the existing supply, completely new intake, new treatment plant and a major improvement to pipelines and reservoirs⁵²¹ at a cost of KES 60 million which involved a completely new intake. The estimated population and demand are as shown in Table 3.28.

519 Executive Engineer (1960). Embu District Water Supply. Kenya National Archives, DC/EMBU/2/2/1, Ref: ALD/48/1/95. 30th August 1960.

520 Executive Engineer (1960). Embu District Water Supply. Kenya National Archives, DC/EMBU/2/2/1, Ref: ALD/48/1/95. 30th August 1960.

521 Nor Consult A.S (1988). Development of an Integrated Physical/Financial/Socio-Economic Monitoring and Evaluation Programme for Water Supply Schemes, Draft Final Report, Report No. 9. Ministry of Water Development, Republic of Kenya.

Table 3.28: Population and water demand projection in Embu by 1985

Year	1985	1995	2005
Population	28,000	67,000	171,000
Water demand (m ³ per day)	3,500	9,000	24,800

During construction of the Embu rural water supply phase in 1980, a 10km long, 150mm pipeline was laid from rural scheme to supply untreated water (chlorinated only) by gravity to the urban scheme. The capacity of the pipeline was 20 litres per second and the water was discharged into a storage tank at the urban treatment works. The total capacity of the existing scheme was increased to approximately 27000 m³ per day.

There were very little design work carried out on the urban scheme, however, the same consultant had prepared some designs for Phases II and III of Embu Rural water Supply. The rural Phase I intake had capacity expected to meet the urban demand. The original proposal in 1973 was to augment the existing water supply by increasing the capacity of the treatment works and storage and extending the distribution network at an estimated cost of 0.4 million shillings. By 1988, 2.2 million shillings had been expended, it was recommended that NORAD should finance the completion of the tank at the tune of 0.95 Million shillings as its final contribution to Embu Water Supply⁵²².

The evaluation by Nor Consult by 1989 revealed that the supply could only satisfy half of the demand. However, the general condition was fair⁵²³. The National Water Conservation and Pipeline Corporation (NWCPC) started to operate water supply services in 1988. NWCPC was by then in the process of handing over the water services to the council, which was forming a company, wholly owned by the council, to run both the water and sewerage services⁵²⁴.

Isiolo Water Supply: In 1983, Isiolo was an urban centre and district headquarters for Isiolo district, eastern province. It is situated 285km northeast of Nairobi. Isiolo water supply was designed by Howard Humphreys and Sons and constructed by Oriental Construction. It was commissioned on February 1982 at an estimated cost

522 Nor Consult A.S (1988). Development of an Integrated Physical/Financial/Socio-Economic Monitoring and Evaluation Programme for Water Supply Schemes, Draft Final Report, Report No. 9. Ministry of Water Development, Republic of Kenya.

523 Nor Consult A.S (1988). Development of an Integrated Physical/Financial/Socio-Economic Monitoring and Evaluation Programme for Water Supply Schemes, Draft Final Report, Report No. 9. Ministry of Water Development, Republic of Kenya.

524 Nor Consult A.S (1988). Development of an Integrated Physical/Financial/Socio-Economic Monitoring and Evaluation Programme for Water Supply Schemes, Draft Final Report, Report No. 9. Ministry of Water Development, Republic of Kenya.

of KES 27million. The ultimate design population was 27,200 by 1995 and the water demand was 3980 m³ per day.

Greater part of Isiolo district is situated along the broad shallow valley of the Uaso Nyiro and the adjacent plain. Volcanic rocks underlie much of the Southern part while northern part and north of Uaso Nyiro and the country around Garba Tulla has basement complex. Merti beds cover the eastern part of the district.

Isiolo district, like elsewhere in the Northern frontier district, was characterized by Nomadic lifestyle, people kept large number of livestock, which included cattle, donkeys, sheep, goats and camels. The survival of these animals depended entirely on the availability of water and grazing fields and vice versa. Thus, the development of water supplies was influenced by the presence of livestock. The Tribal clashes over grazing land and watering places was a major problem. Consequently, water supplies were developed in such a way as to keep the animals well distributed on the land to avoid both land degradation due to overgrazing, as well as the tribal conflicts over watering points⁵²⁵.

The natural wells and water holes upon which any improvement depended were categorized into the north zone and the south zone. In the north zone the wells and water holes ranged along two water courses, one whose tributaries rose at the western end of the district running to the eastern direction eventually bending south to flow into the Uaso Nyiro. The other ranged along a belt further north running from Barchuma to Arba Jahan. In the southern zone, the water holes and wells run along the main Isiolo – Wajir road and were evenly spaced along it⁵²⁶.

The Isiolo District Commissioner considered the available natural wells adequate to satisfy the requirements of the tribesmen during the rains. The wells were expected to eventually allow a complete migration from Uaso Nyiro basin during the dry period. The intermediate areas between Arba Jahan and Saricho, and between Saricho and Muddo Gashi had no wells nor water holes. The DC recommended pan digging in carefully selected sites⁵²⁷.

In 1937 a pipe line was laid down under the direction of the acting Senior Assistant Engineer, Public Works Department, Nyeri in Isiolo Township. The water was supplied from a dam in the Isiolo River, and piped to supply tanks from which the water was drawn off from sixty stand-pipes. The dam and the pipe line were completed by the end of the year⁵²⁸.

525 Dixey F (1943). Hydrographical Reports on the Northern Frontier District, Samburu and Turkana and Report on the Hydrology of Uaso Nyiro. 1943.

526 District Commissioner, Isiolo (1943). Water Supplies. Kenya National Archives. BB/7/32, Ref: PW.8/5/207, 17th September 1943.

527 District Commissioner, Isiolo (1943). Water Supplies. Kenya National Archives. BB/7/32, Ref: PW.8/5/207, 17th September 1943.

528 District Commissioner, Isiolo (1937). Isiolo District Annual Report for the Year 1937. Kenya National Archives. DC/ISO/1/1/2, 1937.

In August 1943 Isiolo water supply started its operation and it proved quite successful, though it was supplemented by fetching water from one of the military boreholes, during the days when the furrow was shut off. Dr Dixey toured the district with the District Commissioner to investigate the possibilities of improving the water supplies in certain areas away from the Uaso Nyiro⁵²⁹.

By 1948 the water supply to government personnel was done by a water tanker which cost in driver, upkeep, running etc. was approximately 250 pounds per annum, excluding consideration of charges for the maintenance and upkeep of two boreholes which were existing at the time. The two boreholes cost approximately 200 pounds per annum to maintain. The provincial headquarters were initially planned for Marsabit but a change of policy saw the headquarters shifted to Isiolo in 1948. This change in policy meant that Isiolo had to develop adequate water supplies in order to accommodate the activities that went with provincial headquarters. In response to the change, the District Commissioner, Mr. Ellis in his letter to the Provincial Commissioner suggested taking advantage of the existence of Development and Reconstruction Authority funds for township water supplies.

By 1949, no piped water supply for domestic use existed in Isiolo. A 1600 litre capacity army type, water tanker supplied water from a borehole situated three kilometres away on the Kipsing Road. The DC had bought and repaired the tanker at 132 pounds in 1947 to make it roadworthy. Two years of daily use ran it down and it required urgent overhaul. In fact, in the steering, engine, gearbox, spring hangers, shackles, pins and bushes needed a thorough re-examination and probable replacement. However, he was apprehensive that even with such replacement, it was not possible to guarantee that it would be in perfect condition. The DC hence suggested purchasing a new engine and chassis and then fitting with a water tank for accost of 655 pounds.

The breakdown of the old water tanker put a huge strain on the other administrative vehicles and water drums, which were in short supply at that time are shown in Table 3.29.

The Water Resources Authority Priority Committee met in May 1949, after confirmation of Isiolo as the N.F.D headquarters, and gave Isiolo Water Supply a preference. However, surveyors were in short supply and many were actually Asian. Amongst the renowned Asian surveyors was Ajit Singh. He was working at Nyeri and hence could not proceed to Isiolo⁵³⁰.

529 District Commissioner Isiolo (1943). Isiolo District Annual Report for 1943. Kenya National Archives. DC/ISO/1/3, 1943.

530 Divisional Engineer (1952). Isiolo Water Supply. Kenya National Archives. BB/PC/EST/7/34, Ref: 7/1/7/1/74, 3rd June 1952.

Table 3.29: Population dependent on water tanker in Isiolo by 1949

Consumer	Number served
European houses	7
Asian and African houses	11
African lines (men, women and children)	110
Police lines (men, women and children)	100
Prison population	50
Total	278

In 1952 an application for a furrow supply to the boma for irrigation purposes and another furrow to run from Uaso Nyiro to Samburu Buffalo springs was made. By this time, the cost of maintaining the water lorry and the boreholes at Isiolo had exceeded 1000 pounds per annum. The furrow running from Isiolo River to the officer's compounds, registered under the District Commissioner, Isiolo was operational⁵³¹.

Township supply: The permit for water abstraction of 73400 litres per day for the Isiolo piped water supply was given in 1952. The Divisional Engineer expected to complete the scheme by 1st April 1952. After 14 months effort, the Isiolo township water supply commenced functioning on 30th November 1953, five months behind the schedule. The water rights for the township furrow for abstraction of 3091 m³ per day were issued in 1952. At the same time, a request for furrows to serve irrigation purposes in the Isiolo Boma were made⁵³².

Well digging: Mr. Perera of Garba Tulla undertook as urgent a well digging Programme following the 400pounds vote form the African Trust Fund, a vote meant for improvement of water supplies. Well digging work started but a team of Turkana labour employed to dig a well at Duse struck basement complex at about 50 ft. and abandoned further work. Unfortunately, similar fate befell the work at Boji on the Isiolo – Garba Tulla road but at 10 ft. overall, well digging exercise was an absolute failure⁵³³.

Merti prison camp water supply by 1952: The site chosen for the camp was half-way between the two Public Works Department beacons on the Isiolo Merti road, about 23 kilometres from Merti trading centre. The camp water supply was supposed to come from Uaso Nyiro. No water borne diseases such as typhoid or dysentery

531 Divisional Engineer (1952). Isiolo Water Supply. Kenya National Archives. BB/PC/EST/7/34, Ref: 7/1/7/1/74, 3rd June 1952.

532 Divisional Engineer (1952). Isiolo Water Supply. Kenya National Archives. BB/PC/EST/7/34, Ref: 7/1/7/1/74, 3rd June 1952.

533 Dixey F (1943). Hydrographical Reports on the Northern Frontier District, Samburu and Turkana and Report on the Hydrology of Uaso Nyiro. 1943.

was known to be found in this part of Northern Frontier District. According to the medical department, the most suitable type of pit latrine was the deep trench type⁵³⁴.

Borehole supply: In 1953, there were few boreholes in Isiolo district. One was at mile 46 on Wajir road and was continually out of commission, at its best, produced 227 to 272 litres of water per hour. Its water was slightly blackish or saline. A borehole called Lobongito, put up to prevent border incidences with the Wadorobo, and reduced significantly the border clashes over grazing and watering points. No watering fees were charged at these boreholes⁵³⁵.

The Uaso Nyiro River: The rate of flow of Uaso Nyiro River had slowed gradually for thirty years, between 1913 and 1943. This was occasioned by the changes in climatic conditions and increased occupation of the upper catchment of the river by both the European settlers and the Natives. According to the report collected from the elders, the flow in 1916 and thereabouts was quite high, The flow by 1926 was substantial and reliable⁵³⁶.

According to the chairman of the Nanyuki farmers association, Mr. Toad, a hydrographic survey of the Uaso Nyiro catchment area was compiled in 1940. The dry season flow of the Uaso Nyiro River and its tributaries was 85Cusecs. At the height of floods, the flow exceeded 1000cusecs in some areas especially below Archer's post⁵³⁷.

Uaso Nyiro River was the Major source of water in the Isiolo district, and its source was established in Mount Kenya. The main water problem of the district was related to variations in the flow of Uaso Nyiro.

Water conflicts: European farmers and the natives' squatters drew water from the headwaters of Uaso Nyiro for irrigation purposes. This considerably affected the levels of water in the lower reaches of the River. Actually, the use of water for irrigation in the upper Uaso Nyiro caused zero flow in the lower reaches below Archer's post thereby depriving some thousands of natives and their stock water. As a result thousands of cattle died due to lack of water in 1943.

The water board decided that the amount should be divided between the settled area and the nomads in the N.F.D on 50/50 basis. However, the settler community was not consulted, which prompted a lot of protest from the Nanyuki Farmers As-

534 Medical Department (1952). Proposed New Camp-Merti. Kenya National Archives, BY/6/16, Ref: 8/1/5/52. 1st September 1952.

535 Divisional Engineer (1952). Isiolo Water Supply. Kenya National Archives. BB/PC/EST/7/34, Ref: 7/1/7/1/74, 3rd June 1952.

536 Dixey F (1943). Hydrographical Reports on the Northern Frontier District, Samburu and Turkana and Report on the Hydrology of Uaso Nyiro. 1943.

537 Dixey F (1943). Hydrographical Reports on the Northern Frontier District, Samburu and Turkana and Report on the Hydrology of Uaso Nyiro. 1943.

sociation. The association passed a resolution urging the government to implement water conservation schemes to provide water for the nomads from other existing sources. The association argued that army had proved existence of ground water in the lower reaches of Uaso Nyiro and found springs at depth of 18 metres and less. The farmers' association suggested to the government that it was practicable to construct earth dams, 16 kilometres apart, to supply troughs for watering the stock⁵³⁸.

In 1944, the government without notice or consulting those concerned closed down all the furrows for irrigation except those on tapering streams. In regard to the closure the East African Standard (1944) argued that only a mere fraction of water reached the Archer's post due to loss seepage, evaporation and transpiration between the 241 kilometre stretches. In support of the farmers' association, the newspaper claimed that the nomads required only half a cusec (approximately 1.14 million litres a day) therefore the allocation of 147 million litres per day the 50/50 principle.

However, regardless of the protest from farmers, the chairman of the Water board was adamant on 50/50 principle. The hydraulic engineer estimated the total extractions in the settled area, including extractions by the military to be approximately 147 million litres per day⁵³⁹.

Collection of public works revenue: Chief accountant expressed concern that the DC ignored the scheduled tariff for the Isiolo Water supply for minimum rates and bulk rates. In 1955, the bulk rates were increased by 60 cents, from 2.40 shillings to 3 shillings per 4.5 m³ for consumption in excess of 136 m³ per month. In addition, increment of 2.50 shillings for the minimum rate was made. This was in respect to water provided by the public works department⁵⁴⁰.

By 1955, Isiolo water supply was no longer able to meet the demands from the boma and the township. Over 77 m³ were used every day, which was more than the existing plant could provide. Households were therefore asked to exercise economy in their use and refrain from using water for washing cars, building purposes or for watering gardens. To allow the reservoir to be filled, water was only opened from 6am to 8am and 4pm to 6pm⁵⁴¹.

By 1960, the water supply in Isiolo Township was inadequate while the quality too had deteriorated visibly since 1959. This was caused by so high a demand that

538 East Africa standard (1944). Uaso Nyiro Water Problem. Kenya National Archives. BB/7/32, 4th May 1944.

539 East Africa Standard (1944). Uaso Nyiro Water Problem. Kenya National Archives. BB/7/32, 4th May 1944.

540 Chief Accountant, (1955). Isiolo Water Supply. Collection of Public Works Revenue, KENYA NATIONAL ARCHIVES BB/PC/EST/7/34, Ref: LA/WS/121A, 21st September 1955.

541 Nimmo J. R (1956). Isiolo water Supply Accounts. Kenya National Archives. BB/PC/EST/7/34, Ref:PW.8/30/138, 26th June 1956.

there were no time to close the treatment works for cleaning. An increased demand due to the staff housing for the new Divisional headquarters in Isiolo and a new building Programme in the trading area commencing later in the year was anticipated⁵⁴².

Water Supply Accounts: There were 67 water supply connections at Isiolo in 1956, the work of a clerk involved, meter reading, preparation of bills, preparation of returns, weekly preparation of form 17, correspondence, collection of water rates and preparation of receipts and maintenance of water supply register⁵⁴³.

Isiolo district desperately needed a water clerk to carry out the aforementioned duties. In addition, the records and accounts were in a disorder due to increased administration accounts and the influx of revenue. The District Commissioner requested for a clerk solely for water records and accounts. Another difficulty confronting the District Commissioner was sudden transfers of staff who left without paying their bills⁵⁴⁴.

Malks Head: At Malks Head, silt built up rapidly at an estimated rate of 500 metres per annum. This created a sand bank that prevented all flow passing east of it. In July, Uaso Nyiro flowed strongly under the Habaswein Bridge at an estimated 70 cusecs and in November, there was a fair volume towards the Lorian swamp⁵⁴⁵.

Lorian swamp: Below the Habaswein Bridge was a plain known as the Lorian plain, where Uaso Nyiro flooded annually to form the Lorian swamp. When flooded the swamp was about four to 8 kilometres width and 19 kilometres in length. It was very shallow in that the stock could wade up to about one and half kilometres from the shore and was covered by reeds and grass⁵⁴⁶.

The Isiolo River: Mr. Flint measured the flow of the Isiolo River and the furrow dam in February 1944 and found that it contained 325000 gallons⁵⁴⁷. With its origin in in mount Kenya, Isiolo River, was the source of water for Isiolo Town. The mean annual flow by 1991 was 6 million cubic metres (16,400 cubic metres per day). The Isiolo River provided domestic water for Isiolo town at approximately 2000cubic metres per day. Irrigation by then consumed about 8000cubic metres per

542 Abrams P.D, (1960). Isiolo Township Water Supply. Kenya National Archives BB/PC/EST/7/34, Ref: PW.8/30/156.

543 Nimmo J. R (1956). Isiolo water Supply Accounts Kenya National Archives BB/PC/EST/7/34, Ref:PW.8/30/138, 26th June 1956.

544 Watkins H.G (1958). Isiolo Water Supply Records and Accounts, Kenya National Archives Bb/PC/EST/7/34, Ref: HW.10/5/4/30 TY, 17th October 1958.

545 Annual Reports, Isiolo, (1953). Kenya National Archives. Ref: DC/ISO/2/1/13, 1953.

546 District Commissioner, Isiolo (1944). Isiolo River. Kenya National Archives BB/7/32, Ref: PW.8/4, 8th July 1944.

547 District Commissioner, Isiolo (1944). Isiolo River. Kenya National Archives BB/7/32, Ref: PW.8/4, 8th July 1944.

day because the flow during the dry season were very much reduced, the possibilities for more irrigation were limited⁵⁴⁸.

Rainfall: The inhabitants named various types of rainfall as 'der' rains and the 'guu' rains the driest period was called the 'haggai'. The dams and pans were usually repaired during this season in preparation for the rainy season when they would fill up and thus provide water for the stock in the dry season⁵⁴⁹.

Dams and Pans: The District Commissioner, Mr. S.I. Ellis, oversaw the development works in the district. Mr. Classen carried out the survey on 8th March 1951 and found that conservation of surface water works in the district was restricted to the area south and west of Garba Tula. Classen investigated various water point and made recommendations on maintenance of dams, pans and wells. This involved deepening, desilting, scraping and enlarging. This was in many cases done by a group of people served by a particular facility. On other occasions, those who desired to use the facility compensated by helping in such work. To keep the pans and dams from harm and contamination, animals were watered from troughs⁵⁵⁰.

Nambala Daka was a pan on the track from Garba Tula to Kinna springs. It had large boulders at the depth of 0.6 metres which obstructed deepening. Bibi River Pan was developed from a natural depression on the south bank of the stream by scrapping the soil in the form of a dam wall. On the other hand, Matasara dams and pan were in Matasara valley. The first dam was built across a wide shallow valley. The second dam lay a one and half kilometres further and was similar to the first one. In both dams, silting was high since the soil was too shallow to permit the cutting of efficient silt traps. Some distance to the north of the stream about midway between the two dams, some holes measuring 8ft² by 8ft deep were dug in a pan.. The holes held water moderately well although it was inadequate for a large number of stock present during the rainy season. Daba was a large natural pan three kilometres south of the main Isiolo Garba Tula road. It retained water for a long period after the rains. Classen recommended construction of a silt trap supplied by feed furrows⁵⁵¹.

Classen established that temporary water storage could be efficiently provided on the easterly portion, underlain by rocks of basement system. He recommended improved pans and tanks since conditions for building dams were not suitable. The

548 Water Resources Assessment Section (1991). Isiolo Executive Summary of Water Resources Assessment Study and District Water Development Study. Nairobi, Kenya.

549 District Commissioner, Isiolo (1944). Isiolo River. Kenya National Archives BB/7/32, Ref: PW.8/4, 8th July 1944.

550 Classen G.A (1951). Engineer Geologist Report on the Surface and Shallow Water Supplies in the Districts of Moyale, Wajir, Garissa and Isiolo. Kenya National Archives. DC/GRSSA/6/13, Ref: IAS.61/230.

551 Classen G.A (1951). Engineer Geologist Report on the Surface and Shallow Water Supplies in the Districts of Moyale, Wajir, Garissa and Isiolo Kenya National Archives, DC/GRSSA/6/13, Ref: IAS.61/230.

western portion of Njombeni was underlain by rocks and was not suitable for any form of surface storage. A fair chance of ground water at a reasonable depth was found at the Kinna Springs and the springs at the Archers post⁵⁵². The location map of Isiolo district showing various sources of water supply is illustrated in Figure 3.25.

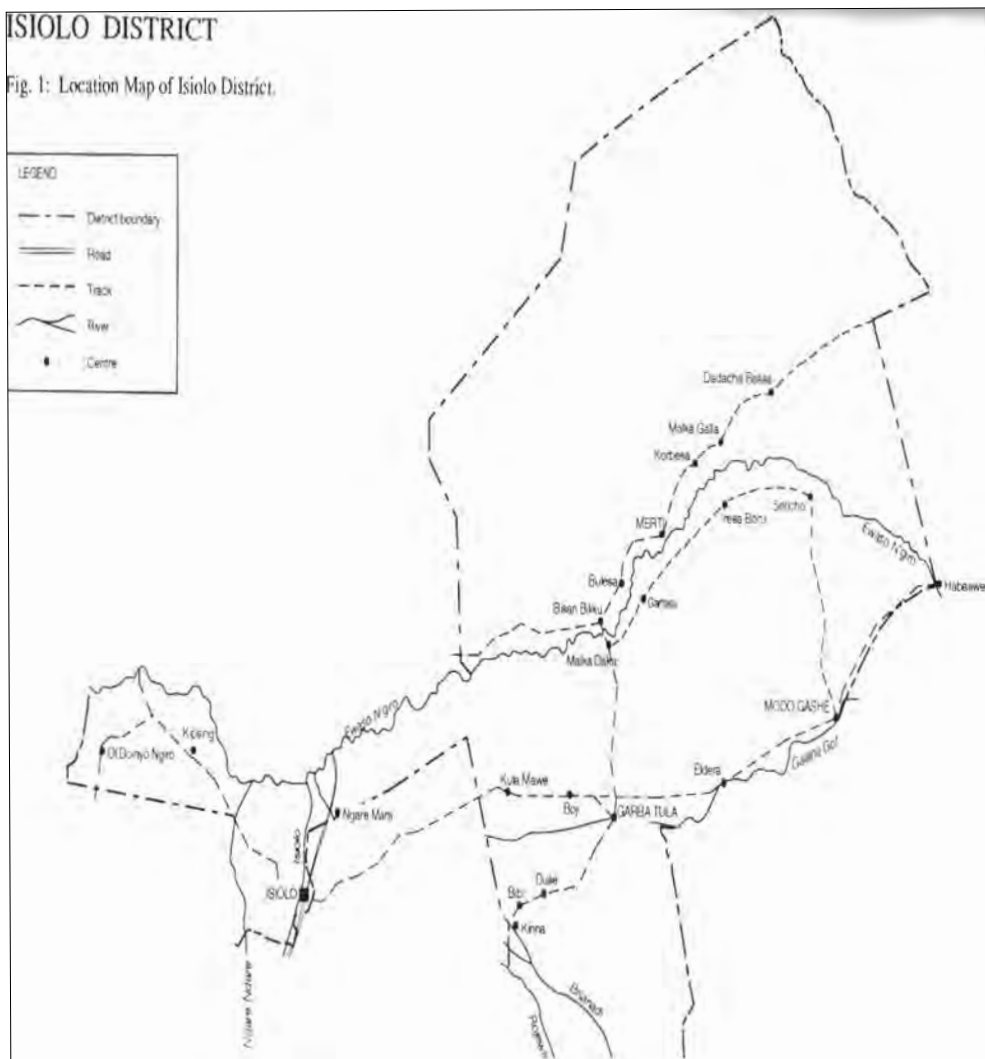

Figure 3.25: Lemsigiyo Dam in Nundato River Isiolo and the location of Ewaso Nyiro River in 1951⁵⁵³.

552 Classen G.A (1951). Engineer Geologist Report on the Surface and Shallow Water Supplies in the Districts of Moyale, Wajir, Garissa and Isiolo. Kenya National Archives DC/GRSSA/6/13, Ref: IAS.61/230.

553 Hunn G (1983). Progress Report About Water Projects included in the Minor Urban Water Supply Programme. NORAD –Coordinator/MOWD. Nairobi Ref: WD/1/2/5. 10th June 1983.

Bullesa Water Supply: Bullesa market was in Merti division, 24 kilometres from Merti town. A Dispensary, school, village, administration line and market were being built in 1973. The district health officer, proposed digging a well near the river, where the source was permanent, to improve the quality of the water. He proposed use of a mechanical pump for pumping water from the source to the storage point. He requested for 6,000 pounds for constructing the pump house, well, and a storage tank of 45.5 m³. The county council of Isiolo was expected to maintain the project after completion⁵⁵⁴.

Taking over of Water Supply at Bandas –Isiolo Buffalo Springs Game Reserve: Wario, the Isiolo County Council clerk, requested the water development department for a full takeover of the water supply at the council Bandas (where tourist stayed) in the Buffalo springs game reserve. This was impelled by the inability of the council to repair constant pump breakdowns during the year 1974. Towards the end of the year, the council installed a new machine, which operated smoothly. Wario argued that that the council was understaffed and had no personnel to look after the water supply therefore the Water Development Department should take over the maintenance of the supply⁵⁵⁵.

Due to semi-arid conditions, water supply was a major constraint in the development of Isiolo district. In 1978, in the entire district, only three minor water supplies and four boreholes with no distribution network could be counted. This state of affairs prompted more allocation in water supply works in the following five years. . In 1983, there were one major water supply, six minor water supplies, nine boreholes, nine large pans and 3 small pans. The six minor water supplies basically served the divisional headquarters and other centres with relatively high concentration of population. The major urban water supply was conventional water supply that served Isiolo Township. The existing dams and pans had problems of situation which reduced their capacity greatly⁵⁵⁶.

In 1983, water works included construction of a new weir at Isiolo River, complete with valve chambers, flow charts etc. The weir was designed to take flood water for the following 25 years estimated to flow at an average 156 m³ per second, every time it occurred. It also included a 12 km long raw water gravity line with 250 mm dimension. In addition there was a complete treatment plant with capacity of 174

554 Kibos J.S (1973). Bullesa Water Supply. Kenya National Archives, DC/ISO/4/12/1, Ref: ISO/19358/73, 10th December 1973.

555 Wario H.H.W, (1975) Taking over of Water Supply at Bandas –Isiolo Buffalo Springs Game Reserve Kenya National Archives DC/ISO/4/12/1, Ref: ISO/CC/ADC/PW/4/3/Vol.2/419, 18th February 1975.

556 Water Resources Assessment Section (1991). Isiolo Executive Summary of Water Resources Assessment Study and District Water Development Study. Nairobi, Kenya.

m³ per hour elevated backwash tank, clear water tank and a 12 km of treated water gravity main, with 250 mm dimension⁵⁵⁷.

A site visit conducted later in 1983 observed that the construction was of good standards, however, there was an extensive silting, no proper access road from treatment works of the intake. Only two of the six electric pumps for chemicals were working and one out of for stirring pumps for the flocculation was out of order.

According to Nor Consult consulting Engineers, Architects and economists, the production by 1989 met the demand⁵⁵⁸.

Nol-Turesh Water Supply: Occasioned by shortages of water on their main line stations between Kiu and Makindu, the East African railways and harbours endeavoured to obtain water from Local springs. The problem was solved by large-scale means of gravitating water from Kilimanjaro. The pipeline not only solved the water problem for its stations but also Maasai and Ukamba stock owners between the Kilimanjaro and the Mombasa/Nairobi railway line⁵⁵⁹.

The railways started the survey work on the Kilimanjaro-Emali pipeline in 1952/53, completing it in august 1953. The pipeline route ran all the way from Kilimanjaro at a place called Nol-Turesh near Loitokitok to Emali at Sultan Hamud. The pipeline was to carry 1,364 m³ of water per day. The pipeline was also known as the Nol-Turesh- Emali Pipeline.

The railway surveyor estimated the total flow from the spring forming the source at Nol-Turesh pipeline as 20,457 m³ per day in May 1952. This flow was however, seen as being on the higher side following heavy rains in 1951. The water from the springs forms the Nol-Turesh River, which flows, into a swamp near Soit Sambu (Oltital area). This river was at the time used by the Maasai for watering their stock⁵⁶⁰.

The pipeline was constructed in 1954/55 so that by June 1955 the pipeline was operational. Nevertheless, the pipeline was opened officially on 24th March 1956. Just like the Ngong pipeline the Nol-Turesh pipeline ran through Maasai territory and as such the Maasai were always favoured with free water for their thousands of stock along the pipeline. In the case of Nol-Turesh, there were five watering points along the pipeline, each of which was giving 45460 litres per day to the Maasai. There were four take off points between Nol-Turesh and Sultan Hamud and only

557 Hunn G (1983). Progress Report about Water Projects Included in the Minor Urban Water Supply Programme. NORAD, Nairobi.

558 Nor Consult A.S (1988). Development of an Integrated Physical/Financial/Socio-Economic Monitoring and Evaluation Programme for Water Supply Schemes, Draft Final Report, Report No. 9. Ministry of Water Development, Republic of Kenya.

559 Colony and protectorate of Kenya (1953 – 1962). Loitokitok Emali pipeline. Kenya National Archives, Ref: PC/NGONG/1/6/32, Nairobi, Kenya.

560 Colony and protectorate of Kenya (1953 – 1962). Loitokitok Emali pipeline. Kenya National Archives, Ref: PC/NGONG/1/6/32, Nairobi, Kenya.

one between Emali and Simba. Although the railway passed through Murueshi area, it did not supply any water for stock watering in this area as the area was at the time well-watered with boreholes. At a point close to the Emali end of the pipeline the Ukamba people were provided with 22730 litres of water and 36368 litre circular tanks with watering troughs⁵⁶¹. An illustration of Nol-turesh water supply system is made in figure 3.26⁵⁶².

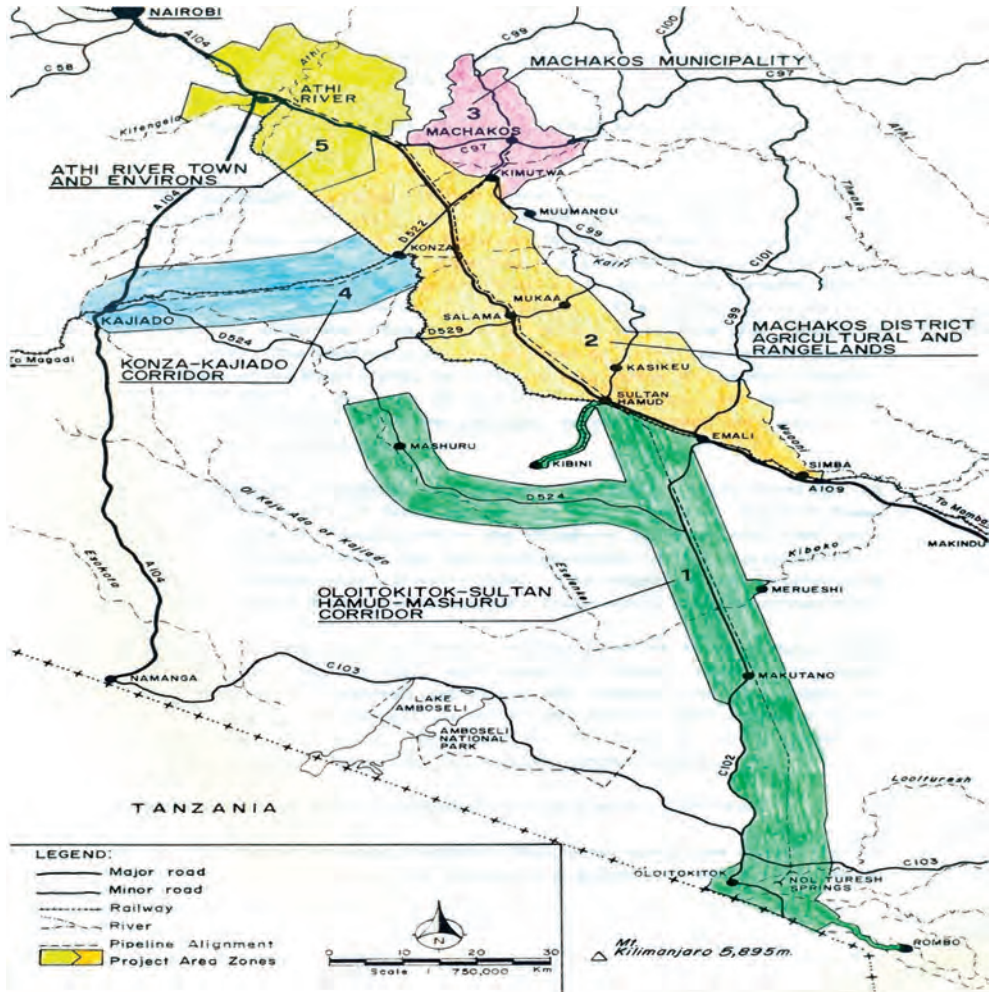

Figure 3.26: Nol Turesh water supply pipeline corridor by 1956⁵⁶³

561 Colony and protectorate of Kenya (1953 – 1962). Loitokitok Emali pipeline. Kenya National Archives, Ref: PC/NGONG/1/6/32, Nairobi, Kenya.

562 Hunn G (1983). Progress Report about Water Projects Included in the Minor Urban Water Supply Programme. NORAD, Nairobi.

563 Hunn G. (1983). Progress Report about Water Projects Included in the Minor Urban Water Supply Programme. NORAD, Nairobi.

Kenya Railways was responsible for water supply to the various stations along Mombasa Nairobi railway line. Water from this source was supplemented when necessary by local boreholes and water hauled to the station by rail tankers. Water from Nol Turesh springs was fed to the railway stations through a 106 km steel pipeline, designed to supply 2160 m³ per day. Water was also provided to pastoralists and their livestock, and also to the general public. The stations at Ulu and Konza were not supplied from Nol Turesh pipeline. In 1921 Ulu, had developed water from a well, and in some localities success was achieved at a depth between 30 and 30.5 metres. The development of farms in these areas was greatly hindered by the failure of rains and consequently lack of water and grazing⁵⁶⁴. Ulu station relied entirely on water tanked from Nairobi while Konza station had its own borehole, though sometimes supplemented by railway tankers⁵⁶⁵.

Dealing with the Maasai watering along the pipeline was never easy. The water points were sited to open grazing areas creating precariously balanced grazing schemes for the Maasai. The Maasai were however in the habit of damaging the wash out valves along the pipeline in order to obtain water for their stock without trekking for long distances.

This state of affairs led to the closing of the take of points for section of the Maasai as a reprisal for their misconduct. This however was deemed unreasonable because: (i) it would have led to the death of calves due to thirst had it been done during the dry season; (ii) it could have led to the spread of diseases (iii) caused considerable hardship to women and children and (iv) upset the management of grazing schemes⁵⁶⁶.

As time went by the dependency of the railway on water from the Kilimanjaro pipeline became less and less due to the change over from steam-powered locomotives to diesel. The railway thus allowed more people to connect to this pipeline and hence opening up a debate on the possibility of the government taking over the pipeline for the benefit of the people⁵⁶⁷.

As at 1980 the pipeline capacity was 2000m³ per day. The pipeline length was 98 km of which 54km was 200 mm diameter while 44km were 255mm diameter. As at 1980, the pipeline was 25 years old and the pipes had started yielding. The maintenance costs had escalated to Kenyan pounds 15,000 annually and rising.

564 Senior Commissioner (1922). Report by the Senior Commissioner for the Nine Months Ending December 31st 1921. Kenya National Archives. PC/CP/4/2/2 1922.

565 Ministry of Water Development (1988) Nol Turesh Water Project: Quarterly Progress Report-September 1988.

566 Colony and Protectorate of Kenya (1953 – 1962). Loitokitok Emali pipeline. Kenya National Archives, Ref: PC/NGONG/1/6/32, Nairobi, Kenya.

567 Colony and Protectorate of Kenya (1953 – 1962). Loitokitok Emali pipeline. Kenya National Archives, Ref: PC/NGONG/1/6/32, Nairobi, Kenya.

Taking over of the pipeline by MoWD meant that funds had to be set aside for rehabilitation, extension and maintenance thereafter⁵⁶⁸.

The Nol -Turesh pipeline was adequately maintained by the railway personnel, but being the major and sometimes the only source of water in the region, the pipe was often tampered with, manholes were broken and washouts were left open, resulting to excessive water losses along the pipe. Valve chambers and pipe joints also needed frequent repair. By 1988, the five towns depending on the railway pipeline were rapidly growing rendering the water inadequate.

The project area was served had projects built and operated by Ministry of Water Development, town councils, other public authorities and private enterprises. The MoWD supplies were Oloitokitok, Kajiado and Machakos. The first two were based on springs and boreholes. Operation and maintenance of these schemes was carried out by MoWD personnel. However, maintenance procedures needed improvements. Poor treatment, water losses due to leakage, unmetered and unrecorded connections were excessive- up to 40% in Kajiado. The Athi river town council was the only town council that had developed its own water supply scheme. The scheme was based on a river intake and a treatment plant providing 1200m³ per day to feed 430 connections. The supply was not enough and therefore private consumers developed their own supply either from the river or private boreholes. Private extraction was estimated at 400m³ per day⁵⁶⁹.

There were approximately 300 boreholes within the project area of which 240 were privately owned. The very scanty data available suggested that private ground water utilisation amounted to about 27,300 litres per day. About 60 percent was abstracted in the Machakos region and the rest in Sultan Hamud, Simba, Kajiado and Athi River areas. Basically private water supply was the major source of water supply in the projects area. Plans for further development were prepared waiting for implementation.

The existing projected livestock water demand was estimated based on existing livestock population and potential rangeland carrying capacity. The Machakos and Kajiado district livestock population was estimated at 75000 stock-units of which 20% were wildlife. The population was expected to increase to 86000 by the year 2012. Approximately 2900m³ per day of water was required and expected to increase to about 3850m³ per day by 2012. However, existing water supply systems were

568 Colony and Protectorate of Kenya (1953 – 1962). Loitokitok Emali pipeline. Kenya National Archives, Ref: PC/NGONG/1/6/32, Nairobi, Kenya.

569 Ministry of Water Development (1988). Nol Turesh Water Project: Quarterly Progress Report-September 1988.

unable to satisfy this demand, the existing supply was unevenly distributed, and where it was enough, overgrazing and improper use of rangeland was experienced⁵⁷⁰.

The proposed Nol Turesh pipeline water project was expected to meet the existing and anticipated livestock water demand, however, it could not satisfy the entire demand while also supplying drinking water to the urban and rural population. It was recommended that despite the implementation of Nol Turesh project, rehabilitation of malfunctioning boreholes and construction of permanent and seasonal reservoirs be put in place in order to reduce the demand for water from Nol Turesh Pipeline⁵⁷¹.

The Nol Turesh area was geographically disadvantaged because of the paucity of water and rugged topography in arid and semi-arid environments. It was predominantly rangeland inhabited by pastoralists (Maasai). There were large spatial variations in rainfall, temperature and potential evaporation in this region. The supply area was underlain by rocks of the Precambrian basement system, mostly undifferentiated gneisses. In Kajiado region and the southern and northern extremes of Oloitokitok, Sultan Hamud, Mashuru corridor, they were covered by tertiary and upper Pliocene volcanic strata, primarily tuffs, phonolites and olivine basalts. Soil cover was varied and intricate, reflecting variations in geology and landforms⁵⁷².

The entire project area was drained by tributaries of the Athi River Basin, although five sub-catchments could be distinguished. Because of the low and unreliable precipitation, most of the rivers were seasonal, and water shortage was a real constraint on the development of rural and urban areas. On land use, in particular, there was no information on land availability for the Nol Turesh pipeline water project. The Gap in the existing data was to be filled by field work conducted by the consultant⁵⁷³.

According to the population data obtained from Central bureau of statistic for censuses of 1948, 1969 and 1979, the growth rates obtained contradicted the national intercensal growth rate estimates of between 2.8-3.9% per annum. The differential growth rates had wide implications in the water demand of the various settlements in the project area⁵⁷⁴.

570 Ministry of Water Development (1988) Nol Turesh Water Project: Quarterly Progress Report-September 1988.

571 Ministry of Water Development (1988) Nol Turesh Water Project: Quarterly Progress Report-September 1988.

572 Ministry of Water Development (1988) Nol Turesh Water Project: Quarterly Progress Report-September 1988.

573 Ministry of Water Development (1988) Nol Turesh Water Project: Quarterly Progress Report-September 1988.

574 Ministry of Water Development (1988) Nol Turesh Water Project: Quarterly Progress Report-September 1988.

The special distribution of human settlements in the project area was guided largely by water availability and the configuration of the communications network, and partly by geomorphological features, climatic variations, agro ecological potentiality and socio-cultural factors⁵⁷⁵.

The water demand: in 1988, 36% of the population had access to piped water supply with some level of treatment, both from individual connections and communal water points. The rest had untreated water drawn mainly from rivers and ponds; this was the main source of water. Water consumption was estimated at about 10 litres per day in households with individual connections. The very low consumption was partly due to relatively low standards of living, the major factor was irregular supply due to frequent system breakdowns.

In households without piped water supply, women fetched water and ferried it on their backs or heads and made three trips per day carrying 33 litres per trip. Approximately 2-4 hours daily was spent fetching water. Based on the existing consumption levels and anticipated growth, projections made indicated an increase by 44000 m³/day from 2700 m³/day-71000 m³/day.

Several alternative schemes were proposed for various parts of the project area and specifically for the three main towns-Athi River, Machakos and Kajiado-which were the main target of the proposed project. In all the previous studies concerning the towns, dam construction had emerged as the favourite alternative. The Munyu dam scheme was expected to offer long term alternative water supply solution for all the three towns. However, this was a long term scheme involving extensive water treatment and pumping⁵⁷⁶. The schemes were:

Athi River Water Supply: In the town, several water sources were identified and alternative solutions were studied in detail. These were development of ground water through a series of boreholes upstream of Athi River Town along Athi and Kitengela Rivers, exploitation of groundwater west of the Kitengela/Athi ridge, and the construction of surface water dams on the upper Athi, Kapio, and Kitengela Rivers at a later stage.

Athi River Meat factory: By 1960, the Athi river meat factory commission had two boreholes supplying the need of the abattoir and a considerable number of houses for senior and medium grade employees. The boreholes produced water with a fluorine content of 10.6 and 11.6 ppm respectively which was so far to the extreme limit recommended by health authorities of 1.5 ppm. The water was

575 Ministry of Water Development (1988). Nol Turesh Water Project: Quarterly Progress Report-September 1988.

576 Ministry of Water Development (1988). Nol Turesh Water Project: Quarterly Progress Report-September 1988.

highly saline. Additional water was obtained from Liebig's dam on the stony Athi River for raising steam in the abattoir. The Health authorities recommended that all the water supply and reticulation system throughout the Athi River factory and Housing was supposed to be expertly examined to ascertain its ability to provide the large quantity of water required for all purposes. Generally more than twenty water points were supposed to be provided in order to conveniently provide about 100, 000 cubic metres per day⁵⁷⁷.

Athi River Detention Camp: The Athi River transit camp by 1953 had 1400 people with adequate water supply from boreholes⁵⁷⁸. The supply was ample but water had to be carried to the top camp because the pressure was insufficient. A new tank of capacity 57m³ was erected in 1956 at a higher level and was expected to rectify the problem⁵⁷⁹.

By 1962, water supply to Athi River prison was found polluted. One of the borehole supplies was polluted by wastewater disposal plant which took the drainage from the slaughterhouse and which was sited within the 100 yards of the borehole. Only one borehole supplied sufficient water for the existing needs of the prison. The health inspector recommended diversion of waste water drains from the borehole and discontinuing the use of the polluted borehole till the time it proved free from contamination⁵⁸⁰

Machakos Water Supply: Machakos Town is the administrative centre of Machakos District in Eastern Province. It lies about 16km off the main Mombasa – Nairobi Road, a total distance of about 67km to the Southeast of Nairobi. Machakos Town lies within a U-shaped ridge of hills comprising the Iveti Hills and Mitaboni plateau to the northeast which rise to about 2,100m above sea level and the Mua Hills which are located several kilometres to the West and Northwest and rise to an altitude of about 2,080m. The altitude at the valley floor in which the town is located is about 1600 metres above sea level⁵⁸¹.

Machakos history dates back in 1917 during the first World war whereby throughout the year 1917 the work of civil administration in the Ukamba Province was overshadowed and greatly affected by the war. In every district, the main attention

577 Burge P.H, (1960). Athi River Abattoir, African Staff Housing. Kenya National Archives, BY/62/6. 30th September 1960.

578 Health Inspector, Machakos District (1953). Athi River Transit Camp Kajiado Road Athi River. Kenya National Archives, BY/6/28. 10th March 1953.

579 Beckingsale W.D. (1956). Athi River: Water Supplies. Kenya National Archives, BY/6/28, Ref: 1/1/7/14/III/11. 4th September 1956.

580 Port Health Inspector, (1962). Water Supply and Drainage, Athi River Prison. Kenya National Archives, BY/6/28, Ref: 2nd February 1962.

581 Samez Consultants (2009). Draft Feasibility Study Report -May 2009. Feasibility Study for Machakos Water Supply and Sanitation Project.

of the staff was directed to the task of complying with military demands for men and material. The performance of ordinary duties was subordinated to this principle. However, in this province the war was not a direct concern of the native except when the administration made it so, the native when asked participated willingly⁵⁸².

By 1918, it was recognized that it was necessary to deplete the reserves of able-bodied men between the age of 18 and 30 years, in order to supply the number for the war. This burden fell on the District Officer and the tribal authority⁵⁸³.

By 1922, the financial depression showed very little improvement. The long rains upon which so much depended was variable and capricious. Although some locations obtained adequate rainfall, Machakos and Kitui Districts did not receive any at all. Efforts were made at Machakos to furnish a supply of water for the township by sinking a well. Even at a depth of 110 ft., the results were unsuccessful⁵⁸⁴. The appointment of Medical Officer to Machakos resulted in the improvement of the sanitary arrangements. The water supply remained unsatisfactory. A survey was made by Hydraulic Engineer in 1921 estimated that the cost of installing a pipeline was computed but the government had no funds to meet the expense. At the same time the public works department appeared unwilling to leave the matter to private enterprise⁵⁸⁵.

By 1926, the condition of the water supply for Machakos required great urgent address. Only little water that was not pure was available. The officers were dependent for their water supply needs on tanks and a well which held extremely hard water. It was estimated that inhabitants paid a water rate which could bring approximately 355 pounds per annum. This fact was presented to the Public Works Department, which downplayed the progress of the issue. The Hospital at Machakos was purely dependent on the rain water⁵⁸⁶.

The water supply in Machakos in 1927, involved carrying out a detailed survey of the Iveti water supply scheme. As a result, money for the installation was included in the estimates in 1928. Major Saidler carried out the survey⁵⁸⁷.

582 Acting Provincial Commissioner (1917). Report by Ag Provincial Commissioner for the Twelve Months Ending 31st March 1917. Kenya National Archives. PC/CP/4/2/2 April 1917.

583 Acting Provincial Commissioner (1918). Report by Ag Provincial Commissioner for the Twelve Months Ending 31st March 1918. Kenya National Archives. PC/CP/4/2/2 April 1918.

584 Senior Commissioner (1922). Report by Senior Commissioner for the Nine Months Ending December, 31st, 1922. Kenya National Archives. PC/CP/4/2/2, 1922.

585 Senior Commissioner (1922). Report by the Senior Commissioner for the Nine Months Ending December 31st 1921. Kenya National Archives. PC/CP/4/2/2 1922

586 Acting Senior Commissioner (1927). Ukamba Province Annual Report 1926, Kenya National Archives, PC/CP/4/2/3 1927.

587 Campbell W. F G (1927). Ukamba Province Annual Report 1927. Kenya National Archives, PC/CP/4/2/3. 1927.

By 1928, few dams had stood up well but there were failures. The failures were positive because the natives learnt from them that dam building exercise was not a “child’s play” as the senior commissioner observed. A case in point was where dam collapsed and the natives built it by themselves and without supervisions. Dam building work continued in 1928 with an objective to let every sub-location to have its dam. The provincial administration was responsible for the supervision and construction of dam exercise⁵⁸⁸.

The District Commissioner reported that the chief event in Machakos Township during 1928 was the installation of a water supply. The water supply was piped from Iveti hills by the Public Works Departments and was availed to the public. By the end of the year, there were 14 applications for supply received from members of the public. These with fees collected from the government servants and departments was sufficient to pay for the interest and sinking fund charges. As water was a difficult perennial problem in Machakos, the installation was considered a great boom upon the town⁵⁸⁹.

Considerable progress was made with construction of dams in 1928. Three were built at Kiasu, one at Masii and another in upper Mbooni. Two at Kilungu and one at Kalome and one in lower Mbooni were enlarged. The natives at last saw how useful a dam was and the former opposition was withdrawn. Although rain destroyed the dams, repairs were accordingly done. By the end of 1928, 43 water connections had been made. During December, fencing of the catchments area commenced to prevent any contamination of water⁵⁹⁰.

In 1930, eight dams were constructed in Machakos reserve; several others were repaired or added to. A total of 30 dams were realized. The district commissioner reported that the natives by this time appreciated their usefulness and made applications themselves for construction⁵⁹¹.

A water boring machine was engaged by the Kitui Council and arrived in September, after an adventurous journey. Forty oxen were bought by the council to transport it from Thika. However, the manpower was necessary when it reached the rocky hills in the Kitui reserves. It sunk a borehole at Kiomo to a depth of 300 ft. where water located was not sufficient in quantities to be of any use. The trouble involved in moving the machine that weighed 8 tons and its apparent lack

588 Senior Commissioner (1928). Annual Report, Ukamba Province, 1928. Kenya National Archives, PC/CP/4/2/3. 1928.

589 Senior Commissioner (1928). Annual Report, Ukamba Province, 1928. Kenya National Archives, PC/CP/4/2/3. 1928.

590 Senior Commissioner (1929). Ukamba Province, Annual Report 1929. Kenya National Archives, PC/CP/4/2/3. 1929.

591 Provincial Commissioner (1930). Ukamba Province, Annual Report 1930. Kenya National Archives, PC/CP/4/2/3. 1930.

of success discouraged the Akamba who decided not carry on⁵⁹². The water supply was extended to the Veterinary Quarantine Station, the Ukamba Native School and the Slaughtering House⁵⁹³.

In 1929, the Government put in the first Machakos water supply at a cost of 2,427 pounds. It was a simple gravity feed supply and its working costs were low. The supply emanated from a forest area in the reserve and was piped through a native reserve to Machakos Township. Since its inauguration, it operated as a commercial venture accruing a profit for the Government. In 1935, the profit accrued from the water supply was 365 pounds apart from renewals fund and operation and maintenance having been met⁵⁹⁴.

Since the Machakos water supply was put in as a Government venture to supply water to the township as a matter of administrative convenience and for commercial purposes its ownership was vested in the Government. However, the operation and maintenance of the water supply was undertaken by the Machakos Local Native Council, which then remitted, the profits accrued to the government as revenue⁵⁹⁵.

In light of the above, the then District Commissioner Mr Marchant, suggested that, since the Local Native Council (LNC) was regarded as the local governing body it should take over the ownership of the water supply and any profits accruing would be credited to councils funds. He also suggested that, later when a Municipal council is been formed, the control and management of the supply could be vested in the municipal council. The council would then be expected to reimburse the government the cost of installation⁵⁹⁶.

Mr. Marchant's suggestion met very strong opposition from the Colonial Secretary Mr. Bader and the Treasurer, Mr. Walsh argued that it would amount to loss of recurrent revenue to the colony. However, the main borne of contention was the issue of whether a water supply operating in a township situated in a native reserve should as a matter of principle be operated by the Local Native Council or by the Government. The fear was that letting the Local Native Council own the water supply would be tantamount to pronouncing it as the 'Township Authority' and would lead to further claims⁵⁹⁷.

592 Provincial Commissioner (1930). Ukamba Province, Annual Report 1930. Kenya National Archives, PC/CP/4/2/3. 1930.

593 Provincial Commissioner (1930). Ukamba Province, Annual Report 1930. Kenya National Archives, PC/CP/4/2/3. 1930.

594 Marchant W.S (1935). Machakos Water Supply. Kenya National Archives, BN/9/28, Ref: No. 728/PW/8/6, 20th April 1935.

595 Marchant W.S (1935). Machakos Water Supply. Kenya National Archives, BN/9/28, Ref: No. 728/PW/8/6, 20th April 1935.

596 Marchant W.S (1935). Machakos Water Supply. Kenya National Archives, BN/9/28, Ref: No. 728/PW/8/6, 20th April 1935.

597 Bader P.E (1935). Machakos Township Water Supply. Kenya National Archives, BN/9/28, Ref: WAT.8/5/1/73, 8th June 1935.

The Local Native Council was to confine themselves to the matters in their reserves and not assume full responsibility in respect of townships where the local seat of the government was centred. This was because they were considered as to be neither equipped nor qualified for such matters⁵⁹⁸.

It is clear from the above argument that the European did not wish his administrative supremacy to be challenged even in respect of such basic services as water supply. All the argument is centred on the fear of a Local Native Council developing into an 'Authority' and not their ability to run the water supply, this notwithstanding that they had controlled and managed the water supply for the government and that it had actually accrued profits which formed revenue for the colony.

Setting in of water problems: Machakos water supply operated well until 1941 by which time the first borehole for Machakos Township had already been put in. This was when the springs from which water was derived started to dry. The springs actually dried up and the greater pumping from the borehole had to be executed to meet the needs of the township.⁵⁹⁹ A second borehole was also proposed and built by 1944. In 1944 the consumption was however so high the pumping hours from the two boreholes was 16 to 18 hours a day and could still not meet the demand. A critical situation had been reached⁶⁰⁰.

As a result, a third borehole was proposed while at the same time a new tank was to be built so that in case of breakdown there could be sufficient supply to the township as repairs were instituted. Further a larger pump was to be installed to the second borehole so as to increase pumping to the maximum safe yield. To accommodate the higher pumping rate, the rising main was to be replaced with a pipe of higher diameter⁶⁰¹.

The above proposals were not carried out and in 1946 the situation on water supply was getting even worse. However, despite the imposition of a certain measure of rationing of the water supply as from the 1st March 1946, the average consumption in the township for the first six months of 1946 year exceeded the averaged consumption for 1945 by 10%, 1944 by 19.5%, and that of 1943 by 52%.

Machakos water supply augmentation: A sum of 380 pounds was requested from the colonial government to take care of the cost of pumps of larger capacity,

598 Bader P.E (1935). Machakos Township Water Supply. Kenya National Archives, BN/9/28, Ref: WAT.8/5/1/73, 8th June 1935.

599 Stronach J.C (1941). Machakos Water Supply, Operating expenses. Kenya National Archives, BN/9/28, Ref: WAT.36/28, 3rd October 1941.

600 Collins J.W (1944). Machakos Water Supply, Standby Borehole. Kenya National Archives, BN/9/28, 29th November 1944.

601 Collins J.W (1944). Machakos Water Supply, Standby Borehole. Kenya National Archives, BN/9/28, 29th November 1944.

extensions to the treatment plant and alteration to the rising main as an interim measure to ease the problem. Machakos Township seems to have grappled with the question of a proper water supply until 1957 when a new water scheme to supply water from a dam on the Maruba River (figure 3.27) was hatched.



Figure 3.27: Maruba Dam site in 1983⁶⁰².

Several sites for a building of a dam near Machakos Township were investigated including sites on the Maruba and Murogoni Rivers. Investigation into possible dam sites did not prove to be fruitful and even prospect of ground water were considered. The hydraulic engineer, Mr. Squires considered that the ground water possibilities of Machakos Township were by from a number of scattered sites and was expensive. By then the daily consumption as at 1957 had reached 341 m³ per day, while the maximum capacity of the boreholes was 364 cubic metres. He envisaged that the pumps were running virtually for 24 hours and that without rationing - both planned and incidental – the consumption would have been well over 455 m³ per day.

After several considerations the Hydraulic engineer settled on a suitable dam site on the Maruba River. The capacity of the dam was to be 13,638 litres. The annual flow of the river was at 2.6 million cubic metres. It was calculated that the daily draw-off would be 3182 m³ and the system would be adequate to serve the township for 15 to 20 years.

602 Hunn G (1983). Progress Report About water Projects included in the Minor Urban Water Supply Programme. NORAD –Coordinator/MOWD. Nairobi Ref: WD/1/2/5. 10th June 1983.

The augmentation of Machakos water supply received an impetus to its development in form of the upcoming of a large teacher training college which by 1957 was under construction and the anticipated 200 students and staff required ample water supply for the operation of the college. In spite of the grievances raised by the PS Ministry of education the project did not take off. A different arrangement was however made to ameliorate the situation. Two new pumps were bought so as to pump more water from the boreholes, whose yield was estimated again by the hydraulic engineer to be 546 litres per day against a total consumption including that of the anticipated college of about 455 litres per day. The supply was to be raised to 482 litres per day by buying of the new pumps.

This temporary solution to the water problem, worked, but the start of construction of the dam was delayed until 1959/60 when the construction began. The earth embankment contained nearly a million a quarter of a million tons of compacted earth and hand laid stone, and about 30,000 tons of rock had to be blasted when making the spillway excavation.

During construction in April 1960, some severe flash flood occurred in the river, and it was estimated that the peak flood flowed at a rate of one million gallons per day for a short period. Fortunately the dam was sufficiently far advanced for the basin to absorb the worst of the floods, and the balance of the flow was passed down a by-pass channel specially made to deal with such a contingency. The dam embankment was made of uniformly consolidated earth, with a heavy rock 'toe' and the spillway designed to pass a flood of up to 3,000 million gallons per day. The dam basin capacity was 350 million gallons and the length of the embankment was 750 m long. Its height was 64 ft. while the water depth was 54ft.

The water treatment facility and pumping installation was designed to cater for a consumption of 200,000 gallons per day in the first instance, and to be expanded simply to deal with 400,000 and then 600,000 gallons per day as the water consumption increased. The works provided for coagulation, sedimentation, filtration and sterilisation of the raw water.

The water supply was put up at a cost of 140,000 pounds and although the initial outlay was high it was expected that the venture would be profitable in lieu of the anticipated water tariff which was expected to be adequate to provide for O&M, interest on capital and redemption of capital outlay by the time the works life expired. The supply was opened on 22nd may 1961 by the then Minister for Agriculture and Animal Husbandry, Mr. B.R. Mackenzie.

By 1983, existing water department gazetted water supply abstracted from Maruba dam which was constructed in 1958-61. The design capacity of the dam

was 1.4million litres but reduced to 1.0 million litres due to silting. It was considered completely inadequate for the growing population. By 1983, the municipality covered an area of 320km² and the urban centre was a small proportion of this A population and demand projection for Maruba is illustrated in Table 3.30 shows a demand for 27147m³ by the year 2008⁶⁰³.

Table 3.30: Population and demand projections for Maruba dam water supply system between 1982 and 2008.

Year	1982	1992	2008
Population urban	30,866	63,616	131,114
Population rural	98,192	129,339	166,777
Total population	129,058	192,955	297,891
Urban demand (m ³ per day)	4,108	7,985	16,147
Rural demand (m ³ per day)	5,742	7,753	10,676
Total demand (m³ per day)	9,850	15,738	27,147

By 1983, the Machakos water supply completely grew out of proportion as compared to the original estimates of KES 0.7 million in 1973 and revised estimates of KES 2.26 million in 1977 to KES 480 million and the MoWD had approved KES 200 million for the purpose of fee circulations. The enormous increase was due to two dams which had to be constructed to cover the increased demand.

Treatment and reticulation was estimated at KES 12 million. The supply was expected to cover 320km². The World Bank offered assistance to the urban water supply programme and it proposed that the bank (IBRD) finance the Machakos water supply. NORAD could not finance such an enormous scheme and Machakos water supply was therefore not to be included in a new MUWS agreement for the period 1984-1988.

In 2005, Surface water resources in Machakos Town and the surrounding area consisted of seasonal streams and rivers as well as dams. The major rivers within the municipality were in the East of Machakos Town and Rivers Maruba, Miwongoni and Mitheu which joined to the Kiima Kimwe to form Mwanian River. River Mwanian was joined in its course by tributaries from Kiima Kimwe to its North and Kimutwa to the South and became Ikiwe River. Ikiwe River eventually joined River Thwake⁶⁰⁴.

603 Hunn G (1983). Progress Report About water Projects included in the Minor Urban Water Supply Programme. NORAD –Coordinator/MOWD. Nairobi Ref: WD/1/2/5. 10th June 1983.

604 Samez Consultants (2009). Draft Feasibility Study Report -May 2009. Feasibility Study for Machakos Water Supply and Sanitation Project

There were a number of dams in the Municipality, the biggest of which was Maruba Dam that supplied water to Machakos Town. Several springs arose from the Iveti Hills and were tapped to supply water mainly to the eastern parts of the Municipality. Groundwater flow in the Mackakos Municipality drained from the higher altitude areas. A water table occurred between the fractured/weathered contacts of the Basement System rock formations⁶⁰⁵.

Most of the groundwater was found along dry river beds such as the five boreholes that were located to the northwest of Machakos Town alongside the seasonal Iini River and many other boreholes drilled in the locality.

Groundwater in Machakos Municipality was exploited and a number of boreholes were sunk, both for individual and municipal water supply. A total of 57 boreholes were drilled from 1938 with varying yields; some were found dry while others (in Katheka-kai) had high yields of up to 20.7 m³ per hour⁶⁰⁶.

Kitui Water Supply: Kitui town is situated approximately 140km east of Nairobi in eastern province and by 1983 was the divisional headquarters for Kitui District. The population within Kitui town was approximately 9000 by 1983 and approximately 30,000 by the year 2000. The location of Kitui water supply is illustrated in figure 3.28.

605 Samez Consultants (2009). Draft Feasibility Study Report -May 2009. Feasibility Study for Machakos Water Supply and Sanitation Project.

606 Samez Consultants (2009). Draft Feasibility Study Report -May 2009. Feasibility Study for Machakos Water Supply and Sanitation Project.

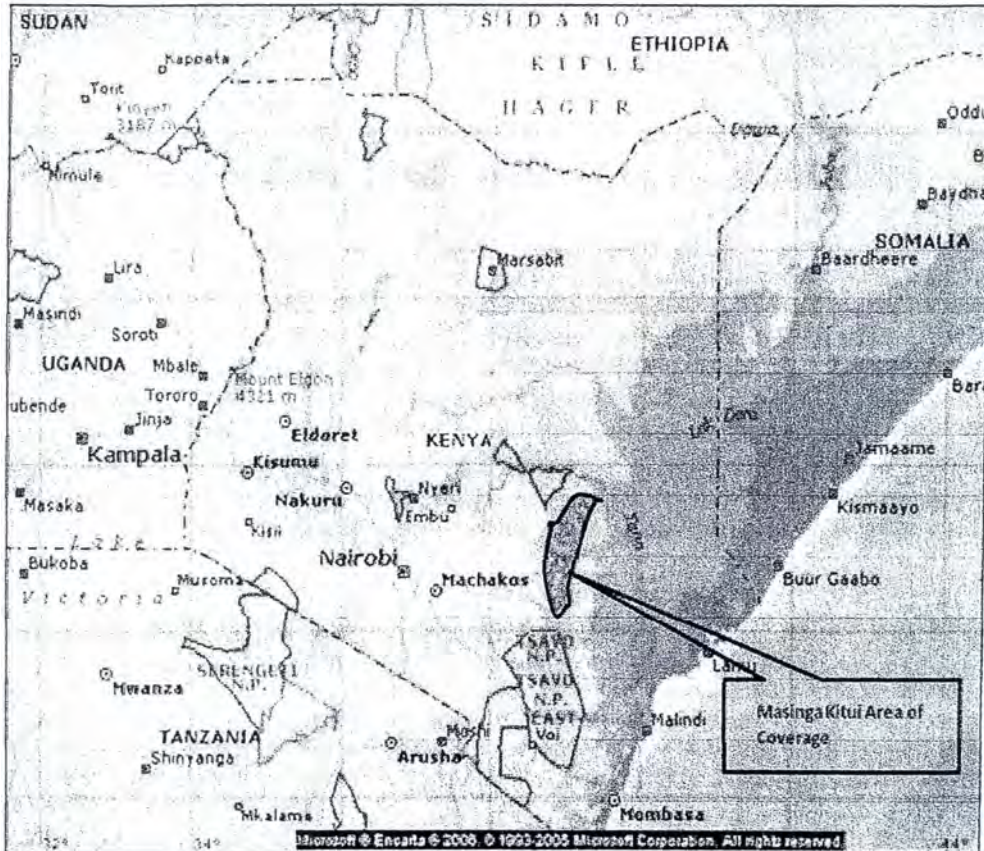

Figure 3.28: Water coverage area of Masinga Kitui water supply area of coverage in 1979⁶⁰⁷

By 1913, The Kitui Township consisted of, Swahili village, Detention camp, Askari lines, station hands, the African school, tempo shop, native hospital, the Asians and European staff quarters, African and Asian staff quarters and the slaughter houses/ butchery. In all areas sanitation works had to be maintained. The issue of Kalundu River pollution was considered and it was recommended that the Township Rule regulating washing and bathing to be enforced. This would eventually reduce the pollution of the supply⁶⁰⁸.

By 1915, the Kitui Township had running water from the Kalundu and Nzeo River on western side and eastern side respectively. It contained government build-

607 Director of Water Department and East Africa Engineering Consultants (1979). Kitui Urban and Rural Water Supply Project: Kitui Water Supply Appraisal of Future Development Options, Including Phase 1 Final Design Report. Volume 1. Ministry of Water Development. Nairobi.

608 District Commissioner, Kitui (1913). Report on Kitui District for the Year Ending 31st March 1913. Kenya National Archives, DC/KTI/1/1/1. 1913.

ings, Indian bazaar and Swahili location. The prisoners were employed principally in the prison shamba but did all sorts of work in the station besides such as making drains, clearing and stumping bush, they also drew water during the dry seasons⁶⁰⁹. As early as 1930, efforts to provide water supply for Kitui were ongoing⁶¹⁰.

By 1935 Kitui water supply had been proposed. The Provincial Commissioner, Central Province, M. R.R. Vidal, on May 10th 1935 while addressing the Colonial Secretary on this water supply noted as follows;

“For years past, the need for a proper supply has been urged by every Administrative Officer who has been stationed at or has visited Kitui, both on the grounds of health of the inhabitants and of the very heavy yearly expense to Government for the present most unsatisfactory system of supply of putrid water to the official inhabitants by means of ox cart”.

The fact that the stream, from which it is proposed to provide the supply, has been dry for three months is not altogether surprising after two or more years of drought and it is reasonable to suppose that such a happening will not occur again for a period of years, if past history is taken into account.

Recharge of groundwater sources, sub-surface reservoirs and surface impoundments⁶¹¹.

Kalundu River flowed north to south direction and a section of its length formed the northwest boundary of Kitui Township. The river valley had a flat gradient and although large amounts of water flowed during the rains, the velocity allowed disposition of fine silt in the upper reaches. Flows in the river were seasonal. It was not considered feasible to construct a further dam downstream of the existing Kalundu dam.

Mutendea River rose in the Kitui Hills and flowed generally westwards and passed within 1.5 km west of Syongila Market. It joined the Tiva River at Ngoleni. No gauging stations were established on this river and no detailed hydrological information was available. The river bed was deeply cut into the strata and it was feasible to establish series of sub-surface dams on the river⁶¹².

609 District Commissioner, Kitui (1915). Annual Report 1914-15. Kenya National Archives, DC/KTI/1/1/1 Ref 230/15/15. 7th May, 1915.

610 Provincial Commissioner (1930). Ukamba Province, Annual Report 1930. Kenya National Archives, PC/CP/4/2/3. 1930.

611 Republic of Kenya (1979). Kitui Urban and Rural Water Supply Project: Kitui Water Supply Appraisal of Future Development Options Volume I, Including Phase I Final Design Report. Ministry of Water Development. December 1979.

612 Republic of Kenya (1979). Kitui Urban and Rural Water Supply Project: Kitui Water Supply Appraisal of Future Development Options Volume I, Including Phase I Final Design Report. Ministry of Water Development. December 1979.

Ngomi River rose from Kitui Hills south of Kitimi and was a major tributary of the Mutendea River. It flowed approximately 0.5km to the west of Mutuni. One quite successful sub-surface dam was constructed near Mutuni Mission and supplied water to the mission, market and school. The existing capacity of the dam was insufficient to meet the full demand.

Kaayo River was a small tributary of the Tiva River. The confluence of this river with the Mutendea River was the beginning of Tiva River at a point two Kilometre south east of Kathioro. This river had a number of favourable sub-surface dam sites⁶¹³.

Tiva River the headwaters of this Tiva River, which rose in Kitui Hills and flowed within 10km to the west of Kitui Township, remained largely underdeveloped as a source of water supply. The total catchment of the river was considerable, covering approximately thirty square kilometres. However, there were little vegetation cover in the area and grazing and cultivation resulted I high run-offs and several flash floods. Erosion within the catchment was extensive⁶¹⁴.

The Yatta Canal was completed in 1959 and prior to its completion and agreement was reached between the government and the people of Kitui and Machakos districts that 5 Cusecs of normal, (dry weather) flow was to be always released to River Tana –Tiva watersheds to pass into Mwitwa Syano River, which formed the Kitui district boundary. The people of Kitui were supposed to contribute to the maintenance of the canal by annual payment. The canal was built with a total capacity of 2,270cusecs. It was designed to operate efficiently at a constant flow of 1.135 cusecs and this was the quantity sanctioned in the future in the view of the requirement of the under construction by 1977. The intention was to release this quantity into the Mathengauta valley which started just above the bifurcation point at Matuu, in order to fill a series of a dam⁶¹⁵.

Surface impoundment dam

The first proposal was to construct a surface impoundment dam in the hills to the North of Kitui Township and its environs. The major difficulty with this was the proving of the catchment for phase one supply for Kitui, a supply required as matter of urgency. This was primarily the reason for establishing the Yatta Canal as the source of phase one supply.

613 Republic of Kenya (1979). Kitui Urban & Rural Water Supply Project: Kitui Water Supply Appraisal of Future Development Options, Including Phase 1 Final Design Report. Volume 3. Ministry of Water Development. December 1979.

614 Republic of Kenya (1979). Kitui Urban and Rural Water Supply Project: Kitui Water Supply Appraisal of Future Development Options Volume I, Including Phase I Final Design Report. Ministry of Water Development. December 1979.

615 Republic of Kenya (1979). Kitui Urban and Rural Water Supply Project: Kitui Water Supply Appraisal of Future Development Options Volume I, Including Phase I Final Design Report. Ministry of Water Development. December 1979.

Kabonge Valley was situated some 4km to the northeast of Kitui Township. It was a good site for dam as confirmed from preliminary site investigations. However, pumping was necessary. Since the area was well cultivated it was only considered for long-term development to argument the existing supplies.

Kitimui Valley was considered the primary site for establishing a surface impoundment dam to provide a further phase of water supply to Kitui. The valley was situated approximately 16km to north of Kitui in Kitui Hills adjacent to Kitimui Hill and through which flowed of Ndiang'u River. However, there were no flow records for this tributary which was generally seasonal⁶¹⁶.

Because of the urgency to provide Kitui with a water supply, and as there appeared to be a need to prove the catchment of the dam proposed in the original preliminary design report, the Ministry of Water Development instructed that the phase one source for Kitui was from the Yatta Canal. A route selected for the supply main was aid between Matuu and Kitui⁶¹⁷.

Population and demand

Phase one was supposed to include the population and commercial developments of Kitui, Matinyani, Mutuni and the rural and livestock population to the year 1988. Only the population within the 12 km strip each side of the trunk main was considered.

Matuu water supply: In 1979 the Ministry of Water Development and East African Engineering consultants agreed that a water supply be made for Matuu. Consequently a 150mm³ diameter raising main was laid from the treatment works pumping station to the 300m capacity elevated water tower sited in Matuu. The elevated water tower was constructed in reinforced concrete and was located adjacent to catholic church and allowed for approximately 16 hours storage. From the tower, water was passed through a meter into Matuu supply distribution mains. It was found necessary to supplement and reinforce the existing reticulation. The demand for water was estimated at 4,180m³/day and a pipe diameter of 400mm was determined as being required to enable sufficient head to be retained n the main to negotiate the high points along the route⁶¹⁸. Kitui urban and rural water supply networks is illustrated in figure 3.29.

616 Republic of Kenya (1979). Kitui Urban and Rural Water Supply Project: Kitui Water Supply Appraisal of Future Development Options Volume I, Including Phase I Final Design Report. Ministry of Water Development. December 1979.

617 Republic of Kenya (1979). Kitui Urban & Rural Water Supply Project: Kitui Water Supply Appraisal of Future Development Options, Including Phase 1 Final Design Report. Volume 3. Ministry of Water Development. December 1979.

618 Republic of Kenya (1979). Kitui Urban & Rural Water Supply Project: Kitui Water Supply Appraisal of Future Development Options, Including Phase 1 Final Design Report. Volume 3. Ministry of Water Development. December 1979.

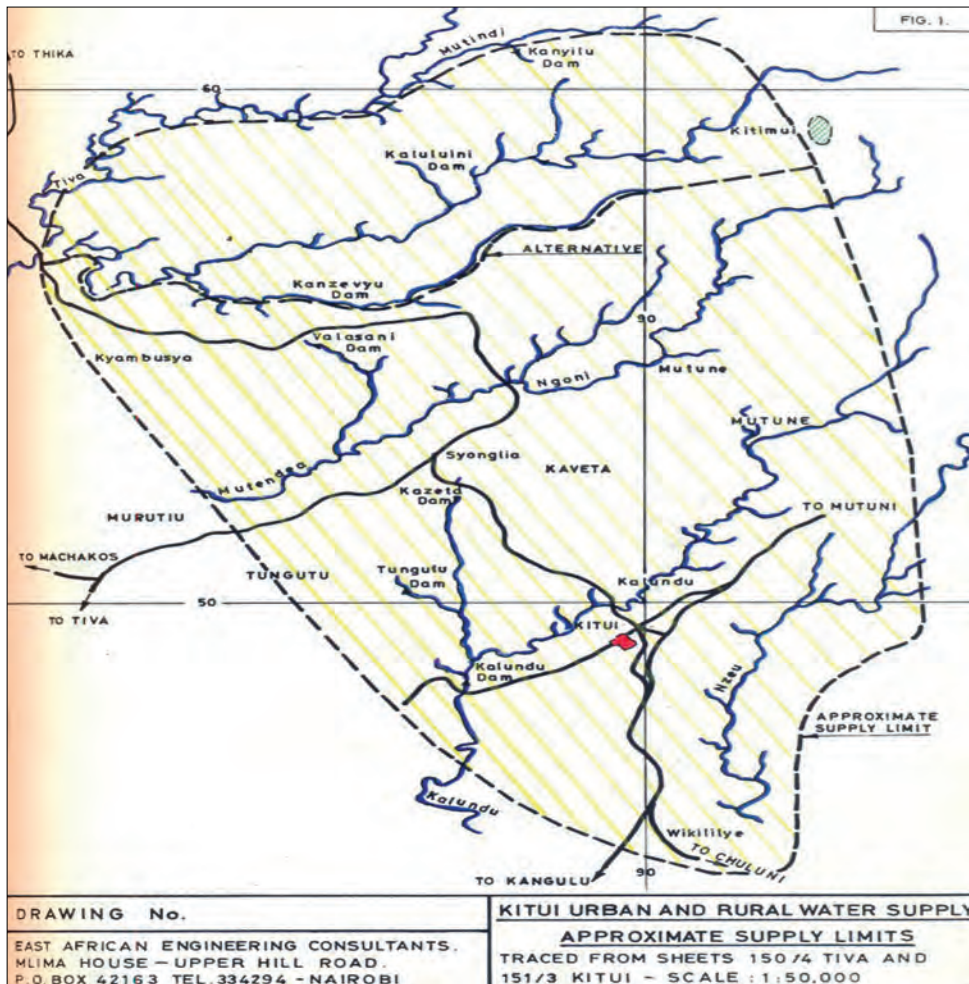

Figure 3.29: Kitui urban and rural water supply networks⁶¹⁹

Before 1935, calls for the supply had been amplified and a scheme prepared utilizing water from a stream that at this particular time was dry, raising fears of its reliability and leading to shelving a scheme that would have cost £1800. This was ostensibly to look for further funding for adequate storage facilities. The mode of conveyance to Government Officials was by unhealthy and expensive ox cart⁶²⁰.

Rainwater tanks also formed a substantial source of supply for the township. In addition, the wind mill supply served the hospital. The windmill pumping was from

619 Director of Water Department and East Africa Engineering Consultants (1979). Kitui Urban and Rural Water Supply Project: Kitui Water Supply Appraisal of Future Development Options, Including Phase 1 Final Design Report. Volume 1. Ministry of Water Development. Nairobi.

620 Colony and Protectorate (1934-1960). Medical Department. Kitui Water Supply, BY/35/7.

an existing well that was sunk in a 'donga' and the water stored in a cement tank of capacity 45.5 m³. During dry weather, the flow would be as low as 546 litres/day in which time augmentation was by cart from the Kalundu River.

By August 1939, the water supply had been commissioned and served Kitui Town and the hospital. The source of supply to this scheme was a spring (Mbooni) and a borehole whose date of construction was unknown as well but would have been commissioned abreast the spring. No further proposal to maintain the wind mill supply to the hospital was mentioned and the windmill was expected to be removed. By 1940 the pumping equipment had started having breakdowns and the Director, PWD recommended provision of a standby plant⁶²¹.

Till 1949, the inadequacy of the supply seemed to persist. The MOH Kitui writing to the DC on 13th October 1949 complained that the hospital's supply was less than one hour per day and he attributed this to four reasons:

- Lack of storage tanks
- Large quantity of water used by school and BAT
- Drawing off from rising mains
- The continuous breakdown being experienced with the engines

In the 1950 financial estimates, the Divisional Engineer undertook the following augmentation works:

- Fitting 455 litre storage tanks in the roofs of the Government European Bungalows
- Throttling diaphragms fitted to connections of the five heaviest consumers off the rising main
- Thorough inspection and patrolling of rising main
- Cleaning of high level storage tank to remove sediment

In 1958, a dam was designed across the Kalundu River for this supply. The surface area of the reservoir at full supply level was twelve acres. The treatment was to be through coagulation, filtration and chlorination before pumping into the township mains. There, however, were health concerns over malaria and bilharzias increment. To overcome this health concerns, it was recommended to put a hedge around the dam to prevent the ingress of human or cattle and to employ overseers of the dam to trim and maintain salubrious conditions around the dam.

621 Colony and Protectorate (1934-1960). Medical Department, Kitui Water Supply, BY/35/7.

The dam had been constructed and commissioned before 1960 and samples of water taken from this dam in 1960 on suspicion of causing ill health were found to be 'a very serious threat to the health of the users' in the words of the District Commissioner on a bacteriological examination carried out by the Medical Officer of Health⁶²².

In 1979, thirteen supply points were identified along the route of the mains where there were accumulations of population. At each of these points and depending upon the assessed demand, a small storage tank was erected from which the villagers took supplies of water. They were encouraged to develop their own local distribution piping on a 'Harambee' basis, with assistance from the ministry in regard to pipe-laying and expertise only. Communal water points and water kiosks and water Kiosks were supplied from those supply tanks. No supplies were taken directly from the mains⁶²³.

By 1983, the dam was badly silted up and the total capacity was completely insufficient to cover the peak demand by 1983. The boreholes with 4500 m³ per yield were day were to be incorporated in the 1983 scheme.

The original proposal in 1973 was to augment the existing scheme for an ultimate population of 17000. The 1983 proposals were designed by East African engineering Consultant and presented several proposals: supply be sourced from Syana River 40km west northwest of the township a proposal which was rejected due to lack of sufficient flow data. The second proposals proposed construction of sub-surface dams on the Tiva River, 15km north northwest of Kitui Town. The solution chosen was to supply piped water from Yatta canal at Matuu 60km to Kitui. The water was to be treated at Matuu and supplied by gravity to Kitui through twin uPVC pipes with dimensions of 2 by 300mm and 2 by 250mm. These lines had a limited capacity to supply up to 1990. Matuu centre and the areas along the pipeline were included and the ultimate population was increased to 70000 persons. The revised cost estimate for completing the scheme was by 1983, KES 140 million as compared to the original KES 19 million⁶²⁴.

The cost increase was ridiculously high. The actual implementation cost as per December 1973, including design, supervision price increases etc. was estimated at KES 70 million. The total price increase was therefore 1731% while the increase in population was less than 100%. It was difficult for NORAD to accept funding

622 Colony and Protectorate (1934-1960). Medical Department, Kitui Water Supply, BY/35/7.

623 Republic of Kenya (1979). Kitui Urban & Rural Water Supply Project: Kitui Water Supply Appraisal of Future Development Options, Including Phase 1 Final Design Report. Volume 3. Ministry of Water Development. December 1979.

624 Hunn G (1983). Progress Report About water Projects included in the Minor Urban Water Supply Programme. NORAD –Coordinator/MOWD. Nairobi Ref: WD/1/2/5. 10th June 1983.

half of the inflated projects since had agreed to give assistance for implementing 40 water schemes and 7 sewerage schemes by 1973. In 1981, the contractor (CEB) stopped after doing minor works in between 1981 March and June; no official final decision about termination of contract was declared since. The percentage of work done by then was 13 percent⁶²⁵.

By 1983, NORAD had contributed financially to greater work load than originally intended. Forty-one projects had not been completed within the ten-year period and all these projects had increased in size, complexity and cost⁶²⁶.

A total amount of KES 65.5 million had been spent by 1983 for Kitui water supply and estimated final cost was approximately KES 140 million assuming that the original proposal was implemented.

Some of the challenges affecting the water supply were the yearly two weeks closure of Yatta canal for cleaning purposes and there was a sharp increase in prices and thereby increasing the cost of projects by millions of shillings. Kitui water supply was probably the least successful of the 49 projects included in the MUWS due to complicated design chosen, high construction cost and the problems encountered during phase C construction⁶²⁷.

Mutomo Water Supply: Mutomo was in the southern Division of Kitui district, 69 kilometres from Kitui Township. Development works in the area started in 1957 with proposals to draw water for river Tiva to Mutomo substation through a pipeline. However due to financial constraints this did not work. The African Land Development Executive Engineer, Mr. Classen, investigated alternative sources from the rock catchments with a capacity of 9092 m³ to 13638 m³ whose works commenced in March 1958. Another scheme on pumping and piping started in January 1959 but continued with lesser commitment to 1960s. The District Commissioner, in coordination with the African Land development and the African District Council departments and the Ministry of African affairs conducted the work⁶²⁸.

Mutomo Rock catchments: The rock catchments lay about one kilometre from Mutomo ridge in the direction of the Ithumba River and about one kilometre from the substation. Mr. Classen, the District assistant and the area chief investigated the possibilities of some rock catchments. After several visits, reports and alterna-

625 Hunn G (1983). Progress Report About water Projects included in the Minor Urban Water Supply Programme. NORAD –Coordinator/MOWD. Nairobi Ref: WD/1/2/5. 10th June 1983.

626 Hunn G (1983). Progress Report about Water Projects included in the Minor Urban Water Supply Programme. Ministry of Water Development. Nairobi.

627 Hunn G (1983). Progress Report About water Projects included in the Minor Urban Water Supply Programme. NORAD –Coordinator/MOWD. Nairobi Ref: WD/1/2/5. 10th June 1983.

628 Classen G.A (1957). Mutomo Water Supply. Kenya National Archives, PC/EST/1/4, Ref: IAS/1/21/A/11/39. 15th June 1957.

tive schemes, it was decided that the substation supply would consist of: a rock catchment dam of masonry with an estimated capacity of 9092 m³ to 13638 m³ a pump house with a pump and engine and a gravitational piping to the tank in the substation area⁶²⁹.

Classen established that the daily requirement of water for substation was 22.7 m³. The total cost of constructing the rock catchment dam was estimated at KES 100,000 under assumption that Africans would undertake the construction work on communal basis. The Kitui DC justified communal labour by the virtue of Africans using the water after the completion of the dam⁶³⁰.

The supply was gazetted as a public supply, supplying the trading centre as well as the substation. The estimated revenue for the first one year was KES 2160 per annum arising within two years to about KES 7200 based on water rate of KES 4 per 4.5 m³. The scheme took off in May 1958 after the approval of chief hydraulic engineer⁶³¹.

Rock catchments were the major supplies with some capable of storing between 9092 m³ two to 13638 m³. The total requirement for water in the substation by 1957 was 22.8m³ per day⁶³².

Three proposals were made in 1957 for a pipeline supply, these were⁶³³:

- To pump 20,000 gallons per day from Tiva to Mutomo at a cost of 18,325 pounds.
- To pump 20,000 gallons per day from Tiva to a storage tank halfway between the Tiva and Mutomo and to pump 10,000 gallons to Mutomo at a cost of 18,325 pounds.
- To pump 20,000 gallons from the proposed dam at Ithumba to storage tanks at Mutomo at a cost of 7,110 pounds, excluding labour and transport.

However, the government could only give out KES 80,000 towards the supply and the ALDEV (African Land Development) was not able to produce KES 360,000 by grant and loan as anticipated⁶³⁴. The proposal to pump water from Tiva River

629 Classen G. A (1957). Mutomo Water Supply. Kenya National Archives, PC/EST/1/4, Ref: IAS/1/21/A/11/39. 15th June 1957.

630 District Commissioner, Kitui (1957). Mutomo Water Supply. Kenya National Archives, PC/EST/1/4, Ref: PW.8/5/17/6. 12th February 1957.

631 Classen G.A, (1958). Kitui District Water Supplies-Mutomo Scheme. Kenya National Archives, PC/EST/1/4, Ref: IAS/A/1/21/111/49. 13th June 1958.

632 Classen G.A (1957). Kitui District- water Supplies, Mutomo Dam. Kenya National Archives, PC/EST/1/4, Ref: IAS/1/21/A/11/96. 29th October 1957.

633 District Commissioner, Kitui (1957). Mutomo Water Supply. Kenya National Archives, PC/EST/1/4, Ref: PW.8/5/17/6. 12th February 1957.

634 DC, Kitui (1957). Mutomo Water Supply. Kenya National Archives, PC/EST/1/4, Ref: PW.8/5/17/6. 8th November 1957.

had to be dropped. Three alternatives were sought: first was to pump 91m³ from the Ithumba dam, second; to explore the possibilities of a rock catchment dam at the substation site, third; was a combination of the second with the underground storage of rain water from the roofs etc.

The first alternative of withdrawing water from Ithumba dam was embraced. Classen suggested two designs for a pipeline, one to serve the substation and nothing else, which was to be a direct charge to the central government and the other pipeline to serve the substation but with an additional capacity to serve for a grazing a grazing Scheme. He proposed the difference in cost between the two be borne by African District Council⁶³⁵.

By June 1957, the Mutomo dam site at Ithumba had been cleared and the excavation of the sand in the riverbed was in progress. Classen investigated the cleared dam site closely and regretfully confirmed that the site was not suitable for construction. This was due to soil type, which composed silts derived from detritus brought down from the surrounding rock hills. The soils caused a possibility of water leaking past the core through the natural soil formation on either side of the dam wall and at the bottom of the streambed below. Consequently, the dam construction team left Mutomo leaving persistent water supply problems in Mutomo substation. They established a possibility of building a rock catchment dam capable of holding 9092 m³ to 13638 m³ of water. The quantity was adequate for the station and with a capacity for additional storage to serve the surrounding population. A little further to the north was another rock catchment of similar nature, which could be developed⁶³⁶. The Kitui DC recommended that the District officer be responsible for the collection particularly in early stages of the project⁶³⁷.

The scheme started in January 1959 with installation of a pipeline meant to supply water for eleven kilometres from Tiva River to Mutomo in the southern Division of Kitui district, 69 Kms from Kitui Township. The pipeline was supposed to supply the administrative substation, trading centre, and location centre at Mutomo. It was expected to cost KES 24,000. African land development board planned the work and the Kitui water organisation was expected to operate the scheme. It was expected that the water would be tapped at halfway between Tiva and Mutomo to cattle troughs for between 3,000 and 4,000 head of their cattle and be used by the people of Ikanga area.

635 Classen G.A (1957). Kitui District- water Supplies, Mutomo Dam. Kenya National Archives, PC/EST/1/4, Ref: IAS/1/21/A/11/96. 29th October 1957.

636 Classen G.A (1957). Mutomo Water Supply. Kenya National Archives, PC/EST/1/4, Ref: IAS/1/21/A/11/34. 31st May 1957.

637 DC, Kitui (1957). Mutomo Water Supply 1957/1958. Kenya National Archives, PC/EST/1/4, Ref: PW/8/5/17/6174. 7th December 1957.

By January 1960 the Mutomo pipeline was yet to be completed. ALDEV had completely abandoned the scheme and a new deadline for completion was set on March 1960⁶³⁸.

Mwingi Water Supply: Mwingi was the divisional headquarters of Kitui district in 1983, the mean annual rainfall was 760 to 1000mm distributed over the period March to May and October –December. The mean annual temperature was 18 to 20 degree Celsius. Mwingi water supply scheme was commissioned in 1957 and water was abstracted from Tyaa River through three boreholes. The supply was private and was made public by the hydraulic Engineer in 1957. By 1960, the main problem of the supply was contamination which could not be rectified by ordinary chlorination. Chemical analysis from Government Chemist in January 1960 showed that it was polluted with fresh sewage⁶³⁹.

The divisional engineer suggested sinking of a well in the existing pumping enclosure on the riverbank. However, the well was still likely to get chlorine, sulphide etc. impurities. Another proposal made was to equip the three government quarters in Mwingi with roof water collection and storage. The annual rainfall was about 20 inches and could provide the drinking and cooking water. Other suggestion to install a coagulation and filtration plant with necessary dual piping was tricky because of losing intake pipes through floods⁶⁴⁰.

In February, the situation was still serious and the medical officer confirmed that there were still cases of dysentery in Mwingi boma. The analyst report showed presence of decomposed vegetable matter in addition to general adulteration⁶⁴¹.

The well: In 1960, Mwingi District Commissioner, M.J. Roberts, approved the proposal to sink a well into the riverbed to provide water free from substance contamination. The DC suggested that it was important if it was done with urgency since the boma was still infested with dysentery in spite of the installation of the improved chlorination plant⁶⁴².

Mwingi Water supply was commissioned in 1999. Initially, it was conceived to cover the area described as Kitui North which later became Mwingi District in Eastern Province. It was divided into three phases for ease of implementation, with the first phase running between the main reservoir tank on Kyoera hill near

638 Hickson M.R.J (1960). Mutomo Water Supply. Kenya National Archives, PC/EST/1/4, Ref: PW.8/5/17/6/268. 30th January 1960.

639 Medical Officer of Health, (1960). Water Supplies-Mwingi Borehole. Kenya National Archives, PC/EAST/1/4, Ref: HO/F/6/60. 15th January 1960.

640 Divisional Engineer, (1960). Mwingi Water Supply. National Archives, PC/EAST/1/4, Ref: 6/3/2/1. 3rd February 1960.

641 Roberts M.J (1960). Mwingi Water Supply. National Archives, PC/EAST/1/4, Ref: ADM. 15/1/B/48. 24th February 1960.

642 Roberts M.J (1960). Mwingi Water Supply. National Archives, PC/EAST/1/4, Ref: ADM. 15/1/B/48. 24th February 1960.

Kiambere Dam and Mwingi Township, a distance of 66 Kilometres. Supply points for phase I were located at Ikuuni, Kyulungwa, Kamuwongo Kyondoo, Kathiani, Waita and Mwingi.

The project drew water from Kiambere dam reservoir by pumping to the treatment plant. Subsequent pumping boosted water to Kyoea hill reservoir tank, from where it flowed by gravity to the consumers, who are estimated to be about 100,000 people. The project was financed through a loan provided by Italian Government and TARDA was the implementing agent on behalf of the Kenya Government. The operating agent was TARDA and the supply area covered is 4km². The scheme had a storage capacity of 5550m³ with a distribution network of about 71km. Transmission was by gravity and pumping and covered about 12 km. The treatment plant was designed to condition lake water. By the year 2001, phase II and III had not been implemented⁶⁴³.

In 1983, existing water supply at Mwingi was designed for a capacity of 160 m³ per day. The three boreholes from where Mwingi Water supply was abstracted were in 1983 clogged were clogged up and water was therefore abstracted from Abyssinian wells (a kind of well point system), but only one well was operational. The treatment consisted of chlorination only, although the water was very saline due to excessive mineral content. The capacity of this scheme was completely inadequate for the demand and average production of water was only 20 m³ per day while the maximum was 40 m³ per day⁶⁴⁴.

Proposed water supply: East Africa Engineering Consultants (K) was appointed to undertake design and supervision of Mwingi Minor Urban Water Supply in December 1980, and the agreement was signed in January 1981. The estimated demand and population projections are as shown in Table 3.31.

Table 3.31: Population and water demand projection in Mwingi by 1979

Year	1979	1995	2005
Population	2300	5840	10460
Water demand (m ³ per day)	230	700	1400

⁶⁴³ The World Bank WSP – EASA (2001). The Development of the National Policy on Environmental Sanitation and Hygiene: A Situation Analysis on the Legal, Institutional and Resource Mobilization Frameworks Affecting the Environmental Sanitation and Hygiene (ESH) Sub-Sector in Kenya. Draft report.

⁶⁴⁴ The World Bank WSP – EASA (2001). The Development of the National Policy on Environmental Sanitation and Hygiene: A Situation Analysis on the Legal, Institutional and Resource Mobilization Frameworks Affecting the Environmental Sanitation and Hygiene (ESH) Sub-Sector in Kenya. Draft report.

The consultant was instructed to investigate the possibility of extending the Yatta Canal (figure 3.30) to Mwingi and use the water from the canal as a new source for Mwingi Water Supply. However, it was not feasible financially. The cost of extending the canal over a distance of 134km was between KES 71 and 130 million. The consultant therefore settled for the original proposal to abstract subsurface water in Tyaa River. The river had a catchment area of approximately 100km² at the proposed intake site which was sufficient for Mwingi supply. By 1983, investigations were underway to determine what was necessary to store sufficient water for the dry season, 3 to 6 months, or if a huge sub surface layer of the river sand contained enough water to meet the requirements. The estimate cost of construction for this project was KES 15 million⁶⁴⁵.



Figure 3.30: The Yatta Canal in 1983⁶⁴⁶

⁶⁴⁵ The World Bank WSP – EASA (2001). The Development of the National Policy on Environmental Sanitation and Hygiene: A Situation Analysis on the Legal, Institutional and Resource Mobilization Frameworks Affecting the Environmental Sanitation and Hygiene (ESH) Sub-Sector in Kenya. Draft report.

⁶⁴⁶ The World Bank WSP – EASA (2001). The Development of the National Policy on Environmental Sanitation and Hygiene: A Situation Analysis on the Legal, Institutional and Resource Mobilization Frameworks Affecting the Environmental Sanitation and Hygiene (ESH) Sub-Sector in Kenya. Draft report.

It was recommended that NORAD finance design and construction of Mwingi water supply, providing the cheapest alternative of abstracting water from Tyaa river. If the more expensive option of extending the Yatta canal was chosen, it was recommended that the ministry arrange for another donor.

Kangundo/Tala Water Supply: Kangundo was designated as an Urban and Tala as a rural centre. There were two boreholes one at each centre which supplied water to the area. The project to serve Kangundo/Tala and the area between was only a first phase in a bigger project supposed to serve the whole surrounding with a population of more than 100,000 persons. Originally Athi River was chosen but the 1983 proposal was to drill two more boreholes. The original cost estimated was KES 600,000 compared to 1983 estimates of 1,600,000. Kangundo/Tala Water supply was included in a water supply constructed by ministry of local government. No expenses were charged to the MUWS.

By the year 2001, Kangundo town council comprised of Kangundo constituency and two divisions of Kangundo and Matungulu in Machakos district. The management of the water supply kept changing hands between 1946 and 1999 as shown in Table 3.32⁶⁴⁷.

Table 3.32: The water operators at Kangundo water supply

Period (Year)		Water operator
1946	1958	Colonial Government
1958	1979	Masaku county Council
1979	1992	Tala/Kangundo Urban council
1992	1999	Kagundo Town Council
1999	2001	Romane Agencies

Kangundo Water Supply was a borehole meant to serve Tala town covering a supply area of 4km². The borehole, with a tested yield of 105m³/hour, was drilled and commissioned in 1946. It was equipped with an electrical submersible pump whose pumping rate was estimated to be 45 m³/hour and water was pumped for 24 hours

⁶⁴⁷ The World Bank WSP – EASA (2001). The Development of the National Policy on Environmental Sanitation and Hygiene: A Situation Analysis on the Legal, Institutional and Resource Mobilization Frameworks Affecting the Environmental Sanitation and Hygiene (ESH) Sub-Sector in Kenya. Draft report.

day. The average daily production was 100 m³ against an estimated water demand of 750 m³ per day⁶⁴⁸.

This status continued until July 1999 when the management of the scheme experienced many operational problems and dismal performance. Some of these problems included poor operation and maintenance practices, council's inability to purchase materials for O & M repairs, lack of resources to settle electricity bills, inadequate supply of water to meet the demand of the growing urban population and inability to enforce revenue collection among other⁶⁴⁹.

The number of boreholes were increased to three and equipped with submersible pumps, each serving an independent reticulation system to enable the council served an estimated population of 200,000 people and an area of 598km² by the year 2001. Nonetheless the town council experienced acute shortage of potable drinking water despite the existence of the three borehole sources. The yields from the boreholes were low in addition to the unnecessary three hours of pumping (very little time) instituted by the water managing authorities, especially in Kangundo and Nguni, aimed at curtailing the escalating cost of electricity power consumption. The two boreholes were managed by the town council while the management of the third, Tala borehole, was taken by a private firm, Romane Agencies, on a 30 year contract. In both managements there was little or no data at all in operation and maintenance performance of the water systems. The water was screened to prevent blockage before entering the pipeline. However, the screening was inadequate to prevent the silting of the pipeline in 1983⁶⁵⁰.

Unaccounted for water [UFW] through uncontrolled consumption was expected to be alarmingly high⁶⁵¹.

In view of the above bottlenecks, the council resolved to privatize the provision of water services in Tala Town by entering into a 30-year service contract with

648 The World Bank WSP – EASA (2001). The Development of the National Policy on Environmental Sanitation and Hygiene: A Situation Analysis on the Legal, Institutional and Resource Mobilization Frameworks Affecting the Environmental Sanitation and Hygiene (ESH) Sub-Sector in Kenya. Draft report.

649 The World Bank WSP – EASA (2001). The Development of the National Policy on Environmental Sanitation and Hygiene: A Situation Analysis on the Legal, Institutional and Resource Mobilization Frameworks Affecting the Environmental Sanitation and Hygiene (ESH) Sub-Sector in Kenya. Draft report.

650 Hunn G. (1983). Progress Report About water Projects included in the Minor Urban Water Supply Programme. NORAD –Coordinator/MOWD. Nairobi Ref: WD/1/2/5. 10th June 1983.

651 The World Bank WSP – EASA (2001). The Development of the National Policy on Environmental Sanitation and Hygiene: A Situation Analysis on the Legal, Institutional and Resource Mobilization Frameworks Affecting the Environmental Sanitation and Hygiene (ESH) Sub-Sector in Kenya. Draft report.

Romane agencies. The scheme had no treatment works with a storage capacity of 55m³. The distribution network covers 5.5 km⁶⁵².

Water supply in detention and work camps in Eastern Province: Water supply was supposed to be in the hands of hydraulic branch of PWD. The minimum requirement was 45.5litres per detainee per day. Water from streams required chlorination and was supposed to be sampled regularly by the government analyst. Boiling and filtration were recommended for European officers. The centre for camping was supposed to be gently sloping for effective drainage of sullage and storm water and be constructed away from the prevailing winds to avoid smells, smoke or noises⁶⁵³.

At Mwea, Tebere and Ishiara Camps in Embu district, Aguthi and Mwea water works camps in Nyeri district, Kangeta works camp in Meru and Kigumo works camp, water supplies were unsatisfactory and required chlorination. Chlorination was similarly necessary in South Yatta and Narok Camps in southern province and Makutano camps in Rift Valley Province⁶⁵⁴.

Ishiara, Mwea and Tebere were the only camps in Embu district. Ishiara was used for repatriates from Manyani and Mackinon Road who were re-screened from there. The compound was too small to accommodate all and some were held at Embu Prison. Water at this camp as in any other in Embu District was not chlorinated. It was from a river. There was however, no sickness and the DC assured that there was no need for chlorination particularly because the detainees would not drink chlorinated water⁶⁵⁵.

Water supply at Githiga works camp was drawn by hand from the local river and used for the works camps downstream. The borehole sunk by public works department in early 1956 did not yield any, but muddy water, insufficient to supply the needs of the camp. The director of medical services observed that the only alternative lay in pumping water from the river, filtering with chlorination and storing in a storage tank⁶⁵⁶. In September 1956, Githiga detention camp borehole

652 The World Bank WSP – EASA (2001). The Development of the National Policy on Environmental Sanitation and Hygiene: A Situation Analysis on the Legal, Institutional and Resource Mobilization Frameworks Affecting the Environmental Sanitation and Hygiene (ESH) Sub-Sector in Kenya. Draft report.

653 Director of Medical Services (1955). Remarks upon Construction, Hygiene & Conservancy of Detention and Works Camps, Kenya National Archives, BY/61/5, Ref: 4/417/32. 21st January 1955.

654 Stott H (1954). Chlorination of Water supplies. Kenya National Archives, BY/61/5. 17th September 1954.

655 Dent H.D (1954). Tour in Embu District by S.O (Q). Kenya National Archives, JZ/18/4. 5th to 8th September 1954.

656 Drury G.D (1959). Water Supply – Githiga works Camp, Kiambu. Kenya National Archives, BY/61/3, Ref: 14/415 VOL.II/93. 24th September 1956.

was abandoned and no further boring was proposed but instead an estimate for pumping from stream and filtering was prepared⁶⁵⁷.

In Marwaha and Kasturi Singh camp water was brought from Athi River twice monthly. Whenever the tanks ran dry, the only water available was found in water holes and swamp. The water was to all appearances unfit for drinking purposes and dysentery and enteric were commonplace. The water was ridiculously inadequate⁶⁵⁸.

3.3.2.6 Central Province Water Supplies

Karatina Water Supply: Karatina, situated 140km north of Nairobi along Nairobi-Nyeri road is located in a high potential agricultural area in the slopes of Mt. Kenya, 1700 metres above the sea level. By 1983, Karatina was a fast growing commercial centre in East Africa⁶⁵⁹.

The existing water works by 1983 had a capacity of 500m³ per day built in 1950's and were no longer able to cope with the increased water demand. The first design prepared by the departmental section of MoWD in 1978, envisaged a new treatment plant and a high lift pumping station at the same place. The population and water demand projections between 1987 and 1997 for Karatina is illustrated in Table 3.33.

Table 3.33: Population and water demand projections in Karatina by 1997

Year	1987	1997
Population served	7900	15500
Water demand (m ³ per day)	1130	2500

The civil works expected to be carried out in 1983 included a new treatment works with a capacity of 2500 m³ per day, gravity main of 200mm diameter and two storage tanks of 450 m³ each. Trenching work, illustrated in figure 3.31, was done later to enable laying of pipework.

657 Dalmege, J.J de G (1956). Water Supply: Githiga Works Camp. Kenya National Archives, BY/61/3, Re: DEF.89/2/2/4/246. 28th September 1956.

658 Sanitary Inspector (1928). Enteric Fever Outbreaks on Ballast Camps between April River Station and stony Athi. Kenya National Archives, BY/61/3, Ref: 3/M Mise. 23rd April 1928.

659 Hunn G (1983). Progress Report About water Projects included in the Minor Urban Water Supply Programme. NORAD –Coordinator/MOWD. Nairobi Ref: WD/1/2/5. 10th June 1983.



Figure 3.31: Trenching for the 8-inch pipeline leading to the main reservoirs in 1983⁶⁶⁰.

In April 1983, there was an additional cost of 4.5 million KES to 9.0 million KES, in addition to project funds, it included 0.3 million KES for the salary and allowances for work. With availability of funds, the project was projected to be completed by 1983 December⁶⁶¹.

Evaluation by Nor Consult in 1989 indicated that the project was in a good condition and could meet the demand up to 1993⁶⁶².

Sagana Water Supply: Sagana is an urban centre in Kirinyaga district, central province. The centre is situated 114km North North-East of Nairobi along Nairobi Nyeri Road. By 1983, there was no official water scheme in Sagana, but piped water was supplied from small private projects belonging to institutions and to Kenya railways.

The Ministry of Water Development undertook to provide water through a project limited to supply Sagana Township and its outskirts. Raw water flowed gravitationally from river Ragati to the main supplies works still under construction then to the storage tanks. Most of the parts were complete and expected to be commissioned any time in 1985. In 1984, there were few metered connections fixed and

660 Hunn G (1983). Progress Report About water Projects included in the Minor Urban Water Supply Programme. NORAD –Coordinator/MOWD. Nairobi Ref: WD/1/2/5. 10th June 1983.

661 Hunn G (1983). Progress Report About water Projects included in the Minor Urban Water Supply Programme. NORAD –Coordinator/MOWD. Nairobi Ref: WD/1/2/5. 10th June 1983.

662 Nor Consult A.S (1988). Development of an Integrated Physical/Financial/Socio-Economic Monitoring and Evaluation Programme for Water Supply Schemes, Draft Final Report, Report No. 9. Ministry of Water Development, Republic of Kenya.

consumers took raw water while awaiting the completion of the Treatment works. Figure 3.32 is a peek into the treatment works⁶⁶³.



Figure 3.32: Sagana treatment plan under construction, slow and sand filter excavated in 1983⁶⁶⁴

A map of Sagana supply works encompassing the gravity mains, reservoir and treatment works is illustrated in figure 3.33.

663 Ministry of Water Development (1984). Kirinyaga District. Kenya National Archives X5/2/5. 1984.

664 Ministry of Water Development (1984). Kirinyaga District. Kenya National Archives X5/2/5. 1984.



Figure 3.33: Map Illustrating Sagana water supply⁶⁶⁵

The design for Sagana water supply was prepared by the Ministry's departmental design section in 1978. The construction started in 1980, by a team from the Ministry's direct labour section. The population demand and water demand figures were projected as tabulated hereafter. Table 3.34 demonstrates population projection against the water demand between 1977 and 1997.

⁶⁶⁵ Ministry of Water Development (1984). Kirinyaga District. Kenya National Archives X5/2/5. 1984.

Table 3.34: Population and water demand projections in Sagana in 1997

Year	1977	1987	1997
Population	5500	10910	19440
Water Demand (m ³ per day)	333	669	1200

The original design called for full treatment as well as low lift and high lift pumping. The high operational costs prohibited implementation and therefore the design was completely revised in 1981.

The intake was moved 7km upstream of the Ragati River and the conventional treatment plant was replaced by a slow sand filter. The filter would be operational for 24 hours per day and required limited operation and maintenance. The slow sand filter was to be the first ever built in Kenya and did not require any chemical apart from chlorine. The storage tank in Sagana was well big and well laid (figure 3.34) to satisfy the needs of the consumers.



Figure 3.34: An underground block storage water tank with a capacity of 300m³ in Sagana in 1983⁶⁶⁶

The design change caused delay in implementation estimated to approximately one year, but far better technical solution to lowers the cost was found and by 1983, the supply was expected to be more reliable. The total cost for Sagana water supply was

⁶⁶⁶ Hunn G (1983). Progress Report About water Projects included in the Minor Urban Water Supply Programme. NORAD –Coordinator/MOWD. Nairobi Ref: WD/1/2/5. 10th June 1983.

KES 7.2 million and the scheme was expected to be completed by the end of 1983 with availability of sufficient funds.

Mwea Tebere Water Supply: By July 1956 seventeen villages were chosen in the Tebere blocks in the Mwea irrigation Scheme in the Embu District for about 1,500 Landless whites and for the future settlers in the scheme. Mr. C.M Johnson, the Special Commissioner, on request, submitted an estimate of 50,000pounds for water supplies for the Mwea/Tebere villages. He also included a sum of 2,500pounds for borehole construction in Wamumu camp, whose supply was quite poor⁶⁶⁷.

The medical department ensured that the danger of contracting Bilharzia was minimal. The department directed sinking of infiltration wells at some distance from the main irrigation canals and furrows. In addition, the department advised on pumping water by hand pumps to two 22.7 m³ tanks situated near each village. It was from these tanks that the prescribed dosage of chloride of lime was added⁶⁶⁸.

The cost of digging the wells and installing the necessary plant was estimated as KES 20,000 for each village and in ten villages two pumps were required each costing KES 340,000, therefore making a total sum of KES 360,000. The public works department required this amount by the end of 1956/57 financial year⁶⁶⁹.

Wamumu approved school had 1,100 boys and was dependent on irregular supply from a drainage channel. During shortages, water was transported to the school in drums from Thiba River some six kilometers away. To augment the supply, a borehole was proposed. The cost of boring the to a maximum depth of 213 metres was estimated as KES 300,000 and the installation of a pumping plant and other requirements estimated as KES 30,000⁶⁷⁰.

Minor additional water supplies were recommended for Gathigiriri and Thiba camps at an additional cost of KES 20,000. Overall a total of KES 440,000 was estimated for augmentation of water supplies in Mwea⁶⁷¹.

The schemes were undertaken on an individual village basis. The construction work started around early 1957 and continued through 1958 in various places. At Mathanguata, a tank for sand filter and two 6.8 m³ storage tanks and a draw off point were already constructed by June 1958 at an approximate cost of KES 6000.

667 Johnson, C.M (1956). Water Supplies-Mwea Tebere Villages. Kenya National Archives, DC/ EMB/2/6/1, Ref: LND. 54/14/5/11/148. 2nd July 1956.

668 Johnson, C.M (1956). Water Supplies-Mwea Tebere Villages. Kenya National Archives, DC/ EMB/2/6/1, Ref: LND. 54/14/5/11/148. 2nd July 1956.

669 Special Commissioner (1956). Water Supplies-Central Province. Kenya National Archives, DC/ EMB/2/6/1, Ref: LND.34/14/5/11/154a. 7th July 1956.

670 Special Commissioner (1956). Water Supplies-Central Province. Kenya National Archives, DC/ EMB/2/6/1, Ref: LND.34/14/5/11/154a. 7th July 1956.

671 Special Commissioner (1956). Water Supplies-Central Province. Kenya National Archives, DC/ EMB/2/6/1, Ref: LND.34/14/5/11/154a. 7th July 1956.

Mwathaine was partly completed and what remained was filling the sand filter, erecting the windmill pump and laying piping, all at an approximate cost of KES 600,000. Work had not been started at Mugomoine and Matandara⁶⁷².

The Health inspector observed that it was economical if the government staff rather than a contractor carried out the Mwea/Tebere village water supplies. He estimated a 15% lower cost from 16,700 to 12,000 shillings for gravity fed installation and from 22,400 to 16,000 shillings for the windmill pump supply if the government supply was adopted in preference to contractor Messrs. G. North and Sons⁶⁷³.

Each village had to have either windmill pump or gravity fed supply. The sources of the supply were the canal or feeders except in Mahigaine where a river was used. All the materials had to be ordered by 12 December 1958⁶⁷⁴. The estimates for installing slow sand filtered water system for the villages were as shown in Table 3.35.

Bilharzia Control: The meeting of the provincial medical Officer, Medical inspector, and the WHO advisory committee discussed the future of Bilharzia control. They passed on the following: A continued examination of all entrants for microscopic examination of urine and stool (this was the existing control method). Snail control through dosing of all main branches, close examination of the ecology of the snail production and examination at six month intervals of all children within the age bracket of six months to ten years (the most vulnerable group) and use of pentachlorophanate as molluscicide⁶⁷⁵.

Table 3.35: Estimated cost for installing slow sand filtered water system

Village	Amount (KES)
Mahigaine	25,000
Kilimani	19,500
Kirogo	18,300
Kiriko	21,500
Mathanguata	4,500
Gathigiriri	21,050
Kamuchege	13,500
Nguka	40,500
Getuto	35,900
Total	199,750

672 Health Inspector, Embu (1958). Mwea Tebere Scheme-Village Water Supplies. Kenya National Archives, DC/EMB/2/6/1, Ref: 2/M/18/59. 10th June 1958.

673 Health Inspector, Embu (1958) Mwea Tebere Scheme-Village Water Supplies. Kenya National Archives, DC/EMB/2/6/1, Ref: 2/M/18/59. 10th June 1958.

674 Mills R.G (1958) Village Water Supplies-Mwea/Tebere Irrigation Scheme. Kenya National Archives, DC/EMB/2/6/1, Ref: MT/44/98. 24th November 1958.

675 Provincial Medical Officer (1958). Water Supplies and Sewage Disposal-Mwea/Tebere Villages. Kenya National Archives, DC/EMB/2/6/1, Ref: LND.33/F, 11th December 1958.

In February 1959, a survey of inhabitants of Nguka established 22 cases of Bilharzia from about 300 specimens examined. Most of these cases were in children who contracted the disease since entering the irrigation scheme. One third to one half of all the children in Nguka area was found with microscopic evidence of the disease after examination. In order to treat these cases, construction of a treatment camp was proposed at Kimbimbi. The enlargement of the dispensary in the local available means was also proposed. Extra housing for more nursing staff was recommended near the dispensary compound⁶⁷⁶.

In 1961, The PS in the Ministry of Health expressed concern over the spreading of the Bilharzia in the irrigation scheme. Bilharzia figures showed an increased prevalence over the past four years (1956 to 1960) with 'two small explosives' in 1959 and 1960. From 1960, the prospect was that Bilharzia could spread easily throughout the whole irrigation scheme⁶⁷⁷.

The permanent secretary indicated that Bilharzia was difficult to control and no measure on its own could successfully eradicate the vector. One means of combating Bilharzia, according to Professor Macdonald of the Ross institute of Tropical Medicine and London school of Hygiene, was to concentrate on the local points and provide safe and portable water supplies together with domestic facilities within easy reach of the villages to reduce the risk of contracting infected water or to pollute the uninfected water. The PS insisted on installation of safe and portable water supplies at each of the villages together with laundry facilities. He suggested on tackling the infected villages, Kimbimbi, Nguka and Mura-bura first⁶⁷⁸.

General maintenance: Water was unsatisfactorily controlled in the canals, and as Squires observed, ran poorly along the channels. Water carried gross overloads, which eventually damaged the channels and possibly the structures. Mr. Taylor, the manager Mwea/Tebere Irrigation Scheme stated that much of the unsatisfactory water control was due to faulty construction work on the Ministry of Works, hydraulic branch. In 1961, the provincial medical officer, Central province, informed the permanent secretary in the ministry of health, N.R.E. Fendall, that water supplies to Mwea/Tebere irrigation scheme, was unsatisfactory. This was so after the original allocation of 21,000 pounds from the emergency vote in 1956. Three villages were scheduled to receive safe and portable supplies, Kimbimbi, Nguka and Mura-bura⁶⁷⁹.

676 Provincial Medical Officer (1959). Mwea/Tebere Irrigation Schemes. Kenya National Archives, DC/EMB/2/6/1, Ref: 85/1, 7th March 1959.

677 Provincial Medical Officer (1959). Mwea/Tebere Irrigation Schemes. Kenya National Archives, DC/EMB/2/6/1, Ref: 85/1, 7th March 1959.

678 Fendall N.R.E (1958). Mwea Tebere Water Supplies. Kenya National Archives, DC/EMB/2/6/1, Ref: DAN/Vol/111/58, 9th May 1958.

679 Fendall N.R.E (1958). Mwea Tebere Water Supplies. Kenya National Archives, DC/EMB/2/6/1, Ref: DAN/Vol/111/58, 9th May 1958.

Kimbimbi Dispensary Water Supply: According to Taylor, the best method to provide the dispensary with water supply was by pumping alternative draw off points of Kimbimbi Furrow, scheme canal and Nyamindi River. The Kimbimbi furrow took off from a temporary head thus was irregular and unreliable. The residents of Kimbimbi used it for various purposes and therefore likely to be polluted henceforth, unsuitable for the dispensary. The best alternative was to pump from Nyamindi River although the piping required was quite expensive⁶⁸⁰. According to the District officer, funds supplied for the construction of African Staff quarters were to be provided for water supply to Kimbimbi dispensary⁶⁸¹.

Nanyuki Water Supply: Nanyuki was the northern most township of the central province and was associated with military. The military impacted considerably on water supply sanitation of Nanyuki. By 1954, the population of Nanyuki had increased beyond expectation and since emergency there were large numbers of African and British troops from time to time as well as extra police. The drainage, health and other social services of Nanyuki were not enough for the existing population and its needs. According to the Health Inspector report of 1954, there were 8000 Africans, 1400 Asians and 200 Europeans. There were 2000 and 200 African and European armies respectively. The township occupied an area of 5300 acres of which 800 acres were reserved for the army⁶⁸².

Water supply was operated by the public works department and was drawn from Liki River at a point some six kilometers above the township inside Mount Kenya forest. It was directed into three reservoir tanks each with a capacity 1137 cubic metres capacity and was treated by, dosing with alum and chlorine. The supply was adequate and safe. The water was sufficient and by November 1954, water borne sanitation had been installed⁶⁸³.

The scheme was commissioned in 1984 and by 2001 met the demand despite the fact that the distribution system pipe network coverage was less than 80 %. It had a supply area of 150km² and served a population of about 60,000 people.

The water supply served Nanyuki Municipality, Liki, Marura and Nturukuma locations of the central Division of Laikipia District. By the year 2001, the scheme had extended its services far and beyond the Nanyuki Municipal Council area of

680 Taylor D.P (1959). Letter P.H.10/1/2/ of 23-3-59. Kenya National Archives, DC/EMB/2/6/1, Ref: MT/78/VOL.11/48. 31st March 1959.

681 Divisional District Officer, Gichugu, (1959). Mwea/Tebere Irrigation Scheme-Bilharzia. Kenya National Archives, DC/EMB/2/6/1, Ref: PW.8/5/4/11/61. 16th June 1959.

682 Health Inspector (1954). Nanyuki Township. Kenya National Archives, BY/29/40, Ref: 14/B/46. 17th November 1954.

683 Health Inspector (1954). Nanyuki Township. Kenya National Archives, BY/29/40, Ref: 14/B/46. 17th November 1954.

jurisdiction and the Laikipia District administrative boundaries to Ontulili location of Meru District.

The water supply system was owned and operated by the municipal council of Nanyuki which had a fully-fledged department of water and sewerage, headed by the General Manager. The scheme was fully metered with a total of 4,365 consumer connections as at May, 2001. The scheme had a maximum production capacity of 10,500 m³/ day but was producing 7,200 m³/ day, which was more than what was required to meet the existing demand. The scheme had a total storage capacity of 4390 m³ with a network of 95 km. The transmission mains covered a length of 9 km⁶⁸⁴.

Kangema Water Supply: Kangema was a small town in Murang'a district of central province. Kangema urban water supply was obtained from a pumping scheme with a supply area of approximately 1km² serving a population of about 18,000 people. The water supply was commissioned in 1953 with a design production capacity of 30 m³/day meant to serve a small population of white settlers in the area. The scheme was producing water at a rate of 68 m³/ day. Among the schemes main consumers were the K.C.C. Milk processing plant, the slaughterhouse, Muguru secondary school and households within Kangema Township and its environs. The source of the water supply was Mathioya River.

The scheme was managed by the National Water Conservation and Pipeline Corporation [NWPC]. It was metered scheme with 370 consumer connections of which only 180 were active. Most metres were faulty and consumption was billed on estimation. The production by 1983 could not meet the demand. However, there was a proposal to connect the existing water supply system to the 3" diametre line from phase I of Kahuti water supply. The scheme had a total storage capacity of 226 m³ with a distribution network of 12 km. The transmission mains covered 4.5 km and were both by gravity and pumping. The treatment works consists of clarifiers, chlorine dosing units and clear water tanks. The scheme was commissioned in 1953⁶⁸⁵.

Nyahururu Water Supply: Nyahururu Town was established in the early twentieth century as a Service Station to serve the surrounding agricultural farms of the former white settlers between Uaso Narok River and Nyahururu stream. The purpose of the

684 The World Bank WSP – EASA (2001). The Development of the National Policy on Environmental Sanitation and Hygiene: A Situation Analysis on the Legal, Institutional and Resource Mobilization Frameworks Affecting the Environmental Sanitation and Hygiene (ESH) Sub-Sector in Kenya. Draft report.

685 The World Bank WSP – EASA (2001). The Development of the National Policy on Environmental Sanitation and Hygiene: A Situation Analysis on the Legal, Institutional and Resource Mobilization Frameworks Affecting the Environmental Sanitation and Hygiene (ESH) Sub-Sector in Kenya. Draft report.

railway line was to assist the transportation of wheat, barley, pyrethrum and refined milk (cream) to Nairobi. Its history is credited to the explorer Joseph Thomson, who was commissioned by the Royal Geographical Society in 1880s to explore the interior of East African Region, and in the process became the first European to see the 61 metres water fall near the town named after him. The town derived its first name (Thomson Falls) from the explorer's name.

The documented water supply for Nyahururu (then known as Thomson Falls) was completed and brought into operation in April 1949 and the motive power was that of hydam. Due to increased water demand in the township some extensions to the reticulation system were carried out with the requisite installation and additional pumping units done in 1950.

In 1952 the capacity of treatment works was increased by the construction of a new coagulation basin and rapid sand filter to produce 18.2 m³ per hour and a 15 centimetre diameter rising main to cope with increased demand and additional hydrants were also installed. By 1955, the water plant was working at its limit. To alleviate the problem, additional large capacity pumps were ordered. The treatment plant was based on coagulation, filtration (rapid sand) and chlorination processes.

In early 1970s, some Water Supply works were designed, carried out and completed in 1973⁶⁸⁶ when it was opened by the then Local Government Minister, Hon Dr Julius G. Kiano.

Intake: Intake was as the present one just above Thompson Falls and water was pumped from the intake through 38mm diameter centrifugal pumps. The pumps and the switchgear were housed in a masonry pump house.

Rising Main: There were three rising mains with the following sizes: 150mm, 100mm and 75mm. The Supply was measured through 150mm Kent 2000 Helix master metre.

Treatment Works: The works were constructed by United Filters and Engineering Co. Ltd in 1973 with the following facilities including associated building and equipment: Sedimentation with flocculation arrangements, rapid gravity filtration, chlorination, equipment for dosing chemicals for water treatment and chlorination, small laboratory with equipment for assessing chemical residuals, surface reservoirs at treatment works of 454.5m³, 113.6m³ and overhead tank of 204.5m³ of Braithwaite (metal panels) construction.

The deficiencies in the existing works by 1975 included the following:

686 East African Consulting Engineers (1976). Nyahururu Water Supply Treatment Woks Design Report. Ministry of Local Government. August 1976.

- Most metres were not operating;
- No arrangement for stopping off the intake either by sluice, penstock, stop-log gate to allow the channel to allow channels to be cleaned; and
- Backwash procedures were poor and many valves and metres, gauges, recorders, blowers etc. were faulty.

In 1975 East African Engineers Consultants asked to investigate the water system and their recommendations resulted in following Short Term Measures, (which were carried out mid 1976) and comprised the following works: Reconnecting existing 150mm and 100mm diameter raw water rising mains in the parallel; revision of other pump pipe work; installation of a bulk metre; replacement of one of the new water pumps; and installation of new wash water troughs.

Later, the problem of low pressure in the distribution system led to the need for water master plan. But before this could be carried out the East African Engineers Consultants were commissioned in 1978 to carry out Final design Report of the “Immediate Works” recommendations and Preliminary Design Report covering a period up to 1990 with allowances for year 2000. This Report on the Survey of the existing Water Reticulation within Nyahururu Township was given to Ministry of Local Government in 1979.

In 1983, water was pumped or gravitated to storage tank before being distributed to consumers by gravity (figure 3.35). Overhead steel tanks or surface tanks usually built of concrete blocks were used to command different areas in a scheme.



Figure 3.35: Storage tank from where water was distributed by gravity⁶⁸⁷

687 Hunn G (1983). Progress Report about Water Projects Included in the Minor Urban Water Supply Programme. NORAD, Nairobi.

The Town was gazetted as an urban council in 1954. On attainment of independence in 1963, the Council became second tier authority of Laikipia County Council in Laikipia District. However, through the Presidential Decree of 1967, the town became the Headquarters of Nyandarua District and was administratively transferred to Nyandarua County Council. In spite of this arrangement the boundary was never altered and therefore the town remained within Laikipia District. In 1974, the Nyahururu Town became a Town Council and was later elevated to Municipal status on January 22, 1982. In 1994, the town was taken back to Laikipia both politically and administratively under the Kenya Gazette Notice dated February 1994 through the District Commissioner for Nyahururu is still housed in the Town.

The 1989 Kenya Population census reported that the Nyahururu Municipality population as being 14,829 people. These were 7,779 males and 7,126 females reported in 3,686 households for an area density of 8777 persons per square km or average of 4 persons per household. This is an increase in the growth rate from 1969 to 1989, which estimated a rate of increase from 2.8%. The census estimated that by year 2003 the population would have reached 24,857 persons.

In 1982, East African Engineering Consultants designed Phase I of Nyahururu Water Supply Project and incorporated some old existing treatment works and distribution system. The project was completed in 1984 when it was opened by the then Local Government Minister, Hon. Moses M. Mudavadi. The facilities that were provided by project included the following: Intake works on River Uaso Narok; Pump house next to the intake; raw water rising main from the pump house to raw water balancing tank; raw water balancing tank in the treatment works site; treatment works located at the “old” treatment works site some 1800m from the intake; treated water reticulation system within Nyahururu Municipality; and re-arrangement of bulk metering.

In addition the East African Engineering Consultants designed Phase II of Nyahururu Water Supply Project which was to cover provision for additional facilities “to cater for the projected water demand up to the year 2000”. The facilities that were to be provided in Phase II were as follows: A duplicate parallel raw water rising main from pump house to the balancing tank; a second raw water balancing tank at the treatment works site; extension of the treatment works; and additional treated water reservoirs.

The distribution system was rehabilitated between 1985 and 1987 to improve water supply in town. Njama Construction Company carried out the work.

In 1989 the Ministry of Local Government on behalf of the Municipal Council of Nyahururu engaged the services of a H. P. Gauff KG and Uniconsult (K) Ltd consulting engineers to look into all the aspects relating to the improvement of the

operation and maintenance of the existing facilities as well as give recommendations for future development. One item of the terms of reference was:

“Assess report and recommend remedial measures on facilities for raw water production, water treatment and distribution with priority ranking and cost estimates”.

Revision of Metre Reading System was carried out by Samez Consultants, who finished the same in October 1993.

Murang’a Water Supply: In 1900 between the months of October and September Mr. F. E. Hall left Machakos with circa 40 armed porters and a company of East African rifles to found a station in the current Murang’a district. On one of the three wooded hills called the Mbiri, some 500 metres from Mathioya River and at an altitude of 4410ft he built a fort. This fort bore his name. Some of the masonry survived until 1928 and that year a plaque was set in one of pillars commemorating the foundation of the station. The original name the Mbiri survived until 1901 when the station founder died. The first official visit to the station was by Sir Charles Eliot (Governor) in July 1901, when the station accounts were audited⁶⁸⁸.

When Kenya was gazetted as a province in 1902 the Senior Resident Commissioner was stationed at Fort Hall. Fort Hall was gazetted as a township on 10th December 1909. In 1910, Motor service was opened between the station and Nairobi, while at the same time 20 shops had been built in the bazaar. The approximate import into Fort Hall was KES 250,000 while 103 tons of various grains were sent out to Nairobi from Fort Hall, 8,500 porters being employed. In the same year the Public Works Department put in a new road to Nyeri. More development was experienced in Fort Hall in 1911 when a market place, meat market, slaughter house, 24 huts for gaol warders and station staff, stable and kitchens on the camping ground and a new store for the prison were put in.

The population at Fort hall was more 200 people. By 1914 there were four inhabited houses in the Boma. The District Commissioner’s, the Asst. District commissioner’s, the Doctor’s house and that of the Police officer. At this time the station was the gateway to Kenya province and had become a natural stopping place for all travellers. The outbreak of World War I led to the station being run by the DC alone⁶⁸⁹.

688 Colony and protectorate of Kenya (1913-1959). Kisumu water supply, BY/35/2 Kenya National Archives, Nairobi, Kenya.

689 Colony and protectorate of Kenya (1913-1959). Kisumu water supply, BY/35/2 Kenya National Archives, Nairobi, Kenya.

Although the main pestilence to the people of Kenya was malaria at that time (1900), Fort Hall was seen as favourable in respect to the same. However, the officers in the station suffered considerable ill, which was ultimately found to be due to water supply. The population of the station was composed of one white officer, 28 men of the King's African ruffles, and 11 Indian traders. There were 61 Indian traders in all in the district.

This increase in population needed better water supplies. Early in 1909, owing to continuous ill health of officers a bacteriologist was sent to Fort Hall to make some investigation. He stated that the water supply was heavily infected and that in future nothing except rain water could be used. In 1911 the water supply was improved considerably by institution of a water cart for which a rate was levied. In 1912 the township had the population shown in Table 3.36 below⁶⁹⁰.

Table 3.36: Population of Murang'a by 1912

Composition	Number
European (Male)	4
Goans	9
Indians	36
Swahilis and other aliens	60
Total	109

Considerable difficulty was experienced over the water supply as a new water cart promised by the government was not supplied; as a consequence a large amount of manpower had to be employed on this service, leading to requisition of labour for work which should have been done by station hands.

Convicts were employed on carrying water, road-making, grass-cutting, cutting wood and shamba work. The population in 1915 had reached 467. In the same year (1915) a water furrow some seven or 12 kilometres in length receiving its water from the Karichungu River was completed. Passing the officers houses, police station, post office, clerk's houses, police lines, warders and retainers lines, and the bazaar, it emptied itself into the Muara River.

In considering any proposals for the improvement of sanitation, the issue of water supply invariably arose. The existing methods of water supply were insufficient and expensive. During the year 1924, over 3,000 shillings were spent on water supply and purchase of petrol cans, repair of carts and replacement of oxen. This

⁶⁹⁰ Colony and protectorate of Kenya (1913-1959). Kisumu water supply, BY/35/2 Kenya National Archives, Nairobi, Kenya.

figure did not include the value of services of sixteen prisoners daily, which was approximately 1600 shillings. Installation of water was estimated to bring in revenue of 2000 shillings by charging all the government employees, the hospital, the goal, police lines and selling in public kiosk⁶⁹¹.

Intakes on large rivers liable to severe flooding were difficult to design; in some cases floating intakes which could accommodate the changes in the river depth were used. However, they sometimes could be washed away during violent floods in 1983. This called for more innovation and a floating intake (figure 3.36) was developed. In 1980, Murang'a Township was the district headquarters for Murang'a District. Murang'a water Supply was completed in 1980, at a cost of KES 9.6 million. The Normal construction period for such scheme was 2 years but delays occurred due to lack of funds.

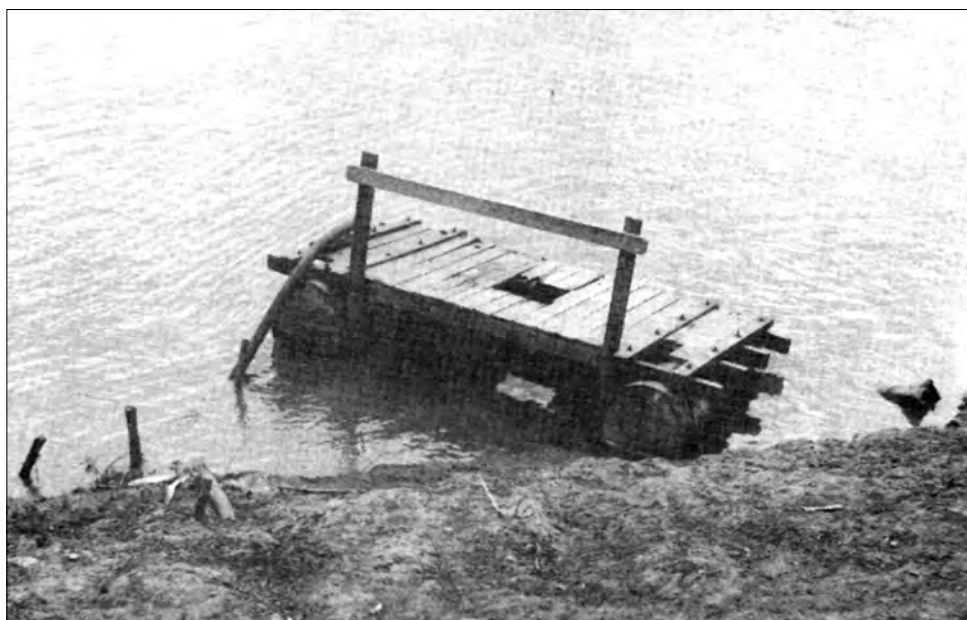

Figure 3.36: Floating intake⁶⁹²

The new construction works included a new weir intake, new treatment plant, new pumping lines, new reservoirs and augmentation of existing pipelines and reservoirs. The design population of the scheme was 15,000 in the year 1995, and the ultimate demand was estimated to be 3850 m³ per day.

691 Procter R.A.W (1925). Conservancy in Fort Hall Township. Kenya National Archives, BY/29/26, Ref: San. 682/1. 18th August 1925.

692 Hunn G (1983). Progress Report about Water Projects Included in the Minor Urban Water Supply Programme. NORAD, Nairobi.

By 1983, water supplies had improved significantly, figure 3.37 illustrates an intake weir washed away by the rains.



Figure 3.37: Intake weir washed away by the rains in 1983⁶⁹³

The existing stage was constructed for 2570 m³ per day but the treatment could be easily extended. Water was supplied by gravity to the treatment works. Aluminium sulphate and soda ash (Natrium Sulphate) were added in the mixing chamber prior to the flocculation, water then passed through the sedimentation tank and the rapid sand filter before reaching the clear water tank where chlorine was added. The existing production at 1500 m³ per day was sufficient to operate the scheme for 15 hours a day. There were no water Kiosks or communal water points at Murang'a water supply, and water was connected through 1500 individual connections⁶⁹⁴. The visit on 15th January 1983 revealed a completely flushed away intake, blocked intake line, un-operational three in every four stirring pumps, and a third of electric chemical pumps not working (figure 3.38). The estimated cost for repair was KES 500000.

693 Hunn G (1983). Progress Report about Water Projects Included in the Minor Urban Water Supply Programme. NORAD, Nairobi.

694 Hunn G (1983). Progress Report About water Projects included in the Minor Urban Water Supply Programme. NORAD –Coordinator/MOWD. Nairobi Ref: WD/1/2/5. 10th June 1983.



Figure 3.38: A Surge vessel (not working for fourteen months due the breaking down of the compressor 1983⁶⁹⁵.

Kahuro Water Supply: Kahuro market by 1983 was the divisional Headquarters for Kiharu Division, Murang'a district, central province. The Kahuro water supply was designed by the Ministry departmental Design section and construction was done by direct labour section. The scheme was completed by directed labour and commissioned in February 1978 at a construction cost of KES 748,000. The population for Kahuro for 1975 and the projections of 1985 and 1995 was 550, 900, 1450 respectively demanding 60 m³ per day, 100 m³ per day and 220 m³ per day respectively of water. The MUWS scheme involved intake weir built across Muriuriu River, one staff house, clear water storage tank 45 m³, low lift pumping line, high lift pump line and distribution lines⁶⁹⁶.

A visit to the site indicated that an engine for low lift pump and another one for high lift pump were out of operation, the sedimentation basin which was installed to take care of silt in the river, had been used as a full treatment plant with chemicals which was contrary to the designs,- this caused corrosion of the steel. The water was too silty; to avoid use of chemicals, aluminium sulphate, chlorine and soda ash were added to the inlet tank. By 1983, there were 75 individual 75

695 Hunn G (1983). Progress Report about Water Projects Included in the Minor Urban Water Supply Programme. NORAD, Nairobi.

696 Hunn G (1983). Progress Report about Water Projects Included in the Minor Urban Water Supply Programme. NORAD, Nairobi.

connections to the scheme and no communal water points or water Kiosks. Electric pumps, due to availability of electricity by 1983 were proposed for the new scheme. The sedimentation unit was expected to collapse within a short time and a new treatment plant was required⁶⁹⁷.

Limuru Water Supply: Limuru Township, located approximately 33km North West of Nairobi in Kiambu district, central province. In 1983, Limuru urban water supply consisted of an augmentation of the existing water supply in the township, as well as construction of a separate scheme in Limuru uplands. The combined projects were designed to cater for a projected population of 5500 persons in 1985 and 13000 in 2000. It was estimated that approximately 550 private connections would serve the consumers when the scheme was completed. The construction works included the MUWS programme for Limuru water supply. Figure 3.39 is an illustration of Bathi dam pausing hazard to both plants and animals.



Figure 3.39: Overflowed Bathi Dam in 1983⁶⁹⁸.

The old Limuru water supply was augmented through drilling and equipping new four boreholes, construction of two new storage tanks at treatment sites, construction

697 Hunn G (1983). Progress Report about Water Projects Included in the Minor Urban Water Supply Programme. NORAD, Nairobi.

698 Hunn G (1983). Progress Report about Water Projects Included in the Minor Urban Water Supply Programme. NORAD –Coordinator/MOWD. Nairobi Ref: WD/1/2/5. 10th June 1983.

of a utility building including chemical room and rising main and distribution lines. A new separate scheme at Limuru uplands was also construction which involved drilling and equipping of four boreholes, supply of electricity to the borehole site, construction of utility building and storage tanks with chlorination equipment and rising main and distribution lines. Utility building of Limuru water supply is illustrated in figure 3.40



Figure 3.40: Utility building, two storage tanks, aerator and electricity supply for Limuru water supply in 1983⁶⁹⁹.

The consultant for the project was Chauhan Kiptoon and Partners, Kundan Singh construction was responsible for civil works, while Wigglesworth and Co was responsible for electromechanical installations. Limuru water project was somewhat complicated since it involved a total of five projects i.e. old Limuru water supply, the augmentation of Limuru water supply, Limuru Uplands, old Bathi water supply and Bathi water supply⁷⁰⁰.

The construction process was “extremely slow’ due to lack of funds. Most of the civil works were completed and the remaining by April 1983 was estimated to cost KES 2.5 million. Completion was expected on October the same year.

699 Hunn G (1983). Progress Report about Water Projects Included in the Minor Urban Water Supply Programme. NORAD –Coordinator/MOWD. Nairobi Ref: WD/1/2/5. 10th June 1983.

700 Hunn G (1983). Progress Report about Water Projects Included in the Minor Urban Water Supply Programme. NORAD –Coordinator/MOWD. Nairobi Ref: WD/1/2/5. 10th June 1983.

Ol Joro Orok Water Supply: Ol Joro Orok was a rural centre and a divisional headquarters in Nyandarua district by 1983. It is situated 185km north-northwest of Nairobi. There is a trading centre, Kangui, five kilometres southwest of Ol Joro Orok and the original intention was to supply the two centres and the rural area between with water from boreholes or from Oraimutia River. The supply area was however, increased several times during the design period and a far larger scheme than originally planned was being considered in 1983⁷⁰¹. Figure 3.41 and figure 3.42 illustrates Ol joro Orok Township and proposed dam site in 1983.



Figure 3.41: Ol Joro Orok centre as seen across the road in 1983⁷⁰²



Figure 3.42: Ol Joro Orok dam site proposed in 1983

Howard Humphreys and Sons (EA) were appointed as consultants for Ol Joro Orok MUWS in April 1975. The consultant was supposed to make specific proposals for

701 Hunn G (1983). Progress Report about Water Projects Included in the Minor Urban Water Supply Programme. NORAD –Coordinator/MOWD. Nairobi Ref: WD/1/2/5. 10th June 1983.

702 Hunn G (1983). Progress Report about Water Projects Included in the Minor Urban Water Supply Programme. NORAD –Coordinator/MOWD. Nairobi Ref: WD/1/2/5. 10th June 1983.

the actual limits of supply based on investigations of the demand and population. The final design report was submitted in February 1979 and tender documents prepared in March. The cost of the works was estimated at KES 20 million⁷⁰³. Population and demand projections for Ol Joro Orok between 1985 and 2005 are illustrated in Table 3.37.

Table 3.37: Population and water demand projection in Ol Joro Orok by 1985

Year	1985	1995	2005
Population	9066	13081	14409
Demand (m ³ per day)	980	1450	1760

3.3.2.7 Western Province Water Supplies

Kakamega Water Supply: Piped water supply had been installed in Kakamega before the start of World War II. The water supply became inadequate (especially during the dry seasons) in the years preceding, during and after the War. This situation prompted the Indian association to place petitions before the DC Kakamega for the augmentation of the water supply⁷⁰⁴.

Several residential plots had been sold on permanent leases and many proprietors were contemplating installing water borne sanitation. This however could not be done until a proper water supply was connected to the premises. Lack of water supply caused this delay⁷⁰⁵.

Request for a water supply to Kakamega was made by the Indian association through the secretary in his letter to the District Commissioner Kakamega. In the letter dated 20th August 1946, the matter of water supply to the township is forcefully brought out. The issue had been brought out earlier, before the World War II, and had been shelved during the war years, with promises that it would be dealt with first after the War. On 7th January 1947 the Indian Association sent another reminder to the DC Kakamega but this time a copy was also sent to their Legislative Council Representative Mr. A. Pritam⁷⁰⁶.

703 Hunn G (1983). Progress Report about Water Projects Included in the Minor Urban Water Supply Programme. NORAD –Coordinator/MOWD. Nairobi Ref: WD/1/2/5. 10th June 1983.

704 Colony and Protectorate of Kenya (1931 – 1950). Indian Association. Kenya National Archives, Ref No. PC/NZA/3/1/346, Nairobi Kenya.

705 Colonial Secretary, (1936). Township Ordinances (No.63 of 1930) Rules. Kenya National Archives, BY/21/98. 1936

706 Colony and Protectorate of Kenya (1931 – 1950). Indian Association. Kenya National Archives, Ref No. PC/NZA/3/1/346, Nairobi Kenya.

During the year 1947, the funds (4,136 pounds) which had been sanctioned in 1945 and 1947 expenditure were pulled together and expended on extensions to Kakamega water supply. The work which entailed installation of a new intake, chemical treatment plant, rising main and storage tank were installed. Provision for extension of the distribution system was also made in the 1947 draft estimates⁷⁰⁷.

Kakamega health centre had a full-scale water supply scheme by the ministry of works by 1961. Water was adequate to cover the recommended amount for bathing and the proposed water borne sanitation in the health centre. There were over 1,500 protected water supplies in Kakamega district and development was at the rate 190 supplies per year. Some homesteads in the North Wanga Housing Development Area contemplated installing a piped water supply from the protected supplies⁷⁰⁸.

The extension to the distribution system was not fully effected due to acute shortage of small diameter piping. This situation subsequently led to complains from the Indian community over shortage of water. Although water was available in the major mains it could not be channelled to the dwellings. The shortage persisted until 1949 when the small diameter pipes (3/4 inch) together with certain pipe connectors were made available.

While the township authorities were grappling with the problem of improving the distribution the demand for water was growing rapidly such that by the year 1951 the consumption had outgrown the sources of supply necessitating the need for a new treatment and pumping plant. Water was obtained from the Isioko (Isiukhu) River.

The construction proceeded steadily up to 1954 when it was inspected by Mr. Squires, the Hydraulic engineer. The water supply started operating in January 1955⁷⁰⁹. The supply had three partly separate treatment works. They were identified as the old treatment plant, the new treatment plant and the Struja unit. Kakamega water supply was owned by National Water Conservation and Pipeline Corporation⁷¹⁰.

By 1983, Kakamega was an urban centre and had since 1976 been the provincial headquarters for western province. It is located 394km Northwest of Nairobi and 1550masl. Kakamega had experienced growth since 1960's and water shortage was a common occurrence even though by 1983, the scheme had been augmented.

707 Colony and Protectorate of Kenya (1931 – 1950). Indian Association. Kenya National Archives, Ref No. PC/NZA/3/1/346, Nairobi Kenya.

708 Cort J.L, (1961). Safari Report: Provincial Health Inspector North Nyanza District, 18th to 21st July 1961. Kenya National Archives, DC/KMG/2/24/24, Ref: PHI/RP/3/61/70. 16th August 1961.

709 Colony and Protectorate of Kenya (1931 – 1950). Indian Association. Kenya National Archives, Ref No. PC/NZA/3/1/346, Nairobi Kenya.

710 Ministry of Water Development, Kenya and Ministry of Foreign Affairs, Finland (1992). Kenya-Finland Western Water Supply Programme: operation and Maintenance Manual-Kakamega Water Supply. Volume 1. 1992.

Kakamega had a population of 26100, a daily demand of 2550 m³ and a projected population of 63800 in 1985 and a daily demand of 5100 m³.

The new treatment plant had a capacity of 45m³ per hour, pumping station for low and high lift pumps, intake on Isiukhu River (figure 3.44), rising main, storage tanks with a total volume of 1570m³, reticulation system, store, office and staff houses. The augmentation works included the MUWS-programme and was divided into two phases, phase one cost was 3.6 Million KES while phase two cost was 2.5million KES⁷¹¹. Figure 3.43 demonstrates a clear water pumping flow diagram⁷¹²

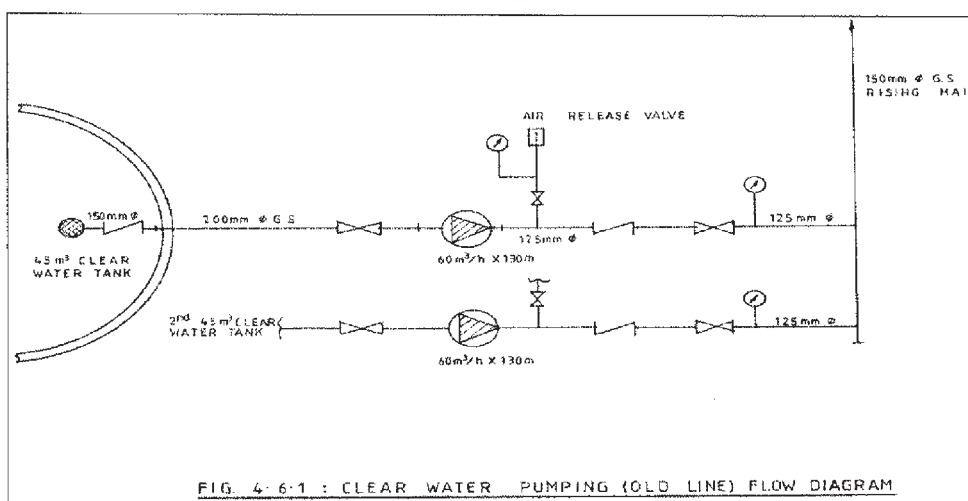

Figure 3.43: Clear water pumping flow diagram, the old line

The electric system comprised of 3-phase KP&LC transformer within the water supply site supplying the main distribution board at the power house. The main distribution board included KWH, KVA and KAVr metres and cut outs, main switches controlling supply to old pump use panel. Electronic water level sensor was mounted on the clear water sump while, its panel and warning sirens was in the staff room⁷¹³.

711 Hunn G (1983). Progress Report about Water Projects Included in the Minor Urban Water Supply Programme. NORAD, Nairobi.

712 Ministry of Water Development, Kenya and Ministry of Foreign Affairs, Finland (1992). Kenya -Finland Western Water Supply Programme: operation and Maintenance Manual-Kakamega Water Supply. Volume 1. 1992.

713 Ministry of Water Development, Kenya and Ministry of Foreign Affairs, Finland (1992). Kenya -Finland Western Water Supply Programme: operation and Maintenance Manual-Kakamega Water Supply. Volume 1. 1992.



Figure 3.44: Intake structure and low lift pumping⁷¹⁴.

One of major challenge was poor electrical system occasioned by the content of the electric control panel that had been removed from the cabinet and frequent problems caused by lightning. The electric motors, and electrical chemical pumps failed frequently. The capacity of the treatment plant was inadequate and despite 24 hours of pumping and the demand could not be satisfied⁷¹⁵.

Bungoma Water Supply: The Bungoma station was opened in 1949 as a substation. It consisted initially of a hospital and various departmental houses including that of a district officer. It was separate from the trading centre of the same name. Between 1949 and 1955, the station grew very rapidly. The greater part of the development was carried out by the African District Council. The development was so speedy it was decided to include all the land originally set apart for trading centre and railway station into one township. A notice regularising this was then published in the official gazette⁷¹⁶. The creation of an administrative centre at Bungoma necessitated

714 Hunn G (1983). Progress Report about Water Projects Included in the Minor Urban Water Supply Programme. NORAD, Nairobi.

715 Hunn G (1983). Progress Report about Water Projects Included in the Minor Urban Water Supply Programme. NORAD, Nairobi.

716 Williams C.H (1955). Bungoma Township: Main Drainage Scheme. Kenya National Archives, PC/NZA/3/25/43. Ref: LG/1/1/1/2/160. 6th June 1955.

the provision of an adequate water supply. The railway administration derived their water from the Bungoma River, and had agreed to supply the hospital and police lines with water surplus to requirements up to a maximum of 22.7 m³ per day. However, in 1951 extremely low flows in the river were experienced and no surplus water was available to the railway, compelling the administration to cut off supply⁷¹⁷.

The question of providing water for Bungoma Township started taking a defined shape in 1950. At this time the township had not been allocated priority to this scheme. The Water Resources Authority was responsible for allocating priority to schemes that had been proposed for construction. Priority A was given to the most urgent, B for those to be put under investigation and C to those with least importance⁷¹⁸.

In 1951 Bungoma water supply was given Priority A for construction, and a borehole yielding 2.7 m³ per hour was completed early in the year. The borehole had not been equipped with pump and reticulation. A second borehole was also envisaged. The cost of pump and reticulation was estimated at 3,000 pounds.

The hospital was to draw water from the supply hence urgent requests were made to the Development and Reconstruction Authority (D.A.R.A) to make provision for funds. The daily consumption was estimated to be 27.3 m³ per day, rising to 36.4m³ per day at full development⁷¹⁹.

The estimated cost of the project was 3,466 pounds including drilling, equipping, elevated storage, reticulation and DARA charges. The cost of O&M was estimated at 250 and 275 pounds per annum for consumption rates of 27.3m³ and 36.4m³ per day respectively. The contribution to a renewals fund at 3% of actual cost was 50 pounds, while the Total standing charges including interest on capital at 3% was calculated at 404 and 429 pounds for consumptions of 27.3m³ and 36.4m³ per day respectively. The expected revenue was 336 pounds for consumption of 6,000 pounds and 404 pounds if the consumption were to increase to 364 m³ per day⁷²⁰.

A second borehole was drilled and equipped in 1955 to supplement the first which had already been put in place. The new water supply for Bungoma consisted of a pumping plant in a new borehole, rising main, tank, chemical dosing plant, operator's quarters and supervision. The total cost was 3,000 pounds.

717 Colony and Protectorate of Kenya (1956). Medical Department, Bungoma sanitation and conservancy/ Bungoma water supply. Kenya National Archives, Ref. No. BY/29/50, Nairobi, Kenya.

718 Colony and Protectorate of Kenya, (1956). Medical Department, Bungoma sanitation and conservancy/ Bungoma Water Supply. Kenya National Archives, Ref. No. BY/29/50, Nairobi, Kenya.

719 Colony and Protectorate of Kenya, (1956). Medical Department, Bungoma sanitation and conservancy/ Bungoma Water Supply. Kenya National Archives, Ref. No. BY/29/50, Nairobi, Kenya.

720 Colony and Protectorate of Kenya, (1956). Medical Department, Bungoma sanitation and conservancy/ Bungoma Water Supply. Kenya National Archives, Ref. No. BY/29/50, Nairobi, Kenya.

In 1957, two boreholes supplied water in Bungoma. There were intentions to ban all watering of gardens, washing of cars and other vehicles and any other non-domestic use of water other than actual building connections. Building from an existing domestic connection was not supposed to be allowed without prior approval. Gardener, the divisional engineer warned all holders of building connections that disconnection could be effected in case of shortage due to breakdown of mains or plant, due to dry weather or other causes. Conversion to water borne sanitation was not allowed. Water borne sanitation scheme was an enormous development that was expected to outrun the supply and the development of another borehole was essential⁷²¹. The existing water supply was 93 m³ per day⁷²².

The provincial medical officer, Nyanza, observed that if there were no financial limitations, the ideal programme was to tap the Kuja and Nzoia rivers for Kisii and Bungoma respectively and to develop the sewerage schemes for both townships to serve a maximum amount of expansion likely to occur in near future. A possible alternative was to lay down the sewers and to install purification plants in anticipation of water supplies being developed later. This was not desirable because a sewerage rate for the repayment of the grant could have been imposed until the system was put into operation⁷²³.

By 1958, the water supply was already at strain and plans to augment it were on hand. The proposal to attract minor industries was considered unwise in the light of the difficulty in finding sufficient sources of water. The existing water supplies at the time were considered sufficient for consumption and “natural” increases i.e. industrial development was considered as an “unnatural” increase in water requirement⁷²⁴.

The provision for water at Bungoma became a game of push and pull with other consideration coming into play. The Yala as well as the Broderick falls (Webuye) water supplies was also at hand and it was a matter of priority and merit as to which water supply was most urgent, economical and cost effective. The then Provincial Commissioner Mr. Taiti preferred the development of Yala to Bungoma although his reason was that development of Bungoma water supply would cost more (40,000 to 50,000 pounds) compared to Yala (20,000 pounds).

In lieu of such biasness, it was thought wise that the matter be left to the Chief Hydraulic Engineer for investigation. The Chief Hydraulic Engineer confirmed that

721 Gardener D.G, (1957). Bungoma Water Supply Augmentation. Kenya National Archives, BY/29/50. Ref: 21/1//136. 31st May 1957.

722 Medical Officer of Health Elgon Nyanza, (1957). Bungoma: Sanitation and Conservancy. Kenya National Archives, BY/29/44. Ref: SN/8/37/13. 6th July 1957.

723 Provincial Medical Office, Nyanza (1957). Township Sewerage Schemes. Kenya National Archives, BY/29/44, Ref: SN/1/57/194. 26th August 1957.

724 Colony and protectorate of Kenya (1956). Medical Department, Bungoma sanitation and conservancy/ Bungoma water supply. Kenya National Archives, Ref. No. BY/29/50, Nairobi, Kenya.

it would be cheaper to install an adequate water supply at Yala since, if Bungoma were to be developed as an industrial estate, it would be necessary to pipe water from a new source some 24 kilometres away at a minimum cost of 60,000 pounds⁷²⁵.

At the same time, Broderick falls was being considered for development in conjunction with a paper-pulping industry and that water would be much cheaper there than at either Yala or Bungoma. It was thus felt that Broderick falls would be most suitable for development⁷²⁶. In meeting of the Water Resources Authority held on 19th January 1959, with representatives of the Ministry of Commerce, Local Government, Health and Housing, the Ministry of African affairs in attendance, it was recommended that priority be given to Yala but before definite consideration was made by the ministry, consideration was to be given to Broderick falls.

Broderick falls appeared suitable for industrial development because there was ample water available, the township was on a railway line and only 24 kilometres from Bungoma and the site had been selected for a pulp and paper factory. Broderick falls also seemed suitable for serving the agricultural potential of the Mount Elgon area⁷²⁷.

By August 1959, the existing water supply for Bungoma was obtained from two boreholes capable of providing about 182 m³ per day if operated for sixteen hours per day. The consumption in the town was under 136 m³ per day. Work was in progress in 1958/59 year on augmentation of this supply by drilling and equipping of a further two boreholes. The work was expected to be complete by the financial year 1959/1960 and was expected to increase the capacity to a maximum of 364 m³ per day in peak periods. This was expected to open up industrial development in the district⁷²⁸.

In 1961, the existing water supply produced 273 m³ to 318 m³ a day. The consumption was approximately 182 m³ a day. Additional housing was expected to increase the consumption to about 227 m³ to 273 m³ a day. Any further development of the township entailed additional borehole, however, there were no funds⁷²⁹.

Augmentation of water supply: The new Bungoma water supply project was conceptualized in 1975 and was included in MUWS programme. In the same year the project was put under design. The scheme was to obtain its water from the

725 Colony and protectorate of Kenya (1956). Medical Department, Bungoma sanitation and conservancy/ Bungoma water supply. Kenya National Archives, Ref. No. BY/29/50, Nairobi, Kenya.

726 Colony and protectorate of Kenya (1956). Medical Department, Bungoma sanitation and conservancy/ Bungoma water supply. Kenya National Archives, Ref. No. BY/29/50, Nairobi, Kenya.

727 Colony and Protectorate of Kenya (1956). Medical Department, Bungoma sanitation and conservancy/ Bungoma Water Supply. Kenya National Archives, Ref. No. BY/29/50, Nairobi, Kenya.

728 Acting Chief Hydraulic Engineer (1959). Bungoma Water Supply. Kenya National Archives, BY/29/50, Ref: DW.445/19. 30th June 1959.

729 The Town Planning Adviser (1961). Bungoma Development Plan. Kenya National Archives, BY/21/129, Ref: 40/1562/28. 28th July 1961.

Kuywa River or from a dam on Chwele River. The water was to be pumped to a storage tank at Makutelo from where it was to be supplied by gravity to Bungoma Municipality. The construction started in July 1976 and completed in 1980. Before the new piped water supply system was commissioned in 1980, the distribution system used to be fed with water from six boreholes from within the supply area. The new system was connected to the existing system with minor rehabilitation. Two of the six boreholes were functioning and were equipped with submersible pumps⁷³⁰. The population target at the time was around 10,000 persons. By the year 1985 the water supply had a design capacity of 2200 m³. By the year 2001, the supply was extended to cover an area of 12km² and a population of about 50,000 people. The National Water Conservation and Pipeline ran the scheme which by then the capacity had been augmented to.

Nambale Water Supply: Nambale water supply is in Busia district of western province. The water supply consisted of 2 boreholes were sunk in 1953 sited at the divisional headquarters. The two boreholes were rehabilitated in 1988 to supply an area of 2.4km² and serve a population of 11000 people from a total daily production of 160 m³.

By the year 2001, the quality of water from the boreholes was good and no treatment was done. The operating agent was the MENR. The supply had a total distribution network of 5 km with a storage capacity of 62 cubic metres⁷³¹.

Mbale Market Water Supply: The matter of Mbale water supply started in 1951, when it was proposed to draw water from the Edzawa River and for about three years remained in the hands of a Mr Gamble. The work in digging the trench for the pipeline started in the same year but was abandoned before any laying of pipe work could begin. The abandonment was to pave way an investigation into the realisation that water could be drawn from the Zimbari springs as opposed to the Edzawa River. Mr. Gamble did not involve the administration during the conceptualisation of the project⁷³².

730 The World Bank WSP – EASA (2001). The Development of the National Policy on Environmental Sanitation and Hygiene: A Situation Analysis on the Legal, Institutional and Resource Mobilization Frameworks Affecting the Environmental Sanitation and Hygiene (ESH) Sub-Sector in Kenya. Draft report.

731 The World Bank WSP – EASA (2001). The Development of the National Policy on Environmental Sanitation and Hygiene: A Situation Analysis on the Legal, Institutional and Resource Mobilization Frameworks Affecting the Environmental Sanitation and Hygiene (ESH) Sub-Sector in Kenya. Draft report.

732 Colony and Protectorate of Kenya (1954 – 1965). Mbale Market water supply. Kenya National Archives, Ref. No. DC/KMG/2/26/35, Nairobi Kenya.

Later in 1954, the then DC took up the issue of water supply to the Mbale market. The move had been necessitated by the development of a large market, shopping centre and considerable populations that patronized the market on weekends. Subsequently the DC Kakamega, on 17th January 1956 wrote to the Executive engineer ALDEV, requesting for an investigation into the matter of water supply. A rough investigation was carried out in February of the same year. The investigation covered water demand, sources and the various methods of abstraction⁷³³.

In 1956, the daily consumption at Mbale was estimated at 57 m³ per day, based on a population of 2,500 within Mbale market and an area of 2.5 km² around Mbale market. The consumption per head was put at 22.7 litres per head per day. Taking into account possible expansion of the market in future it was estimated the water supplied would have to be 11.4 litres per day. To cope with influx of people into Mbale Market on every market day it was proposed that a 45.5 m³ tank be installed at the market.

The spring had been well protected and was located 610 metres from the Market and 41 metres below, it would require a 45.5 m³ tank at the spring to act as storage for night flows and a sump for pumping during the day. However this source would only provide for the minimum requirements of the market. Another tank would then be required at the market for storage and use during market days⁷³⁴.

The Edzawa would provide enough supply for both current and future needs. The place of abstraction was 2.4 kms away and 104 metres below Mbale Market. This option would mean construction of a weir across the river or further investigation to find a natural sump. Both scheme required pumping.

Finally three proposals were made for supply of water to Mbale Market, the summary of which are presented in Table 3.38.

Table 3.38: Proposed supply of water to Mbale Market by 1943

Proposed scheme	Water delivered(m ³)	Total Installation cost (KES)	Monthly running Costs (KES)
Scheme I- Zimbari springs	59	28,000	320
Scheme II- Edzawa River (a)	59	50,000	540
Scheme II- Edzawa River (b)	114	80,000	760

Out of the proposals outlined in the table above, two other options were possible. That, scheme I be implemented first followed by scheme IIa, which could also be

⁷³³ Colony and Protectorate of Kenya, (1954 – 1965). Mbale Market water supply. Kenya National Archives, Ref. No. DC/KMG/2/26/35, Nairobi Kenya.

⁷³⁴ Colony and protectorate of Kenya, (1943 – 1962). Butere Water Supply. Kenya National Archives, Ref. No. DC/KMG/2/26/44, Nairobi, Kenya.

upgraded if and when need arose to scheme IIb. The other option would be to just implement scheme IIb. The phased option would involve lower capital outlay (KES 78,000) as compared to scheme IIb (KES 80,000) but higher with running costs of KES 860 as compared to that of scheme IIb with KES 760. The above proposal was however not put into action as at 1965⁷³⁵.

Butere Water Supply: The water supply for Butere was first called for by eight Indians of Butere township in April 1943, through the medical officer of health North Kavirondo. There were two proposals for water supply; pumping from River Ferrazi and drilling of a borehole at the CMS mission. The Borehole was preferred due to cost and the safety of the water obtained. The dire need for water at Butere was further stressed in 1946 when the public at Butere petitioned the District Commissioner in Kakamega on the same issue of water provision⁷³⁶.

In 1950 the issue of Butere water supply was revisited, the traders were scared of the cost of piping and pumping water from a river a distance of two and half kilometres away and paying highly for its maintenance and preferred financing their own small self-contained system involving a dug well. The Asians in particular were loath to paying rental charges to the African district council for piped water supply.

Despite the hindrances, the population of Butere trading centre was estimated at 120 people with water demand of 2.3 m³ at minimum and 4.5 m³ at maximum. Nothing in terms of tangible water development was initiated even after the discussion and deliberations⁷³⁷.

Later in 1957 two water supply system were considered by the Health inspector i.e. the ram and a borehole, the cost of which was 870 and 936 pounds respectively. Two proposals were forwarded; first the traders were prepared to advance 200 pounds towards the water project and it was hoped that the African district council would step in to help with more funds while the government would complete the rest, secondly the traders proposed the formation of a company to finance the whole project and thereafter levy charges to whoever wished to draw water from the system⁷³⁸.

While the Indian traders were grappling with the issue of water provision the CMS mission went on to drill a borehole for the mission, girls' school and the Chadwick teacher training centre. The yield of the borehole was good enough to

735 Colony and protectorate of Kenya, (1943-1962). Butere Water Supply. Kenya National Archives, Ref. No. DC/KMG/2/26/44, Nairobi, Kenya.

736 Colony and Protectorate of Kenya, (1943-1962). Butere Water Supply. Kenya National Archives, Ref. No. DC/KMG/2/26/44, Nairobi Kenya.

737 Colony and Protectorate of Kenya, (1943-1962). Butere Water Supply. Kenya National Archives, Ref. No. DC/KMG/2/26/44, Nairobi Kenya.

738 Colony and Protectorate of Kenya, (1943-1962). Butere Water Supply. Kenya National Archives, Ref. No. DC/KMG/2/26/44, Nairobi Kenya.

allow supply to the Health centre. It is not clear whether the borehole was built by fund from the government but it was being operated and maintained by the mission with funds from the ministry of education⁷³⁹.

In 1959, a small administrative substation was preferred at Butere, in addition staff quarters were to be built, and trading centres to be supplied with water and finally the railway station. This inevitably meant a further borehole would have to be drilled and the consequent supply would be sufficient to be gazetted as a public supply to be operated by either the MoW or the ADC. The administrative substation was abandoned and so was the drilling of the new borehole which was to serve the anticipated increased needs for water had the substation been put up.

However in a few years down the line the substation grew with the inclusion of DO's House, Chiefs Centre, Posts Office, Detention camp as well as one or two inhabited houses. The water to these government institutions was unsatisfactory because water had to be carted from some distance away or from the college borehole which was already supplying the Health centre. The borehole at the time was barely keeping up with the college's own needs.

In lieu of the above it was advisable for the government adopt any of the following measures; drill a second borehole to cater for the increased needs of the substation, increase the pumping hours, replace the pump with a higher capacity tank or change the cylinder at the bottom of the hole to allow for greater delivery. This needed to be accompanied by whole day storage to cater for the needs of the substation⁷⁴⁰.

Webuye Water Supply: Webuye is located in Bungoma district of western province. The water supply supplied an area of 69 km² with a population of 38,218 by the year 2001 and comprised of a pumping scheme with its source at Broderick Falls in Trans Nzoia River. The water supply served mainly Webuye town and a supply area of 27km². The supply scheme was commissioned in 1973 though several rehabilitation had been carried out since then.

The Webuye water supply was operated by the water department of the ministry of environment and natural resources. The water production was 1800 m³/day by the year 2001. This amount of water was below demand and was under expansion in 2001. After completion, the scheme had a total storage capacity of 1200m³ and a distribution network of 21km. The intake works was the falls that act as natural weir, valve chamber, inlet chamber and a bar screen. The scheme has a conventional treatment system and Struja system (Figure 3.45).The pumping system had two

739 Colony and Protectorate of Kenya, (1943-1962). Butere Water Supply. Kenya National Archives, Ref. No. DC/KMG/2/26/44, Nairobi Kenya.

740 Colony and Protectorate of Kenya, (1943-1962). Butere Water Supply. Kenya. National Archives, Ref. No. DC/KMG/2/26/44, Nairobi Kenya.

pumps. The two treatment lines shared the same intake works, raw water main, division box, clear water tank, rising main and backwash tank⁷⁴¹.

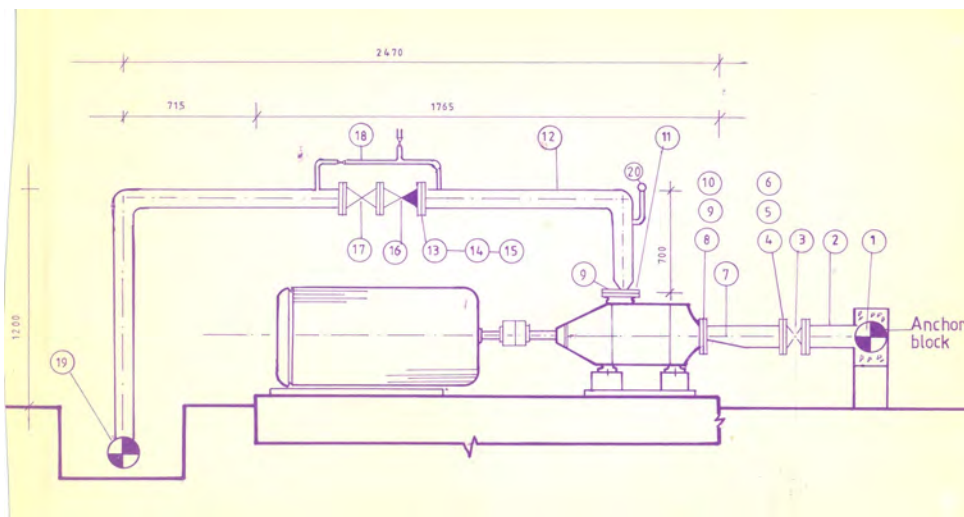

Figure 3.45: Struja treatment plant⁷⁴².

The Struja process: the plant was designed to produce portable water from raw water available mainly in surface water sources like rivers and lakes. The raw water was not expected to have been polluted by such unhealthy matters, which could not be removed by normal coagulation/disinfection process. The maximum gross quantity of the raw water needed was 480 cubic metres per day or Struja 400 unit. The quantity depended on the composition of the actual raw water. The purified water was expected to meet the normal requirements of potable water provided that the operation and maintenance of the plant was careful and met the instructions given during the plant delivery⁷⁴³.

Ramisi Sugar Factory Water Supply: By 1960, water supply for the Ramisi Sugar Factory hospital consisted of stand pipe situated near the main outpatient block. The water from stand pipe ran out into onto two 200litre drums sunk in the ground from

⁷⁴¹ The World Bank WSP – EASA, (2001). The Development of the National Policy on Environmental Sanitation and Hygiene: A Situation Analysis on the Legal, Institutional and Resource Mobilization Frameworks Affecting the Environmental Sanitation and Hygiene (ESH) Sub-Sector in Kenya. Draft report.

⁷⁴² Ministry of Water Development, Kenya and Ministry of Foreign Affairs, Finland (1992). Kenya Finland water Supply Programme: Operation& Maintenance Manual-Webuye Water Supply. 1992.

⁷⁴³ Ministry of Water Development, Kenya and Ministry of Foreign Affairs, Finland (1992). Kenya Finland water Supply Programme: Operation& Maintenance Manual-Webuye water Supply. 1992.

which it was lifted out and carried to where it was required. The hot water system depended on water being lifted out of these drum and poured into another raised drum nearly beside the wall of the outpatient block in which it could be heated. The hot water was therefore supplied by gravity. The labour complained about their food, water supplies, lavatories, bed bugs and mosquitoes, but admitted that their health was good on whole⁷⁴⁴.

Water in the factory was obtained from shallow wells. Most of them were well situated and protected by steining and parapet walls. It was proposed they be improved by provision of pumps, storage and systems of distribution within the camps.

Kitale Water Supply: The need for water supply in Kitale was recognized as early as 1930 when the assistant water engineer and medical officer of Health, Eldoret and other stakeholders of Kitale Township Committee held a meeting to discuss the water situation in Kitale Township. They resolved to draw attention to the government to complete boring experiments within the town before any other work was carried out. Figure 3.46 illustrates the population of Kitale Township in 1930⁷⁴⁵.

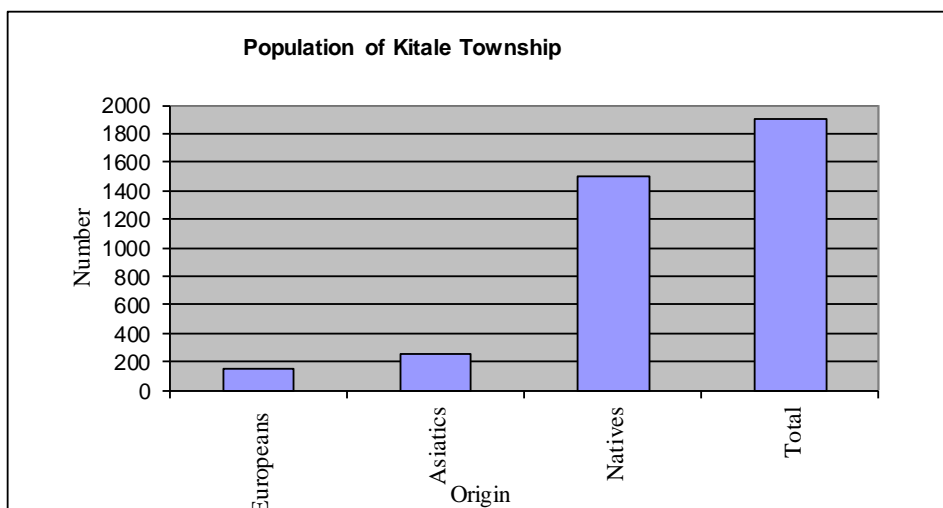

Figure 3.46: Population of Kitale by 1926⁷⁴⁶

744 Medical Officer of Health, Kwale District, (1960). Medical and Health Facilities: Messrs. Kenya Sugar Estates, Ramisi. Report by Medical Officer of Health, Kwale District. Kenya National Archives, BY/44/6. 21st November 1960.

745 District Commissioner, Kitale, (1930). Minute V: Water Supply. Kenya National Archives, DC/KIT/1/5/3, 2nd of April 1930.

746 Health Officer (1927). Kitale. Kenya National Archives, BY/21/195, Ref: N.T.6/3. 26th May 1927.

The Kitale Township water supply was completed in March 1931 and connections to European residents began. Immediately, a problem on how to deal with the existing railway supply arose. The general manager, Railways, argued that the government, medical department, the public works department and everybody else was satisfied with the completed government supply. After consultation with the government, the Railway management agreed that the Municipal supply was satisfactory and agreed to connect its distribution system to the Municipal system⁷⁴⁷.

The issue of water charges also arose and the Kitale township committee requested the government to reconsider the minimum charges to 3 shillings per 13.6 m³, plus 3 shillings as service charge. This charge appeared low but the committee felt that due to anticipated bulk connections, harmonizing the charges would increase the revenue by 700 shillings per month. The medical officer of health was ready to take the necessary action to ensure that all residential plots were connected to the Kitale water supply soonest by 1932⁷⁴⁸. In order to enforce utilisation, the director of medical and sanitary services suggested that a specific bylaw be prepared requiring the owners of all premises laid within a reasonable distance to make use of the town water supply⁷⁴⁹.

Establishment of Municipality of Kitale: The standing committee for local government in rural areas in May 1947 considered a report from the commissioner of local government for establishment of a municipality at Kitale. The committee approved the submission of the report to the governor in council with supporting recommendations as follows:

- The government should make a consolidated recurrent grant of 3,000 pounds per annum for a period of years.
- A capital endowment grant of 2,000 pounds should be made together with all the plant and tools used for township purposes and the government African housing in the occupation of the staff employed on township affairs.
- The government should meet the cost of compiling the first valuation roll.
- The effective date for establishment should be 1st of January 1948.

⁷⁴⁷ Director, medical and sanitary services (1932). Letter to the Colonial Secretary Suggesting Ways to Utilize the Kitale Township Water supply. Kenya National Archives, DC/KIT/1/5/3. 13th October 1932.

⁷⁴⁸ Connolly P.D (1932). Kitale Water Supply. Kenya National Archives, DC/KIT/1/5/3, Ref: E/14/38, 2nd September 1932.

⁷⁴⁹ Director, Medical and Sanitary Services (1932). Letter to the Colonial Secretary Suggesting Ways to Utilize the Kitale Township Water Supply. Kenya National Archives, DC/KIT/1/5/3. 13th October 1932.

The commissioner for Local Government approved the recommendations and in addition insisted that a special vote to the public works department for roads and drains should be handed over to the municipality. However, the director of public works was not ready to hand over the funds in consideration of posting of an assistant engineer to Kitale and the capital endowment grant of 3,000 pounds⁷⁵⁰.

In January 1948, the governor abolished and disestablished the township of Kitale through powers conferred upon him by section 5 of the township ordinance, 1930. Consequently, he constituted a municipal board for the Municipality of Kitale (under section 11 of ordinance, 1928) and appointed a municipal board consisting of the following:

- The district commissioner of Kitale District to be the Chairman.
- Two members representing the government of the colony and the Kenya Uganda Railways and Harbours Administration to be nominated.
- Six European members, three Indian Members Two African Members and one representative of the Trans-Nzoia District council, to be nominated⁷⁵¹

Kitale Municipal Water supply was first commissioned in 1953 with its intake at River Koitobos, 6 km North East of Kitale Town. By then the water supply had a production capacity of 125 m³/h. This capacity was not sufficient to cater for the rapidly growing Kitale town's urban population. In 1982 another intake on river Nzoia, 14 km south of the town centre was commissioned with a production capacity of 430 m³/h

By 1980, Kitale obtained water from Koitobos River with a draw off works located roughly six kilometres north of town. Low lift pumps transmitted the water to treatment works about 400m from the bank of the river. After passing through sedimentation and rapid gravity filters, the water was fed by 225 m³ storage tank where it was disinfected with gaseous chlorine. A High lift pump drew from this tank through 300mm diameter steel mains. In 1977/78, extensions to the works were completed, new pumps installed and standby generator provided, with the result that the supply was equivalent to the estimated demand from Kitale. The new works had provision for expansion in 1990 to meet long-term demands⁷⁵².

750 Commissioner for Local Government (1947). Establishment of a Municipality for Kitale. Kenya National Archives, PC/NKU/2/19/26, L.G.662/148. 19th May 1947.

751 Township Ordinance of 1930 Proclamation Number 61 and the Local Government (Municipalities) Ordinance of 1928 proclamation Number 62.

752 Waweru and Associates and Rofe Kennard and Lapworth Terrapian Kenya (1980). Third Urban Housing Project Interim Report No. 1 Volume A: The Towns. Republic of Kenya, Ministry of Housing and Urban Development.

By the year 2001, the Koitobos intake served the Northern section of the distribution system while the Nzoia intake served the southern. The scheme served a population of 60,000 people covering an area of 91km². It was producing a total of 14925m³/day with a total storage capacity of 9,907m³. Operation and maintenance was carried out by Kitale Water Company.

The rising mains (pumping and gravity) covered 2km and the distribution network of 130 km. The scheme had a conventional treatment system⁷⁵³.

Water Supply for African Staff: There was a very wide variation in the arrangements for the supply of water to Government African staff in the various stations in 1948. Municipal water supplies existed in Nairobi, Kisumu, Nakuru and Eldoret, while the Public Works Department supplies were available in Mombasa and a large number of other stations⁷⁵⁴. These supplies delivered a piped supply of water to the towns and then water was supplied to Government African quarters by one of the following means⁷⁵⁵.

Taps in individual quarters. This arrangement was comparative.

A water kiosk, which consisted of a battery of taps in a cage, which was capable of being locked. The kiosk was operated by an African employed by either the Municipality or Public Works Department, his duty was to supervise the delivery of water⁷⁵⁶.

Standpipes for a group of Government quarters, it appeared that the standpipes were normally under the supervision of any Municipal or Public Works Department employee, but to prevent wastage of water they were locked for certain parts of the day⁷⁵⁷.

In a number of remoter stations, there was no piped water and the Government African employees obtained their water from wells, dams, furrows or streams. While in some cases, water was brought by cart or other means of transport from a source distance from the station⁷⁵⁸.

753 The World Bank WSP – EASA, (2001). The Development of the National Policy on Environmental Sanitation and Hygiene: A Situation Analysis on the Legal, Institutional and Resource Mobilization Frameworks Affecting the Environmental Sanitation and Hygiene (ESH) Sub-Sector in Kenya. Draft report.

754 Hartwell C H, (1948). Water Supplies for African Staff. Kenya National Archives. BY/35/15, 26th, January 1948.

755 Hartwell C H, (1948). Water Supplies for African Staff. Kenya National Archives. BY/35/15, 26th, January 1948.

756 Hartwell C H, (1948). Water Supplies for African Staff. Kenya National Archives. BY/35/15, 26th, January 1948.

757 Hartwell C H, (1948). Water Supplies for African Staff. Kenya National Archives. BY/35/15, 26th, January 1948.

758 Hartwell C H, (1948). Water Supplies for African Staff. Kenya National Archives. BY/35/15, 26th, January 1948.

The payment for the water supplied to the African Government Employees was made to the Municipality or the Public Works Department by the Government Department concerned from the appropriate item of their estimates, usually the item “Electricity, Water and Conservancy” under the head other charges. In most of the cases water was supplied free of charge to the Africans occupying Government quarters, but the quantity supplied varied considerably. In some stations, the family of the employee was also supplied at Government expense. The quantity of water in some of the station varied considerably depending on the department to which the employee belonged. The reasons for this variation were not known and according to the opinion of the Labour Commissioner, it was a source of dissatisfaction to African employees of Government in certain station⁷⁵⁹.

It was reported that section 33 of the Employment of Servants Ordinance of 1938 read as follows:

‘Where an employer was required by the provision of his Ordinance to cause his servants to be housed or fed, he is to provide at the place of employment a sufficient supply of wholesome water for the use of such employees’.

The purpose of this section according to the Labour Commissioner was that it placed an obligation on employers of Africans on rate of pay less than 100/= shillings per month to provide them with free water. The Government was in support of this principle, and the arrangements in which African employees on 100 shillings per month or less occupying Government quarters received a free supply of water would continue⁷⁶⁰.

It was believed that it was impracticable to provide complete uniform water supply to African staff at various station throughout the territory. However, it was desirable to achieve as great degree of uniformity as was possible and in order for this to be achieved the following rules and principles were to be observed⁷⁶¹.

African employees living in Government quarters and receiving less than 100 shillings per month or less were to be provided with free water in reasonable quantities. Reasonable quantity depended on the quantity of water available in that particular station.

759 Hartwell C H, (1948). Water Supplies for African Staff. Kenya National Archives. BY/35/15, 26th, January 1948.

760 Hartwell C H, (1948). Water Supplies for African Staff. Kenya National Archives. BY/35/15, 26th, January 1948.

761 Hartwell C H, (1948). Water Supplies for African Staff. Kenya National Archives. BY/35/15, 26th, January 1948.

The construction and maintenance of a water supply cost a substantial amount of money, thus it was important to ensure that water was not wasted. Whenever, possible arrangements were to be made to ration water to those employees who received free, in order to ensure that only a reasonable quantity was used. Arrangements were also to be made to ensure that taps on standpipes were not left on so that water does not run to wastes.

African employees, who were provided with a piped supply and had individual tap in their quarters would, whenever practicable, be required to pay for the water, which they received according to the quantity they consumed. These were men who always earned 100 shillings per month or more, and they were believed to be few in number.

Employees who received more than 100 shillings or more per month and who did not have a an individual piped supply to their quarters were not required to pay for the water which they received, but arrangements required to be made to ensure that the water was not wasted.

The variety of the circumstances made it impossible to secure uniformity throughout the territory in regard to the quantity of water supplies in some stations it was plentiful, in others, it was scarce. However, in particular station it was desirable that all African employees were to be treated equally and were to receive water in equal quantities and on the same conditions. To ensure this, District Commissioners were to discuss the matter with local department representatives in order to secure such degree of co-ordination as was practicable.

Africans employees, whatever their rate of pay, who did not occupy Government quarters were to continue making their own arrangements for the supply of water.

3.3.2 Rural Water Supplies

Rural water supplies were started in 1948 with the aim of opening agricultural areas in the mainly European settled areas. The first rural water supplies project (Rongai pipeline) was started in 1948 with the aim of opening agriculture in the mainly European settled areas.

Several rural pipelines were envisaged, these included Rongai, Vissoi, Olabana, Westacre, Elburgon, Enarosura, Kinja and Kinangop ring main. All of these rural pipelines were in place and operating by the end of 1959. Although the above pipelines were the major ones initiated in the mainly European settled areas (with exception of Enarosura) other schemes ranging in number between 50 and 60 were

developed in African areas⁷⁶² where the tendency was to put in a greater number of schemes of smaller dimension. Such schemes included those designed to protect water catchments by conveying piped water supplies to grazing areas sufficiently remote from important catchments to afford them protection.

The rural piping schemes were executed and operated in different ways, depending on whether they were in the old “scheduled” areas or the “non-scheduled” areas. In the “scheduled” areas, they were financed by the Central Colonial Government and installed by the Hydraulic Branch in the Ministry of Public Works. However, according to the Water Development Department, most of the rural water supplies in the old scheduled areas ran into trouble as the European settlers sold their land to African farmers and left thus the association of operators broke down and these schemes ran into difficulties namely: (a) operation and maintenance; (b) management (repayment of loan, etc.); (c) sale of water under prevailing circumstances of settlement and changing ownership; and (d) physical collection of revenue. Rural water supply sometimes involved labour intensive methods (Figure 3.47) in pipe laying. Self-help groups contributed their labour to the construction of supplies by digging pipe trenches⁷⁶³.



Figure 3.47: Communal labour being used to provide water supply⁷⁶⁴.

762 East African Standard (1959). More water for Colonies Farms. Kenya National Archives, Ref: BV/14/420. Nairobi, Kenya.

763 Water Development Department (1965). A memorandum by the Director, Water Development Department, Ministry of Agriculture Animal Husbandry and Natural Resources. Kenya National Archives, Ref: BY/35/17. Nairobi, Kenya.

764 Water Development Department (1965). A memorandum by the Director, Water Development Department, Ministry of Agriculture Animal Husbandry and Natural Resources. Kenya National Archives, Ref: BY/35/17. Nairobi, Kenya.

In the late 1960s, the government of Kenya approached possible donors with the view to funding a rural water supply programme, which had two major aims. The first aim was to break water related development bottlenecks in the high potential areas and the second to provide potable water in areas of chronic drought. SIDA showed interest in funding this programme and the first of three credit agreements signed between the Governments of Kenya and Sweden was in 1970. Subsequently two more agreements were signed in 1972 and 1974 respectively. The third agreement ran up to 1978. The fourth phase of the programme had been prepared by 1976 and donors were being sought.

The details of the Swedish support are adequately covered in section 3.5, bilateral assistance programmes.

Rural aims and methods: Where sources were few, enhancement of water quality and its accessibility came first and provision of boreholes was important. However, it was clear from the number of unused yet fairly functional boreholes to be found that boreholes were not the general panacea they were sometimes assumed to be, and that local assessment of the best measures was always required. Acceptance of improvements could be impeded by the procedures and conflicts of government agencies as well as by the perceptions of local users. Therefore, National policy should be in terms of concrete goals, not methods. Suggestions were that the rural aspect of a national policy which sought to minimize the social cost of water supply might have these features:

For all rural communities, efforts would be made to provide all inhabitants with improved supplies offering up to 20 litres per capita with moderate contamination hazard at no reimbursable cost other than initial and continuing contributions of labour for constructions and maintenance and for transport from the source. The design minimum would depend upon the preferences and habitat of the people involved. So far as the rural population shows itself ready, over a reasonable period of repayment, to bear the whole cost of maintenance and some proportion of construction cost for simple piped schemes furnishing up to 40 litres per day with low hazard of contamination, these would be provided. Individual homeowners would be systematically encouraged to make independent improvements. These include individual cisterns, shallow wells, spring protection, water treatment devices, and method of handling water⁷⁶⁵.

⁷⁶⁵ Gilbert F. White, David J. Bradley and Anne U. White (1972). *Drawers of Water, Domestic Water Use in East Africa*. The University of Chicago Press Chicago and London, 1972.

The Swynnerton Plan and African Land Development (ALDEV): All the rural water development works carried out within 1955 and 1962 was under the plan. The plan was a government initiative under the district commissioner who collaborated with the African District Councils and the District executive committee. In 1955, the Nandi district commissioner cum the president of Swynnerton plan, Mr. P.H. Brown, issued a memorandum to all members of the Nandi district team. This was intended to guide the officers on the work to be carried out in the following one and a half years in implementation of the Swynnerton plan. This was the initial stage of implementation of the scheme, which involved most taxing work of developing the best methods to carry out the plan⁷⁶⁶.

The president conveniently divided the plan onto two parts to facilitate the staff works and vehicle use. Part one was concerned with the work done by the increased agricultural and veterinary staff; both European and African. Part two of the scheme discussed in depth the supervision, staff, large dams, other water, supplies, finance, accounting, survey and other works and loans⁷⁶⁷.

The construction of large dams was the responsibility of the soil conservation unit, at Eldoret under general supervision of the DC and the District Agricultural Officer. The remaining works consisting of stepping down rivers, weirs, small weirs, small dams, springs and wells in locations other than the ones under Mr. Matson jurisdiction were under Mr Scott's control. A provision was made in the plan for twenty large dams. The district agricultural officer in consultation with the chiefs and by the approval of the district Executive was responsible for siting them. The soil conservation unit with assistance of free communal labour for clearing, digging the core planting grass etc. was liable for the construction. A provision was made for each dam to be piped to adjacent cattle troughs under supervision of Mr. Scott or Mr Matson depending on the location. Seven large dams were expected to be completed by July 1956 and a water pipeline built at Chemase at a cost of one thousand pounds instead of a dam⁷⁶⁸.

As many as possible springs were proposed to be boxed in and piped. The land-owners within the holding where the spring sprung were responsible for payment of the cost of materials. However, free communal labour was expected to assist where necessary.

766 Brown.PH 1955. Swynnerton Plan. Kenya National Archives, DC/KAPT/2/1/33, Ref: AGR.11/5/3. 28th September 1955.

767 Brown.PH 1955. Swynnerton Plan. Kenya National Archives, DC/KAPT/2/1/33, Ref: AGR.11/5/3. 28th September 1955.

768 Brown.PH, 1955. Swynnerton Plan. Kenya National Archives, DC/KAPT/2/1/33, Ref: AGR.11/5/3. 28th September 1955.

Piped Water Supplies: The district Executive committee was unable to reach an agreement on piped water supplies and sought advice from the provincial commissioner, Rift Valley province. The executive expected to install piped water supplies to both farmers and locational centres. According to the proposal, rates were to be levied to cover maintenance etc. but the plot owners, government etc. were not supposed to provide anything towards the initial cost⁷⁶⁹.

On the other hand, the ADC was not in a position to undertake the responsibility because of its unfavourable financial position. ADC therefore proposed to urge the plot owners and other land users in locational centres to subscribe towards the initial cost. This would help in installation upon which water would be provided free for a given period equivalent to initial capital subscription. Mr Brown felt that the method was very slow, as the ADC would have to wait until the savings accumulated for that or seek for loan of which the ADC had a lot of unpaid loans⁷⁷⁰.

According to the President of Nandi African District Council cum the District Commissioner Mr. P.H brown, the approved Swynnerton plan for the district provided for the construction of 20 large dams by the soil conservation unit. One thousand pounds was provided for each dam to cover the cost of unit plus fencing, cattle troughs and piping. By April 1956, three such dams were already completed. Since the construction started, it was established that more large dams were still required especially in the eastern parts of the district. Water table was found at 18 metres and when it was struck the level rose to about 6 metres. This was shallow enough and made further digging less important. There were innumerable springs and tapering streams of permanent nature, which indicated that water, was adequate but not well harnessed for optimum use. This revelation prompted more action from the district executive committee. The unresolved problem was how to get water to the individual holding, which was the ultimate object of the exercise⁷⁷¹.

Funds for large dams had a third loan element while funds for small dams had three-seventh loan element. The DC felt that the district and the ADC should take advantage of the large grant.

The district executive wished to purchase a tractor for the scheme from the relevant vote to stop dependency on the soil conservation Unit Programme and

769 Brown P.H, (1956). Piped Water Supply-Swynnerton Plan. Kenya National Archives, DC/KAPT/2/1/33, Ref: AGR.11/5/3. 18th January 1956.

770 Brown P.H, (1956). Piped Water Supply-Swynnerton Plan. Kenya National Archives, DC/KAPT/2/1/33, Ref: AGR.11/5/3. 18th January 1956.

771 Brown P.H, (1956). Nandi District Swynnerton Plan. Kenya National Archives, DC/KAPT/2/1/33, Ref: AGR.11/5/3. 5th April 1956

could progress at the fastest rate possible. At the same time the committee would complete more water schemes to the increased benefit of Nandi⁷⁷²

A decision was made in 1956 to stop building dams and concentrate on piped water schemes. Consequently, there was a steady and uninterrupted progress throughout 1957. The organisation of the Swynnerton plan was divided into two parts.

The first part, under health officer, dealt with boxing in and piping of springs. Five hundred and forty eight schemes were completed in the year. About 5000 people, 6.25% of the population received clean water in the first year.

The second part of the organisation dealt with wells, rams, boreholes, pump heads, major schemes and experimental work. A summary of the achievement is in Table 3.39⁷⁷³.

The piped schemes mentioned in the table were constructed at Kilibwen, Mutwot, Kaiboi, Miti ya Hunter, Kabiyet, Kabiemit extension Mugunya (started in 1956) and two at Chemase. Farmers did a lot of private work in the efforts to augment the supplies. Table 3.39 illustrates the number of completed water projects in Nandi District in 1957.

Table 3.39: List of completed water projects in Nandi District in 1957

Units completed	Year		Total
	1955-56	1957	
Large dams	7	-	7
Small dams	79	8	87
Hand rig boreholes	68	50	118
Capped springs	208	548	756
Wells dug	19	92	111
Hand pumps on wells	11	17	28
Piped water schemes	3	8	11

The Swynnerton water work was very popular and the organisation could not meet the demand. It frequently happened that wells could not provide sufficient water for both human beings and the stock. In the efforts to augment, an experimental pump was tested to enable the wells go deeper. Windmills were also to be experimented to produce a cheaper one water source. In one year a 43,245 pounds loan was handed out to small scale farmers and 4420 pounds for individual large scale farmers. In addition, sixty eight thousand pounds loan Programme for the Swynnerton plan

772 Brown P.H, (1956). Nandi District Swynnerton Plan. Kenya National Archives, DC/KAPT/2/1/33, Ref: AGR.11/5/3. 5th April 1956

773 Annual Report-Nandi District (1957) to 1962 Kenya National Archives, DC/KPT/2/1/1. 1962

water supplies was requested. However, some difficulty was experienced in recovering short term loans advanced within the plan⁷⁷⁴.

In 1958, there was a steady and spectacular progress, half of the holdings in the district received a permanent water supply at a small cost. Much of these were due to existing water supply but largely because of the construction of boxed in springs of which 608 were constructed during the year. The total boxed in springs were 1445 and each of them commanded an average of some 100 acres.

Moreover, the construction of major water schemes continued and completed at Kilibwoni, where five kilometres piping was laid. At Kiboi, twenty holdings were supplied with piped supply. Sangalo, Malat, Mutwot, Kaptumo, Kabanter and Kaimoshi were being worked on⁷⁷⁵.

Work on construction of wells continued but with lesser emphasis than in the past. This was because the cost of an individual well was more than that of a piped supply. Besides, the time and effort involved in well construction was disproportionately large to that of constructing water schemes.

The collection of advances or short-term loans for water supplies in 1958 was not satisfactory. This was due to post-paid supply and the executive planned to institute a system where payments would be made in advance. Forty-five wells were dug and one hand-rigged borehole was completed. More works on hand-rigged boreholes was abandoned early in the year due to unavailability of information about well digging⁷⁷⁶.

By the end of 1958, no large dam or hand pump work was done. Nevertheless, the number of constructed structures within the year.

As it had been predicted, the organisation was unable to keep pace with the demand. This resulted to farmers grouping to purchase piping in order to link with the existing supplies. The government whenever possible gave assistance in laying the pipes and alignment.

The water rate per annum was 10 shillings per authorized user though the revenue was not collected on time. The African Development Council considered an increment to this rate to finance the second Swynnerton Scheme that required 68,000pounds.

In 1959, the progress of Swynnerton water supply scheme was slower than in 1958. This was because a financial appraisal was not ready and the ADC water supplies officer was away on leave for three months. At the same time, the health officer in charge of protecting springs work supervision was away on leave for six months⁷⁷⁷.

774 Annual Report-Nandi District (1957) to 1962 Kenya National Archives, DC/KPT/2/1/1. 1962.

775 Annual Report-Nandi District (1957) to 1962 Kenya National Archives, DC/KPT/2/1/1. 1962..

776 Annual Report-Nandi District (1957 to 1962) Kenya National Archives, DC/KPT/2/1/1. 1962

777 Annual Report-Nandi District (1957 to 1962) Kenya National Archives, DC/KPT/2/1/1. 1962.

The ADC could not service the loan, which prompted a reconsideration of financing the scheme. Furthermore, many Nandi's could not pay their share of cost, which made the reticulation from the main supply tanks slower. The authorities worked out and approved a new system of financing the scheme, which cut out the need to for the ADC to take the additional loans. In addition, the decision to allow individual beneficiary to spread his share of the cost over a period of five years was also passed.

The ADC water supervisor was unable to return to the district to complete his contract owing to his health. African Land Development, ALDEV, replaced him in the process of putting in the Lolkerigat piped water scheme. ALDEV also took up other various projects initiated by the sick supervisor. The principle was to keep the existing schemes in good running order and go ahead with minor additional schemes normally serving ten to twenty farms. The schemes were inexpensive and within the capacity of ADC technical staff especially. Reversion to major schemes was postponed to the time when sufficient Nandi ready and willing to pay the full cost would be available⁷⁷⁸.

Major works undertaken during the year were as follows:

- Diesel engines and pumps with storage tanks at Maraba, Kaimosi and Kamoiwa.
- Modifications to pipelines and cattle troughs at Chemase.
- Insertion of furrow and sluice gate for Sarora dam.
- Extension of Kaptumo, Kabanta, Kilibwoni and KabLamur schemes.
- Installation of one windmill, digging of 15 wells and construction of 255-capped springs and 47 cattle troughs constructed.

At the beginning of 1960, the African District Council was mandated to make a financial reappraisal and reorganize its water supply department. It was decided that it would not seek further loans from ALDEV and would augment with payments for water supply effectively⁷⁷⁹.

Application for water: The president of the Swynnerton plan/the DC, made an application for a community project on water rights within the jurisdiction of Nandi African District Council. The projects were all concerned with the approved expenditure under Swynnerton plan for the Nandi district. Large dams were the responsibility of soil conservation service and small dams were made through communal labour under the control of the agricultural development⁷⁸⁰.

778 Annual Report-Nandi District, (1957 to 1962) Kenya National Archives, DC/KPT/2/1/1. 1962.

779 Annual Report-Nandi District, (1957 to 1962) Kenya National Archives, DC/KPT/2/1/1. 1962.

780 Brown P.H (1956). Nandi District-Swynnerton Plan-Water Application. Kenya National Archives, DC/KAPT/2/1/33, Ref: AGR.11/5/3. 7th February 1956.

The requirements involved 300 small dams, each covering approximately one acre or each have an off take of approximate 1,500 gallons per day for reticulation of over 150 acres. None of the dams was expected to exceed 14 feet 6 inches. There were supposed to be twenty large dams with a total capacity of approximately three million gallons.

The offtake for reticulation was planned for 45.5 m³ per day to cover domestic and stock requirement over 1000 acres in each case. None of these dams was planned to exceed 365 centimetres by 15 centimetres.

At KabLamur River, water rights were applied for to withdraw an approximately 68m³ per day for human and stock consumption by reticulated piped supply from a weir. An off take of 118 m³ at Yala River at Kaimosi by ram and piped supply was applied for. It was meant for human and stock consumption in Kaimosi settlement and institute⁷⁸¹.

Kajiado Town: the main option – other than Nol Turesh Pipeline- was development of Isinya aquifer. Several attempts were made to calculate the water demand in the project area and existing and projected demand estimates were available for various years for certain towns and locations. However, the literature survey carried out in 1988 indicated that there were some areas were not covered and most of the earlier studies were unsystematic.

Geography, topography of the area: The project area was geographically disadvantaged due to paucity of water ad rugged topography in arid and semi-arid environments. The entire project area was underlain by rocks and the soil cover was varied and intricate, reflecting variations in geology and land reform. The entire project area was drained by tributaries of Athi River Basin, although five catchments could be distinguished. Most rivers were seasonal due to high precipitation and water shortage was a major constraint on the development of the rural and urban areas. The perennial Nol Turesh springs at the foot of Mt. Kilimanjaro were fed from precipitation outside the area⁷⁸².

The population forecast for the project area (Table 3.40) covering period 1988-2012 estimates that the percentage of urban residents would increase by over 60 percent. The population of Machakos sector were expected to migrate to urban areas, encouraged by further development of Machakos municipality and new Athi Rive Townships as economic growth poles.

781 Brown P.H (1956). Nandi District-Swynnerton Plan-Water Application. Kenya National Archives, DC/KAPT/2/1/33, Ref: AGR.11/5/3. 7th February 1956.

782 Ministry of Water Development (1988) Nol Turesh Water Project: Quarterly Progress Report-September 1988.

Table 3.40: Population projections for Machakos and Kajiado by 1988

Section	1988	1992	2002	2012
Kajiado	51,986	60,522	86,778	124,934
Machakos	246,568	290,583	423,402	605,795
Total	298,554	351,105	510,180	730,729

The Nol Turesh project was expected to be successful if vital role played by the surface water resources for the supply of schemes such as Tana River Transfer, the Munyu Dam and dams on the Athi South of Nairobi and on tributaries of Thwake in the hills of Machakos district was utilized. There was a good groundwater potential both in basement system and volcanic aquifers and ground water development on a local basis was regarded as a key to future development of rangeland, rural areas and small settlement in the southern arid horizons. Water quality was variable but sensible borehole siting techniques was expected to reduce the risk of salinity. The supply was expected to be enough to supply all the small towns to meet the existing demand⁷⁸³.

Muhoya Self-Help Water Supply: The Muhoya Water Supply project was funded by the European Economic Community (EEC) and the beneficiaries. Commissioning was expected to take place in April/May 1995. The Ministry of Land reclamation and Regional water development (MOLRRWD) undertook the design and supervision, whilst construction was being carried out by the local community. The intake was located at Zaina River within Nyeri municipality. In the early 1980s the area was being served by a 50mm dia pipe from Tetu-Thegenge water supply to a 90 m³ masonry tank near Kihuyo market but the supply was insufficient⁷⁸⁴.

In 1993, construction work commenced to augment the supply. A raw water main of 225 mm diameter, uPVC was laid and a 225 m³ masonry reservoir constructed which would feed the existing reticulation. It was intended to serve approximately 250 plots in Kihuyo and Nyarugumu areas within Kihuyo sub-location. It was intended to provide a flow of 4.25l/s for strictly domestic usage. No treatment was intended and supply was by gravity. The beneficiaries were responsible for operation and maintenance of the system, through a committee formed⁷⁸⁵.

783 Ministry of Water Development (1988). Nol Turesh Water Project: Quarterly Progress Report-September 1988.

784 Water Development Department (1965). Rural Water Policy: Memorandum by Director, Water Development Department. June 1965.

785 Water Development Department (1965). Rural Water Policy: Memorandum by Director, Water Development Department. June 1965.

Aguthi Rural Water Supply: Aguthi Water Supply Project was funded by the Danish Government and was undertaken in two phases. Phase I was completed in 1983 at a cost of approximately KES 29 million and phase II in 1989 at a cost of approximately KES 24 million. The project area was approximately 103 km². By 1997, the project was operated by the National Water Conservation and Pipeline Corporation and served approximately 7000 consumers of whom 90% are metered. Of these five hundred were within Nyeri municipality and were all metered. The intake was located near Gura River in the Aberdare's forest. Average abstraction was 5,300 m³/day. Raw water was conveyed by a 10.6km long, 300mm diameter pipe to Mathakwa-ini, where full treatment was undertaken. Raw water was used for backwashing and there was no provision for clear water usage within the treatment works. From the two storage tanks, supply was by gravity to the consumers. The supply was adequate in most parts of the supply area, except those that were on the outskirts of the distribution system such as those bordering the Municipal council system and was used for domestic purposes and livestock demand.

Kabuku Water Project: Kabuku water supply was developed between 1969 and through community initiatives supported by the government, with the main objective of providing members with good quality drinking water. This rural scheme operated up to 1989 when it collapsed due to a combination of poor design and construction, lack of financial management systems, accountability and transparency.

The scheme was rehabilitated between 1991-1992 in a partnership with the Swedish International Development Authority (SIDA) and a local consultancy firm. Building on the lessons of the earlier failure, the rehabilitation program included rebuilding of some physical facilities. More importantly, it included specialized support in the development and installation of systems and guidelines for:

- Operating and maintaining the infrastructure;
- Setting up and running the community organisation; and
- Transparency and accountability in the management of funds.

The rehabilitated scheme was commissioned in 1992 and was since been successfully managed by the community with no external financial support.

The bulk of the water produced was used for income generation activities like watering livestock and poultry, kitchen gardening and other forms of agricultural production by about 60% of the households. Most of the households owned and worked on small pieces of land measuring 450 square metres. A metre-based rising block tariff covering operation and maintenance and replacement costs regulates consumption.

The project supported its operations and system expansion entirely from the revenue collected. Revenue collection was rigorously enforced resulting in 95% collection efficiency within 14 days of billing. Kabuku water Project had one of the best financial performance among rural schemes in the country. The key lessons learned included:

- Group focus aimed at satisfying user demand.
- Enhancement of members' economic activities.
- Adoption of a business approach to service provision and placing the responsibility for continuous service provision on payment by users.
- Community ownership and control through legal establishment of the community organisation and enforcement of by-laws.
- Clearly defined roles and responsibilities that separate ownership, governance and operations.
- Well-established management systems that members have confidence in and that ensure transparency and accountability.
- Broad customer based achievement through friendly financing policies (e.g. access to credit to finance installation of connection).
- Private sector support and access to technical assistance.

Kabuku's experience demonstrated that a combination of demand responsive strategies, consistent capacity building, innovative financing and transparent financial management can stimulate economic activities and lead to sustainable services.

A study of Kabuku water supply that was owned and managed by the community as a cooperative society showed that the society was successful in overcoming most of the difficulties normally experienced by many water supplies (i.e. both public and community based) by instituting measures that favour good water management practices. The checks and balances put in place through good record keeping and use ensure that the society manager performs within the set out targets that are based on water accountability at various levels of the system. The society decisions were based on the analysis of data, information available and the by-laws.

Even though the Society Manager ran the project independently, was answerable to the management committee that was elected in accordance to the by-laws. The management committee was in turn answerable to the members through annual general meetings. In this respect, the Society Manager and the Management Committee considered the water users as customers whose interests related to water services were concerned were taken into account promptly. The society accounts were privately audited annually and the audited report read to the annual general

meeting. The society members were closely involved in the matters of the water system during the annual general meetings where decisions were made, electing the officials and reporting of any vandalism, pipe leakage, etc.

Kibichori Water Supply: The construction of Kibichori water supply started in 1962 and was completed in 1964 at a cost of 52,000 pounds. The water supply was to cover an area of approximately 7,700 acres and originally served 1,062 individual farms, 6 schools and two centres. All farms had individual connections, providing 455 litres per day. From the start there was a political friction within the Council of which advantage was taken by the farmers to refuse payment. Out of potential revenue of 7,000 pounds per annum, the best that was ever collected was around 200 pounds. In spite of the framed rules for operation and revenue collection on the scheme this were never enforced. This led to revenue failure and the Council was inevitably faced with a large financial debt. The water Undertakers rules had inherent inadequacies regarding water charging for consumers not on metered lines. The rules as Gazetted at the time prevented the imposition of a sanction for non-collection of the rates and indiscriminate shut off. The water undertakers' rules related only to metered supplies and not to unmetered supplies such as Kibichori⁷⁸⁶.

The proposal that government should take over the running of the scheme was first made in 1967, but financial constraints and legal as well as transfer procedures prevented this from happening. The Water Development Department (WDD) took over the management of Kibichori water supply on 1st January 1973. The scheme was still technically operative but the department faced problems in establishing ownership of the farms, many of which had changed hands in the intervening years. Identification of individual consumers as well as opposition to the implementation of government water charging rules formed the other major problems⁷⁸⁷.

Turkana Water Supply: Turkana District is situated in the western part of the Northern Eastern province. It was approximately 12949 km² and had a population of 75,000 by 1943. Turkana was an arid plain with a number of mountain ranges. The rainfall ranged from 15 inches per annum in the most favourable parts such as Mogilla to nothing. Turkana had no permanent river and no part was arable⁷⁸⁸.

786 Colony and Protectorate of Kenya, (1954 – 1965). Mbale Market Water Supply. Kenya National Archives, Ref. No. DC/KMG/2/26/35, Nairobi Kenya.

787 Colony and Protectorate of Kenya, (1960 – 1968). Kibichori Water Supply Scheme. Kenya National Archives, Ref. No. Wat/West/1/1, Nairobi Kenya.

788 Turnbull R.G (1943). Water Requirement in Turkana, DC/15/3/4/43, Ref: PW.8/5/ Vol.1, 28th December 1943.

The Turkana were pastoral people and the major problems were pastoral. All events, whether administrative, medical or educational, depended on the availability of water and grass for cattle, goats, sheep and camel. The Turkana depended for food on the milk, blood and flesh obtained from their stock and few berries. People and animals suffered considerable hardships and fighting arose over the allocation of the limited water available⁷⁸⁹.

River Suam, also known as River Turkwel after crossing the West Suk district border was the main water supply for West Suk, southern Turkana District and for a large part of northern Turkana district⁷⁹⁰. The riverbed dried for a greater part of the year when it entered Turkana district. After that water was only obtained from digging certain favoured places. Lodwar obtained water from holes in the riverbed of River Turkwel. Any diversion of water from River Suam diminished the water holes supply in River Turkwel therefore such diversion would adversely affect the African Population and the stock. The chief native commissioner and the senior commissioner were over concerned about this⁷⁹¹.

Only small revenue could be collected from water charges if boreholes were made in Turkana province. The Provincial Commissioner attributed this to the high poverty level among the Africans⁷⁹². Only annual revenue of 250pounds from West Suk district was available for the province. Both Northern Turkana and Southern Turkana lacked both administrative capacity from local native council and revenue. Therefore, in order to undertake water-boring works, money and machinery were needed first.

In March 1930, a sub-committee of provincial commissioners made the following recommendations:

- The government to institute a water boring section and provide funds for five machines for African reserves.
- The government to undertake installation and maintenance of pumping plant.
- Local native councils to guarantee interest and sinking fund on cost of operations and erection of machinery and cost met by annual payments.
- Local native council to decide if they should levy water rates.
- The boreholes in native reserves should be sunk at a greater depth than 61 metres.

789 Turnbull R.G (1943). Water Requirement in Turkana, Kenya National Archives, DC/15/3/4/43, Ref: PW.8/5/ Vol.1, 28th December 1943.

790 Chief Native Commissioner (1929). Proposed Diversion of Suam River, Kenya National Archives, DC/LDW/2/24/3, Ref: NPW. 4/3/1/1/8, 23rd July 1929.

791 Acting Senior Commissioner (1929). Proposed Diversion of Suam River, Kenya National Archives, DC/LDW.2/24/3, Ref: PW/3/1/1, 26th July 1929.

792 Provincial Commissioner, Turkana (1930). Water Boring, Kenya National Archives, DC/LDW.2/24/3, Ref: PW.3/1, 31st October 1930.

The chief native commissioner confirmed the availability of machinery for use in the native reserves but after satisfactory arrangements in payment of cost. The average cost of sinking a borehole (including the cost of transport, fuel and installation of plant) was about 600 pounds.

To pay for the bores, the chief native commissioner made two suggestions: a payment of 10% per annum to cover both the capital charges and maintenance and employing a native clerk to sit at each borehole and charge for everyone who fetched water. The latter system had been successfully established in Sudan and Mombasa⁷⁹³.

In the African reserves, the Turkwel gorge had a definite engineering value. The executive engineer observed that during floods there was a significant depth of water, which ran off rapidly and disappeared. He proposed major development of the gorge but anticipated objections from the Africans on any attempt to impound water in the gorge.

The scheme to impound excess water was proposed with the reservoir collecting water during floods to protect the lower riparian rights. This according to Campbell was the best way of conferring benefits to the district under the native betterment fund. The dam was expected to serve as a roadway, thereby obviating the necessity for bridging the Turkwel River at some point. Power could also be generated under the scheme⁷⁹⁴.

Installation of any means of conserving and procuring water for the Africans was of utmost importance and was a big boon according to the district commissioner, Turkana. Shallow wells and boreholes were the most appropriate for Turkana. Water was required for, cattle sheep, goats, and camels. The District Commissioner was concerned that Turkana was the worst hit district and yet had received least assistance⁷⁹⁵.

In 1939 the District Commissioner prepared a report on existing water sources in Turkana District as illustrated in Table 3.41⁷⁹⁶.

793 Chief Native Commissioner (1931). Water Boring, Kenya National Archives, DC/LDW.2/24/3, Ref: NPW.4/8, 25th April 1931.

794 Campbell H.A (1933). Water Control-Native Reserves-West Suk, Turkana Gorge, Kenya National Archives, DC/LDW.2/24/3, Ref: 433/7/1/1/4, 15th March 1933

795 District Commissioner, Turkana (1935). Water Supplies in Native Reserves, Kenya National Archives, DC/LDW.2/24/3, 10th August 1935.

796 District Commissioner, Lodwar (1939). Water Supplies in Native Reserves, Kenya National Archives, DC/LDW.2/24/3, Ref: 119/10, 17th February 1939.

Table 3.41: Water retention period for the existing water sources in Turkana District

River	Water Retention Period
Nafaas	All year round
Oripoi [Kalopeto]	Most of the year
Loya	4 months after the rains
Kekarikirion	2 months after the rains
Tia	2 months after the rains
Lokwamur	2 months after the rains
Lotharjait	2 months after the rains
Lopirpira	2 months after the rains
Gatome	After few months
Newanyamoi	Dried immediately after the rains.

In 1943, Dixey in company with the District Commissioner R.G Turnbull toured Gapuss, NatiraPass, Kakuma, Napas, Anaam, and Lokichoggio and made a report on Central, Western, and North Western Turkana. They observed that the existing dry season water supplies consisted of water holes a few metres deep in the numerous sandy riverbeds, the springs that were more or less saline and the rainy season supplies. These were sufficient for all of the plains. People generally suffered great hardship. The government by the year 1943 had not undertaken any kind of water supply measure⁷⁹⁷.

The district commissioner recommended provision of improved water supplies at nine localities. All these were obtainable in adequate amounts only by drilling and the geological and the topographical conditions were favourable⁷⁹⁸.

In the same year (1943), Dr. Dixey in company of the district commissioner R.G Turnbull toured southern Turkana which consisted of the following centres among others: Loki char, Kaputir, Lobongito, Kachoding, Kangetet, and Loperot.

Compared to other parts of the northern frontier district, south Turkana was well supplied with water in the form of water holes, springs, and at least one running stream. After the rains, there were numerous temporary water supplies in form of pools and water holes. Many of the permanent supplies were however inadequate because of the heavy demand and urgent requests for new supplies were put forward by the officers in charge of the district.

797 Dixey F (1943). Central Western, and North Western Turkana, Kenya National Archives, DC/15/3/4/43, Ref: PW.8/5/ Vol.1, 28th December 1943.

798 Dixey F (1943). Central Western, and North Western Turkana, Kenya National Archives, DC/15/3/4/43, Ref: PW.8/5/ Vol.1, 28th December 1943.

Most of the localities in the south Turkana offered satisfactory prospects of success since they were on temporarily dry stream courses underlain by basement complex rocks. Those conditions normally resulted in moderate yields. Dixey recommended provision for an average of two boreholes each equipped with hand pump and concrete troughs at each locality⁷⁹⁹.

The need for new or improved water supplies was felt in different localities within the whole Turkana district for the following reasons⁸⁰⁰:

- To serve the police post for security reasons.
- For locust control operations.
- Facilitate and access the grazing of certain hill areas.
- Generally to relieve the hard lot of many Turkana people and improve their life.
- For administrative purposes.
- Minimizing the risks of clashes between the Turkana and the local Uganda tribesmen.

Dixey estimated the cost of augmenting water supplies in isolated parts of northern frontier and over a period of six years. He recommended that the operations in the three areas be carried out as parts of one scheme for most economical application of staff. He estimated a total of 75,360 pounds for plants, buildings and equipment and 364,068 pounds for works and supervision⁸⁰¹.

In May 1951, work was started on the northern Turkana water development scheme, based on Mr. Classen's proposals. Under the supervision of Mr. Black the following works were done.

1. Kawalathe well was cleared and enclosed in a well ring.
2. Three wells were sunk at Kakalai and waterholes cleared out.
3. Attempts to sink wells at Gaikwar failed as no water was struck.
4. The two Samburu wells at Karibur were cleaned and their sides raised to prevent silting up that occurred when the river flooded. A third well was sunk by cutting through the rock.
5. A dam was built across the Lokitaung River near the wells with the main objective of thus recharging the wells more effectively.

799 Dixey F (1943). Central Western, and North Western Turkana, Kenya National Archives, DC/15/3/4/43, Ref: PW.8/5/ Vol.1, 28th December 1943.

800 Turnbull R.G (1943). Water Requirement in Turkana, Kenya National Archives, DC/15/3/4/43, Ref: PW.8/5/ Vol.1, 28th December 1943.

801 Dixey F (1944), Director of Water Development in Northern Rhodesia. Kenya National Archives, DC/LWD/2/24/10, 14th January 1944.

Unfortunately, the work done so far did not increase the quantities of water actually available- except in Lokitaung. The Turkana were too conservative to use the wells since it was quicker and easier to water the stock by digging holes in the riverbeds than using wells. Alternative plans were formulated to make future works done more directly useful⁸⁰².

Nandi Water Supply: Nandi water supply development was predominantly the Swynnerton plan. Although dams were essential in raising the water table, much of Nandi was suitable for the wells. Wells were the best form of water supply for smallholdings and were essential for proper management. The ALDEV board agreed that wells were vital to the development of the district. However, the greater need for them outdid the available supervision and organisation. At the meeting of ALDEV board held at Nakuru, the board passed that a works organisation be set up to organize individual water supplies⁸⁰³.

All the projects were for the benefit of a community and not for any specific individual, while the purpose of the supplies are for domestic and irrigation reasons. The total quantity to be taken out of the rivers in the district was not supposed to exceed 3141 m³ per day. This total was expected to be built up over the years. The rivers concerned were the Yala, Kipkarem, Kundos, Kibos and Orobo and their tributaries⁸⁰⁴.

Kacheliba Water Supply: By 1983 Kacheliba was the divisional headquarters in Karapokot Division of Rift Valley Province. It was situated 450km northwest of Nairobi and close Kenya and Uganda border. The Kacheliba water supply was designed by Nor Consult and constructed by direct labour section. The scheme was commissioned in September 1982 and the total cost of construction was approximately KES 5.6million. A storage water tank for Kacheliba water supply is illustrated in figure 3.49.

802 District Officer (1951-1955). Lokitaung Sub District Annul Report, Kenya National Archives, LOK/9, Ref: DC/LOK/1/3, 1955.

803 ALDEV Board meeting held on 12th and 13th July 1954, minutes 60. Kenya National Archives, DC/KAPT/2/1/33, Ref: AGR.11/5/3/23. 13th August 1954.

804 Brown P.H (1956). Nandi District-Swynnerton Plan-Water Application. Kenya National Archives, DC/KAPT/2/1/33, Ref: AGR.11/5/3. 7th February 1956.

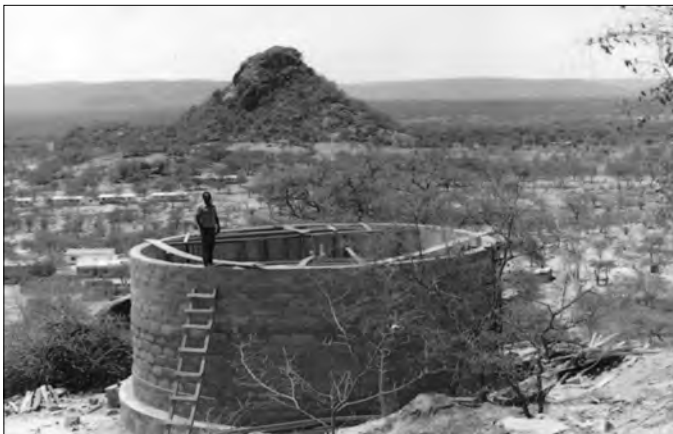

Figure 3.49: 150 m³ storage tank under construction⁸⁰⁵.

The water demand was expected at 465 m³ per day and 671 m³ per day in 1985 and 1995 respectively against 3695 and 4655 people in 1985 and 1995 respectively. The only

existing water supply was operated by the catholic Mission. Water was abstracted from Suam River and pumped to a small area of the township and to the mission⁸⁰⁶.

The new scheme was constructed 100m upstream of the existing scheme, infiltration well, pump house, two turbines, chlorination house, rising man and distribution lines were put in place. The scheme was not visited half a year after commissioning, but it was reported that the supply was satisfactory. The project was not operational and very little information about it was available by 1989. A sink well (figure 3.50) had been constructed and the excavation was ongoing for the pump house 60 metres from the sink well.



The temporary diesel electric submersible pumping set could be seen in the back⁸⁰⁷

Figure 3.50: A sink well under construction⁸⁰⁸.

805 Hunn G (1983). Progress Report about Water Projects Included in the Minor Urban Water Supply Programme. NORAD, Nairobi.

806 Hunn G (1983). Progress Report about Water Projects Included in the Minor Urban Water Supply Programme. NORAD, Nairobi.

807 Nor Consult A.S (1988). Development of an Integrated Physical/Financial/Socio-Economic Monitoring and Evaluation Programme for Water Supply Schemes, Draft Final Report, Report No. 9. Ministry of Water Development, Republic of Kenya.

808 Hunn G (1983). Progress Report about Water Projects Included in the Minor Urban Water Supply Programme. NORAD, Nairobi.

Kalokol Water Supply: Kalokol was rural centre in Turkana District, Rift Valley province. It was located at the Ferguson's Gulf on the southern bank of Kalokol River. The river was mainly dry for 364 days a year but had a reasonable subsurface flow. The altitude was 400 metres above the sea level. The climate of the region was hot and dry with an average annual rainfall of less than 250mm.

Nol Consult completed the first government operated water supply in 1972. The intake was situated at the opposite side of the Kalokol Laga, and consisted of a shallow well and shallow infiltration lines. The well and infiltration lines could not supply sufficient water to Kalokol, and dried up completely during dry periods. An augmentation to the scheme was therefore required and this was carried out by direct labour section in the period 1979 to 1982⁸⁰⁹.

The scheme was handed over to O and M in June 1982, but some items were not completed. The elevated steel tank, which was erected by a sub-contractor, was faulty by 1983. There was a need to replace the 80 m³ tank with a 200 m³. The total cost of outstanding work, including a new 200 m³ tank, tools and laboratory equipment, as well as completing a standby scheme with three well points was estimated at one million shillings.

Ortum Water Supply in West Pokot District: This water supply was completed in November 1965 and was in operation. Extension of the supply from the mission to the trading centre was being carried out; Wamba Water Scheme extension in Samburu District was serving a school, health centre, slaughterhouse and public water point. The extension refers to a pipeline service from the water point to the duka area and every material required for the extension had been supplied to the local county council also there was Maralal Piped Supply which was also providing piped services to the new slaughterhouse⁸¹⁰.

Kisoko Water Scheme in South Baringo: The supply was in operation for approximately six months. It was serving more than 100 farmers and providing 20 water connections at Magoto Township. In Narok District in Olulunga Health Centre there was wind mill pump raising water from the river to a storage tank at the health centre. At the same time there was a need for piped water supply to serve the Health Centre at Norosura and this entailed pumping and piping equipment from a river source at the vicinity. In addition the piped water supply to Ngare Health centre from Nairangie stream was unsatisfactory because the flow apparently ceased at

809 Hunn G (1983). Progress Report about Water Projects Included in the Minor Urban Water Supply Programme. NORAD, Nairobi.

810 WHO Project Kenya/2. (1966) Visit to Provincial Medical Headquarters-Rift Valley Province. Kenya National Archives BY/29/11 18th March, 1966.

certain times. This condition was aggravated by defective polythene piping which needed to be replaced with galvanised piping⁸¹¹.

Baringo District Water Supplies: Baringo District was in the then Rift Valley Province with arid and semi-arid climatic conditions. In October 1969, the clerk of the council made an application to the minister of agriculture for appointment of water undertakers. There were about eighteen centres intended for supply in south Baringo area and about thirteen centres in north Baringo area intended for supply (figure 3.51). Upon appointment, the undertakers were to start working immediately⁸¹².

In Pokot, Tangulbei, Nyau-Nyau, Losikiriamoi and Chemalingot boreholes were dug and completed in 1967 but started operation in 1975. The delay was caused by lack of running and maintenance funds from both central and local authority. The local people contributed some money bringing them back to operation. The government wanted to take over the boreholes for better maintenance, an issue which the district commissioner and the Marigat district officer discussed. The area around these boreholes was terribly hit by drought in March 1975 forcing the government to look into all possibilities of taking over all the county council boreholes⁸¹³.

The government of Denmark through DANIDA supported a rehabilitation Programme in Rift Valley province. The Programme was meant to improve, Mogotio, Kabartonjo, Tangulbei, Nginyang and Chemolingot projects in Baringo district. A consultant Carl Bro (Kenya) Ltd undertook surveys to determine the extent of rehabilitation work needed on the water supplies. Three expatriate technicians and ministry of water development staff in Rift Valley province were expected to use the findings of the consultant and rehabilitate the projects.

Kabartonjo water supply extensions were included in the rural water supply (RWS) 1 and were completed in 1971 to serve 2600 people. Torongo and Nginyang water projects were completed between the commencement of Rural Water Supply and Minor Urban District Water Supply Programmes in early 1970s and 1980s. The three projects cost 2,180,000 shillings.

Projects: The local people started the Nyalilkirug water project in 1970. The objective to provide water to over 5000 families and their animals estimated at 15,000 heads of cattle and 6000 goats and sheep. They also intended to provide water for schools, trading markets and cattle dips. By 1977, they had raised over 100,000

811 WHO Project Kenya/2. (1966) Visit to Provincial Medical Headquarters-Rift Valley Province. Kenya National Archives BY/29/11 18th March, 1966.

812 Daily Nation (1969). North and South Baringo Area Councils, (Water Act Cap 372, Appointment of Water Undertakers. Kenya National Archives, RP/21/23, 27th October 1969.

813 Nasieku D.K (1975) Official Visit of the Minister for Water Development Hon. E. Mwamunga to Baringo District on 8th and 9th March 1975. Kenya National Archives, RP/21/23, Ref: MOW/8/3/VIII/156. 21st March 1975.

shillings, which was used to install water pump engine and two storage tanks. The CARE Kenya aided the project through provision of pipes worth 138,000 shillings, which were laid from the rising main to the tank. The Baringo district development committee (DDC) granted 100,000 shillings, which was used for purchase of plastic pipes and employing contractors and transportation.

Through the chairman, the project administration pleaded for government assistance to complete the project. They asked for financial assistance and surveyors to design all the pipelines for proper estimates and actual costing of the whole project. They also requested the minister for water development Dr. J.G Kiano to tour the district.

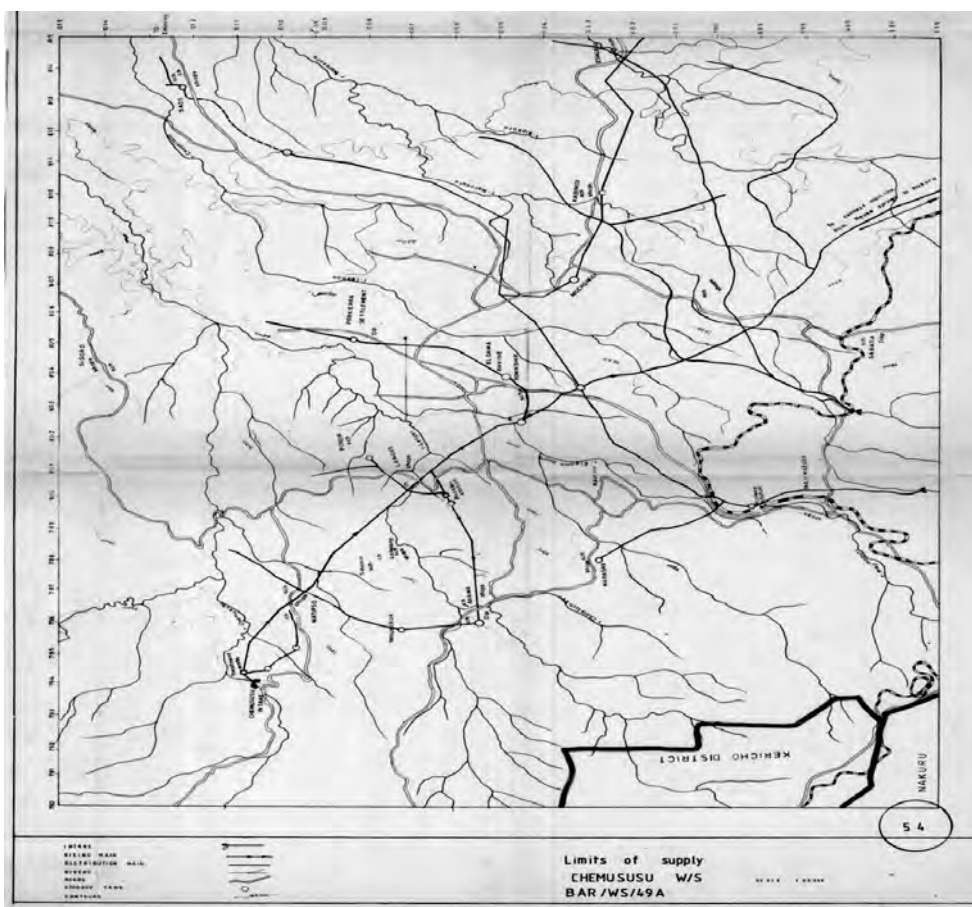

Figure 3.51: Baringo District showing location of water supplies⁸¹⁴

⁸¹⁴ Ministry of Water Development, Kenya and Ministry of Foreign Affairs, Finland (1992). Kenya Finland Western Water Supply Programme: Operation and Maintenance manual-Kaimosi Water Supply. 1992.

In early 1978, the government was focused on increasing the attention on development of arid and semi-arid areas and requested World Bank assistance for a project to develop the drier parts of Baringo district. The bank decided that the project would be a pilot effort. Its objective was to prepare a long-term investment program for the Baringo semi-arid areas. Further, the project would test techniques and agricultural packages, which would be replicable in arid semi-arid areas in Kenya. At the same time, a number of multilateral and bilateral agencies were assisting with projects in these areas.

The government defined nine separate arid and semi-arid areas where some development activities were planned. The activities were aimed at developing techniques and policies to reverse the existing water supply decline and improve incomes of the local people.

In 1980, the development activities in the water sector in Baringo district involved three major areas. These were water supply projects in rural and urban areas, the sewerage projects and minor irrigation projects. According to the ministry of water development report of January 1980 on water and sewerage projects in Baringo district, there was considerable irrigation potential in the Kerio valley basin. The basin is on the entire western boundary of Baringo district.

The water supply and sewerage development activities in the district were estimated to cost about 67 million shillings. They comprised 48 million shillings for water supply, 18 million shillings for sewerage projects and 1 million for self-help water projects.

Bungoma District Rural Water Supplies: Project was conceptualized in 1975 and was included in Minor Urban Water Supply Programme. In the same year the project was put under design and was planned to start in the 1976/77 financial year. The construction started on time and was completed in 1980. The scheme obtained water from the Kuywa River and a dam on Chwele River. The water was pumped to a storage tank at Makutelo from where it was supplied by gravity to Bungoma Township. The population of the township at the time was 6,000 and was expected to rise to 32,000 by 1995. The rural population along the main from the treatment works was to be served by the pipeline. The total cost of the project was 500,000 pounds⁸¹⁵.

Ndivisi: Makuselwa water project was initiated as part of the Rural Water Supply II projects (RWS II). In the Daily Nation of 27th July 1971 the Republic of Kenya

815 Colony and Protectorate of Kenya (1956). Medical Department, Bungoma Sanitation and Conservancy/ Bungoma Water Supply. Kenya National Archives, Ref. No. BY/29/50, Nairobi, Kenya.

through the Ministry of Agriculture water development division advertised for tenders to construct the Ndivisi Makuselwa water project. The water was drawn from River Kimilili in Mt Elgon constituency to Ndivisi and Makuselwa at Broderick fall (Webuye). The construction of the Ndivisi – Makuselwa water project took place in 1973 and was completed in 1974. Later in 1982 the Ndivisi – Makuselwa water project was through self-help extended to Senjula and Chingila⁸¹⁶.

Lwakhakha Market: As at 1980 the people of Lwakhakha Market were obtaining raw water from River Lwakhakha and this led to a serious outbreak of Cholera. The District public Health office was forced to provide a small water scheme for emergency supply of wholesome water while at the same time the springs of the neighbouring villages were protected as long term effort of alleviating the problem. The immediate solution was to install a small engine to pump clean water to the resident of Lwakhakha market and then later to include a line from Chesakaki water scheme to serve the same area. The extension from Chesakaki to Lwakhakha a distance of 9km away was immediately approved by the district development committee and designs plus cost estimates established. The Chesakaki water scheme was an extension of the Kibichori water scheme which had been started in the early 1960's⁸¹⁷.

Chemoge / Kapsokwony water project: This project was started on a self- Help basis in early 1975. The government offered KES 90,000 for the construction of a pump house, pumping equipment, the rising main and part of the distribution. The construction started but stalled due to lack of commitment on the part of the self-help groups. By 1981 it was still at halt⁸¹⁸.

Kapkatet Dispensary Water Supply: In 1944 the proposed development centre for Kapkatet dispensary was inspected and it was found that it was difficult to obtain adequate water supply in the area. Although the area had heavy rainfall the possibility of droughts up to two months rendered water storage a big problem. There were two permanent and big yielding springs from where water was drawn⁸¹⁹.

The water from Daraja Sita Swamp needed to be pumped to a higher height of about 400 ft. it was clear but there was a likelihood of it being contaminated by

816 Republic of Kenya (1972-1974). Ndivisi – Makuselwa water project. Kenya National Archives, Ref. No. WAT/47/1, Nairobi, Kenya.

817 Republic of Kenya (1980). Water supply – Lwakhakha Market. Kenya National Archives, Ref. No. WAT/47/1, Nairobi, Kenya.

818 Colony and Protectorate of Kenya (1943 - 1962). Butere Water Supply. Kenya National Archives, Ref. No. DC/KMG/2/26/44, Nairobi Kenya.

819 Divisional Engineer (1944) Post war Development. Kenya National Archives. PC/NZA/2/14/53 Ref 1368/13/13/1 10th June, 1944.

rotting vegetables and in that case it would be very difficult to purify⁸²⁰. But the swamp would finally be used for the full scheme. The use of the swamp would be costly both in initial cost and operation and it was proposed that early provision should be made to meet the cost⁸²¹.

The District Commissioner reported that he was unable to sink a well without money presumably from the hospital vote and the P W D could not get money for the hospital till the well was dug. The ideal scheme was to sink a borehole, but as an alternative, money was needed for digging a well. The second alternative was to pump the water from the swamp. In this also money was needed to buy a small engine and piping. This could be acquired locally at a cost of 100 pounds⁸²². Getting funding was a tedious exercise.

The Director of Public Works reported that the type of pump needed for pumping water from the well was different from that required for surface pumping from the swamp. In addition provision of funds could not be recommended for the purchase of the pump, until the well had been sunk, tested and proved. And if sinking of a well was approved it would be necessary to apply for funds as those ones already given, under head 39 P W D water supplies and drainage were exhausted⁸²³.

In 1945, the Hydraulic Engineer stated that it was unwise to proceed with the building of a native hospital at Chepkatet until an assurance was obtained for a water supply. There was no certainty of a water supply and he recommended that the question of water boring should be taken as soon as boring plant was obtained⁸²⁴. However, there was an urgent need to proceed with the work of construction. In 1945, the construction of Medical Buildings at Kapkatet was stopped temporarily pending the decision concerning water supply. It appeared that two alternative sources of water supply were available⁸²⁵. Firstly, water from a well or borehole on which the Engineer Geologist had reported favourably and an experimental well had been dug up to a depth of about 24 metres. Secondly, a pumped supply from the

820 Divisional Engineer (1944). Post war Development. Kenya National Archives. PC/NZA/2/14/53 Ref 1368/13/13/1 10th June, 1944.

821 Divisional Engineer (1944). Post war Development. Kenya National Archives. PC/NZA/2/14/53 Ref 1368/13/13/1 10th June, 1944.

822 District Commissioner, Kericho (1944) Medical Facilities-Kapkatet Centre. Kenya National Archives. PC/NZA/2/14/53 27th July, 1944.

823 Director of Public Works (1944). Medical Facilities Sotik. Kenya National Archives. PC/NZA/2/14/53 Ref. B 2561/3/7/10/16 17th August, 1944.

824 Director of Public Works (1945). Native Hospital Chepkatet. Kenya National Archives. PC/NZA/2/14/53 Ref. B 652/8/6/10/16 9th February, 1945.

825 Divisional Engineer (1945). Public Works Extraordinary 39 D Medical Buildings Item 14- 4260 Pounds Kapkatet. Kenya National Archives. PC/NZA/2/14/53 Ref. 1172/2/10/19/1 28th May, 1945.

Daraja Sita Swamp, which he reported, would be difficult to purify and expensive to pump, but could be adequate⁸²⁶.

In 1945, the subject the Social Centre at Kapkatet was discussed with the Governor, and Chief Native Commissioner. It was reported that the construction of Kapkatet Social Centre was being held up owing to the removal of the Military Boring Plant from the area.

Consequently, it was proposed that swamp water should be used unpurified for all purposes other than domestic drinking. Rainwater tanks could provide drinking water. The Provincial Commissioner supported the proposal, as opposed to waiting for the boring plant which could take time. He said that a pump and piping was all what was needed to have the assured water supply and the objective of the centre was to provide some amenities for the returning soldiers. He then requested for the general approval of the proposed project so that the construction of the hospital could continue⁸²⁷.

Kaimosi Water Supply: Kaimosi water supply was located in Hamisi division of Vihiga district, Western province. The water supply was situated approximately 10 kilometres from Chavakali along the Chavakali-Kapsabet road, 0.75 km south west of the hospital. The water supply was constructed in 1976 to provide portable water to the following institutions: Kaimosi Teachers College, Kaimosi Girls Secondary School, Primary School, Friends College, Friends Bible Institute, Nursery School, Primary School, institutional staff and livestock⁸²⁸.

The treatment works comprised of two independent water treatment processes. The lines were conventional treatment unit and a Struja treatment unit. Both lines offered full water treatment composed of: intake works, mixing chamber, flocculation process, sedimentation process, filtration process and disinfection. The conventional treatment comprised of a flocculation through sinusoidal type of flow, horizontal flow sedimentation tanks and circular rapid sand filters. There was also storage clear water tank, high lift pump house of which pumps were shared with the Struja, the Struja treatment process and an elevated steel wash tank shared with Struja treatment process as illustrated in figure 3.52⁸²⁹.

826 Divisional Engineer (1945). Public Works Extraordinary 39 D Medical Buildings Item 14- 4260 Pounds Kapkatet. Kenya National Archives. PC/NZA/2/14/53 Ref. 1172/2/10/19/1 28th May, 1945.

827 Provincial Commissioner, Nyanza Province (1945). Kapkatet Social Centre. Kenya National Archives. PC/NZA/2/14/53 Ref. PH/2/1/7/120 4th June, 1945.

828 Ministry of water development, Kenya and Ministry of Foreign Affairs, Finland (1992). Kenya Finland Western Water Supply Programme: Operation and Maintenance manual-Kaimosi Water Supply. 1992.

829 Ministry of Water Development, Kenya and Ministry of Foreign Affairs, Finland (1992). Kenya Finland Western Water Supply Programme: Operation and Maintenance Manual-Kaimosi Water Supply. 1992.

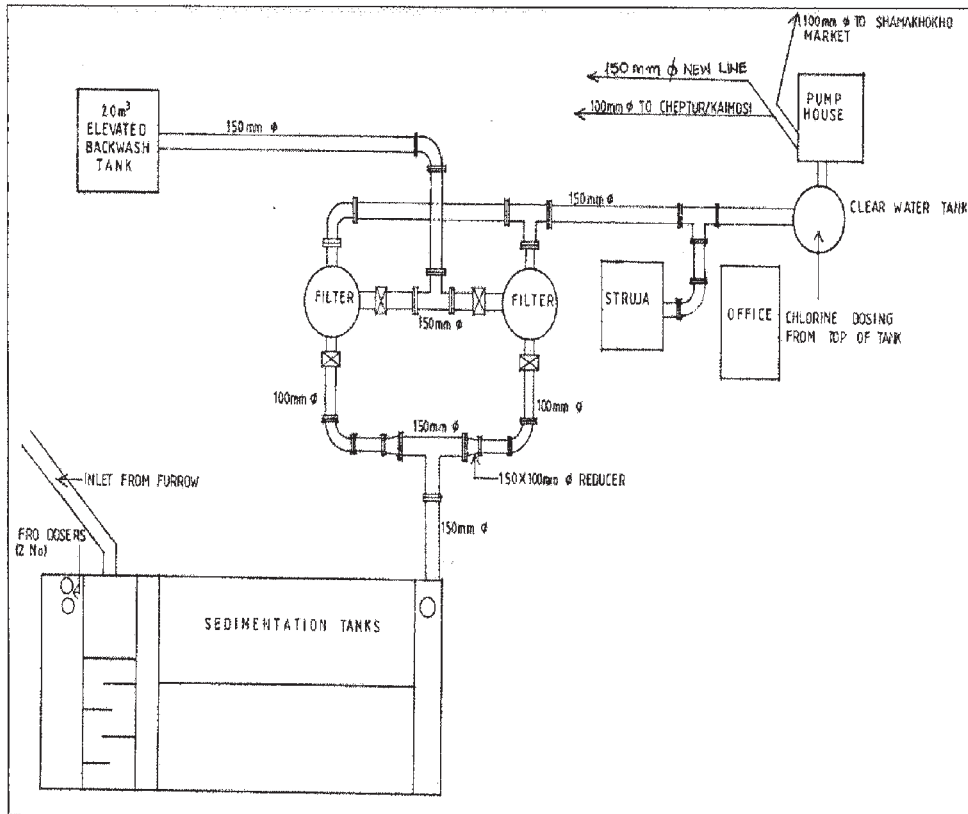

Figure 3.52: Kaimosi treatment works in 1992⁸³⁰.

On the other hand, the Struja process constituted the following process stages: raw water intake pumping, coagulation/flocculation, clarification, filtration, disinfection, and neutralisation. Clear water tank, high lift pumping and wash water tank were shared with the conventional treatment plant (figure 3.53)⁸³¹.

830 Ministry of Water Development, Kenya and Ministry of Foreign Affairs, Finland (1992). Kenya Finland Western Water Supply Programme: Operation and Maintenance Manual-Kaimosi Water Supply. 1992.

831 Ministry of water development, Kenya and Ministry of Foreign Affairs, Finland (1992). Kenya Finland Western Water Supply Programme: Operation and Maintenance manual-Kaimosi Water Supply. 1992.

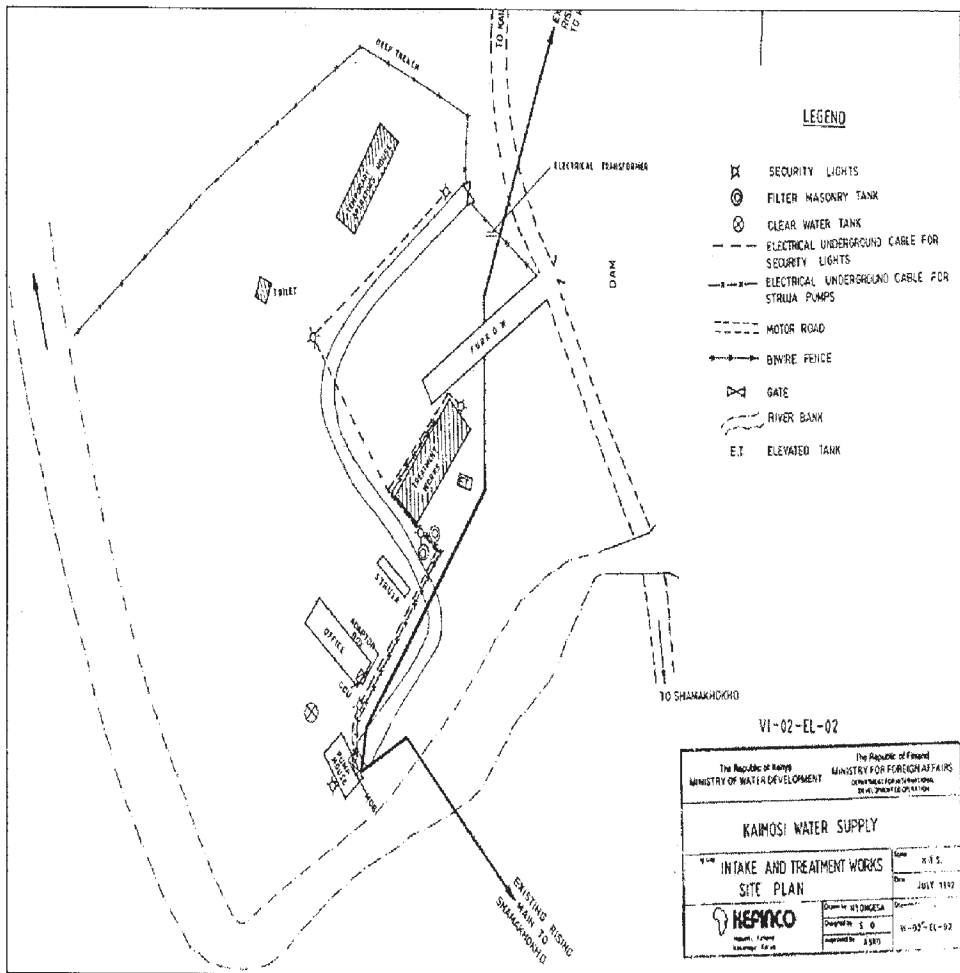

Figure 3.53: Intake and treatment works for Kaimosi water supply in 1992⁸³²

Kiambu District Water Supplies: In early sixties, there was a water master plan for Kiambu District and technical information was made available to Kiambu African District Council. However, for some unknown reasons, it never took place. At that time, Kiambu had a very good financial status, a condition that later prevailed in 1977 due to coffee cess.

Consequently, the idea of reviving the water supply in the entire Kiambu area financed by the council was once again put into consideration. Mr. Kariithi brought about the idea and Mr. Nyachae; the provincial Commissioner Central province

⁸³² Ministry of Water Development, Kenya and Ministry of Foreign Affairs, Finland (1992). Kenya Finland Western Water Supply Programme: Operation and Maintenance manual-Kaimosi Water Supply. 1992.

supported it. The DC, Kiambu, the clerk to the council and the PS for local government investigated into the matter⁸³³.

Gatamaiyo water project: In May 1977, the minister for water development Dr. J.G. Kiano met the central management committee of the Gatamaiyo self-help water project. He gave them a cheque worth KES 15,000, a token contribution by the ministry towards the project. The minister then directed the water department to design the project immediately⁸³⁴.

Kabuku self-help water project: The project was in Limuru division, Kabuku sub location. Its aim was to extract water from Karura River and supply the whole sub location, about 1154 people, with water. The project, through Mrs. Beatrice Babu of Nairobi Hospital, requested for the first technical assistance from the water department in 1971. A hydrological survey confirmed availability of 227 m³ of water per day for domestic use from Karura River. This prompted immediate dispatch of a technical officer to carry out the necessary survey. By Mid-April 1972, the design report was ready. This was soon dispatched to the organizing committee through Mrs. Babu. The cost of implementing the whole project was estimated at 100,000 shillings⁸³⁵.

However, the project did not take place. Efforts to revive it started in 1977. The number dependent upon it had risen to 1832; this in combination with other factors increased the cost to at least 200,000 shillings. The self-help scheme coordinator, Githendu felt that the scheme needed some external support⁸³⁶.

Thiririka/Ndarugu/Karimenu Water Scheme: According to the ministerial brief, the preliminary design for this three-part major water supply scheme was completed in March 1973. It was estimated to cost 812,000 Kenya pounds (an equivalent of KES 16.24 million). The work was carried out in phases, in general accord with the consultants' recommendations and according to the Rural Water Supply Programmes⁸³⁷.

833 Kungu N.S (1977). Kiambu Water Supply. Kenya National Archives, RP/21/24, Ref: WAT/49/3. 3rd May 1977.

834 Muigai N (1978). Self-Help Water Projects in Gatundu. Kenya National Archives, RP/21/24, Ref: WAT/49/3. 21st December 1978.

835 Githendu G.G (1977). Kabuku Self Help Water Project. Kenya National Archives, RP/21/24, Ref: WAT/49/3. 12th may 1977.

836 Githendu G.G (1977). Kabuku Self Help Water Project. Kenya National Archives, RP/21/24, Ref: WAT/49/3. 12th may 1977.

837 Munoru P.G (1979). Self-Help Water Project Kenya National Archives, RP/21/24, Ref: WD/2/7/150/14D. 24th April 1979.

Ndarugu water project: Ndarugu phase II had a bulk pipeline running through the scheme. A contractor did major portion of the work. It was completed in 1974/75 at a cost of 186,000 Kenya pounds. The Ndarugu phase I first stage treatment works was done by a contractor. It was scheduled for completion in September 1976 at a cost of 60,000 Kenya pounds. Some of the self-help projects were covered in this project.

Handege-Githunguri self-help water project was constructed at an estimated cost of 890,000 shillings. The Ministry of Water Development was not involved in any design of the project. The Ndege/Githugucu project was in Ndarugu/ Ngenda location and residents were digging trenches by 1978. Wamwangi/Gathaite/Nyaman-gara Projects in the same location were very similar and covered three adjacent ridges. The community around built tanks and contributed some money with an idea to get water from the main Ndarugu scheme. The ministry agreed to send an engineer to design the trenches and provide necessary pipes⁸³⁸.

Karimenu water project: The Ministry of Water Development Labour section undertook the first phase of Karimenu water supply. The works consisted of; construction of the river intake weir, a main 100cubic metre storage tank, four break pressure tanks and 20-kilometre trunk main of diameter varying from 10 inches to 2 inches. By 1977 majority of the pipelining had been completed. However due to persistent delays in delivery of materials and frequent breakdowns of transport and mechanical plant, the work was very slow. It was estimated that the first phase would be finished by June 1978 if further delays were avoided at an estimated cost of 903,000 shillings. Any delay was estimated to increase the cost by 30,000 shillings per month. Macaw self-help Water Project had enough pipes from the raising main and a pump and only 429,000 shillings were required for completion of the project. The community under Macaw project had contributed some funds and built some a large which they intended to extract water from Chania River. In assistance, the ministry agreed to provide an engineer and pipes⁸³⁹.

Thiririka water project: The phase I of Thiririka project was included in the Self-Help Commodity Aid tender from the Netherlands. The total project cost was estimate at 12million shillings. Pipes and fittings cost 4.5 million shillings. According to the Aid agreement, the people within the supply area were supposed to contribute cash to a value of 5% project cost i.e. 600,000 shillings and provide labour for trench

838 Munoru P.G (1979). Self-Help Water Project Kenya National Archives, RP/21/24, Ref: WD/2/7/150/14D. 24th April 1979.

839 Munoru P.G (1979). Self-Help Water Project Kenya National Archives, RP/21/24, Ref: WD/2/7/150/14D. 24th April 1979.

excavation and backfilling valued at 900,000 shillings. The government on the other hand planned to contribute materials and supervision valued at 6 million shillings under Rural Water Supply IV Programme. The rest of the phases were scheduled for 1982/83 works⁸⁴⁰.

After a fundraising event conducted by her Excellency, Mama Ngina Kenyatta, the government, through the district officer remitted 480,000 shillings to the Thiririka water project. It was deposited to a deposit account with the Ministry of Water Development. Thiririka water project supported several self-help projects⁸⁴¹.

Kihara water project: This was in Kiganjo location; its intake works, rising main, and the storage tank were done on self- help basis. CARE-Kenya agreed to supply the balance of the remaining pipes. By 1978, the community had built a pump house, had a pump and a very well-constructed tank. Water was pumped from Thiririka River. A trench had been dug to Kiganjo market. The ministry agreed to provide the necessary pipes.

Kagera self-help Water Supply: This was in Ngenda location. People of this community intended to source water from Theta River. They constructed a pump house and installed a pump, however, heavy rains washed it away. They constructed another pump sourcing water from a well. They had constructed two water tanks by 1978. The ministry agreed to send an engineer to design a pump house and trenches. It also approved 400,000 shillings worth pipes and 500,000 shillings in cash assistance. It then designed the part one of project, which included the intake works, the rising main pipes and the 20,000 gallon masonry tank. Viak consulting engineers made its design, and the Ministry of Water Development did the estimate. It was planned that all the small projects would eventually be linked in time with the main Thiririka, Ndarugu and Karimenu Schemes⁸⁴².

Kanyariri water project: A borehole and a spring tributary of Gatara River supplied water for the Kanyariri-Gitaru water project. It was large and served a large number of people with their livestock in an area of 11.2-kilometre square. However, more water for domestic and horticultural agriculture use was required to meet the high demand. Numerous low hills, river valleys, and abundant vegetation characterized

840 Njoka S.N (1978). Gatundu Water Supply, Thiririka Water Project. Kenya National Archives, RP/21/24, Ref: CA/AIR/CM/77-78/146. 27th February 1978.

841 Njoka S.N, (1978). Gatundu Water Supply, Thiririka Water Project. Kenya National Archives, RP/21/24, Ref: CA/AIR/CM/77-78/146. 27th February 1978.

842 Muigai N (1978). Self-Help Water Projects in Gatundu. Kenya National Archives, RP/21/24, Ref: WAT/49/3. 21st December 1978.

the area. Gatara River and its tributaries provided excellent drainage. Local precipitation was the principal source of recharge while the topmost dark brown soil facilitated percolation.

In the efforts to improve the supply, Mukiri, a geologist, recommended boreholes at five different sites close to the project. At the first site, water could be attained at a depth between 61 and 107 metres. At site two, it was attainable at a depth between 86 and 122 metres. Site three between 107 and 221 metres, while site four and five at an average of 70 metres⁸⁴³.

Munyu Water supply: The government seriously considered the question of supplying water to a greater portion of the arid areas of Munyu and the adjoining areas of Gatwanyaga and Ndarugu and put a lot of money into the project by 1980. For the project to kick off, the Ministry of Water Development requested the Archdiocese for financial assistance in the initial stages of the project⁸⁴⁴.

Kiambaa Water Project: In May 1980, some funds for Kiambaa water project were transferred to the DC Kiambu and by August works on the Kiambaa dam had started. Mr. Ndiho, on behalf of the Permanent secretary assured the chairman for the project of continuous update on the project developments⁸⁴⁵.

Komothai Water Project: In June 1980, Hon. A.K. Magugu, the Minister for Health and the permanent secretary in the Ministry of Water Development discussed the Komothai water project. After checking with the consulting engineers and the designers, the minister found that designs for the project were progressing well and phase one had been ready for implementation for over two years. In September, the Minister consulted the PS once again for more practical start of phase one of the project while awaiting the completion of designs for other phases. The minister was deeply concerned for the progress of the project⁸⁴⁶.

Kabete Location Joint Water Project: Kabete location had nine separate self-help water projects all steered by different committees by 1980. Consequently, a joint committee was formed to coordinate the projects. The committee members for the

843 Mukiri Z (1978). Hydro Geological Report. Kenya National Archives, RP/21/24, Ref: WAT/49/3/115. 10th July 1978.

844 Fr. Njuguna D (1980). Project No. 141-1/53 Z 2518-Water Supply for Munyu. Kenya National Archives, RP/21/24, Ref: US/E.D. WAT/49/3. 31st March 1980.

845 Ndiho A.N (1980). Kiambaa Water Project. Kenya National Archives, RP/21/24, Ref: WAT/49/3 II. 11th August 1980.

846 Magugu A.K, (1980). Komothai Water Project Kenya National Archives, RP/21/24, Ref: WAT/49/3, KOMOTHAI/WATER/PRO/1. 15th September 1980.

separate projects were co-opted to the main committee with a new chairman. The committee operated well for some time until in November when an opposition committee was formed and the problems started. The parallel committee confiscated the keys to the borehole and controlled the use of water; this adversely affected the progress of the scheme⁸⁴⁷.

The provision of unskilled labour was reported good but with slackness in Mwimuto, King'eero and Githiga projects. Cases of illegal connections by members of the community were reported. As a result, the quantity of water available by 1980 could not suffice individual connections in every home. A consulting firm of engineers was looking into possibilities of extra boreholes. Mr. Munoru, the head of self-help section, thought it desirable if private connections were left in the hands of the officer in charge who would discuss the matter with the joint committee. Munoru further noted that the projects were individually designed and there was no layout showing all the projects together, which further complicated private connection issue⁸⁴⁸.

By the end of October 1980, Gikuni water project had approximately 80% of the pipelines laid down. The project was connected to Nyathuma and Gathiga boreholes. An additional 30,000-gallon tank was proposed for building together with staff quarter under contract. Nyathuma water project had very promising spring sources. However, a lot of irrigation was practiced from the very source hence limiting the available water. 95% of all the piping had been completed. The system had been interconnected to Karura ka Nyungu Gikuni, Githiga, Mwimuto, Wangige and Kibichiku for operational efficiency⁸⁴⁹.

Wangige water project had not been authorized to take off nor had the pipes been laid by October 1980. About 90% of Kibichiku water project piping had been done. A line of two inches diameter was to be replaced with a line of four inches diameter to augment Kibichiku supply. This was meant to reduce the silting at the intake. By October 1980, laying pipes had been completed at Chura water project. A new borehole was recommended in order to augment the supply.

Mwimuto water project was interconnected with Nyathuna and had a promising source. Eighty percent of the trenching work had been done and pipes had been delivered to the site. Kanyongo water Project was the smallest water project within Kabete joint water project. Only twenty percent of the piping had been done by October. Completion of all pipelining was expected by mid-November. Fifty percent

847 Munoru P.G, (1980). Kabete Location Water Project-Progress Report Kenya National Archives, RP/21/24, Ref: WAT/49/3. 13th November 1980.

848 Munoru P.G (1980). Kabete Location Water Project-Progress Report Kenya National Archives, RP/21/24, Ref: WAT/49/3. 13th November 1980.

849 Munoru P.G (1980). Kabete Location Water Project-Progress Report Kenya National Archives, RP/21/24, Ref: WAT/49/3. 13th November 1980.

of the piping at King'eero water project had been laid and others delivered by 1980. Although trenching had not been done, it was expected to be completed immediately. Installation of boreholes and storage tanks was in the process and expected to take less than two months. Mr. Munoru indicated that the self-help section was committed to see the successful completion of the projects not yet completed⁸⁵⁰.

By 1981, there were seven operational water projects and nineteen projects under construction in Kikuyu location. These included the government and the self-help water projects. Springs and boreholes formed the major source for the piped supply, for adequate supply however, some projects had more than three boreholes. At this time, the ministry was taking over the county council owned water projects for improvements. In most projects, there were plans to install an electric pump though this depended upon the availability of electricity⁸⁵¹.

Mudavadi, a Member of Parliament and a minister for water development presented a progress report of Kikuyu water projects to the minister for constitutional and home affairs, Charles Njonjo. The report involved twenty-six water works. It evaluated the progress of every project in the location, project both operational and those at design/construction level⁸⁵².

Operational projects: Karai water project was operational with problems due to off takes from the boreholes' rising main. The consumers connected to distribution system from the tank experienced many problems. The redesign of the system to allow water to be distributed from the tank was at hand. The ministry operated Kikuyu water supply. The extension to the trading centre was already complete by 1981 and a 50,000-gallon tank had to be constructed at Alliance high school before the connection to the centre was made⁸⁵³.

The ministry of water development in 1980 took over the operation of Ondiri water project. By 1981, it had installed the rising main and the distribution mains. The ministry also took over Rumwe water project in 1980 and awarded the contract for the construction of 136 m³ tank to Nganjogi Construction Company. At the same time, it was in the process of purchasing a new submersible pump for the project. The chief and the people were expected to sort out the land issues for construction of double grade 9 houses immediately with the availability of funding.

850 Munoru P.G (1980). Kabete Location Water Project-Progress Report Kenya National Archives, RP/21/24, Ref: WAT/49/3. 13th November 1980.

851 Mudavadi M.B (1981). Kikuyu Water Projects. Kenya National Archives, RP/21/24, Ref: WAT/49/11/273. 28th January 1981.

852 Mudavadi M.B (1981). Kikuyu Water Projects. Kenya National Archives, RP/21/24, Ref: WAT/49/3 11/273. 28th January 1981.

853 Mudavadi M.B (1981). Kikuyu Water Projects. Kenya National Archives, RP/21/24, Ref: WAT/49/3 11/273. 28th January 1981.

By 1981, the construction of a roof slab for Uthiru self-help water project was in progress. The flooding of the pump during the rains caused some delay in the work. The committee intended to apply for the power for the project operation from East Africa Power and Lighting Company. A self-help group also operated Kinoo water project. It constructed a pump and the plastering was in progress. The area was to be fenced instead of covering the pump and the raising mains; DDC was to provide the money for the works. Evaluation for the pumping units was at hand in 1981⁸⁵⁴.

The water for Gitaru-Kanyariri water project was not adequate hence; five boreholes were drilled in the area, three boreholes in Kanyariri sub location. East Africa power and lighting company paid 51,195 shillings for the power extension to the pumps. The ministry undertook to equip the boreholes and provide a pump for pumping water from the river.

Projects under design/construction: The intake and the raising main for Kahuhu water project were complete by 1981. After the testing of the borehole and the power supply, an electric pump was to be supplied to the borehole. A 136 m³ tank tendered for construction to M/S. Nganjogi Construction Company was also to be installed.

Jet Scheme was a county council water project. The district water office was in the process of taking over the project for rehabilitation. Sigona, Karinde, and Kerwa boreholes were under construction. Lusigeti area (Ndeiya Karai) borehole was found dry and a new site was being sought. Thogoto water project was partly operational under a self-help group. 80,000 shillings from the DDC was being used to buy pump and pipes. Bariniki water project covered a very small area but provided adequate water. Nachu water scheme was under county council. Mahiga project was new and operating well. It was allocated 170,000 shillings by the DDC for construction of masonry and elevated steel storage tank. It was contracted to Davis and Shirtliff consultants⁸⁵⁵.

Nyathuga/Kikuni Water project had 27 kilometres of pipeline already done by 1981. Ten kilometres remained undone. The project was operational and the ministry plumbers were making individual connections. At Wangige, a store and an office for staff were under construction. Kiambu county council owned Wangige water project and the ministry was looking forward for the handing over from the council. Githiga water project had 5.7 kilometres of pipeline laid. Three and a half more kilometres remained. It had a pump house fencing and submersible borehole pump installed. Electrical installation was in progress.

854 Mudavadi M.B (1981). Kikuyu Water Projects. Kenya National Archives, RP/21/24, Ref: WAT/49/3 11/273. 28th January 1981.

855 Mudavadi M.B (1981). Kikuyu Water Projects. Kenya National Archives, RP/21/24, Ref: WAT/49/3 11/273. 28th January 1981.

All the 5-kilometre pipelines for Kibichiku water project had been laid by 1981. Other minor works of fixing the air valves, valve chambers washout and other replacements were yet to be done. Chura water project pipelines had all been installed and only other minor works remained by 1981. Once completed, electrical installation was planned. Pipe laying at Mwimuto water project was almost complete; its pump house was yet to be constructed. Kanyongo water project had its 0.5-kilometre of 1.32 km pipeline undone, its pump house, installation of submersible borehole pump had been completed. Electrical installation was in progress. About nine out of ten kilometre pipeline out of ten kilometres at Kingeroo water project had been done. Trenching of the remainder was in progress. Pump house, fencing, installation of submersible borehole pump and gantry had been completed⁸⁵⁶. The Kiambu District water development activities summary is presented in Table 3.42.

Table 3.42: Ministry of water development activities in Kiambu District (1981-85)

Government Schemes			
Project Name	Location	Project cost (million KES)	Remarks
Karimenu water supply	Gatundu division	30	75% complete, 15.4 million shillings utilized
Ndaragu water supply	Gatundu division	10	Phase I operating, phase II under construction. Plans to procure new pumping equipment finalized. 5 million so far spent
Bathi water supply, phase I and II	Limuru/Kikuyu divisions	12	Complete and operating
Limuru/Uplands water supply	Limuru and Uplands area	7.3	Complete but not operational
Thiririka water supply	Gatundu division	26	Intake works complete, construction of treatment works ongoing. Ten million spent.
Munyu water supply	Thika division	21	Design complete
		Total 106.3	
SELF-HELP PROJECTS			
Project Name	Location	Project cost (million KES)	Remarks
1. Nyaga water supply	Githunguri division	Approximately 4	Started in 1973 and funded EEC (EU). design for the treatment work in progress

⁸⁵⁶ Mudavadi M.B (1981). Kikuyu Water Projects. Kenya National Archives, RP/21/24, Ref: WAT /49/3 11/273. 28th January 1981.

2. Ting'ang'a supply	Kiambaa division		Started in February 1981. Funded by Ministry of Water Development and S/H. Cost unknown so far
4. Upper Githiga, Githiha, Githiga Gathaithi	Githunguri division	0.872	Projects were merged into one and recommended for RWS (Rural Water Supply) Programme V
Riuku and Ikinu	Riuku Ikinu sub location	1.6	About 50% of the work is started
Thimbigua water project	Kiambaa division	0.5	Borehole started in 1976 but had high fluorine content. Further investigations underway
Gitaru/Kanyariri water project	Kikuyu division		CARE donated 50,000 DDC 72,000 also S/H groups contributed.
Kanunga water project	Kiambaa division	-	Had organisational setbacks. Got donations from Dutch Commodity Aid
Ndumberi	Kiambaa division	-	Had organisational problem. Construction was in progress.
Kiambaa division water supply project	Kiambaa division	-	Under design by consultants
Kabuku water supply	Limuru division	-	Started in 1972. Funded by S/H, DDC and Dutch Commodity. 75% done
Muthiga water project	Kinoo location	0.435	Project complete, donors DDC&S/H groups while Freedom from Hunger Council donated 280,000
Ondiri/Rumwe	Kikuyu division	0.050	Construction hindered by lack of funds
Baraniki water project	Kikuyu division	0.138	Complete
Kibichiku water project	Kabete area	-	Engulfed by Kabete joint water project
Kimathi water project	Githunguri location	0.427	Started in 1972 to serve 11,200 persons. 98% complete
Kiaria water project	Githunguri location	0.263	Serves 45,000 persons. Project complete

Problems encountered

Leadership problems; The joint committee elected to head the amalgamated nine water projects in Kabete location joint water project experienced rivalry from a parallel committee which took over the control and management of the scheme

illegally. This derailed the progress. Organisational problems hindered development of Kanunga water projects.

Lack of material and persistent delays in delivery of materials and frequent breakdown of mechanical and transport plant delayed works in some projects.

Slackness and low morale from the unskilled labour, which delayed progress was encountered at Mwimuto, King'eero and Githiga.

Illegal connections; by 1981 more than six illegal connections were made in Kabete location alone. This uncontrolled usage led to wastage and reduced the amount of flow.

In some areas, for instance Ndeiya, boreholes were sunk and found dry. This caused a waste of labour, money and time. Sometime the water had a lot of fluorine significantly hindering palatability.

Kiambu was an urban centre and a district headquarters for Kiambu District, Central Province. It is located 17km north of Nairobi. By 1983, the town was supplied from 6 boreholes and additional bulk supply from Nairobi City Council Chania Pipeline. The fluoride content in the ground water from some of the boreholes exceeded the recommended level the distribution was by gravity and served Kanunga village from Trench's spring. The projected population and water demand figures are shown in Table 3.43.

Table 3.43: Population and water demand projections in Kiambu by 1980

Year	1980	1990	1995
Population	35500	49600	58800
Water demand (m ³ per day)	2195	3200	3900

The estimated capital cost as per November 1977 was KES 16million.

Kiambu was included in the list of projects proposed to be financed by the IBRD, but the final decision was awaited. It was recommended that Kiambu water supply was left out of the projects to be considered for inclusion in the new MUWS programme for 1984-88. NORAD was expected to finance in case the scheme was not financed by the IBRD⁸⁵⁷.

Tharaka Water Supply and Sanitation project: This was a well-planned and coordinated project with several phases. The initial preparation of the project background document was undertaken by the ministry of water development, ministry

857 Hunn G. (1983). Progress Report About Water Projects included in the Minor Urban Water Supply Programme. NORAD –Coordinator/MOWD. Nairobi Ref: WD/1/2/5. 10th June 1983.

of health and ministry of culture and social services. The funding was received from SIDA. The major phases were: Pilot project planning between 1987 and 1988; the Marimanti Pilot project; physical implementation of Marimanti Project; general mobilisation and camp construction between 1988 and 1990, the “Greater Tharaka” study in 1990 and the expanded Tharaka/New concentration area project in 1992.

By 1993, the project had had a total of 218 boreholes drilled, 50 ferro-cement tanks with a capacity of 1325 m³ for roof catchment constructed, 4 rock catchment projects completed with a total storage capacity of approximately 1430 m³. In addition there were two spring protection works completed and 19000 adults and 7000 secondary and primary pupils reached with health education⁸⁵⁸.

Rusinga Island Water Supply: Rusinga water supply was completed in 1983. It served one secondary school and a health centre. The total population served by 1987 was about 420 people. This water supply was constructed NORAD through the volunteer programme. It was rehabilitated in 1987 by NORAD at a cost of KES 118,000. The school and the health centre managed the supply. The larger community’s participation was therefore limited⁸⁵⁹.

Ingotse Hydram Project: Ingotse hydram piped scheme is a community-based project. The project started in 1987, but due to the breakdown of the hydram, the project became dormant, as the ram could not be repaired. The community/ consumers thereafter approached the Kenya-Finland Western Water Supply Programme (KFWWSP) to assist them with any necessary technical and financial materials. The programme took feasibility studies for the area in question in order to solicit for the assistance required⁸⁶⁰.

The project area was about 8 km to the North West of Kakamega Town, along Lurambi- Nambacha murram road, in Ingotse sub-location of Kakamega district in Western province. It was characterized by numerous unprotected springs, which were the major source of water to the community. One of the protected springs was proposed as an intake for the hydram scheme. The unprotected springs were individually owned while the protected springs were communal. There were also a few water points around the project area. The proposed Ingotse hydram project was intended to serve a population of about 500 persons at by 1992⁸⁶¹.

Amukura Hills Water Supply: Amukura hills water supply was a community managed gravity scheme. It traversed Aderema and Akoreet sub locations both of

858 Proceedings of the Tharaka Leaders’ Seminar held at Thuci River Lodge from 16th to 17th August 1993, Tharaka, Kenya.

859 Gathuo B. (1987). Rehabilitation of Rusinga Island Water Supply. Nairobi, Kenya.

860 Omino, M. O. (1992). Ingotse Hydram Design Report, Kenya-Finland Western Water Supply Programme, Ministry of Water Development, Kenya.

861 Omino, M. O. (1992). Ingotse Hydram Design Report, Kenya-Finland Western Water Supply Programme, Ministry of Water Development, Kenya.

Akoreet location of Amukura division in Teso district, covering an approximate area of 6 km². The sources of water for the scheme were two springs originating from Amukura hills. It was constructed in 1987 by Kefinco under Kenya – Finland western water supply programme together with the community to initially serve Akatogoroit primary school and the surrounding population.

Scheme rehabilitation and extension was done in 1992 by the then Ministry of Water Development with funding from Rural Development Fund (RDF) and services extended to Lukolis market. By 1992, the scheme was operational with a total number of 26 connections and that served about a thousand people though it was designed to serve a population of 1500. The problem facing the scheme included poor management, lack of funds, leakage and frequent pipe bursts, lack of storage facilities and lack of skilled personnel. Water was not treated in any way though required. The medium potential areas of western Kenya, communal water points furnished a valuable service. In most cases a washing slab was provided. Parents frequently took the opportunity to wash themselves and their children in 1983⁸⁶².

The intake works of the water supply consisted of a twin protected spring, two clear water sumps, two-inch GS pipes 1000m long gravity main, incomplete 50 m³ storage tank and four 2m³ break pressure tanks⁸⁶³.

Ngoli Community Water Supply Project: Ngoli community water project was located in Sirisia division of Bungoma district. The project was intended to serve the community of Namwela including Chwele and Namwela secondary schools two primary schools a clinic and Namwela market after completion. By 1992, the project served the two secondary schools and a clinic. Figure 3.54 demonstrates a community water supply in Ngoli.

862 Hunn G (1983). Progress Report about Water Projects Included in the Minor Urban Water Supply Programme. NORAD, Nairobi.

863 Community Water Supply Management Project (2003). Draft Completion Report (January 1997 – June 2003). Ministry of Water Resources Management and Development and Embassy of Finland, Nairobi, Kenya. June 17th 2003.



Figure 3.54: A community water supply⁸⁶⁴

The source of the water supply was a spring with a pumping unit consisting of pump that pumped water to the two secondary schools and a clinic. The rising main was made of uPVC measuring 2' diameter for 3 Km. The intake structures comprised of one protected spring, one clear water sump, intake screen, Over flow pipe and a communal water point. The only treatment required was chlorinating, especially when the schools re-opened after closure. During the closure period the water was likely to be contaminated due to non-usage⁸⁶⁵.

Onanan-Funyula Community Water Project: Funyula Nangina water supply was situated in Funyula Division of Busia District. The area is characterized by hills that run from Northeast to southwest culminating at port Victoria. There were numerous streams that served as water sources for the local people. The water scheme covered approximate area of 8km² and basically served Funyula town council, Nangina complex and the surrounding villages comprising parts of Odiado Nangosia and Nambototo locations.

The intake was a spring that was operated with a masonry sump covered with steel plate with a retaining wall below the masonry tank. The collection chamber box

864 Community Water Supply Management Project (2003). Draft Completion Report (January 1997 – June 2003). Ministry of Water Resources Management and Development and Embassy of Finland, Nairobi, Kenya. June 17th 2003.

865 Community Water Supply Management Project (2003). Draft Completion Report (January 1997 – June 2003). Ministry of Water Resources Management and Development and Embassy of Finland, Nairobi, Kenya. June 17th 2003.

was 1km² into which the spring water flows and penetrated through the perforated PVC pipes. From the collection box, where 25mm thick stones were spread, the water gravitated through a 160mm uPVC pipe into 50 m³ underground masonry tank (sump) from where the water was finally sucked through 20 No. 80mm diameter galvanized iron suction lines.

The pumping station comprised, pump house, chemical house, solution tanks and operator's house. There were twenty solutions tanks of fibre glass each of 500 litres capacities. Connected to the solution tanks were facilities for mechanical disinfecting. The pump house housed a pumping room and a chemical storage. There was a borehole with a 110mm diameter casing within the pumping station. The yield of this borehole was not definitely known although it was suspected to have the same source with the spring intake⁸⁶⁶.

The rising main was 100mm diameter and 110mm diameter GI and uPVC pipes respectively. The rising main was designed for a flow of 5.86 l/s. It was 700m long starting from the pumping station to a ground tank of an altitude of 1280m above sea level. Along the rising main, there was a single air valve and washout. The distribution system mainly covered Funyula Town; the Nangina Complex extending southeast wards up to the school for the mentally handicapped. Also included within the distribution network were Nangina Family helper project and the six water kiosks, which were mainly located at the extreme ends of the project area.

The main storage tank for the water supply was a 100 m³ ground masonry tank situated on Nangosia Hills. Water was pumped into this tank by the high lift pumps through a 100mm diameter rising main⁸⁶⁷.

Butula Water Supply: Butula rural centre had a water supply consisting of a dam as a water source, an old pumping unit, an 8 m³ storage tank and limited reticulation. The quality of the water in the dam is poor and the pumped amount of the untreated water is insufficient. All the facilities were in bad condition⁸⁶⁸.

The scheme was handed over in December 1985 to the community by the Ministry of water development after rehabilitation. Consumer connections were increased by 107 pcs, an elevated tank of 100m³ capacity and a pumping house,

866 Community Water Supply Management Project (2003). Draft Completion Report (January 1997 – June 2003). Ministry of Water Resources Management and Development and Embassy of Finland, Nairobi, Kenya. June 17th 2003.

867 Community Water Supply Management Project (2003). Draft Completion Report (January 1997 – June 2003). Ministry of Water Resources Management and Development and Embassy of Finland, Nairobi, Kenya. June 17th 2003.

868 Kefinco (1985). Final Report. Rural Water Supply Development Project in Western Province of Kenya. First Implementation Phase November 1983 – December 1985. Ministry of Water Development, Kenya and Ministry for Foreign Affairs, Finland.

office, stores, housing facilities for 4 units, a generator (8.0 kVA) and a pump (7.5 m³/h, 63m wp)⁸⁶⁹.

Chwele Water Supply: In 1985, the preliminary design report of Chwele (western province) water supply was prepared. The small centre had a calculated water demand of 60 m³/day, which was designed to be covered by two boreholes equipped with solar powered submersible pumps. A ground tank and reticulation of approximate length of 2000 metres are needed⁸⁷⁰. As at 1985 the construction had not begun.

Shikusa Water Supply: The old treatment plant by a small brook had been down for more than two years by 1985. Institutes were served by hand pumps constructed by the project. The plant met the demand of water, which was about 100 m³/d on average, and was capable of producing 200 m³/d only increasing pumping hours. The operation was very reliable⁸⁷¹.

Malava Water Supply: The Malava water scheme started in 1960 with a request by certain farmers and traders of the Malava area for a piped water supply⁸⁷². The Malava water scheme was conceived and implemented by the Land Development Board as one of the supplies for non-scheduled areas under the then African Land development (ALDEV). The Assistant Engineer ALDEV, Johnstone was responsible for the survey, preliminary design and eventually the implementation of this water scheme. As at 1960 the scheme was at design stage with only provisional costing of the scheme.

Johnstone 1960 camped at Malava from 17th October 1960 when he started the detailed survey for the pipeline route. A baraza was to be held to discuss the matter of the route of the pipeline. At the baraza, it was to be decided whether the pipeline was to run across land or by the boundaries. The comprehensive survey would enable a detailed costing of the scheme⁸⁷³.

Classen in 1961 wrote a report on the Malava water supply. In his report it was clear that the scheme was to provide for a supply of raw water to a group of small holdings at Malava (Table 3.44).

869 Kefinco (1985). Final Report. Rural Water Supply Development Project in Western Province of Kenya. First Implementation Phase November 1983 – December 1985. Ministry of Water Development, Kenya and Ministry for Foreign Affairs, Finland.

870 Kefinco (1985). Final Report. Rural Water Supply Development Project in Western Province of Kenya. First Implementation Phase November 1983 – December 1985. Ministry of Water Development, Kenya and Ministry for Foreign Affairs, Finland.

871 Kefinco (1985). Final Report. Rural Water Supply Development Project in Western Province of Kenya. First Implementation Phase November 1983 – December 1985. Ministry of Water Development, Kenya and Ministry for Foreign Affairs, Finland.

872 Colony and protectorate of Kenya, (1960-1961). Nyanza North organization, Malava water scheme completion report. Kenya national Archives, Ref. No. DC/KMG/2/26/47, Nairobi, Kenya.

873 Colony and protectorate of Kenya, (1960-1961). Nyanza North organization, Malava water scheme completion report. Kenya national Archives, Ref. No. DC/KMG/2/26/47, Nairobi, Kenya.

Table 3.44: Design coverage of Malava water supply by 1961

Area of requirement	Amount required (litres per day)
86 farms	455
1 chiefs centre	1363
1 police post	909
1 market	2273
1 health centre	22,739 "
1 school	1818
Total	29557

NB: Total Pumping was 54,553 litres per day

The water source was a spring with 6 hr pumping to a 91m³ tank sited on high ground on the right of Kakamega/Eldoret road. From the point where water would be reticulated throughout the scheme, each farm draw-off pipe would terminate in a concrete tank controlled by a ball valve, with a capacity of 455 litres.

From the letter by the DC North Nyanza Mr. Randle, to the Executive Officer, Land Development Board (non-scheduled areas), several issues could be discerned; that in the original planning of the scheme it was agreed that the Kabras Location Council would provide 1000 pounds which would be matched with another 1000 pounds from the ALDEV funds while the remaining balance of 3,887 pounds would have to be obtained as a loan repayable in 15 years of equal annual instalments of principal plus interest at 6.5%. The repayment rate was 32.16 pounds per month. The loan was to be obtained from North Nyanza Joint ALDEV Board. The scheme had already received approval from the District agricultural committee and the P.A.C in 1960. Mr. Classen undertook to build the design of the scheme⁸⁷⁴.

The actual construction work on Malava water supply begun on 3rd May 1961 and was supervised by Ass. Engineer ALDEV, Mr. Johnstone. Twenty labourers were employed on the work for KES 45 per day. Each farmer or person who wished to be supplied with water from the scheme would have to apply in writing. A connection was then made to his farm or compound at his cost. Those farmers who were unable to meet the cost immediately were given loans which they would pay thereafter. Each farm was to be fitted with 455 litre tank, cattle watering trough and a stand pipe near the house. The procedure adopted was to ensure that the cost of water supplied was at minimum⁸⁷⁵.

874 Colony and protectorate of Kenya (1960-1961). Nyanza North organization, Malava Water Scheme Completion Report. Kenya national Archives, Ref. No. DC/KMG/2/26/47, Nairobi, Kenya.

875 Colony and protectorate of Kenya (1960-1961). Nyanza North organization, Malava Water Scheme Completion Report. Kenya national Archives, Ref. No. DC/KMG/2/26/47, Nairobi, Kenya.

The scheme was completed on 31st October 1961 and handed over to the Kabras Location council on 2nd November 1961. All connections had been installed with metres, which were to start recording consumption from 1st November 1961.

By 1966 the South Kabras location council had fallen into an acute financial position due to non-payment of water rates. The water which was being supplied to the Malava Market traders, Health Centre, Chiefs centre and MoW camp was paid for based on metre readings.

However out of another 45 farms supplied with water only 30 were using the water and among the 30 only 5 were paying for the water use regularly. The Location council was thus losing KES 5,880 every year on payment of water development loan and was in deficit of KES 51,034.

Moding water supply: This was a small scheme operated by the Busia county council. It had served the Moding centre and a school with spring water since 1972. For a long time, however, the operation had been very irregular due to the poor condition of the facilities. A new consumer health centre was constructed in Moding by the Kenya–Finland primary health care programme in 1985⁸⁷⁶. The scheme was rehabilitated in 1985 under the Kenya–Finland Rural Water Development project in the Western Province of Kenya and it involved:

- 1) Design population: 700
- 2) Design capacity: 42 m³/day
- 3) Water source: Protected spring
- 4) Reticulation: 63 mm PVC, Length 180 m, 32 m PEL, length 120 m
- 5) Consumer connections: four individual and one kiosk
- 6) Elevated Tank: Volume 24 m³
- 7) Buildings: Pumping house 18 m²
- 8) Equipment: Repair of the present diesel powered pump
- 9) Start-up of the water supply was in December 1985.

Maseno Water Supply: The land on which Maseno was built was originally alienated as a sisal concession. The concessionaires failed to make good use of it and land was reverted to the Crown. About 100 acres were sold to the CMS (then the Maseno Mission School) and the Government retained the Rest. The area was in the middle of a densely populated native reserve, where acquisition of land was

⁸⁷⁶ Kefinco (1985). Final Report. Rural Water Supply Development Project in Western Province of Kenya. First Implementation Phase November 1983 – December 1985. Ministry of Water Development, Kenya and Ministry for Foreign Affairs, Finland.

matter of greatest difficulty. In a reconnaissance report of Maseno done by Scott 1944, he describes it as⁸⁷⁷;

“High and healthy, and would make excellent site for a large native administrative and educational centre if it had sufficient water”.

A 1944 study established that the soil cover was about 15 metres of red soil. The underlying rock was granite, fresh and apparently very impermeable, hence the numerous springs and swamps. The rain sunk into the soil and flowed downwards to the fresh granite. It could penetrate the granite, so it flowed as springs at low points. None of the springs were deep seated and hence dried up during prolonged drought periods⁸⁷⁸.

The ground was long ridge sloping gently from NE to SW and the ridge had a broad top width, with a fall along the crest of about 61 metres spread over a kilometre and half. The land sloped down to the springs and swampy water courses on either side of the central ridge. Along the high NE boundary was a line of granite hills at right angles to the ridge. The slopes of hills were densely populated and cultivated to the summit.

Maseno water supply was contemplated as early as 1944. The proposed Agricultural school and Teachers training institution at Maseno required considerable amount of water supply. The water supply to the veterinary station which existed at Maseno at that time was inadequate and that the drought which was ongoing in the year had exposed the vulnerability of the Centre to water shortage. The Veterinary station depended on a spring yielding 13.2 m³ per day, which it shared with the natives⁸⁷⁹.

Considerable sums had been voted for the development of Maseno as an Agricultural and veterinary station but no consideration for water supply had been made. The Divisional Engineer was apprehensive that the springs would provide reliable water supply urged for an investigation into a proper water supply⁸⁸⁰.

It would seem quite within the bounds of possibility that the result of such an investigation that the result of this investigation would lead to the abandoning of the plans for developing Maseno.

877 Colony and Protectorate of Kenya (1943 – 1945). Maseno Agricultural Training College. Kenya National Archives, Ref. No. PC/NZA/3/2/124, Nairobi, Kenya.

878 Colony and Protectorate of Kenya (1943 – 1945). Maseno Agricultural Training College. Kenya National Archives, Ref. No. PC/NZA/3/2/124, Nairobi, Kenya.

879 Colony and Protectorate of Kenya, (1943 – 1945). Maseno Agricultural Training College. Kenya National Archives, Ref. No. PC/NZA/3/2/124, Nairobi, Kenya.

880 Colony and Protectorate of Kenya (1943 – 1945). Maseno Agricultural Training College. Kenya National Archives, Ref. No. PC/NZA/3/2/124, Nairobi, Kenya.

Scott underscores the importance of water supplies to the development of Townships, schools, hospitals, markets, trading and administrative centres.

Maseno was being served by several springs located within the native reserve. One of the springs had been enclosed and piped to the CMS Hospital. A second one was piped to the CMS School. A third spring formed a head of the swamp from which the veterinary training centre pumped its water. All institutions had had water shortages during the drought in 1944⁸⁸¹.

Options for water supply

Water boring: No good result would yield from boring owing to thin soil cover, restricted recharge area.

Springs: the water supply that existed in 1944 was dependent on spring and as such they were limited by the same reasons as for boring.

Rivers: the water supply at Maseno would have to be dependent on supply from rivers if it were to grow to a fully-fledged township and administrative centre. Scott 1944 proposed that tapping water from the Edzawa River 8 kilometres away would yield sufficient water for the township.

Investigations and survey for water supply: The major impediment to installation of a water supply in Maseno was the acquisition of a surveyor to undertake the survey of the area and draw contour maps which could then be used to find a suitable intake for a preferred gravity supply. At the time, many water supplies were being investigated and all the surveyors who were mainly Indian were fully engaged in work elsewhere. The priority of development given to the water supply was very important. For example a water supply under priority A was prime for development, priority B meant it could be investigated and priority C meant that it was actually not needed at the time⁸⁸².

A private arrangement was thus made to employ Col. Gamlen to carry out the investigations at a rate of five guineas (is a coin of approximately one quarter ounce of gold that was minted in the Kingdom of England and later in the Kingdom of Great Britain and the United Kingdom between 1663 and 1814) a day, which was to end on 15th November 1944. The Director of public works Mr. Tetley, in his letter of 30th January 1945, to both Directors of Agriculture and Education, confirms

881 Colony and Protectorate of Kenya (1943 – 1945). Maseno Agricultural Training College. Kenya National Archives, Ref. No. PC/NZA/3/2/124, Nairobi, Kenya.

882 Colony and Protectorate of Kenya (1943 – 1945). Maseno Agricultural Training College. Kenya National Archives, Ref. No. PC/NZA/3/2/124, Nairobi, Kenya.

the completion of the survey from the intake to the service tank. The cost of the pumping scheme was being prepared at the time.

The scheme: After the survey, the Zaaba River which is a tributary of the Edzawa River was selected as the suitable. A hydrostat was installed to operate during high flows when water has enough head to drive the ram, at the same time a pump and engine were put in as stand by during low flows. A total of 136m³ were expected to be pumped each day, comprising a flow of 137 m³ as compared to 4342 m³ which was the flow of the river at the time.

During the design it was envisaged that during dry seasons the mills downstream would be deprived of water and hence it was agreed to compensate the owners of such mills the sum of their average daily income during operations for the period when withdrawal would mean deprivation of income to the mill owners. It is surprising that a mill would make a daily income of one shilling per day at that time and this was considered a modest income.

Following the survey, several recommendations were proposed by Col. Gamlen, one of the main conclusion was that the low flow of the Zaaba Stream was undoubtedly affected by the denudation of the catchment. Agent steps to stop soil erosion were needed to protect the catchment so as to sustain the flows of the river⁸⁸³.

By 25 June 1945, the building of the proposed training centre was suspended thus putting the water supply in a rather different light. Earlier Col. Gamlen had estimated the water demand for the township. Most of the facilities above were as earlier served with water which was poor during the dry season. The divisional engineer proposed that rainwater storage by storage tanks to augment the supply and satisfactorily serve the natives. A representation of estimated demand for Maseno Township by 1945 is mad in Table 3.45 and 3.46.

883 Colony and Protectorate of Kenya (1943 – 1945). Maseno Agricultural Training College. Kenya National Archives, Ref. No. PC/NZA/3/2/124, Nairobi, Kenya.

Table 3.45: Estimated water demand for Maseno Township by 1945

	Europeans	European dependants	Native staff	Trainees	Animals	Irrigation
CMS school	5	16	100	350	30	
CMS Hospital	4	6	50	150		
Veterinary	3	7	40	60	350	
Agricultural	3	7	40	60	50	
Tree nursery						2,000
Dispensary	2	2	20			
Teachers	3	5	40	60	12	
Total	20	43	290	680	442	
Gallons	3,150		14,550		3,420	2,000
Total gallons per day = 23,120						

A new problem presented itself in the form of the new proposed agricultural school, whose water needs was estimated.

Table 3.46: Estimated water demand for the proposed Maseno agricultural school

Consumer type	Number of consumers	Water requirement (gallons per day)
Agricultural officer (with family)	3	60
African teachers (with families)	8	120
Pupils	60	900
Native staff	40	600
Animals	50	500

Considering total water demand including the anticipated demand for the proposed agricultural school, which Gamlen did not include, the overall consumption would come to 115m³ per day.

The system was designed to deliver 136m³ per day. However it is not clear when the water supply became operational⁸⁸⁴.

The surface water treatment plant had operated at a capacity of 750 m³/day, which had not satisfied the demand. This was because only one old high lift pump was available and break-downs were common. Maseno area was heavily populated and had many institutes⁸⁸⁵.

884 Colony and Protectorate of Kenya (1943 – 1945). Maseno Agricultural Training College. Kenya National Archives, Ref. No. PC/NZA/3/2/124, Nairobi, Kenya.

885 Kefinco (1985). Final Report. Rural Water Supply Development Project in Western Province of Kenya. First Implementation Phase November 1983 – December 1985. Ministry of Water Development, Kenya and Ministry for Foreign Affairs, Finland.

The augmentation with a Struja unit was designed to increase the capacity with 400 m³/day to raise the population served to 19000 people. The water source yield 1800m³/day, sufficient for 30000 people⁸⁸⁶.

The rehabilitation/augmentation included: new intake well; Struja unit including a raw water pump and pipe works; two high lift pumps, 75 m³/hour, 190 WP; and extensive pipe works at the treatment plant as illustrated in figure 3.55.

Due to the increased power demand the transformer and main switchboard had to be replaced. The plant operated with increased capacity⁸⁸⁷.

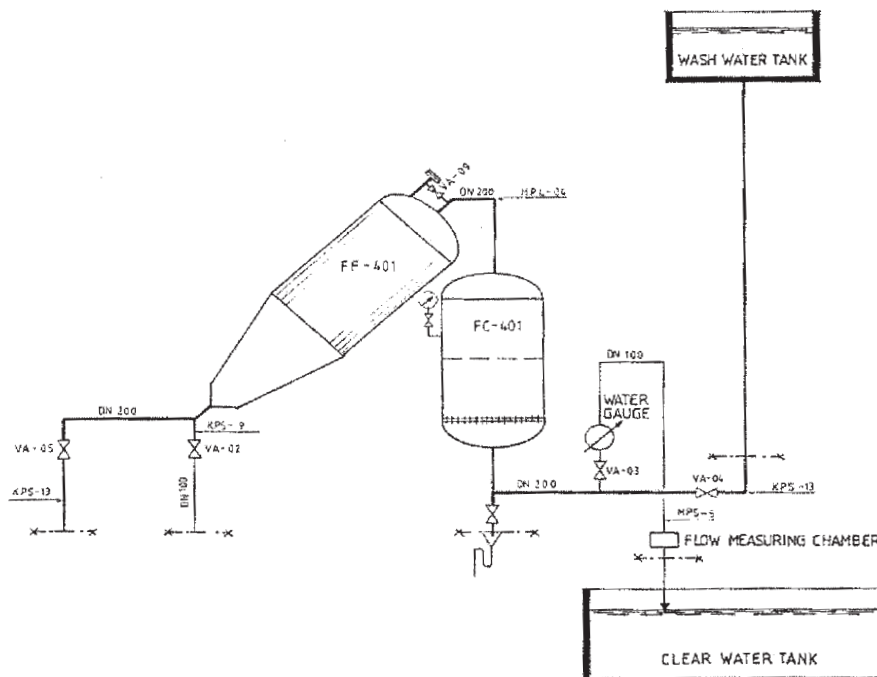

Figure 3.55: A Struja Unit designed to increase capacity by 400m³/day⁸⁸⁸

Luanda Trading Centre Water supply: The first request for piped water to be supplied to Luanda was made by Mr. Mbalanya Omwakwe, who owned Vitina mill at Luanda to the Divisional engineer (Mr. E.P.L. Wilders) through the DC. On

886 Kefinco (1985). Final Report. Rural Water Supply Development Project in Western Province of Kenya. First Implementation Phase November 1983 – December 1985. Ministry of Water Development, Kenya and Ministry for Foreign Affairs, Finland.

887 Kefinco (1985). Final Report. Rural Water Supply Development Project in Western Province of Kenya. First Implementation Phase November 1983 – December 1985. Ministry of Water Development, Kenya and Ministry for Foreign Affairs, Finland.

888 Kefinco (1985). Final Report. Rural Water Supply Development Project in Western Province of Kenya. First Implementation Phase November 1983 – December 1985. Ministry of Water Development, Kenya and Ministry for Foreign Affairs, Finland.

15th march 1949, he sought to be given a branch from the water main which was to supply Maseno Township. In his request he argues that since his 38Horse Power mill was using a considerable amount of water and that many people came there in need of drinking water, it would be prudent for the government to provide him with water from the Maseno mains. He also pointed out that the people who lived around the mill were far from the nearest well. His request was denied. It is worth noting that although his letter was received by the DC on 15th march 1949, the Engineer replied to it almost a year later on 17th February 1950⁸⁸⁹.

The matter of water supply to Luanda received a profound attention when the Indians who had settled and were trading within the town started to experience difficulty in obtaining water. The Member of Legislative Council Western area, Mr. A. Pritam wrote to the Deputy Chief Secretary, the Provincial Commissioner Nyanza and the Chief Native Commissioner⁸⁹⁰:

“It is with profound regret that I have to bring to your attention that Luanda, which is one of the oldest trading centres, is being put to great hardship due to there being no adequate or dependable arrangement for water. Hitherto the Indian merchants at Luanda used to obtain their water from adjoining streams but now the Africans through whose land passes the stream do not allow the Indian traders to take water unless they pay a cess of anything from 20 to 50 cents per tin of 4 gallons (18 litres).....

...I am told that there is plentiful water supply at Maseno and limited requirements of Luanda could be piped from this place (Member of Legislative council Western area Mr. A Pritam, 15th October 1951”

Several suggestions were made about how water supply was to be obtained including, digging of a water hole, drilling of a borehole and obtaining supply from the main which had been proposed to supply water to Yala Township from Maseno. The then Divisional Engineer Mr. I. H. Frost Wrote to the Hydraulic Engineer on 23rd Jan 1952 proposing the latter of the afore mentioned way of supplying water at Luanda⁸⁹¹.

889 Colony and Protectorate of Kenya (1949 – 1964). Maseno Water Supply – Extension to Luanda. Kenya National Archives, Ref. No. DC/KMG/2/26/36, Nairobi, Kenya.

890 Colony and Protectorate of Kenya (1949 – 1964). Maseno Water Supply – Extension to Luanda. Kenya National Archives, Ref. No. DC/KMG/2/26/36, Nairobi, Kenya.

891 Colony and Protectorate of Kenya (1949 – 1964). Maseno Water Supply – Extension to Luanda. Kenya National Archives, Ref. No. DC/KMG/2/26/36, Nairobi, Kenya.

In 1952 the investigations into the Maseno – Yala pipeline were initiated and since the pipeline was to pass close to Luanda trading centre, it was proposed that it be served from the same line. The fact that Maseno water supply was operating at only 25% of its capacity gave the proposition a cogent status. The whole proposal to supply water to Yala was to be based on the economic viability of the system thus supply subsidiary to Luanda was seen as an important one.

By October 1952 the preliminary studies into the system had been completed and had shown technical feasibility of supplying both Yala Township and Luanda Trading centre with water from Maseno water supply. The DC's of both Luanda which was in North Kavirondo (Namely Kakamega District) and his counterpart from Yala (Central Kavirondo, Kisumu District) were requested to estimate the potential demand of these two centres. The information was to include⁸⁹²:

- Total population in races.
- Actual number of Individual connections that will be required immediately.
- Potential growth.

Not much action was taken thereafter, until 1954 when, on his way to Uganda, the Member for the Legislative Council, Kenya, Mr. Bachulal Gathani met with the Indian residents at Luanda and the issue of water was forcefully brought to his notice. In his letter, after the meeting, copied to the DC Kisumu and Kakamega, Secretary Indian Association and to the Member for the Legislative Council Western area Mr. J.S. Patel he expressed strongly the need to provide for water to Luanda, according to his letter, the Indians were paying KES 4 per day for water⁸⁹³.

Again it can clearly be seen that the Mr. Bachulal was only fighting for the interest of the Indian population in the trading centre.

The Survey team for Luanda Maseno Pipeline was put in from 27th January 1955. The cost of the system was to be 8,353 pounds.

Description of the system: The water was to be drawn from an existing 4 inch rising main to Maseno at the top of a ridge feeding 45.5m³ reservoir at the point on a ball valve, the quantity passing being measured by a metre. The water was then to gravitate to a 22.7m³ tank on a 12 feet tower situated on the main Maseno-Luanda road at Ebusagami CMS School, the main running along the top of the ridge and supplying any rural consumers end route. The School and any near consumers were to be fed directly from the tank, which was to be metered inlet and outlet. The

892 Colony and Protectorate of Kenya (1949 – 1964). Maseno Water Supply – Extension to Luanda. Kenya National Archives, Ref. No. DC/KMG/2/26/36, Nairobi, Kenya.

893 Colony and Protectorate of Kenya (1949 – 1964). Maseno Water Supply – Extension to Luanda. Kenya National Archives, Ref. No. DC/KMG/2/26/36, Nairobi, Kenya.

gravitational main was then to run within the road reserve to the Luanda Market where it would feed a 91m³ reservoir. The rural consumers would be supplied from that line. From the trading centre a reticulation was envisaged to run to the lower market, trading centre, and railway station.

All reservoirs were fed on ball valve and so were self-closing. A full system of metering was designed to ensure clear figures of the actual consumption by the rural consumers. Additions to the purification works consisted of a filters, stand-by plant and additional staff quarters⁸⁹⁴.

Initially it was anticipated that the consumption for Luanda would not exceed 22.7 m³ a day, however a system to provide 114 m³ per day was put in place which gave ample room for expansion before full capacity of the hydrostats (227 m³ per day) could be reached⁸⁹⁵.

Mugitiri Water Project: The Mugitiri water project was initially started by the Ministry of water Development and a feasibility report was prepared in October 1977. The scheme was to cover the whole of Kipipiri Division of Nyandarua District. After the feasibility report was prepared the D.D.C. decided to carry out the construction on a self-help basis and a phase 1 of the project was started in 1978 covering approximately 206km² with 4038 paid up members According to the design the ultimate water demand for the whole project was 3813 m³/day but the design had been based on 648 m³/day and was said to be enough for all the people using individual connections and livestock⁸⁹⁶.

The intake was constructed on Mahisimiti stream, which was a tributary of Wanjohi River and the water at this point had good quality. The intake consisted of an inlet channel 10 m long and a simple triangular sedimentation basin. A gravity main of medium grade and uPVC was under construction and was expected to deliver water to 90 m³ tank approximately 9 km away. From the tank the water will be gravitated to consumers through uPVC and G.S where necessary. The design of the distribution system has not been carried out⁸⁹⁷.

Malewa Water Supply: Malewa water project had Malewa cooperative society as its undertaker and the intake was a borehole as located in Miharati rural centre

894 Colony and Protectorate of Kenya (1949 – 1964). Maseno Water Supply – Extension to Luanda. Kenya National Archives, Ref. No. DC/KMG/2/26/36, Nairobi, Kenya.

895 Colony and Protectorate of Kenya (1949 – 1964). Maseno Water Supply – Extension to Luanda. Kenya National Archives, Ref. No. DC/KMG/2/26/36, Nairobi, Kenya.

896 Wanjohi Consulting Engineers (1979) Kipipiri Water Supply Project, Ministry of Water Development, Republic of Kenya, Nairobi.

897 Wanjohi Consulting Engineers (1979) Kipipiri Water Supply Project, Ministry of Water Development, Republic of Kenya, Nairobi.

near the D.Os office in Kipipiri division of Nyandarua district. The borehole was drilled in 1953 and test pumped to give a yield of 13638l/hr. A lister engine of 30 HP and generator were used to drive a submersible pump which used to pump water to a 45 m³ masonry tank approximately 50m away. The tank was in good condition and was roofed with corrugated iron sheet. The supply used to serve the centre and the surrounding homes with untreated underground water. There were few communal water points, which used to serve the people who didn't have individual connections⁸⁹⁸.

Manunga Water Supply: This water supply was located a few kilometres north of Miharati rural centre in Kipipiri division of Nyandarua district. It was a self-help water project and its intake was at Manunga stream. The water was of good quality and flowed from Kipipiri hill forest in a westerly direction towards Malewa River. The intake had a small intake weir and two gravity mains had been connected to the weir to serve the Manunga mission and the Manunga water supply project. The tank was constructed of masonry wall, roofed with corrugated iron sheeting and had a capacity of 45 m³. Distribution was by gravity through pipes of varying diameters and materials. The distribution system composed of uPVC and steel. The approximate total length of the main distribution mains was 10km. There were no air valves or washouts provided within the system.

It was estimated that this scheme served approximately 1500 people and their livestock and did so satisfactory when the river was flowing full and almost disappeared during the dry seasons. The dispensary, police and the administration office get water from this scheme⁸⁹⁹.

Wanjohi Water Supply: Wanjohi water supply was a self-help water project with approximately 300 members. The intake for this water supply project was located at Wanjohi River within Wanjohi market centre in Kipipiri division of Nyandarua district. A 25HP pump was used to pump water to a 4.5m³ storage tank at the health centre and to a 90m³ masonry tank approximately 1km. The diameter of the GI steel pumping main from the intake to the 90 m³ tank was 50mm with a small portion being 38mm diameter. A mixed steel and uPVC of 25mm diameter pumping main was used to deliver water to the Wanjohi Health centre elevated storage⁹⁰⁰.

898 Wanjohi Consulting Engineers (1979) Kipipiri Water Supply Project, Ministry of Water Development, Republic of Kenya, Nairobi.

899 Wanjohi Consulting Engineers (1979) Kipipiri Water Supply Project, Ministry of Water Development, Republic of Kenya, Nairobi.

900 Wanjohi Consulting Engineers (1979) Kipipiri Water Supply Project, Ministry of Water Development, Republic of Kenya, Nairobi.

Buguta/Makwasinyi Water Project: This project was located in Kasigau Location in Taita/Taveta district lying on the extensive Nyika plateau. Most of the project area was made up of poor alluvial deep sandy soils. The area was semi-arid having an annual rainfall of about 480-680mm and high temperatures averaging at 24.9 degrees centigrade. The only surface water available was located at the top of the Kasigau hills in small perennial springs that only travelled a short distance downstream before fading away. The 1991 population of the area was estimated at 10000 people. The Taita, Kamba and Duruma ethnic groups comprised the main inhabiting populations. Most of the population being low income families, relied on subsistence level cultivation and livestock farming as a source of income. Some people also engaged in small-scale business enterprises such as shops, maize mills hides and skins carpentry etc.⁹⁰¹.

There was no permanent source of surface water in the project area. Studies which included sinking of two exploratory boreholes were unsuccessful. Because of this, the average resident in the project area was forced to walk an average of 6 to 20 km a day to fetch water from the Kasigau hills. Livestock also trekked similar distances⁹⁰².

In 1984, the Buguta community formed the Taita integrated Rural community water project (TIRCOWAP) funded by the African Development Fund. Under this scheme, two boreholes were sunk at the Makumbusho area. This project was not a success. However, when KWAHO came in they organized a community workshop in the area involving some 52 participants in project definition, planning and detailing, a community water project, a self-help group was registered in January 1989. The community with the assistance of the MoWD and KWAHO personnel planned and designed the Buguta/Makwasinyi water project and opened an account. The community mobilized their resources: They paid membership fees; share capital; local expertise; and a series of Harambee fund raising drives were conducted⁹⁰³.

Through KWAHO, Water Aid (London) pledged support to the project to the tune of £ 136,000 to supplement the community's efforts. As a result, in March 1989, construction work commenced. Various agencies were involved with the community in executing the Buguta/Makwasinyi project among them KWAHO

901 Mwangola M. and Golicha H. K. (1991). Infrastructure, Environment, Water and People; Proceedings of the 17th WEDC Conference, United Nations Centre for Human Settlements (Habitat) Nairobi, Kenya, edited by John Pickford.

902 Mwangola M. and Golicha H. K. (1991). Infrastructure, Environment, Water and People; Proceedings of the 17th WEDC Conference, United Nations Centre for Human Settlements (Habitat) Nairobi, Kenya, edited by John Pickford.

903 Japan International Cooperation Agency (1992). The Study on National Water Master Plan. Sectoral Report (D). Domestic and industrial Water Supply. Ministry of Water development. Kenya.

and the ministries of Health, Water development and Culture and Social services as well as the local administration⁹⁰⁴.

Munyu Self-Help Water Supply Project: The project area was situated approximately 11 km east of Thika town and included parts of three sub locations of Juja location these being Munyu, Gatuananga and Ndarugu. The total area supplied by the scheme was 36 km². The population of the area based on estimates of 1999 was 21500 people. The scheme was being undertaken for the water association of Munyu, Gatuananga and Ndarugu with support from the GoK. Being a self-help water project it was intended that certain sections of the construction are undertaken by the local labour. The works comprised an intake from Thika River, a raw water pump house, treatment works with treated water storage and pump house, pumping main, elevated storage tanks, gravity distribution network and all the necessary communal water points, kiosks etc. The scheme was to supply 842 m³/day with extensions envisaged to achieve 1170m³/day by 1999⁹⁰⁵.

Mutitu Rural Water Supply: Mutitu was a regional centre in Kitui district. The main gazetted water scheme had its source in the Ngulini Mountain where there was a small catchment with pipelines leading out to 176 individual connections. The scheme served an area of about 60km², including Mutitu centre and institutions as well as Mui location. Along the pipeline going to Mui, there was another line joining with it from a borehole at Ikoo. This borehole was built by the MoWD in 1979 and it produced 7m³/hr. A self-help group was at the time trying to extend the network to reach cattle dip that was constructed in 1975 by the same group⁹⁰⁶.

Norosura Rural water scheme: Norosura was in the south of Narok town on the plain before Loita Hills. People were mainly Maasai pastoralists, with some irrigated cultivation going on using water from Norosura River or Kanunga River. The Norosura centre got water from a scheme which was built by UNICEF and which ran by a self-help group. The group's leader had difficulty collecting money from users leading to intermittent production⁹⁰⁷.

904 Mwangola M. and Golicha H. K (1991). Infrastructure, Environment, Water and People; Proceedings of the 17th WEDC Conference, United Nations Centre for Human Settlements (Habitat) Nairobi, Kenya, edited by John Pickford.

905 Ministry of Water Resources (1999). Community Water Supply Management Project; Environmental Impact Assessment Report on Onanan-Funyula Community Water Supply Project in Funyula Division, Busia District.

906 Ministry of Water Development (1983). Water Use Study; Draft Report, Nairobi, Kenya.

907 Ministry of Water Development (1983). Water Use Study; Draft Report, Nairobi, Kenya.

Log logo Rural Water Supply Scheme: This place in Marsabit District was created through the establishment of water schemes during the colonial days. The water scheme had individual connections, communal water point and cattle troughs from a borehole. Water for this source was a silted dam. As of 1983 the people were organizing themselves on a self-help basis as the Government no longer provided the necessary fuel⁹⁰⁸.

Inoi Rural Water Supply: This was a gravity scheme constructed during 1972/3 financial year. It covered an area approximately 80 kilometre square. It had two intakes; Mukengeria and Rundu Rivers and water flowed by gravity through UPVC pipes to storage tanks. When evaluated in 1984, the whole scheme needed augmentation due to faulty installations such as air valves, master metres etc. These problems arose from daily increase in water demand. Despite the usual minor problems, desilting of the intakes, line patrolling and replacement of the screens were strictly adhered to throughout 1984⁹⁰⁹.

Kabare water supply: Kabare rural water supply covered an approximate area of 74-kilometre square with a production of about 1560 metres cubic per day. The supply was completed in 1960/61 and was taken over by the government in 1973 for proper operation and rehabilitation. Before 1973, it was under the authority of Kirinyaga County council. In 1984, water shortage was experienced in some parts. Plans for rehabilitation started in the same year. Only few problems were experienced such as unlimited overflow of water in storage tanks due to lack of proper ball valves which proved non-operational despite installation of new ones. Table 3.47 illustrates operational gazetted water supply in Kabare water supply⁹¹⁰.

On account of non-payment of revenue for three months, Kabare water supply was turned off and later it was reinstated; income came in for a short period and then stopped again. It was practically impossible on rural pipelines to cut off individual consumers who did not pay, Usually cut-offs meant closing down a whole section of a scheme which included people who had already paid. Again the only practical course appeared to be a general levy⁹¹¹.

908 Ministry of Water Development (1983). Water Use Study; Draft Report, Nairobi, Kenya.

909 Ministry of Water Development 1984). Kirinyaga District. Kenya National Archives, X5/2/5. 1984.

910 Ministry of Water Development 1984). Kirinyaga District. Kenya National Archives, X5/2/5. 1984.

911 Director, Water Development Department (1965). Rural Water Policy. Water Development Department. Nairobi.

Table 3.47: Information on some of the operational gazetted water projects

Name of the water supply	Number of Individual Consumers		Average production per month (m ³)	Expenditure during the year (KES)	Revenue for the year (KES)
	1983	1984			
Kerugoya	778	835	25260	185819.00	637493.00
Wanguru	118	137	2174	121823.50	56363.00
Kianyaga	115	161	15224	155862.00	114470.00
Kabare	1128	1241	47480	194815.90	275238.00
Inoi	2201	2461	102480	170695.55	635490.00
Ngariama	712	1012	-	97435.70	158691.50
Total	5054	5747	167358	726451.65	1867745.50

Ndia water supply: Construction of this project phase one started towards the end of 1980. It covered an estimated area of 489-kilometre square covering Ndia division and most of Mutithi location in Mwea division. It was initially designed to serve 200,000 people with facilities for extension to capacity of 240,000. It was expected to produce 18,000 cubic metres per day of treated water by the year 2000. The first phase was almost completed by the year 1984 by Zakhem international construction ltd. Phase 2 had started in the same year (1984) covering some 84 square kilometres. The work involved pipe laying and water Kiosks. It was awarded to Karsam Ramji Construction co. Phase 3 was awarded to Broadways (k) Ltd⁹¹².

Ngariama Rural Water Supply: It was started in 1978 covering some 84 kilometre square. It was undertaken in phases and by December 1984 two intakes, two storage tanks of 45 cubic metres capacity and nine BPTs had been completed. In addition, approximately 14.8 kilometres of pipeline had been laid; four double grade 9 houses, three offices and a store were already constructed. Kanjuu self-help water project was started in 1984 and the connection to join the Ngariama rural supply was started. Generally, the project was well maintained and consumers were served with water despite minor problems, which were supervised by the district water office⁹¹³.

Kiangombe water supplies: The project is situated in Kabare location in Gichugu division. The project was started in 1967 covering an estimated area of about 8 kilometre square serving about 2,500 people. Majority of the rehabilitation work was carried out in 1984, these included improvement of the intake, roofing of the storage tank and enlargement of the main and various distribution lines⁹¹⁴.

912 Ministry of Water Development 1984). Kirinyaga District. Kenya National Archives, X5/2/5. 1984.

913 Ministry of Water Development 1984). Kirinyaga District. Kenya National Archives, X5/2/5. 1984.

914 Ministry of Water Development 1984). Kirinyaga District. Kenya National Archives, X5/2/5. 1984.

Kiangwenyi water supply: Kiangwenyi women water project is adjacent to Kiangombe project. It is a few kilometres east of Mt. Kenya forest. Phase one of the project was operational by 1984 although required rehabilitation. The project had not been funded by D.D.C. though earlier on it had received some aid from CARE Kenya in form of pipes, which were laid with the required technical assistance from the ministry of water development, Kirinyaga office⁹¹⁵.

Muratiri water project: The project got its raw water from Mukengeria River. A self-help group wholly funded it. The DC's office assisted the beneficiaries purchase the necessary materials such as pipes and fittings in 1984. The project was recommended for assistance from DDC in 1984.

Teithia Teithia Water Project: The project was initiated in 1966 by a group of 82 members. It is situated in Mwea division. Raw water was abstracted through a furrow from Kyie River. In 1984, phase two was completed. Operation and maintenance of the project was carried out perfectly by the beneficiaries with assistance from the ministry's office.

Mutungara water Project: Was initiated by local people in 1976. It covered Kirimara sub location in Mwea division. Raw water was pumped from Nyamindi River to four storage tanks of 27.3 capacity. By 1984, it had been connected to Ngariama water supply. Installation of individual connections started during the year and it was hoped that the remaining work would be completed by 1985.

Nyagithuci Water Supply: This was a self-help water project. The intake construction was completed in 1984. The project was proposed and recommended for funding under Rural Development Fund Programme.

Water Supply to Kerugoya: An inspection carried out by the Deputy Director of Medical Services in 1929 revealed that the only water supply to Kerugoya hospital was through a furrow. Water for the hospital was fetched by large number of porters who were very expensive to maintain. Rainwater tanks were needed for preservation and storage. A proper water supply to the hospital was proposed in 1930, but could take some considerable time before the system was installed. The Director of Public Works proposed that a piped water supply be provided for Kerugoya Hospital, and

915 Ministry of Water Development 1984). Kirinyaga District. Kenya National Archives, X5/2/5. 1984.

the cost of a Hydraulic Ram Scheme to supply the station generally, as well as the Hospital was estimated to be 550 pounds however, there were no funds⁹¹⁶.

The existing water supply by furrow consisted of an approximate 10 kilometre long furrow and passed through the hospital reserve. The furrow was originally constructed by the Administration Officers at Kerugoya for the use of Kerugoya station. The furrow occasionally flowed through the banks due to lack of maintenance. The water was quite good and clean but it became polluted during rainy seasons⁹¹⁷.

By 1932, seven hospital porters took a lot of time daily getting water from the valley near-by and from the adjacent furrow. This made it difficult to keep the compound clean and tidy, maintain the temporary buildings and to arrange for the whitewashing of the buildings, or for other routine works. The following report was also submitted the same year⁹¹⁸.

The possible ways of improving the water supply at Kerugoya Hospital included:

- Additional rainwater tanks. In 1931, a proposal was made to install four 500 gallon tanks with the erection of the necessary stands and connections, at a cost of 40 pounds. However, the funds were not available.
- Construction of sand filter, with a sedimentation tank, in connection with the furrow.

Installation of a pump worked with hand or windmill, with necessary piping and storage tank in connection with the permanent spring which was close to the hospital and a large rain-water reservoir⁹¹⁹.

It was further proposed that if funds would not be available the following year for the construction of a water supply, a well be in the hospital compound or a sand filter be constructed⁹²⁰.

By 1934, according to the Medical Officer, the quantity of spring water used daily for drinking, cooking and medical purposes was 160 gallons, an average of 4 gallons for 40 patients. An average of 1 gallon per patient was also used at the laundry that is 200 gallons. This amount was below the requirements for the laundry,

916 For A G Director of Medical and Sanitary Services (1929). Native Hospital, Kerugoya. Kenya National Archives. XB/4/2 16th October, 1929.

917 Assistant Engineer I/C P W D Nyeri (1929). Water Supply-Kerugoya Native Hospital. Kenya National Archives. XB/4/2 Ref 1780/24/1/8 30th October, 1929.

918 Assistant Engineer I/C P W D Nyeri (1932). Water Supply-Kerugoya Hospital. Kenya National Archives. XB/4/2 20th April 1932.

919 Assistant Engineer I/C P W D Nyeri (1932). Water Supply-Kerugoya Hospital. Kenya National Archives. XB/4/2 20th April, 1932.

920 Assistant Engineer I/C P W D Nyeri (1932). Water Supply-Kerugoya Hospital. Kenya National Archives. XB/4/2 20th April, 1932.

ablution, baths, washing of utensils, furniture and floor as the requirements was 10 gallons per person and also an average of 15 gallons was not excessive⁹²¹.

In 1935, the rain water tanks in the hospital were inadequate – they held 100 gallons and carrying water took up practically all the time of the five porters. It was proposed that the tanks be replaced with bigger 1,000 gallon tanks⁹²².

The Senior Assistant Engineer proposed that the proposed water supply for the hospital should include staff quarters, sisters' quarters and the dukas. He also suggested that the rates for a piped water supply would probably be as in other small towns⁹²³. It was however noted that the Medical Officer, nursing sisters and bazaar were not in favour of paying the comparatively high charges from the proposed ram supply, thus the site of service tank needed only to be sufficient to supply the hospital only⁹²⁴.

By 1935 construction of the hospital water supply had been approved and although the hydraulic ram and pipe line were of sufficient capacity to supply the Doctor's and Nurses' house it was not possible to connect them by then⁹²⁵. The delivery pipe from the ram was to be $\frac{3}{4}$ in galvanised Iron Water quality and was to pass direct from the ram to a point just in front of the Hospital office and hence to the tank⁹²⁶.

A 1500 gallon capacity tank was also proposed which was to be 6'0" deep x 7'6" internal diameter. The tank was to be constructed half in the ground and the excavated material used to embark the walls where they were above the normal ground level. The roof was to consist of 4" reinforced concrete slab resting freely on walls⁹²⁷.

The hydraulic ram was to be imported and it was anticipated that it would take six weeks before it arrived in Nairobi. Immediately it arrived it was to be despatched to Kerugoya together with the makers' directions of fixing, piping and fittings⁹²⁸.

In 1939, the ram had been install and provided water for the hospital, however, there was a shortage due to the failure of the hydraulic ram caused by poor silting,

921 Medical Officer (1934). Water supply-Kerugoya Hospital. Kenya National Archives. XB/4/2 6' July 1934.

922 For Director of Medical Services (1935). Kerugoya Hospital. Kenya National Archives. XB/4/2 Ref 40/1380/5 28th February, 1935.

923 Senior Assistant Engineer, P W D Nyeri (1935). Kerugoya Hospital-Proposed Water Supply. Kenya National Archives. XB/4/2 Ref 851/7/2/3/1 31st May, 1935.

924 Senior Assistant Engineer, P W D Nyeri (1935). Kerugoya Hospital-Water Supply. Kenya National Archives. XB/4/2 Ref 1079/7/2/3/1 20th June, 1935.

925 Director of public Works (1935). Kerugoya Hospital Water Supply. Kenya Nation Archives. XB/4/2 Ref D 938/117/2/1/9 9th July 1935.

926 Director of public Works (1935). Kerugoya Hospital Water Supply. Kenya Nation Archives. XB/4/2 Ref D 938/117/2/1/9 9th July 1935.

927 Director of public Works (1935). Kerugoya Hospital Water Supply. Kenya Nation Archives. XB/4/2 Ref D 938/117/2/1/9 9th July 1935.

928 Director of public Works (1935). Kerugoya Hospital Water Supply. Kenya Nation Archives. XB/4/2 Ref D 977/117/2/1/9 23rd July 1935.

and according to the Divisional Engineer the only everlasting remedy to this problem was to provide a large silt chamber⁹²⁹.

The same year the Director of Public works reported that the pumping unit at Kerugoya Hospital was a Blakes “B” type hydraulic ram which even under less arduous condition than those at Kerugoya needed to be renewed, returned and/or re-bored at intervals. He noted that installation of large silt chamber would obviate the necessity for this but could increase the interval before failure. Thus a stand by ram was needed in addition to the enlarged silt chamber⁹³⁰. Regarding the weaknesses of the Blakes B type ram were caused by leakage of air in the drive pipe and lack of sufficient air in the vessel⁹³¹.

In 1946 Medical Officer reported that Dried Vegetable Project Water Works was the sole supplier of water to the hospital and European housing at Kerugoya. It was a fairly complicated system of settlement tanks and it was run by two Africans⁹³². The big question was who would supervise the water works as no decision had been made up, and it was clear that the Kerugoya factory branch was to close down on 31st march 1946.

In the meantime, the hospital could run the works on the basis of 60,000 gallons per week. That is, they would run the water works for one day per week to fill the storage tanks. One man was needed for this work at a salary of KES 50 per month⁹³³.

This alternative was considered more viable than the Public Works taking over the works and then charging a rate and also the man who would be employed could as well do some other works when not working on the settlement tanks⁹³⁴. It was also reported that before the construction of the Dried Vegetable Factory at Kerugoya the hospital obtained its water supply by means of A-type ram. This was never satisfactory thus; it was removed after the hospital was connected to the factory water supply.

The factory closed down in 1946 and the question of operating the water supply for the use of the hospital was discussed between Divisional engineer and Officer in Charge, Dried Vegetable Factory. After the discussion it was agreed that the factory staff would operate the water supply for some time, and it was hoped

929 Provincial Commissioner Central (1939). Kerugoya Hospital Water Supply. Kenya National Archives. XB/4/2 Ref D 712/117/2/1/9 6th July, 1939.

930 Tetley (SD) A.E (1939). Kerugoya Hospital-Water Supply. Kenya National Archives. XB/4/2 Ref D 712/117/2/1/9 6th July, 1939.

931 Arnot (SD) W D (1940) Blakes B Type Ram. Kenya National Archives. XB/4/2 2nd September, 1940.

932 Walker A.J (S g d) (1946). Water Supply-Kerugoya Hospital. Kenya National Archives. XB/4/2 Ref G E N 106/3/46 19th March, 1946.

933 Walker A.J (S g d) (1946). Water Supply-Kerugoya Hospital. Kenya National Archives. XB/4/2 Ref G E N 106/3/46 19th March, 1946.

934 Walker A.J (S g d) (1946)/ Water Supply-Kerugoya Hospital. Kenya National Archives. XB/4/2 Ref G E N 106/3/46 19th March, 1946.

that a decision regarding the future of the factory would also settle the question of the operating of the water supply⁹³⁵.

Highlights from the Rural Water Supply Development

Self-Help Water Schemes: One of the most original and significant phenomena of post-independent development activity was the Harambee or Self-Help movement. In the early years, the self-help movement emphasised on education and small development projects. To a greater extent after filling the education vacuum at primary and secondary level, there was a shift from concentration on small scale projects such as spring protection, boreholes and other minor works to large-scale major investments such as the proposed £1.6 million Kandara Water Scheme⁹³⁶.

In 1970 water development ranked equally with education as the type of projects given highest priority by the farmers and labourers at the rural areas. Some of the reasons why water development was prioritised by the local people included the following:

The education needs were mainly satisfied.

Water affected each and every member of an area, in a direct way unlike other projects such as roads.

With development, certain age-old practices become no longer necessary or acceptable and carrying water up steep slopes or over a long distance was one such activity.

There was also the demonstration effect in the 1950's and 1960's of the former ALDEV schemes and WHO/UNICEF environmental sanitation programme. These programmes resulted in water schemes in every district in Kenya. This probably helped create the widespread interest with the locals.

The agricultural development witnessed during this time resulted in an increase demand for water for new enterprises and activities, that is crop and livestock needs.

Women education, together with social and political activity had been strengthened, resulting in a shift in priority toward water development noting that throughout Kenya the main burden of water carrying was borne by the women.

The numerous self-help schemes were a symptom that the public was dissatisfied with the Government's ability to provide public schemes⁹³⁷.

935 Face H.H (1946). Water Supply- Kerugoya Hospital. Kenya National Archives. XB/4/2 Ref 659/7/2/3/1 28th March, 1946.

936 Agrarian Development Studies (1977). Impact and Economics of Community Water Supply. A Study of Rural Water Investment in Kenya Report No 6. Carruthers I.D.

937 Agrarian Development Studies (1977). Impact and Economics of Community Water Supply. A Study of Rural Water Investment in Kenya Report No 6. Carruthers I.D.

The self-help water improvement had become a common activity. In 1967, 460 water supplies were completed at a cost of £77,000 (78 piped supplies, 157 wells, 84 spring protection and 156 dams and catchments. This is according to Ministry of Planning Report, (1968). The only new thing was the scale of some of the projects. For example Kandara Water Scheme in Murang'a cost £1.6 million; Mathira division near Nyeri had a series of schemes under construction costing between £0.1 and £0.2 million each and other plans in other district for schemes of similar scale.

The major problems affecting self-help water projects include the risk of politically well supported schemes queue jumping the Government priorities, shortage of funds to complete over-ambitious schemes, inability and/or unwillingness to maintain schemes, or pay water rates and extortions of cash from unwilling or reluctant local resident. Some schemes were too large to be manageable and construction was too slow to satisfy the beneficiaries. Large projects generated large amounts of cash and there have been problems with administering and accounting for the collected money on some schemes.

Operation and maintenance of self-help schemes: After the construction of a scheme there were two alternatives for operation and maintenance procedures. The self-help association could continue to administer the scheme or it could be handed over to the Government. The latter course was recommended as the Water Department had the necessary expertise and experience, machines, and equipment to ensure economic service⁹³⁸.

Conclusion and recommendation on self-help water projects: However, laudable self-help activities were, they could not be used to distort National priorities, nor should the impatience of participators be permitted to result in a waste of their own scarce resources.

It was recommended that a greatly strengthened self-help technical service be provided by the Water Department but that large schemes (over £15,000) be discouraged and, if formulated, made the responsibility of the DDCs and through them the Central Government. Also self-help collections for large schemes and labour inputs should be taken into account in selection and allowed for in later revenue levies. The proposed District Water Teams should assume responsibility for operation and maintenance of all but the very smallest schemes.

Self-help contributions should be given greater priority in selection. Large self-help schemes (over KES 0.5 million) should be made the responsibility of the

⁹³⁸ Agrarian Development Studies (1977). Impact and Economics of Community Water Supply. A Study of Rural Water Investment in Kenya Report No 6. Carruthers I.D.

DDCs. The formulation of such a scheme by a self-help group should be used as a measure of local enthusiasm by DDCs in making their recommendations on scheme priorities. Such a procedure would ensure that self-help schemes were not used to usurp Government priorities and would be a good measure of the people's commitment to a project, a feature which has been lacking in some cases in the past.

It was recommended that resource allocation to self-help should be considerably increased, perhaps tripled in the next five years which should be used mainly for small schemes (of less than 150 families). In addition the consultant considered that there was a potentially increased role for the Government supplying a bulk main, then selling water to small groups of about 40 households as and when branch lines were constructed on a self-help basis.

Self-help projects could benefit a lot through improved services from machines, the scope for this could range from the increased use of aircraft for such activities as dam and tank siting and use of air photographs I design, to small equipment such as purchase of electronic calculating machines and improved telephone systems.

By improving working procedures and methods, as there were no management specialists who were working within the water department hence basic information such as time distribution, planning costs were not readily available. This meant that it was not possible to allocate staff to particular types of schemes. It also meant that when instances of inefficiency were detected there was little flexibility in procedures. For example, in 1970-71, it was established that 60 per cent of local purchase orders which generated considerable paper works with time consuming procedures such as obtaining quotations covered only 4 per cent of expenditures, thus raising the need to instigate changes in procedures.

Efficiency of professional staff could also be increased by more sub-professional support staff, the supply of which was relatively elastic. If support staff and services were improved it could probably help to decrease the high staff turnover rate. This was the most costly phenomena to the Department and was a characteristic of both Kenyan and expatriate staff.

In the early 1970's one of the major improvement in efficiency stemmed from the introduction of planning and design guidelines for both consultant and departmental use, as opposed to the to the situation in the 1960's when each engineer used his own personal design criteria.

Institutional Water Supplies

The ministry through the district office undertook to maintain certain institutional water supplies at the request of the departments concerned. Funds were normally provided by the department concerned to enable the ministry carry out the work

on urgency basis. No funds were allocated for the same in 1984 though the office assisted technically where possible. Most of the skilled labour on pumps and engines were done at Wamumu School when their pumping unit broke down. Minor problems were solved at Gathigiriri prison to ascertain that there was a flow of water at all the time.

On top of the ministerial, institutional and major self, help projects, technical advices were offered to the needy on irrigation schemes, or individual domestic water schemes. The general procedure of work consisted of field survey, actual surveying and route plans of all projects, and finally the analysis and preparation of bill of quantities⁹³⁹.

Public Standpipes in Rural Water Supplies: By 1983, the design manual for MoWD called for serving of most of the population resident within the area of supply through individual connections and Kiosks. The kiosks were operated by a private person authorized by MoWD. It was anticipated that persons without individual connections would purchase water from the kiosk. The MoWD established the tariffs payable for water purchased in bulk and water sold to the public.

The Kiosk System: The Kiosk system was introduced in 1977 in response to widespread belief within MoWD that the communal water points (CWPs) were not successful. The CWPs were originally perceived to serve a registered list of households who paid a fixed amount per month for the use of water to be drawn from the public standpipe. During the period, 1970-1977 collection of user fee became impossible and there was widespread vandalism and wastage of water. The district water officers observed that communal water points would never work. The holder of flat rate connection allowed the nearby households to draw as much as water as they wished for a fixed charge, a practice that was very wide spread⁹⁴⁰.

In 1983, anyone was permitted to apply to MoWD for permission to operate a Kiosk. The application was reviewed up to the to the provincial water officer level. The kiosk operator had to have a metered IC and was supposed to provide water during certain hours. The operator was also supposed to provide a kiosk structure to permit orderly sale of the water and to pay his bills according to regulations. The kiosk and connections were often built when water scheme was being built. The operator purchased in bulk at KES 1/25 per cubic metre, paid a monthly metre rental, and officially sold at a rate of KES 2/50 per cubic metre. Normally there

939 Ministry of Water Development 1984). Kirinyaga District. Kenya National Archives, X5/2/5. 1984.

940 Ministry of Water Development (1983). Water Use Study, Main Report 1983. Ministry of Water Development Nairobi Kenya

were no convenient facilities for bathing, doing laundry or watering livestock. The Kiosk was strictly for providing water for household use⁹⁴¹.

The idea underlying the distribution of kiosks was to administer the physical contribution of kiosks through issuing of licenses. The local monopoly positions thus granted are controlled by an administered price. The imposition of bureaucratic judgement was believed to permit a fairer distribution of water⁹⁴².

Basic Strategy of Rural Water Supply

By 1987, the estimate of rural population coverage by piped water supply, including communal water was 5-10 percent. This small percentage was achieved through more than 20 years efforts since the independence. This indicated that the government target of 100 percent coverage by 2000 for rural population could not be realized by the same methods of water supply schemes. It was generally recognized by the MoWD officials that the water supply service standard in the past was not appropriate. Alternately, attention was turned to groundwater development with the use of boreholes, wells, springs and particularly hand pumps⁹⁴³.

Community involvement: The most important problem associated with rural water supply was maintenance of facilities. Traditionally, women fetched domestic water from a stream or springs, free of charge. A water supply facility initiated and constructed by the government appeared to belong to the government, therefore people did not care much the facilities and considered water as a gift. This perspective was drastically changing and by 1987, there was a big gap between traditional way of water use and the existing rural water supply i.e. change from gift to a commodity. This led to evolution of a policy to involve people as much as possible, from the beginning of a project to make people responsible for maintenance costs, and to start construction only after people are able to cater for the maintenance cost.

Purification of Water on a Small Scale

The Division of Environmental Sanitation World Health Organisation in 1954 presented a report on the three methods for water purification used on an individual

941 Ministry of Water Development (1983). Water Use Study, Main Report 1983. Ministry of Water Development Nairobi Kenya.

942 Ministry of Water Development (1983). Water Use Study, Main Report 1983. Ministry of Water Development Nairobi Kenya.

943 Republic of Kenya (1987). The Study of Integrated Regional Development Master Plan for the Lake Basin Development Area- Final Report Vol. 5. Lake Basin Development Authority-Japan International Cooperation Agency.

or domestic scale. These were: Boiling, chemical disinfection and filtration, these methods could either be used individually or in combination⁹⁴⁴.

Boiling was a satisfactory method for destroying disease organisms in water, and it was equally effective whether the water was clear or cloudy, whether it was relatively pure or heavily contaminated with organic matter. This method destroyed all forms of disease organisms such as bacteria, spores, cysts or ova that were contained in water. In order to boil water a fuel was needed the fuel depended on the type of fire, stove and vessel used? Under normal conditions associated with boiling of drinking water, one kilogram of firewood was needed to boil one litre of water (two pounds per quart)⁹⁴⁵.

For the water to be safe for consumption, it was to be brought to a rolling boil. Sometimes the appearance of bubbles was confused with boiling as it was the appearance of mist or steam over water, but none of these was a sufficient sign that water had reached a boiling temperature. It was recommended that water should be boiled in the same container in which it was to be cooled and stored. This container was not supposed to be used for any other purpose. It was further reported that boiling altered the taste of water because it eliminated dissolved gases, particularly carbon dioxide⁹⁴⁶.

Chlorine was a useful disinfectant for drinking water, and it was effective against the bacteria commonly associated with water-borne diseases. It was reported that in the usual dose, chlorine was not effective against certain cysts and ova, nor organisms embedded in solid particles. Thus, sufficient chlorine was supposed to be added to satisfy the chlorine demand in addition to amount that was required for bactericidal action. Chlorine was easiest to apply in the form of a solution⁹⁴⁷.

Iodine was a first class disinfecting agent. Tincture of iodine could be used to disinfect water and generally, two drops of 2% tincture of iodine was sufficient for one litre (1 quart) of water. Where water was heavily polluted, the dose was supposed to be doubled as there was no harm in using such amounts of iodine, but the higher dosage would produce a medicinal taste⁹⁴⁸.

Potassium Permanganate was commonly known as “pinkie” and had been frequently used for disinfection of water. It was a powerful oxidizing agent and favoured

944 World Health Organization (1954). The Purification of Water on a Small Scale. Kenya National Archives. BY/35/15 15th. November 1954.

945 World Health Organization (1954). The Purification of Water on a Small Scale. Kenya National Archives. BY/35/15 15th. November 1954.

946 World Health Organization (1954). The Purification of Water on a Small Scale. Kenya National Archives. BY/35/15 15th. November, 1954.

947 World Health Organization (1954). The Purification of Water on a Small Scale. Kenya National Archives. BY/35/15 15th. November 1954.

948 World Health Organization (1954). The Purification of Water on a Small Scale. Kenya National Archives. BY/35/15 15th. November 1954.

due to its fast action in water containing organic components. The commonly used dosage was one part in 2,000 or 0.5 grams per litre. It was reported to possibly effective against the cholera germ, but was of little use against other disease organisms. Thus, it was not satisfactory and was not recommended for water disinfection⁹⁴⁹.

Filtration comprised use of two types of filters, the sand filter, which was relatively coarse, and the ceramic filter, which was of a finer texture which was commonly used in the treatment of household water supplies⁹⁵⁰.

Sand filter was supposed to be skillfully operated to be effective against bacteria. However, it removed cysts, ova and similar relative large organisms. For it to be more effective, water was supposed to be carefully treated first with alum. Some household filters contained charcoal, which had no purifying effect, but its only function was to absorb certain taste-producing compounds and make the water sweeter, but even this effect was lost unless the charcoal was frequently renewed. It was reported that some sand filters often got partially clogged with organic matters, and under certain conditions, this resulted in bacteria growth in the filter. Moreover, in some cases it was reported that filtered water had higher bacteria content than the unfiltered water. These filters were not recommended unless the water was to be boiled or disinfected after filtration⁹⁵¹.

Ceramic filters were of several types. They included pressure filters, non-pressure filters and filter pumps, and there was a wide range of ceramic media having different pore sizes. The most important thing of all these filters was the filter candle and the method of getting water through the candle was just a matter of convenience. It was suggested that only clean water should be used with ceramic filters as cloudy or turbid water clogged the candle very quickly⁹⁵².

Coarse-grained filters candles were useful in removing suspended matters, thus they were partially effective in removing the smaller disease organisms, and consequently water was to be chlorinated or otherwise disinfected after passage through a coarse-grained or industrial type filter. Fine-grained porcelain filters were the most effective as they removed all disease organisms found in drinking water, and it was quite safe to use water after passing through such a filter without further treatment.

949 World Health Organization (1954). The Purification of Water on a Small Scale. Kenya National Archives. BY/35/15 15th. November 1954.

950 World Health Organization (1954). The Purification of Water on a Small Scale. Kenya National Archives. BY/35/15 15th. November 1954.

951 World Health Organization (1954). The Purification of Water on a Small Scale. Kenya National Archives. BY/35/15 15th. November 1954.

952 World Health Organization (1954). The Purification of Water on a Small Scale. Kenya National Archives. BY/35/15 15th. November 1954.

These filters must be cleaned and boiled at regular interval that is at least once per week⁹⁵³.

Kieselguhr or infusorial earth filters had a higher flow capacity than porcelain filters, and except for the heavily polluted water, they were safe to use without giving the water further treatment. These filters were supposed to be cleaned more frequently at an interval of no longer than four or five days. There was a special type of Kieselguhr candle known as “Katadyn”. Its surface was coated with a silver catalyst in such a way that the porosity was not impaired, but the bacteria encountering the surface were killed by oligo dynamic action. It only needed cleaning when it clogged⁹⁵⁴.

Water storage: It was reported that no matter how much care was used in producing safe water, all the work could be nullified if the water was contaminated after treatment. The most important thing was only to keep the water clean. The principles for this were simple that is, water was to be stored in clean vessels, do not dip anything into water and vessels were to be kept covered to prevent the entrance of insects, dust or other foreign substances. Cleanliness of the vessels involved periodic emptying, washing, and rinsing with scalding water, or with heavily chlorinated water to prevent accumulation of slime growths. Nothing was supposed to be dipped in water⁹⁵⁵.

Wherever possible it was advisable to use small-mouthed vessels with a neck small enough to prevent entry of dipper, cup or hand, and wherever a large vessel was used arrangements were to be made for easy pouring either by tipping or by rolling the vessel⁹⁵⁶.

Water-quality control and treatment: In 1955, it was reported that provision had been made in the proposed new laboratory for a separate water and sewerage laboratories and an additional analyst had been recruited to work specifically on water. It was contemplated that when re-housed (it was hope that the department was to move into its new, properly equipped laboratory the following year) it would undertake development work in connection with sewerage and effluents. This work was previously covered by the chemical section⁹⁵⁷. In 1955; the Director of Medical Services issued the following report concerning water purification in Kenya⁹⁵⁸.

953 World Health Organization (1954). The Purification of Water on a Small Scale. Kenya National Archives. BY/35/15 15th November 1954.

954 World Health Organization (1954). The Purification of Water on a Small Scale. Kenya National Archives. BY/35/15 15th November 1954.

955 World Health Organization (1954). The Purification of Water on a Small Scale. Kenya National Archives. BY/35/15 15th November 1954.

956 World Health Organization (1954). The Purification of Water on a Small Scale. Kenya National Archives. BY/35/15 15th November 1954.

957 Kirby N (1955). Water-Quality Control and Treatment. Kenya National Archives. BY/35/15. Ref A/1/59 5th June 1959.

958 For Director of Medical Services (1955). The Purification of Water on a Small Scale. Kenya National Archives. BY/35/15 5th December, 1955.

It was reported that no routine Programme of watershed protection on large scale was so far carried out. Each scheme was given individual attention. Some were protected through fencing, others through controlled grazing and in some cases by drain construction for diverting streams known to be of a continuous pollution⁹⁵⁹.

In Kenya, it was reported that it was a standard practice to reduce all water for public supplies to zero turbidity. However, there was an exception to this practice, where the raw water was completely clear and this was only in case the water source was a well or borehole. The methods adopted for this purpose varied in details depending upon circumstances, but all methods normally followed the pattern of flocculation by the addition of alumina ferric and mixing, retention and settlement of suspended solids in various types of sedimentation tanks. Thereafter, filtration was done through graded sand beds was done⁹⁶⁰.

The main problem in Kenya was the removal of toxic fluorides, which occurred throughout the colony in the numerous volcanic aquifers. In the past years it was possible to evade the problem by seeking alternative sources for public supplies where concentration was unduly high. However, where there was no alternative water source fluoride concentration up to 5 ppm was permitted in public supplies. In such cases, consumers were advised to collect rainwater for drinking and cooking purposes, particularly where young children were concerned⁹⁶¹.

It was reported that since 1952, the Public Work Department had been carrying out research into economical methods for reducing fluorides and addition of Magnesium Oxide and Ammonium Chloride was a valid option⁹⁶².

In some supplies, treatment was also required for the removal of iron and for softening purposes. In this case, iron was removed by oxidation through aeration, and subsequent settlement. Whereas softening was generally effected by the Lime-Soda process, in which the chemicals causing hardness were converted to insoluble Calcium Carbonate, which was precipitated and drawn off⁹⁶³.

Disinfection to eliminate pathogenic organisms: As in Kenya, facilities for bacteriological analysis were few and far between, it was a standard practice to disinfect all public water supplies. To facilitate this, chlorine either in gaseous form or as a

959 For Director of Medical Services (1955). The Purification of Water on a Small Scale. Kenya National Archives. BY/35/15 5th December, 1955.

960 For Director of Medical Services (1955). The Purification of Water on a Small Scale. Kenya National Archives. BY/35/15 5th December, 1955.

961 For Director of Medical Services (1955). The Purification of Water on a Small Scale. Kenya National Archives. BY/35/15 5th December, 1955.

962 For Director of Medical Services (1955). The Purification of Water on a Small Scale. Kenya National Archives. BY/35/15 5th December, 1955.

963 For Director of Medical Services (1955). The Purification of Water on a Small Scale. Kenya National Archives. BY/35/15 5th December, 1955.

solution of lime, was added to the fully treated water in such a quantities as would result in a free chlorine residual of 0.2 ppm after 30 minutes contact⁹⁶⁴.

Standard of Water Quality: It was reported that there was no formal standard of water quality, which were laid down in Kenya, and generally, the equivalent standards applicable in the United Kingdom were adhered to⁹⁶⁵.

In 1959, it was reported that the Ministry had received from time to time complaints from private individuals regarding quality and quantity of water supplied by private water undertakings. Under section 145 of the water ordinance, the Minister for Agriculture had powers to order an investigation into the complaints and, on the basis of the advice received, could order water undertaker to take the necessary remedy recommended⁹⁶⁶.

It was further reported that as far as the complaints of water quantity were concerned, the matter was within the sphere of hydrology. Nevertheless, in case of quality, it was necessary to obtain the advice of medical officer. It was suggested that any complaints about quality of water was to be referred in the first instance to the Medical Officer of Health, and the action under section 145 of water Ordinance, was only to be taken by the Hydraulic Branch of this Ministry when so requested by the Public Health Authority⁹⁶⁷.

In 1959, the Local Authorities who were also Public Health Authorities gave the following report concerning the question of complaints regarding quality of water supplies by private water undertaking⁹⁶⁸. Tables 3.48, 3.49 and 3.50 are summaries of the replies received⁹⁶⁹.

964 For Director of Medical Services (1955). The Purification of Water on a Small Scale. Kenya National Archives. BY/35/15 5th December, 1955.

965 For Director of Medical Services (1955). The Purification of Water on a Small Scale. Kenya National Archives. BY/35/15 5th December, 1955.

966 For Permanent Secretary to the Ministry (1959). Complaints Regarding Quality of Water Supplied by Private Water Undertakers. Kenya National Archives. BY/35/15 Ref WAT 36/33/27, 14th April, 1959.

967 For Permanent Secretary to the Ministry (1959). Complaints Regarding Quality of Water Supplied by Private Water Undertakers. Kenya National Archives. BY/35/15 Ref WAT 36/33/27, 14th April, 1959.

968 McCartney J.S (1959), Complaints Regarding Quality of Water Supplies by Private Water Undertakings. Kenya National Archives. BY/35/15, 10th August, 1959.

969 McCartney J.S (1959), Complaints Regarding Quality of Water Supplies by Private Water Undertakings. Kenya National Archives. BY/35/15, 10th August, 1959.

Table 3.48: Quality of water supplies by private water undertakers given by Municipalities in 1959

Municipality	Remarks given
Nairobi "A"	The municipality was the sole water undertaker and supplier within the city.
Kisumu "A"	There was no private undertaker. It was agreed that any complain against wa-ter quality should be reported to them for advice before any action was taken.
Mombasa "A"	It was agreed that complaints against the quality of water supplied by private undertakers be referred to them for advice before any action was taken.
Eldoret "A"	Agreement was as in the case for Mombasa
Nakuru "A"	Agreement was as in the case for Mombasa
Kitale "A"	The water supply for Kitale was still under Government control.

Table 3.49: Quality of water supplies by private water undertakers given by African District Council in 1959

African Council	Remarks given
Machakos "A"	It was agreed that complaints against quality of water by private un-der-takers should be referred to them for advice before any action was taken.
Kajiado "A"	Agreement as in Machakos above
Meru "B"	The African District Council did not have the required facilities. Thus, it was suggested that complaints should be addressed to the Medical Officer of Health.
Taita/Taveta "B"	Had no staff to deal with the matter.
Narok "B"	Had no staff to deal with the matter.
Baringo "B"	There were no private undertakers in the area.
Tana River "A"	It was agreed that complaints against quality of water by private un-der-takers should be referred to them for advice before any action was taken.
Kitui "B"	There were no private undertakers in the area.
Kilifi "A"	There were no private undertakers in the area. The Health Inspector said that he would be able to use the facilities at Mombasa.
Central Nyanza "A"	It was agreed that complaints against quality of water by private un-der-takers should be referred to them for advice before any action was taken.
Kwale "A"	It was agreed that complaints against quality of water by private un-der-takers should be referred to them for advice before any action was taken.
North Nyanza "B"	Had no staff to deal with the matter.
Embu "A"	It was agreed that complaints against quality of water by private un-der-takers should be referred to them for advice before any action was taken.

Nyeri "A"	It was agreed that complaints against quality of water by private undertakers should be referred to them for advice before any action was taken.
West Suk "B"	The circular for improvements was not applicable.
Mukogodo "B"	There was neither private water undertaker nor the required staff to carry the test.
Nandi "B"	There was neither private water undertaker nor the required staff to carry the test.
South Nyanza "A"	It was agreed that complaints against quality of water by private undertakers should be referred to them for advice before any action was taken.

Table 3.50: Quality of water supplies by private water undertakers given by County Councils in 1959'

County Council	Remarks given
Nakuru "A"	It was agreed that complaints against quality of water by private undertakers should be referred to them for advice before any action was taken.
Naivasha "A"	They agreed in principle, the sample should be sent to the Government Analyst.
Nairobi "A"	It was agreed that complaints against quality of water by private undertakers should be referred to them for advice before any action was taken.

Explanation

In those marked "A" the complaints against the quality of water would be referred to them for advice before action was taken. Moreover, if they had no facilities for carrying out tests the Local Health Inspector was to be asked for assistance.

In those marked "B", the prevailing procedure would continue for some time⁹⁷⁰.

Water Undertakers rules Amendments

The following were the proposed new Rules relating to chemical and bacteriological quality in 1959⁹⁷¹.

A new section to be headed "Quality of Water Supplied for Domestic Purposes" was proposed⁹⁷².

970 McCartney J.S (1959), Complaints Regarding Quality of Water Supplies by Private Water Undertakings. Kenya National Archives. BY/35/15, 10th, August 1959.

971 Ag Chief Hydraulic Engineer (1959). Water Undertakers Rules Amendments. Kenya National Archives. BY/35/15, 19th, August 1959.

972 Ag Chief Hydraulic Engineer (1959). Water Undertakers Rules Amendments. Kenya National Archives. BY/35/15, 19th, August 1959.

Rule 19. Water undertakers were to be classified in relation to the average quantity of water they would supply per day for domestic purposes, as follows⁹⁷³.

Type A Undertaking. Supplies in excess of 13,638 m³ per day.

Type B Undertaking. Supplies in excess of 2,273 m³ per day, and not exceeding 13,638 m³ per day.

Type C Undertaking. Supplies in excess of 91 m³ per day, and not exceeding 2,273 m³ per day.

Type D Undertaking. Should not supply in excess of 91 m³ per day⁹⁷⁴.

Rule 20. A water undertaker was to provide in his mains and communication pipes only wholesome water, which had been:

Obtained from a source free of pollution

Obtained from a source adequately purified by natural agencies

Adequately protected by artificial treatment⁹⁷⁵.

Rule 21. A Water Undertaker was to ensure that the water was of satisfactory bacteriological quality and was to arrange for presumptive Coli-Aero genes tests to be made at not greater than the following⁹⁷⁶

Type A and B Undertakings were consistently to produce a class I water, and if tests showed that it was either class II, III or IV immediate steps were to be taken to improve the quality to class I standard⁹⁷⁷.

Type C Undertakings were consistently to produce class I or II results, and only class I being acceptable if the supply was sterilized. If class III or IV results were obtained immediate steps were to be taken to improve the water quality⁹⁷⁸.

Type D Undertakings were to produce class I results if the supply was sterilized. However, if class III or IV results were obtained and the supply was sterilized then immediate steps were to be taken to improve the quality. In addition, all unchlo-

973 Ag Chief Hydraulic Engineer (1959). Water Undertakers Rules Amendments. Kenya National Archives. BY/35/15, 19th, August 1959.

974 Ag Chief Hydraulic Engineer (1959). Water Undertakers Rules Amendments. Kenya National Archives. BY/35/15, 19th, August 1959.

975 Ag Chief Hydraulic Engineer (1959). Water Undertakers Rules Amendments. Kenya National Archives. BY/35/15, 19th, August 1959.

976 Ag Chief Hydraulic Engineer (1959). Water Undertakers Rules Amendments. Kenya National Archives. BY/35/15, 19th, August 1959.

977 Ag Chief Hydraulic Engineer (1959). Water Undertakers Rules Amendments. Kenya National Archives. BY/35/15, 19th, August 1959.

978 Ag Chief Hydraulic Engineer (1959). Water Undertakers Rules Amendments. Kenya National Archives. BY/35/15, 19th, August 1959.

minated type D Undertakings were to ensure that consumers were advised that the water was not sterilized and thus they should boil drinking water⁹⁷⁹.

It was also proposed that wherever type A, B or C undertakings and chlorinated type D Undertakings received test results indicating that the water was class III or IV. All consumers were to be advised to boil all drinking water until such a time as an acceptable quality had again been achieved, as would be confirmed by other bacteriological examinations⁹⁸⁰.

Rule 22: A water Undertaker was to ensure that the physical characteristics of the water satisfied the following laid conditions.

Turbidity was as expressed in the silica scale and the turbidity in parts per million was not to exceed the following.

3 in the cases of type A and B undertakings.

5 in the cases of type C undertakings.

10 in the cases of type D undertakings⁹⁸¹.

The water was to have no objectionable taste or odour other than one introduced chemically for purification of the water. This however, was only supposed to be for temporary periods when special processes might have to be tested or in the consumers' interests⁹⁸².

Rule 23: A water undertaker was to ensure that the chemical characteristics of the water satisfied the following laid conditions and was expected to have chemical analysis made not less than once per annum subject to facilities being available⁹⁸³.

The following substances were not to occur in excess of the stated concentration⁹⁸⁴.

Lead 0.1 ppm

Arsenic 0.05 ppm

979 Ag Chief Hydraulic Engineer (1959). Water Undertakers Rules Amendments. Kenya National Archives. BY/35/15, 19th, August 1959.

980 Ag Chief Hydraulic Engineer (1959). Water Undertakers Rules Amendments. Kenya National Archives. BY/35/15, 19th, August 1959.

981 Ag Chief Hydraulic Engineer (1959). Water Undertakers Rules Amendments. Kenya National Archives. BY/35/15, 19th, August 1959.

982 Ag Chief Hydraulic Engineer (1959). Water Undertakers Rules Amendments. Kenya National Archives. BY/35/15, 19th, August 1959.

983 Ag Chief Hydraulic Engineer (1959). Water Undertakers Rules Amendments. Kenya National Archives. BY/35/15, 19th, August 1959.

984 Ag Chief Hydraulic Engineer (1959). Water Undertakers Rules Amendments. Kenya National Archives. BY/35/15, 19th, August 1959.

Selenium 0.05 ppm
Hexavalent Chromium 0.05 ppm
Phenolic compounds 0.001 ppm

The following substances were preferably not to occur in excess of the following concentrations⁹⁸⁵.

Fluoride 1.5 ppm
Copper 3.0 pp
Iron 0.3 ppm
Manganese 0.3 ppm
Magnesium 125 ppm
Zinc 15 ppm
Chlorides 250 ppm
Sulphates 250 ppm⁹⁸⁶

Rule 24. It was further proposed that at the discretion of the Minister, who should take into account the quality of raw water, alternative sources of supply and any other pertinent factors, any of the provisions of the Rules 20 to 23 could be waived in any particular case where it could be shown a good reason for that⁹⁸⁷.

Supply of Water for Domestic Purposes

The followings Rules were suggested concerning supply of water for domestic purposes.

- (1) That a water undertaker would lay any necessary mains and would also bring water to any area within his limits of supply if he was required to do so by the owners and occupiers of premises in that area who would require a supply of water for domestic purposes⁹⁸⁸.

If the water undertaker failed to do as required above within twelve months of receipts of requisition for a supply of water under the provisions of this rule, whether he was a public or local authority, was guilty of an offence and liable

985 Ag Chief Hydraulic Engineer (1959). Water Undertakers Rules Amendments. Kenya National Archives. BY/35/15, 19th, August 1959.

986 Ag Chief Hydraulic Engineer (1959). Water Undertakers Rules Amendments. Kenya National Archives. BY/35/15, 19th, August 1959.

987 Ag Chief Hydraulic Engineer (1959). Water Undertakers Rules Amendments. Kenya National Archives. BY/35/15, 19th, August 1959.

988 Ag Chief Hydraulic Engineer (1959). Water Undertakers Rules Amendments. Kenya National Archives. BY/35/15, 19th, August 1959.

to a fine not exceeding one thousand shillings and, a further fine not exceeding one hundred shillings for each day on which his default continued after conviction unless he proved that, the failure to do so was unavoidable⁹⁸⁹.

- (2) Subject to the rules, an owner or occupier of a premise within the limits of supply who had complied with the provisions of this rules relating to laying of a service pipe and the payments or tender of any fee payable before water was supplied to such premises, was entitled to demand and receive from a water undertaker a supply of sufficient water for domestic purposes, unless:

The works of the undertaker were not capable of supplying such water, or

The taking of such water would prejudice the supply to other existing consumers, or

Such supply could not be made owing to the execution of necessary works, or failure of such owner to comply with any provision of law relating to the water undertaking, or

The supply was demanded from a trunk main.

If a water undertaker, not being a public or local authority, failed to furnish or maintain such supply he was guilty of an offence and liable to a fine not exceeding one hundred shillings and a further fine not exceeding five shillings for each day on which the default continued after notice thereof from the person aggrieved⁹⁹⁰

- (3) A water undertaker was to provide in the mains and communication pipes of his works a supply of water sufficient for the domestic purposes of all owners and occupiers of premises within his limits of supply who under the provisions of these Rules were entitled to such supply⁹⁹¹.

The above Rule was not to be applied in cases where water was mineralised and there was no satisfactory alternative supply and it was deemed by the member not to be economical to demineralize such water⁹⁹².

989 Ag Chief Hydraulic Engineer (1959). Water Undertakers Rules Amendments. Kenya National Archives. BY/35/15, 19th, August 1959. The Supply was Demanded from a Trunk Main.

990 Ag Chief Hydraulic Engineer (1959). Water Undertakers Rules Amendments. Kenya National Archives. BY/35/15, 19th, August 1959.

991 Ag Chief Hydraulic Engineer (1959). Water Undertakers Rules Amendments. Kenya National Archives. BY/35/15, 19th, August 1959.

992 Ag Chief Hydraulic Engineer (1959). Water Undertakers Rules Amendments. Kenya National Archives. BY/35/15, 19th, August 1959.

- (4) Where there existed within the limits of supply of a water undertaker a source of water other than that supplied by the water undertaker which, in the opinion of a medical officer of health, did not provide a suitable supply of water for drinking and domestic use, the medical officer had powers to order such alternative source of supply to be closed. He could also compel users of such water to take a supply from the water undertaker⁹⁹³.

Wherever such an order was made the owner or occupier of any premises, or any person, previously using the alternative supply was supposed to use the water supplied by the water undertakers⁹⁹⁴.

However, if the owner or occupier of any premises failed to comply with such an order within fourteen days from the date thereof, the water undertaker, on receipts of a written order from medical officer of health, he had the powers to enter in such premises, install the necessary water fittings, and provides a supply of water. He was to recover from such owner or occupier the expenses reasonably incurred in so doing⁹⁹⁵.

Operation and Maintenance of Water Supply Installations for Government Departments

In 1953, it was reported that water supplies in Government institutions was classified into two categories. These were⁹⁹⁶.

Class A: These supplies involved full treatment or employing machinery of a complex character. It was not readily understood by untrained mechanics⁹⁹⁷.

Class B: These supplies involved no water treatment and the operation of machinery of a simple character. These supplies included most of the borehole installations. The installation was as follows⁹⁹⁸.

993 Ag Chief Hydraulic Engineer (1959). Water Undertakers Rules Amendments. Kenya National Archives. BY/35/15, 19th, August 1959.

994 Ag Chief Hydraulic Engineer (1959). Water Undertakers Rules Amendments. Kenya National Archives. BY/35/15, 19th, August 1959.

995 Ag Chief Hydraulic Engineer (1959). Water Undertakers Rules Amendments. Kenya National Archives. BY/35/15, 19th, August 1959.

996 Hydraulic Engineer (1953). Operational and Maintenance of Water Supply Installation for Government Departments. Kenya National Archives. BY/35/15 Ref DW.140/3, 23rd, March 1953.

997 Hydraulic Engineer (1953). Operational and Maintenance of Water Supply Installation for Government Departments. Kenya National Archives. BY/35/15 Ref DW.140/3, 23rd, March 1953.

998 Hydraulic Engineer (1953). Operational and Maintenance of Water Supply Installation for Government Departments. Kenya National Archives. BY/35/15 Ref DW.140/3, 23rd, March 1953.

The hydraulic Branch did the designing and construction of the scheme, while the operation and maintenance work was normally provided by the Department or Institution concerned, with occasional visits of inspection by the public works department designed to ensure that the machinery was being properly maintained⁹⁹⁹.

In the case of these supplies, the existing arrangements worked reasonably well, but as there were no funds available to the Public Works Department, the department concerned was to provide funds whenever a major overhaul or replacement was required. These repair services could be provided at cost, plus the normal charge of overheads¹⁰⁰⁰.

In the case of class A supplies, things were very different. Here a trained operator was normally essential. It was further reported that it took years to train an operator in the proper management of a treated water supply, and means were to be found to provide replacement in the case of sickness or of long leave. It was thus suggested that the supplies that falls in this class should remain under the full responsibility of the Public Works Departments. The Department had full resources to provide for both the operator and the detailed inspection, which all operators required in order to maintain the supplies efficiently¹⁰⁰¹.

It was considered that partial control of such supplies would not yield satisfactory results. It was reported that it had been suggested at various times that certain institutions should appoint their own men, and only rely to the Public Works department to deal with any serious difficulties or to repair any major breakdown¹⁰⁰²

This was not a satisfactory approach as frequent breakdown could be avoided by careful maintenance. This was considered to be particularly so in the case of treated water supplies.

In addition, it was reported that the even best of African operator needed constant supervision to ensure that they do not lose interest in the proper operation of their water supply, and in general Government institutions were unable to give the operators the necessary supervision to ensure correct treatments. It was concluded that the Public Works Department could not take responsibility for the proper functioning of a water supply, which they do not control and maintain¹⁰⁰³.

999 Hydraulic Engineer (1953). Operational and Maintenance of Water Supply Installation for Government Departments. Kenya National Archives. BY/35/15 Ref DW.140/3, 23rd, March 1953.

1000 Hydraulic Engineer (1953). Operational and Maintenance of Water Supply Installation for Government Departments. Kenya National Archives. BY/35/15 Ref DW.140/3, 23rd, March 1953.

1001 Hydraulic Engineer (1953). Operational and Maintenance of Water Supply Installation for Government Departments. Kenya National Archives. BY/35/15 Ref DW.140/3, 23rd, March 1953.

1002 Hydraulic Engineer (1953). Operational and Maintenance of Water Supply Installation for Government Departments. Kenya National Archives. BY/35/15 Ref DW.140/3, 23rd, March 1953.

1003 Hydraulic Engineer (1953). Operational and Maintenance of Water Supply Installation for Government Departments. Kenya National Archives. BY/35/15 Ref DW.140/3, 23rd, March 1953.

The National Water Master Plan spelt the framework for development of water supply in rural areas. The plan separated high potential areas and Arid and Semi-Arid areas. In high potential areas the plan called for development of piped systems where water was supposed to be supplied to the consumers by a combination of individual connection and water kiosks, while in ASAL, it called for provision of safe and sustainable water, primarily through water point sources.

The Ministry of Land Reclamation, Regional and Water Development intended to have communities whether rural or urban, in both high potential areas and ASAL had improved quality water supplies, using systems that were environmentally sustainable and economically affordable¹⁰⁰⁴.

To achieve that, the Ministry devoted the five years to promote active consumer participation in the management of water supplies. Methods on support to consumers in forming alternative community based water supply management, training of communities, equipping the ministry's technical staffs with technical know-how, gradual but systematic hand over of large treatment multi-piped water supplies¹⁰⁰⁵.

The Rural Domestic Water Supply and Sanitation Programme II (RDWSSP/II)

In 1994, six consultants were deployed by the government of Kenya and the government of Netherlands to review the Rural Domestic Water Supply and sanitation Programme's achievement and to recommend how to steer it further ahead. The review team was expected to visit 28 projects in Nyanza and hold extensive discussions with government departments, NGO's and individuals in Nairobi, Kisumu and the six district towns in Nyanza province.

The RDWSSP/II programme implemented a water and sanitation projects with strong emphasis on participation and self-reliance of the communities involved. The decentralisation of the programme was successfully achieved with the establishment of independent implementing unit.

Rural Water Supply Programme Evaluation (1976)

In the 1974–1978 Development plan, the major aims of the government development strategy were social justice, individual liberty and economic independence. Controlled exploitation of water resources formed one of the mechanisms for the achievement of those goals. In Kenya vital role of water in rural development policy was recognised in 1960s and substantial efforts to exploit the water resources were

1004 Ministry of Land Reclamation Regional and Water Development (1993). Report on the 1993 Provincial/District Water Engineers' Conference. 18th to 20th August 1993. Kericho.

1005 Ministry of Land Reclamation Regional and Water Development (1993). Report on the 1993 Provincial/District Water Engineers' Conference. 18th to 20th August 1993. Kericho.

made. Inadequate rural water supply was first seen as the potential constraint in high potential areas of the country.

In high potential areas, the population pressure was acute and agricultural development, particularly in the agricultural sector, had reached a stage where water supply was required for development to continue. On the other extreme, in the arid areas, large sections of the population were experiencing severe hardship from repeated droughts. It was considered that improvement in water supply would alleviate both the human suffering and be a major input to assist in exploiting the livestock potential of these areas. The government's long term objective was to provide a safe supply for domestic and livestock use for the whole population by the year 2000.

Evaluation of Community Water Supply and Sanitation Projects (2000)

A participatory, joint evaluation of water and sanitation projects was held in western Kenya, involving three sector projects in the region. CARE-Kenya's, the Kenya-Netherlands Rural Domestic Water Supply and Sanitation Programme (RDWSSP), and the Kenya-Finland former KEFINCO project works were evaluated in late 1999 into early 2000 by a team of consultants from NETWAS international, NETWAS Uganda, Matrix Consultants and a project staff drawn from the three agencies. Some of the findings of the evaluation are presented in Table 3.51¹⁰⁰⁶.

Table 3.51: Water supply projects achievements

Agency	Implementation Period	Technologies adopted	Water points Constructed
Kenya/Netherlands Rural Domestic Water Supply and Sanitation Programme.	1983 - 1995	Spring protection Hand dug wells Hand drilled wells Machine drilled boreholes Gravity Flow Systems	1496
CARE-Kenya SHEWAS Project	1994 - 1999	Roof catchment systems Shallow wells Spring protection	265
Kenya-Finland KEFINCO (CWSMP)	1984 - 1995	Spring protection Gravity fed schemes Machine drilled boreholes Solar pumped GFS	577

¹⁰⁰⁶ NETWAS International (2000). Evaluation of Water and Sanitation Projects in Western Kenya, Nairobi, Kenya.

It was observed that consumers mainly used the water for domestic purposes. It was also observed that within the three projects cumulatively, a wide range of Village Level Operation and Maintenance technologies were adopted. However, Communities did not always display awareness of many of these options, and appeared to have been given minimal choice in the designs of their water supply. The practice of instituting village level caretakers or pump attendants was widely evidenced within the programmes. The programmes created awareness about the importance of raising funds for operation and maintenance¹⁰⁰⁷.

Gender issues on community water supply: While studying gender issues relating to the Community Water Supply Management Project, Kunguru reported that Men (81.5%) owned land on which water facilities were constructed. On the other hand, women and children (83.3%) collected water for the family use and performed bulk of the household chores on regular basis and although women had access to resources, they did not control them. It was the duty of men to build latrines (100%) while women's (50.8%) to maintain them¹⁰⁰⁸

Rural Water Policy

During the start of the post independent period, the water sector in Kenya was characterised by very poor financial performance, and as a consequence, services could not be expanded as planned. The government was far from being able to uphold its promise of Water for all by 2000¹⁰⁰⁹. By the 1990s, it emerged that the government lacked sufficient resources to match communities' water needs. This culminated in the National Policy on Water Resources Management and Development Sessional Paper No. 1 of 1999, which was first drafted in 1992. Other policy blueprints include the Water Act 2002, the Country Strategy on Water and Sanitation Services and Country Strategy on Integrated Water Resources Management¹⁰¹⁰.

The post independent period further introduced major institutional changes in Kenya. The District Focus for Rural Development policy introduced in 1983 provides the framework of decentralized government. Sectoral department were officially represented throughout the hierarchy of district, divisional and locational administrative units. This led to customary right notion proved not only flexible but also ambiguous,

1007 NETWAS International (2000). Evaluation of Water and Sanitation Projects in Western Kenya, Nairobi, Kenya.

1008 Kunguru (2000). Community Water Supply Management Project. Gender Study Report. Kakamega, Kenya.

1009 Nilsson D and Nyanchaga E. N (2008). Pipes and Politics: A Century of Change and Continuity in KENYAN Urban Water Supply. Cambridge University Press, United Kingdom.

1010 Wambua S (2004). Global Issue Paper, No. 8: Water Privatization in Kenya, Heinrich Boll Foundation. March, 2004.

so that commonly the nature of custom was contested. A key issue was the extent to which processes of commoditisation of access to water were contested or accepted¹⁰¹¹.

In the late 1970s, Ministry of Water Development commissioned several studies supported by SIDA. The water use study of 1983 argued that the MoWD should be divested of operation and maintenance responsibilities. Similarly the operation and maintenance study of 1983 made strong representations in favour of decentralisation. In effect, therefore, these reports called for reforms revolving around the initiation of changes in the management of schemes with a view to: enabling the MoWD gain effective control over its schemes; decentralizing management, operation and maintenance to appropriate levels for rapid and effective response to scheme specific happenings; increasing the level of consumer participation and responsibility in the management; increasing the level of equity in the social distribution of scheme waters; and generating resources needed for operation and maintenance from the consumer.

These reports, however, warned that without these reforms the water sector shall increasingly find it difficult to operate and maintain the schemes; and generate the resources required for the much needed expansion of its investments to reach the majority of population without access.

In order to ensure success of this new, ambitious programme, the Government took over several water supplies previously managed by the local communities, local authorities and other public and private institutions. For instance, in 1980 during the water decade, there was the ministry's slogan of "Water for All by the year 2000". This undertaking was, however, short-lived as the Government soon realized that resources for sustaining the services were not forthcoming as the economy of the country was on the decline.

In 1979, the First National Water Master Plan (NWMP) was developed through Swedish assistance and remained the main guiding plan for water development until 1992 when Japan International Cooperation Agency in conjunction with Kenya Government formulated the second NWMP¹⁰¹². Up to early 1990s, the implementation of rural water supplies were based on supply-driven approach (SDA) development strategy with high construction targets that left little opportunity for community involvement. The SDA strategy was found to be non-viable and thus a demand-driven approach (DDA) strategy was introduced.

Participation in rural water development projects was emphasized and was seen to be most effective in 1980s. This was achieved through a policy shift away from social programmes to cost sharing, retrenchment, sale of parastatals and privatisation

1011 Bernstein H., Hulme D. and Woodhouse P. (2000). *African Enclosures? The social Dynamics of Wetlands in Drylands*. Oxford: James Currey, 2000,

1012 Republic of Kenya/Japan International Cooperation Agency, JICA (1992). *The Second National Water Master Plan*. 1992, Nairobi, Kenya.

of some government functions, price and import decontrols, removal of government subsidies, and budget rationalisation¹⁰¹³.

In 1988, the president ordered that National Water Conservation and Pipeline Corporation (NWCP) be established, under the State Corporations Act. This was to enhance the operation of water supplies on commercial basis. Basically it was expected to: commercialise water sector operations, to achieve financial autonomy in water operations, to improve performances and efficiency of water schemes and to reduce dependence on public funding of independent water schemes¹⁰¹⁴.

By 1993, the SIDA emphasised on projects involving communities, financial management to the communities and other organisations, and support to NGOs and sub-sectors which were very successful¹⁰¹⁵. This was necessary in the face of an economic recession characterised by low growth rates, dwindling public resources and reduction/discontinuation of donor aid. During this same period, Non-Governmental Organisations (NGOs) became increasingly present as key players in the development process. The Kenya government development plan (1994-96) seeks to restore economic growth and foster sustainable development. In addition, even though the plan intended to build on past experience, its main aim was to adopt (new) policies that would enable Kenyans to best cope with the changing economic and social conditions of the last five years. Hence, there was intention to limit direct participation in many spheres of the public sector in favour of private sector activity. Government however recognised that although the structural adjustment programmes were expected to bring about growth in the long-term, these policy changes had, in the short run exposed the poor to high levels of risk.

The reforms were accused of having taken away basic welfare from the poor by instituting cost-sharing in basic services such as health, water and education¹⁰¹⁶. These measures were said to have accentuated the plight of the poor who formed 46 percent of the rural population. Hence, in its 1994/95 budget, the government made a provision to address the social dimensions of development to cushion the poor from the effects of structural reforms. In addition, in order to increase its opportunities, government called upon Non-Governmental Organisations (NGOs) and the donor community to support initiatives aimed at addressing the offshoots of structural reforms¹⁰¹⁷.

1013 Republic of Kenya (1994). Development Plan 1994-96. Nairobi: Government Printers.

1014 Skyttä, T. K., Ojanpera, S. and Mutero, J (2001). Evaluation of Sector Performance. Report of Evaluation Study. Finland's Support to Water Supply and Sanitation 1968-2000. Unit for Evaluation and Internal Auditing. Ministry of Foreign Affairs, Department of International Development Cooperation. Helsinki, Finland. April 2001.

1015 Republic of Kenya (1993). Report on the 1993 Provincial/District Water Engineers' Conference. Ministry of Land Reclamation, Regional and Water Development. 18th -20th August 1993.

1016 Republic of Kenya (1994). Development Plan 1994-96. Nairobi: Government Printers.

1017 Republic of Kenya (1994). Development Plan 1994-96. Nairobi: Government Printers.

Non-governmental organisations (NGOs) have participated in the development of community water supply and sanitation both in rural and urban areas. NGOs have been acting as important mediators in the process of rural development over the last decade in Kenya. They have been widely acclaimed as ‘agents of change’, acting as ‘catalysts’ in development; they are not only entering into partnership with national and international agents, but also are pioneering new techniques and approaches in participatory methods at the grass-roots level. As an effective ‘buffer’ between the state and the people, they have been able to gain the confidence of both sides and to act as intermediaries in bringing the development message ‘down’ to the communities. Small private non-profit organisations interested in the welfare of the people have thus been able to circumvent the bureaucratic process and to act rapidly and efficiently in times of crises. They have earned a high reputation for accountability, thereby forming channels for donor and international agency funding. As a result, they have increasingly been entrusted with supporting development projects in the country¹⁰¹⁸.

The 2002-2008 National Development plan¹⁰¹⁹ indicated that about 75 percent and 50 percent of the country’s urban and rural population respectively have access to safe drinking water.

This has been achieved through provision of some 330 gazetted water sources countrywide, accounting for 80 percent of the served population; while the rest (20 percent) of the population is served by non-gazetted schemes. There are over 1,800 water supplies that are operational out of which about 1,000 are public operated schemes. Non-Governmental Organisations, self-help groups and communities run the rest. Similarly, there exist about 1,782 small dams and 669 water pans in the country of which 1,183 are operational and 1,168 silted but operational; 100 have dried up or have been abandoned. In addition there exist about 9,000 boreholes the majority of which require rehabilitation or replacement.

The 2002-2008 National Development plan¹⁰²⁰ indicated that out of the 142-gazetted urban areas in Kenya, only 30% have sewerage systems. According to Nippon Koei¹⁰²¹, majority of sewers constructed in the 1950s, 60s and 70s and have never been inspected and are in poor structural condition. Development has exceeded the available hydraulic capacity of older sewers resulting in frequent blockages,

1018 Ministry of Water Development, Kenya and Swedish International Development Authority (1992). *Delineation Study the Water Sector in Kenya*, July 1992.

1019 Republic of Kenya (2002a). *National Development plan 2002-2008. Effective Management for Sustainable Economic Growth and Poverty Reduction*. Government Printers, Nairobi, Kenya.

1020 Republic of Kenya (2002a). *National Development plan 2002-2008. Effective Management for Sustainable Economic Growth and Poverty Reduction*. Government Printers, Nairobi, Kenya.

1021 Nippon Koei (1998). *The Aftercare Study on the National Water Master plan in the Republic of Kenya. Final Report, Executive Summary*. Japan International Cooperation Agency, Ministry of Water Resources, Republic of Kenya. November 1998.

overflows and surface flooding. This situation has posed serious environmental and health problems with main sewer systems in most urban centres suffer from constant breakage or leakage, inadequate capacity to handle their full sewerage load. A number of factories and enterprises are known to discharge effluents through mainstream rivers and valley depressions causing high pollution levels. Thus, effluent pollution makes rivers, streams and dam water unsafe for domestic and livestock consumption.

In 1974, UNICEF carried out a follow up study of the projects it had implemented covering 197 out of 561 schemes in eleven districts and six provinces. Some of the problems encountered by the Rural Water Supplies Programme projects are as outlined below¹⁰²²:

Operation and Maintenance: Many of the schemes found not operational during the evaluation were due to improper attention by the caretaker due to lack of funds to buy spares, employ a permanent pump attendant and fuel and lubricating oil.

Lack of transport: Transport of parts or material to make repairs was often lacking.

Lack of standard procedure for operating and maintaining a supply: Supplies using mechanical pumps and engines were affected as the Ministry of Health had no training school for pump and engines.

Failure of water source: Along the coastal hinterlands, several dry years resulted in the drying up of wells and springs and streams and the abandonment of water supplies dependent on these sources.

Sabotage or theft of materials: Sabotage was thought to be by those who owned hand-carts, donkey-carts, etc. and engaged in bringing water to the village from a river, spring or other source. The Ministry of Health supply was considered to be a direct threat to their livelihood and these people were thought to be responsible for the pipe breakage and destruction of equipment that rendered a supply inoperative. In other communities, thieves stole the brass and copper fittings from pumps, engines and hydrams for their scrap value, putting the supply out of commission.

Poor design and construction: Some schemes had failed to deliver water due to design errors, wrong type or size of equipment and piping being installed.

1022 Wignot (1974). A report on the condition of UNICEF assisted demonstration rural water supplies in Kenya. UNICEF regional office, Nairobi.

Revenue collection: Schemes failed where the local people were not willing to support the projects by paying for a water supply, hence it could not function properly.

Distance between schemes: This made it difficult for a maintenance man or unit to service the schemes regularly, or for an operator to pump water regularly, as in some divisions where one operator was responsible for a group of schemes.

Human factor: It was evident from field visits that in those areas where the health officers were generally interested and concerned with the development of good water supplies, the supplies tended to be well operated and maintained than where the health officer was not so interested.

Breakage of Hand pumps: Some type of hand pumps such as Craelius, Oasis and Simac could not withstand hard use by the public and very expensive to repair when they broke down. Hand pumps were installed and left to run as long and possible and when one broke down; it was abandoned, or removed and never replaced, or kept in repair only as long as funds were available.

Rural schemes

A summary of the level of service and population coverage under rural water supply by 1983 in the whole Country is illustrated in Table 3.52.

Table 3.52: Level of service and population coverage of rural schemes

Province	Schemes			Rural			Urban			Estimated population coverage (%)
	Kiosks	Individual connections		Kiosks	Individual connections		Kiosks	Individual connections		
		Rate	flat		metered	Rate		flat	metered	
Central	41	88	8,344	5,463	7.5-9.2	5	0	9,037	84	
Eastern	40	53	6,459	3,960	5.0-5.1	11	1	6,337	16	
Coast	34	94	0	1,209	3.0-3.3	50	50	28,905	60	
Western	27	77	2,231	1,928	3.3-3.4	26	0	5,705	30	
Nyanza	37	187	296	849	1.9-2.0	4	13	3,749	42	
Rift Valley	85	17	1,192	2,014	1.2-1.5	0	69	3,500	36	
North Eastern	10	0	126	122	0.7-0.8	0	219	1,395	42	
Total	274	516	18,648	15,545	3.5-4.2	96	352	64,333	50	

NB: These estimates were not based on design population or water produced, but on the available information on the number of kiosks and individual connections. The estimated coverage was optimistic since it was based on the information provided by the District water office reports which, when checked, proved too high. Individual connections did not allow for disconnections which were substantial in number¹⁰²³.

¹⁰²³ Ministry of Water Development (1983). Water Use Study, Main Report 1983. Ministry of Water Development Nairobi Kenya.

3.4 Private Sector Involvement

3.4.1 Private Companies

In 1898, the first attempts to license a private water provider were made. However the private developer was not successful. By 1914, the large-scale European farmers played a key role in development of private water services mostly in their farms.

In September 1914, the Government went into agreement with Captain James Archibald Morrison of the Upper Nairobi Township and Estate Company Limited for the supply of water to the up-market areas of Nairobi such as Muthaiga. The company operated until around 1923 when Muthaiga water supply was taken over by the Nairobi Municipal Corporation¹⁰²⁴.

In the 1920s, Mr. Sheikh Ali bin Salim a private operator, was contracted to supply the Kilifi Town with water that served the public including Government employees in the station¹⁰²⁵.

Nairobi, because of its relative significance as a colonial capital and rapid population growth, witnessed a fast growth of private water providers. For example, by 1957 Nairobi had 17 Gazetted private Water undertakers including in areas such as Spring Valley Estate, Roselyn estate, Ridge Ways Estate, Mwituu Estate, Kibigara Estate, Ruaraka Mango Farm, Garden Estate, Roysambu estate, Karen Estate, Kitisuru Estate, Kuwinda Estate, Kitembe Estate, Mirema Estate, Tigoni Estate, Kirawa Water Co. Ltd, Kikuyu Estate, and Green Hills Estate near Limuru¹⁰²⁶.

Of late privatisation has been taken as a generic term used to describe a range of policy initiatives meant to alter ownership or management away from the Government in favour of the private sector. It is the nature of privatisation to entail a massive and radical reallocation of available productive resources, as it is a tool of attaining the expansion of private markets and business consensus. On the Kenyan context, privatisation first became a major policy tool in the 1980s and it begun with the IMF-World Bank imposition of structural adjustment programs (SAPS) which forced the governments to free markets and pull out of loss making state enterprises whose lifeline was government subventions¹⁰²⁷.

1024 Colony and Protectorate of Kenya (1913-1923). Muthaiga Water Supply. Kenya National Archives, Ref: AG/43/103, Nairobi, Kenya.

1025 British East African Protectorate (1898). Sub-Commissioner office, Kenya National Archives, Ref No. PC/CP/1/1/124, Folio No.224, Nairobi, Kenya.

1026 Chairman's Report (1957). Nairobi Peri- Urban water supplies. Kenya National Archives, Ref: WAT/ 36/24/212, Nairobi, Kenya.

1027 Anyang' Neon' (Ed) *et al*, (2000). The Context of Privatization in Kenya. Academy Science Publishers, Nairobi.

By the year 2004, it was estimated that Kenya needed to invest \$4 billion to ensure access to clean and safe water by all Kenyans. This was almost the equivalent of the country's total annual national budget. Nairobi alone required a staggering \$150million while Mombasa, Kenya's second largest city and a major tourist attraction required \$ 200 million. Kisumu, Kenya's third largest city which lies on the shores of Africa's largest fresh water mass, Lake Victoria, requires \$50 million¹⁰²⁸.

Since the articulation of the policy framework on economic reforms (1996-98), the National Development Policy (1997-2001) and the National Water Policy (1998), the government's emphasis was favoured increased community and private sector participation. At the same time, there has been emphasised on evolving an enabling institutional framework that vests increasing autonomy on Local Authorities in the management of water resources.

The suitability of full-fledged privatisation of Kenya's water sector in the form of ceding control over supply of water to private enterprises has however been opposed on the basis that it would disadvantage the poor at the expense of consumers with purchasing power. Understandably, the focus in Local Authorities involved in privatisation has been a focus on emphasising commercialisation based on an application of business principles of sustainability in managing water resources. Most Local Authorities are convinced that commercialisation would ensure efficient provision of water at affordable prices. In the main, the predominant challenge facing Kenya in the privatisation of her water resources is the need to strike a balance between achieving market efficiency vis-à-vis promoting social equation access to this vital resource especially by the most vulnerable sections of the population¹⁰²⁹.

3.4.2 Commercialisation of Water and Sanitation Services

Throughout the history of water development in Kenya, the private sector has been involved in small scale and intermittent way. However, today the role of the private sector is becoming more common as improved water provision is increasingly becoming an economic good rather than a social one. The public institutions, which after independence held water more as a social good, have been unable to render effective service hence paving way for the private sector to inject commercial values to water supply in the country. Thus the move towards privatisation and redefining the role of government in provision of water could therefore be seen as recognition

1028 Wambua S (2004). Water Privatisation in Kenya. Global Issue Paper No. 8. March 2004. Heinrich Boll Foundation Berlin Germany.

1029 Wambua S (2004). Water Privatisation in Kenya. Global Issue Paper No. 8. March 2004. Heinrich Boll Foundation Berlin Germany.

of its own limitations and shortcomings. Even though the government indicated that privatisation did not constitute a policy component on the sector, it was a discernible feature of its shift on water provision.

But the government has been at pains to distinguish between privatisation and commercialisation. It favors the latter and was keen on the formation of autonomous and competent water services providers under which efficiency in service delivery can be attained whilst ensuring that respective local Authorities retain measure of control. In Kenya, it is now a common trend for local Authorities to form municipal companies run on strict commercial lines under “agency contracts” from the parent Local Authority. An experience of Local Authorities which have embarked on commercialisation such as Nyeri, Eldoret and Kisumu are often cited as examples of how efficiency can be infused without ceding away control to private enterprises¹⁰³⁰.

Through commercialisation, the Water Act requires local authorities to form autonomous water and sewerage companies with independent boards of directors to provide water services and re-invest water revenues in service delivery improvement. However, the companies would not own the water resources but their licensors currently constituted as regional Water Services Boards. The boards are also vested with powers to license private water companies which could be a potential source of conflict with Local Authorities¹⁰³¹.

To carry out the commercialisation of the services, the Ministry of Local Government with the support of the German Technical Cooperation Agency (GTZ) established the Urban Water and Sanitation Management (UWASAM) project aimed at assisting local authority in self-sustainability for their water and sanitation services through commercialisation and privatisation. The initiative was carried out in phases, that is, a pilot phase in July 1987 - December 1993 (phases I and II) in three municipalities. In the January 1994 - December 1996 phase III, the financial management guidelines developed during the pilot phase were implemented in nine participating municipalities. It was recognized that if the financial viability was to be attained, financial autonomy from the urban councils would be required. Therefore, the water and sanitation departments were established in those nine municipalities. Although the creation of the departments created some improvements in the service provision, it soon became apparent that certain problems were inherent within the local government structure and even the creation of separate departments within that structure could not solve those problems that included: Costs covering tariffs were not introduced in order to obtain short-term political popularity; delays in the

1030 Wambua Sammy (2004), Global Issue Paper, No. 8: Water Privatization in Kenya, Heinrich Boll Foundation. March, 2004.

1031 Wambua Sammy (2004), Global Issue Paper, No. 8: Water Privatization in Kenya, Heinrich Boll Foundation. March, 2004.

approval of tariffs and budgets due to long bureaucratic approval procedures; diversion of water revenue to unrelated expenditures at the expense of the water services; and difficulty in the recruitment and retention of competent staff at all levels¹⁰³².

In April 1996, the Ministry of Local Government accepted, in principle, the need to introduce a commercial approach to the water and sanitation operations in the local authorities. Various options were considered. The most preferable was the adoption of public sector ownership and private operations and management models that were accepted for implementation on a pilot basis for four municipalities (Eldoret, Nakuru, Kitale and Nyeri). The water and sanitation companies, fully owned by the municipalities, were established under the Companies Act, Chapter 486. A corporate management team ran these companies, comprising a managing director, a commercial manager, and a technical manager, who all were accountable for the board of directors. By the end of 2002, it was only Nyeri and Eldoret companies that were operation whereas the Department of Water Development took up Kitale and Nakuru operations due to poor operations of the companies. Legal changes under the Water Act 2002 paved way for Kericho, Kisumu and Nyahururu starting operations as commercialized water and sewerage companies.

By 2000, there were two Water Management Contracts (Malindi and Tala) in the Country. In Malindi, the management contract was developed from a service contract, that is, "Improvement in Billing and Revenue Collection" contract, that was funded from the Second Mombasa and Coastal Water Supply Project (financed by the World Bank) and which ran from 1995 to December 1997. In Tala, in July 1999, the Kangundo County Council resolved to privatize the provision of water services in Tala Town by entering into a 30-year contract with Romane Agencies. The company operates all the assets for the entire water system and took over accumulated electricity bill of (\$12,000)¹⁰³³.

Runda Water Supply Company Ltd established in 1975 as a Housing Development Estate and appointed a water undertaker the same year is the only big private water supplier that by 2001 was supplying water to over 500 households of Runda Estate in the suburbs of Nairobi City operating in the country¹⁰³⁴.

1032 Urban Water and Sanitation Management (UWASAM) Project. 2001. Plan for the Second Half of Phase V. Summary of the Proceedings and Outcomes of the Worksop. 13th -14th November 2001. Nairobi.

1033 BG Associates (2002). Global Small Towns Water and Sanitation Initiative. Kenya Country Case Study. Final Draft Report. Volume I: Main Report – Comparative Analysis. Water and Sanitation Program, WSP – Africa. January 2002.

1034 BG Associates (2002). Global Small Towns Water and Sanitation Initiative. Kenya Country Case Study. Final Draft Report. Volume I: Main Report – Comparative Analysis. Water and Sanitation Program, WSP – Africa. January 2002.

3.5 Bilateral Assistance Programmes

The expectations from bilateral partners was high and a proposal made in 1977 required various donors to provide for the Kenya water development works is shown in Table 3.53¹⁰³⁵.

Table 3.53: Bilateral support in water development works

Source of Aid	1960/72 (K£)	1978/79(K£)	1979/80(K£)	1980/81 (K£)	1981/82(K£)	1982/83(K£)	Totals (K£)
UNICEF/WHO	5,172,850	-	-	-	-	-	5,172,850 or (USD 1,034,570)
SIDA	-	2,000	2,200	1,300			5,500
Japan	-	200					200
CIDA	-	80	320	2,040	2,100	810	5,350
Danida	-	70	380	400	550		1,650
Nether-lands	-		250	400	500	50	1,200
U.K	-		200	250			450
IBRD	-			1,860	2,350	1,140	5,350
Unknown	-			200	400	2,900	3,500
Totals	5,172,850	2,350	3,350	6,450	5,900	4,900	5,196,050

1035 Baker D (1978). Programmes (Exc. Settlement Water Supplies) 1978/79 to 1982/1983) Kenya National Archives, RP/9/6. Ref: WD/2/1/37, 22nd January 1978.

3.5.1 UNICEF/WHO

Initially when the Public Works Department had not been fully developed and the numbers of staff were few, the health officers under the Ministry of Health always supported water development. The provincial and district medical officers of health were always involved in the approval of town plans and eventually the development thereof or therein. The building of schools, hospitals etc. had to be approved by health officers on health grounds and hence the matter of water provision as central to public health could not be ignored. The water to be supplied to township was certified by a medical officer of health before being developed. Besides the direct role played by the persons in the health department, presence the water borne diseases accelerated the need for clean drinking water.

In 1959, the UNICEF Executive Director recommended an allocation of \$60,000 to Kenya colony and protectorate for a pilot demonstration project in Environmental Sanitation during the two years 1960/61. The environmental Sanitation Programme for Kenya was a ten-year development plan divided into two five year phases. UNICEF supplied equipment for drilling and construction of wells, latrine boring, concrete making and survey equipment, utility vehicles for supervision and trucks for transportation of supplies¹⁰³⁶.

The United Nations under UNICEF recognised the role played by clean water in prevention of communicable waterborne diseases as well as improving the health and economy of Africans. In August 1960, under the auspices of “Environmental Sanitation Programme”, WHO/UNICEF started the intervention. The main objective was to develop water supplies for the smaller rural communities. In addition to promoting awareness in the community of the benefits of adequate and safe water supplies, this integrated programme was concerned with improved methods of waste disposal in schools, health centres, markets and public meeting places¹⁰³⁷. For instance in 1959 UNICEF had agreed to assist a gravity scheme from Zania to the major portion of Muhoya location in the Nyeri District.

The scheme could allow for the piping supplies to about 588 homesteads and to 4 villages, the survey was done by ALDEV, the work was to be done by the health staff and local people, and UNICEF would help with cash and the services of an engineer¹⁰³⁸. In 1961, a new Treatment work was opened at Nyeri on 9th February

1036 The Recommendations of the Executive Director for an Allocation, Kenya, Basic Maternal and Child Welfare Services, Environmental Sanitation, 13th August 1959. File no BY/29/2, ref: E/ICEF/R.790.

1037 Wignot, R.E (1974). A Report on the Condition of UNICEF Assisted Demonstration Rural Water Supplies in Kenya. UNICEF Regional Office, Nairobi.

1038 District Commissioner, (1959). Annual Report for 1959, Nyeri District. Kenya National Archives. DC/NYI/1/1/1, 1959.

by the Minister for works, and the handing over of the water supply, together with three other water supplies situated outside the District, to the Aberdare County Council on 1st, August, 1961 began¹⁰³⁹.

It was also reported that 5,000 pounds was spent at Karatina on laying a new ring main, of a large size, erecting a 91 m³ high level Braithwaite tank and improving pumping equipment which provided greater pressure, and an adequate water supply at the new Industrial Plots. However, this was disappointing since the increase in water consumption after new reticulation only represented just over 5% of the original consumption¹⁰⁴⁰. In Othaya 700 pounds were spent in providing a more adequate reticulation system and doubling the capacity and raising the level of the Braithwaite tank, so as to provide increased pressure in the mains. And for this instance consumption had increased by 50% since the new system was brought into use¹⁰⁴¹.

In November 1964, the WHO Engineer visited Samburu and Maralal to discuss the piping of Wamba water supply. As a result of the visit 1,800 fits of pipes from UNICEF were supplied for the extension of Wamba water supply from the existing public point near the hospital to the dukas in 1965. The agreement was that the connection from the main to each duka would be entirely financed by the individual owner concerned¹⁰⁴².

From 1960 to 1972, the United Nations Children's Fund (UNICEF) provided \$US 1,034,572 worth of assistance to the programme. This contribution was in the form of mechanical water pumps and diesel engines to power them, hydrants, hand pumps, piping and related materials such as asbestos-cement roofing sheets for rain catchment at schools. The World Health Organisation (WHO) provided engineers and health inspectors as technical advisers to the programme¹⁰⁴³.

Initially, UNICEF aid was being matched by contributions from the local communities in the ratio of 60 to 40 percent respectively. The latter contributed labour and materials as well as money. As the beginning of fiscal year 1970, the central government began contributions to the programme. UNICEF assistance decreased thereafter and ceased at the end of fiscal year 1972. The central government and the local communities now share the costs.

1039 District Commissioner (1961). Annual Report for 1961, Nyeri District. Kenya National Archives. DC/NYI/1/1/1, 1961.

1040 District Commissioner (1961). Annual Report for 1961, Nyeri District. Kenya National Archives. DC/NYI/1/1/1, 1961.

1041 District Commissioner (1961). Annual Report for 1961, Nyeri District. Kenya National Archives. DC/NYI/1/1/1, 1961.

1042 Permanent Secretary Ministry of Health and Housing (1965) WHO/UNICEF Aid to Environmental Sanitation Schemes. Kenya National Archives. BY/29/11 22nd September, 1965.

1043 Wignot, (1974). A Report on the Condition of UNICEF Assisted Demonstration Rural Water Supplies in Kenya. UNICEF Regional Office, Nairobi, Kenya.

At the time of UNICEF's withdrawal, some 561 demonstration schemes had been completed or were being designed and initiated. Authorities agree that this has had the desired effect of showing the benefits of a permanent, safe water supply in the rural areas. Numerous communities in the country today are organizing committees to develop their own water supplies.

Schemes were handed over to county councils upon completion. Unfortunately, these councils had very limited resources and were unable to maintain the supplies properly. The problem was aggravated because most of the schemes were very poorly designed, and by 1973, only a half of the projects listed in programme were operational¹⁰⁴⁴.

This report is an evaluation of the present conditions of the UNICEF assisted demonstration projects. It arises out of a need felt by UNICEF for a follow-up study of its investment in the programme. The author was contracted to undertake and complete this assignment over a period of three months starting in September of 1974. During this time, visits were taken to a cross-section of the projects, interviews made with relevant persons and data collected.

Initial approval for this consultant to undertake the study was readily forthcoming from the Ministry of Health, whose officers gave their generous support and co-operation.

Transportation to visit the projects was provided by the Ministry and a Public Health Officer, Environmental Sanitation, was conscientious guide on the field visits. Health Officers and technicians in the districts visited were responsible for providing much information about the operation and maintenance of the supplies and feedback about the programme¹⁰⁴⁵.

By this time, the most important organisation was the newly created Ministry of Water Development. Its Water Department (formerly under the Ministry of Agriculture) was charged with the overall responsibility for the planning and development of water supplies in the country. Area of interest for the Ministry of Health was in building water supplies for smaller rural communities with an average population of 1200 people.

According to 1974 census, Kenya's population was 12,934,000 and the annual growth rate was estimated to be 3.5%. In regards to water development, the govern-

1044 World Health Organization (1973). Sectorial Study and National Programming for Community and Rural Water Supply, Sewerage and Water Pollution Control Report No 10.: Recommendations on Administration and Organizational Structure for Water Supply Development. Brazzaville, August 1973.

1045 World Health Organization (1973). Sectorial Study and National Programming for Community and Rural Water Supply, Sewerage and Water Pollution Control Report No 10.: Recommendations on Administration and Organizational Structure for Water Supply Development. Brazzaville, August 1973.

ment's basic goal was long term in nature. This was to bring to the entire population by the year 2000 the benefits of a safe supply sufficient to their requirements for domestic and livestock consumption. To this end, during the 1974-1978 five year plan, at a cost of 398, 000 Kenyan pounds was devised. The Ministry of Health proposed to construct 295 new supplies and improve the water quality of 225 water supplies already constructed¹⁰⁴⁶.

The Environmental Sanitation Programme assisted by WHO/UNICEF was started in August of 1960. Five hundred and sixty one rural water supply schemes were designed throughout the country to provide a piped water supply to an estimated 664,000 people. The work was carried out in nine phases over a thirteen year period although some 50 of the schemes have yet to be completely implemented. Planning, design, equipment, supply, construction and maintenance stages were standardized so that the supplies could be implemented within the frames of limited technical possibilities.

The Environmental Sanitation Programme assisted by WHO/UNICEF was started in August of 1960. A total of 561 rural water supply schemes were designed throughout the country to provide a piped water supply to an estimated 664,000 people. The work was carried out in nine phases over a 13-year period, although some 50 of the schemes have yet to be completely implemented. Planning, design, equipment, supply, construction and maintenance stages were standardised so that the supplies could be implemented within the frames of limited technical possibilities.

Planning: planning was initiated by the District Health Officers who were requested to submit to the Ministry of Health a list of the proposed communities for water supply development in their districts. Proposed schemes were listed according to order of priority for development. "This preliminary round only required the following information to be submitted"? Being the place, population to be served, public institutions to be supplied (markets, schools, dispensaries), estimated distance of the source, and estimated head between the source and the village. After studying the lists of proposed schemes, which numbered 30-40 per district, the Ministry drew up annual stages of development with schemes allocated for each year. The District Health Officers then did a detailed plan of design for these schemes, using special forms according to a standardised system.

Design and equipment: special courses were organised for the District Health Officers to supplement the information they had received during their initial 3-year training period. The DHOs were trained to follow a standard design system, including

1046 World Health Organization (1973). Sectorial Study and National Programming for Community and Rural Water Supply, Sewerage and Water Pollution Control Report No 10.: Recommendations on Administration and Organizational Structure for Water Supply Development. Brazzaville, August 1973.

hydraulic calculations, costs and submission methods. For reasons of standardisation, all equipment used in the programme is generally of one make. Reciprocating pumps and hydrams are all Blake, engines are Lister diesels. Hand pumps are mainly Craelius, Oasis and Simas. Climax windmills are used in a few of the supplies. Hydraulic calculations in the training courses were according to the standards of this equipment.

Supply: the supply of equipment and material for development of the UNICEF-assisted water supply schemes proceeded formally. The Ministry of Health, after project staff checking, inspecting and approving of the scheme designs, submitted requests to UNICEF once a year towards the end of December. The schemes had to be approved by the Eastern Africa Regional Office of UNICEF, then in Kampala, and by the Head Office in New York. After approval, orders were placed with the suppliers. When the materials arrived in the country, Ministry of Health arranged for their distribution to the various schemes. This procedure resulted in a period of 12 to 18 months between the time the District Health Officer proposed the water supply scheme to the Ministry and the time of arrival of the pumps, engines and piping.

Construction: the usual method of constructing the water supply involved the DHO, his possible representatives, the Public Health Officer and the Public Health Technician (Health Assistant), and the local community and/or county council. A health official would coordinate and supervise construction. Contractors and artisans were hired locally by the community group or county council. In some districts, for example Kirinyaga in the Central Province, artisans employed by the Ministry of Health worked on the building of the schemes. Local groups also provided casual labour, and building materials such as sand, aggregate, stone and concrete blocks. In some districts, Lorries from the Government or county councils were available for transport of materials; in other districts, transport was hired.

Operation and Maintenance: after a scheme was built the programme guidelines called for the operation and the maintenance of the supply to be undertaken by the local group, committee or county council. It should also be pointed out here that the initial emphasis was on water quantity rather than quality as the more urgent need. As the assisted communities developed the ability to operate the supply properly, treatment devices would then be introduced where necessary.

The usual practice has been for the Health Officer supervising the scheme's construction to choose one of the most capable labourers from the local community and instruct him in the operation and maintenance of the equipment. His wages are paid by the community or Local authority, which also provides money for fuel,

lubricating oil and spares¹⁰⁴⁷. In 1972, UNICEF initiated 561 water supply schemes and spent USD 1034570 in Kenya (Table 5.54).

Table 3.54: Rural water supply schemes initiated by UNICEF (1960 – 1972)

Phase	Period	Schemes	People	UNICEF Aid	Government Contribution
I	1960/61	13	30000	48523	-
II	1962/63	34	34500	126907	-
III	1964/65	39	33500	145570	-
IV	1966/67	63	66000	72900	-
V	1967/68	34	4900	93500	-
VI	1968/69	42	80000	113000	-
VII	1969/70	106	129300	250209	-
VIII	1970/71	46	47090	91303	-
		62	97730	-	121628
IX	1971/72	40	50100	92660	-
		82	76880	-	119780
Total	13 years	561	664,100	\$1,034,570	\$241,408

The Ministry of Health personnel who were involved in the programme were the Public Health Officers who were located in each division all over the country and the Public Health Technicians who were trained to be an auxiliary or assistant. The personnel's were trained at the Medical Training Centre (MTC) Nairobi. They were trained in areas of water supply, building construction, water collection and treatment, and drainage and sanitation in addition to health education, practice and administration¹⁰⁴⁸.

The rural water supplies programme was able to initiate the following number of schemes during various phases at the noted costs (Table 3.55).

1047 World Health Organization (1973). Sectorial Study and National Programming for Community and Rural Water Supply, Sewerage and Water Pollution Control Report No 10.: Recommendations on Administration and Organizational Structure for Water Supply Development. Brazzaville, August 1973.

1048 World Health Organization (1973). Sectorial Study and National Programming for Community and Rural Water Supply, Sewerage and Water Pollution Control Report No 10.: Recommendations on Administration and Organizational Structure for Water Supply Development. Brazzaville, August 1973.

Table 3.55: Conditions of the demonstration rural water supplies

District	Number of UNICEF Assisted schemes	Number of schemes	
		Working	Not Working
Siaya	12	11	1
Kericho	17	10	7
Kakamega	27	15	12
Murang'a	7	5	2
Nyeri	22	14	8
Kwale	13 (8 hand pumps)	2	11 (8 hand pumps)
Kilifi	52 (44 ")	10	42 (38 hand pumps)
Kirinyaga	11	10	1
Embu	11	7	4
Machakos	11	8	3
Meru	14	12	2
Total	197	104	93

Out of 561 schemes 197 were discussed and their condition determined Table 3.57 shows a breakdown of the schemes according to different delivery systems while Table 3.56 identifies the reasons for some of breakdowns¹⁰⁴⁹.

Table 3.56: Conditions of the demonstration rural water supplies per province

Province	Number of schemes	Delivery system	
		Working	Not working
Central	40	12-mechanical pumps 3-hand pumps 2-gravity 12-hydrams	8-mechanical pumps 3-hydrams
Eastern	36	6-mechanical pumps 15-gravity 6-hydrams	5-mechanical pumps 1-gravity 3-hydrams
Rift Valley	17	9-mechanical pumps 1-gravity	6-mechanical pumps 1-gravity
Western	27	15-mechanical pumps	12-mechanical pumps
Coast	65	2-mechanical pumps 6-hand pumps 4-gravity	3-mechanical pumps 46-hand pumps 4-gravity
Nyanza	12	11-mechanical pumps	1-mechanical pump
Total	197	104	93

1049 World Health Organization (1973). Sectorial Study and National Programming for Community and Rural Water Supply, Sewerage and Water Pollution Control Report No 10.: Recommendations on Administration and Organizational Structure for Water Supply Development. Brazzaville, August 1973.

Table 3.57: The Breakdown of non-working schemes

Number of schemes	Reason for not working
16	Due to failure of source, inadequate yield
42	Due to equipment failure, mechanical fault (mainly hand pumps)
11	Not started
11	Under construction
8	Covered by larger WD water supply
5	Others like theft of parts or sabotage

Problems encountered by the Demonstration Rural Water Supplies Programme

Operation and Maintenance: The original plan for the rural water supplies called for selection, design and construction under the supervision of Ministry of Health. Assistance from local groups in the form of money, materials and labour, assistance from WHO in the form of technical advisers, and assistance from UNICEF in the form of material was also called for.

After the scheme was built, operation and maintenance was to be undertaken by the local group, committee, or local authority such as the country Council. Many of the schemes, which were not operating as the time of inspection, were not being looked after properly by the caretaker group. A main factor was lack of funds. Many of the county councils were financially in trouble and operating “in the red”. Local groups were in a similar position, no money to buy spares, employ a permanent pump attendant, buy fuel and lubricating oil, effect repairs due to breakdowns. Inflation added to the problem¹⁰⁵⁰.

Transport: Another factor affecting the upkeep of the scheme was lack of transport. The situation was so bad that there was no transport to effect replacement parts or material to make repairs. Costs for hiring transport in the area also high. In Kericho District, for example, Lorries were hired out at KES 7 (\$US1) per one and half kilometre.

Lack of a standard procedure for operating and maintaining a supply: The Ministry of Health had no training school for pump and engines. The usual practice was for the Health Officer supervising the scheme to choose one of the most capable labourers from the local community and instruct him in the operation and maintenance of the equipment. A lot depended on the degree of experience that the Health Officer had with this equipment

¹⁰⁵⁰ World Health Organization (1973). Sectorial Study and National Programming for Community and Rural Water Supply, Sewerage and Water Pollution Control Report No 10.: Recommendations on Administration and Organizational Structure for Water Supply Development. Brazzaville, August 1973.

Failure of the source and inadequate yield: Particularly along the coastal hinterlands, several dry years resulted in the drying up of wells and springs and streams and the abandonment of water supplies dependent on these sources. Part of the problem arose from the original selection of the source by the Health Officer.

Duplication of efforts: the provision of services by Ministry of Water Development (formerly under Ministry of Agriculture) in some areas led to abandonment of the small and ineffective projects, equipment were abandoned and others used elsewhere.

Sabotage and theft of materials has occurred: the handcarts, donkey-carts, etc. water sellers saw the provision of water supply as a direct threat to their business and therefore sabotaged the effort. In other communities, thieves stole brass and copper fittings from pumps, engines and Hydrams for their scrap value, putting the supply out of commission. The villagers were often unable to come up with the funds to buy replacement parts and so projects were abandoned.

Design and Construction Errors: some schemes failed to deliver water due to design errors, wrong type or size of equipment and piping being installed, etc.

Revenue collection: In some communities, people could and were not willing to support or pay for a water supplied.

The distance between schemes: This made it difficult for a maintenance man or unit to service the schemes regularly, or for an operator to pump water regularly, as in some divisions where one operator was responsible for a group of schemes.

A proposal was put forth by WHO sanitary Engineer Diamante in 1968 to have the company supplying the pumping equipment to the programme also to be responsible for its maintenance. Local groups were to pay premiums to the supplier towards servicing of the equipment on a regular basis. This idea was never implemented.

Conclusions and Recommendations: The WHO/UNICEF assisted demonstration rural water supplies constructed under the Environmental Sanitation Programme of the Ministry of Health had succeeded in making much of the rural population of Kenya aware of the advantages of a permanent piped water supply. Water quantity had been emphasized rather than water quality as the more important priority of the programme. The Public Health Officers were able to implement a large number of water supply projects while working within a frame that emphasized standardisation wherever possible¹⁰⁵¹.

1051 World Health Organization (1973). Sectorial Study and National Programming for Community and Rural Water Supply, Sewerage and Water Pollution Control Report No 10.: Recommendations on Administration and Organizational Structure for Water Supply Development. Brazzaville, August 1973.

Development and construction of the water supplies was given a high priority, in keeping with the government's objective of supplying adequate water for domestic and livestock consumption for the whole of the country by the turn of the century. Operation and maintenance of the supplies was not given high priority was left to the local groups or authority to carry out. Follow-ups by health officers to record the progress and condition of the projects were irregular. A special Water Supply Monthly Return Form was printed and distributed to the districts to enable records to be kept, but in some districts, these were neglected after a few months trial¹⁰⁵².

Although there were a number of government agencies dealing with community water development, co-ordination and liaison between the same was not substantial. The formation of the new Ministry of Water Development presented an opportunity for overcoming this and developing closer working relations. Ministry of Health expected after next five years of creation, its rural water supply programme would be brought up to standards set by the new Ministry. In anticipation of this, the following recommendations were made¹⁰⁵³.

Community participation was essential for the development operation and maintenance of a water supply. Education of the local community was supposed to be undertaken so that the people understand fully their responsibilities in this area. The means for achieving this was through the efforts of the Community Development Assistants (CDAs) of the Ministry of Housing and Social Services. The CDAs would operate at the grass-roots level in the rural areas. They could assist in the formation of strong local committees to oversee a water development project. It was noted in the field visits that many schemes that were operating satisfactorily were ran and maintained by a school committee, co-operative or by the efforts of a concerned person who was prominent in the community. Women benefited most directly from a piped water supply as their labour load was reduced and their spare time increased when they did not have to carry water from traditional sources to the home. Therefore, a women's group was a likely responsible organisation for raising revenue and operating and maintaining a water supply. Self-help in any form was to be encouraged.

Better co-ordination and planning between District Development Committees, Provincial Planning Offices, the Ministry of Health, Water Department and other

1052 World Health Organization (1973). Sectorial Study and National Programming for Community and Rural Water Supply, Sewerage and Water Pollution Control Report No 10.: Recommendations on Administration and Organizational Structure for Water Supply Development. Brazzaville, August 1973.

1053 World Health Organization (1973). Sectorial Study and National Programming for Community and Rural Water Supply, Sewerage and Water Pollution Control Report No 10.: Recommendations on Administration and Organizational Structure for Water Supply Development. Brazzaville, August 1973.

agencies concerned. This would aid in establishing priorities and avoiding duplication of effort. The Water Department could also assist in new site surveys and design problem solving at the district level.

Ministry of Health was required to provide the funds necessary to complete those projects which had been initiated but not finished due to insufficient local contributions. Local groups were supposed supply labour and all materials possible. Perhaps water quality improvement funds of the Ministry could be diverted to complete the supplies. All the old projects in a district were supposed to be finished before any new ones were started.

Ministry of Health was recommended to discourage attempts to develop and implement many water supplies simultaneously in any one district. For example, Kakamega District had more than ten such projects in progress at the same time. Full attention could more easily be given to two or three projects per district per year.

Schemes with mechanical pumps and engines, particularly those serving health centres, should be operated and maintained by Ministry of Health wherever they were not well-run.

County Councils were recommended to request the Ministry of Water Development to take over, operate and maintain supplies where the Councils did not have the funds.

Transportation for each District Health Officer was required to be provided. In areas where transport hire was expensive and distances between points were long, a government lorry had to be provided. Lack of transport was particularly acute in Rift Valley Province and districts where the DHO was sharing a vehicle were supposed to be given first priority during allocation.

Ministry of Health was recommended to have skilled artisans on its payroll in each district. These would be a pipe-fitter, a mason and a mechanic. They should assist in the building and maintenance of water supplies and also other construction work undertaken by the various programmes of the Ministry.

Water quality inspection and follow-up checking on the condition of all demonstration water supplies in a district was recommended to be more regular. Delegation of staff duties was supposed to be arranged so that each district had a health officer or technician doing this work on a full-time basis.

Establishment of Water laboratories in each province to facilitate analysis and quality checking was recommended.

Establishment of permanent post of the Public Health or Sanitary Engineer by the Ministry of Health. This engineer should co-ordinate Ministry of Health water development activities with the Ministry of Water Development and the engineer

should participate in the training of Health Officers and Technicians, approve designs for new water supplies and solve technical problems.

International voluntary organisations should be requested to provide engineers or technicians to work at the provincial level on the environmental sanitation programme. They also would assist in giving training in problem-solving and would supplement the staff engaged in this work.

Establishment of training programs that would emphasize practical engineering over theory. Staff evaluation should be carried out to select interested Health Officers and technicians for in-service training.

Pump attendants and operators were recommended to receive formal training at a trade school. For example, the Industrial Training Centre in Kisumu has a one-month course in plumbing that could possibly be tailored to include pump operation and maintenance as well. Standard operation and maintenance techniques should be established; the Water Department's "operator's Handbook" could provide guidelines for this.

Seminars were recommended to continue to be held on a regular basis. Provincial and District Health Officers should be asked to attend these as well as the younger, recently-graduated health officers. Problems encountered in the field should be discussed and solved.

Ministry of Health was recommended to examine similar programmes being run in other countries of the world. The WHO International Reference Centre for Community Water Supply and other organisations published newsletters and reference material.

It was recommended that the Ministry of Health forms a mobile service unit to undertake rehabilitation of out-of-order water supplies. In particular, this unit was supposed to concentrate on the large number of non-functioning hand pumps to be found along the coast and the Tana River. Local manufacturers were to be approached on developing a more sturdy hand pump than the one existing.

Generally, it was agreed that there was a need for the Ministry of Health to assume a large role in the operation and maintenance of the demonstration rural water supplies being built under the Environmental Sanitation Programme. There was also a need for further assistance on the part of UNICEF and who to protect and maintain their investment in the programme¹⁰⁵⁴.

1054 World Health Organization (1973). Sectorial Study and National Programming for Community and Rural Water Supply, Sewerage and Water Pollution Control Report No 10.: Recommendations on Administration and Organizational Structure for Water Supply Development. Brazzaville, August 1973.

Other immediate recommendations were: Technical advisers; funds to sponsor personnel for training; and donation of additional vehicles¹⁰⁵⁵.

Work accomplishment 1953: The total number of hydraulic schemes or various kinds dealt with by the DCU, including dams and waterholes built by the dam units was 808. The breakdown of the work (Table 3.58) includes: 407 in European areas and 401 in African areas. 706 were dams, 90 were waterholes and 12 were other works – rams, drainage, minor irrigation etc. 3 were for European district councils, 400 were for African district councils, 393 were for private farmers and 12 were for government establishments¹⁰⁵⁶.

Table 3.58: Total number of hydraulic schemes (dams and waterholes) built by the Dam Units

Province	District	Number of dams
Central	Kiambu	13
	Nairobi	9
	Nyeri	6
	Nanyuki	9
	Thika	11
Southern	Machakos	59
	Kitui	1
Nyanza	Central	82
	Kericho	48
	North	57
	South	161
Rift Valley	Baringo	5
	Elgeyo	6
	Laikipia	120
	Naivasha	45
	Nakuru	23
	Trans Nzoia	75
	Uasin Gishu	68
	West Suk	7
	Samburu	2
Nandi	1	

The activities of the Dam construction Units appear to have been evenly spread throughout the country and all the provinces. By February 1953, 1,265 dams, tanks and rock catchments had been constructed in Central, Rift Valley, Nyanza, Maasai,

1055 World Health Organization (1973). Sectorial Study and National Programming for Community and Rural Water Supply, Sewerage and Water Pollution Control Report No 10.: Recommendations on Administration and Organizational Structure for Water Supply Development. Brazzaville, August 1973.

1056 Annual report (1953), Soil Conservation Section and its Dam Construction Units and Contracts, Ref: RP/14/9, Kenya national archives.

Coast and the Northern provinces of Kenya. The dam construction activities went at a feverish pace within the 1950's and a lot was accomplished in the period 1950 – 1960¹⁰⁵⁷.

Water Supplies in the grazing areas

In 1940 Money allocated from the African Land Settlement and Utilisation Board section of the DARA scheme to purchase a tractor, with a mule dozer attachment, together with other related tools and equipment. A foreman was employed to supervise the undertakings of the scheme and although still in the experimental stages, development and improvement of existing water pans was carried out. The objective of the scheme was to develop such pans, excavate further pans and build earth dams on suitable sites so as to collect and store storm water for as long as possible so as to keep stock off the grazing near permanent water for as long as possible. Three pans were cleared out and enlarged in Nambala Daka, the Nambala Buyo and the Nambala Cooke¹⁰⁵⁸. In 1949 the African Land Utilisation and Settlement board appointed 1,600 pounds from DARA money to be spent in 1950 to continue the three years Water development Scheme. The Isiolo work was based on a plan of a six months working programme. Dams were built at Dibi, Kister and at Belgasa. The Kister dam it was estimated to have a capacity of 1137m³. A shallow pan was dug out between Mastasara and Kutar, while a concrete water trough and a new house for the operator at Garba Tulla water point were built¹⁰⁵⁹.

In the Northern Frontier District the problems of water supply and grazing were inseparably associated, and within 32 to 48 kilometres of all permanent watering along the Uaso Nyiro, the Tana, and Daua Rivers and around well centres such as Wajir, El Wak, Buna and Debel extensive destruction had taken place. It was suggested that the remedy to this problem lied in the provision of water supplies in areas where none existed, in order to relieve concentration round the permanent supplies and grazing management using the simple method of rotation, to distribute the stock more evenly throughout the territory¹⁰⁶⁰.

The most important permanent water supply in the region was Uaso Nyiro. It flowed from Rumuruti via Archer's Post, Herti and Sericho to Habaswein, and then it drained into the Lorian Swamp. It was reported that it waters at times

1057 Annual Report (1953), Soil Conservation Section and its Dam Construction Units and Contracts, Ref: RP/14/9, Kenya national archives.

1058 District Commissioner Isiolo (1940). Isiolo District Annual Report for the Year 1940. Kenya National Archives. DC/ISO/1/1/2, 1940.

1059 District Commissioner Isiolo (1949). Isiolo District Annual Report for the Year 1949. Kenya National Archives. DC/ISO/1/1/2, 1949.

1060 Provincial Commissioner, (1946). Annual Report Northern Frontier District, 1946. Kenya National Archives. PC/NFD/1/1/8, 1946.

supported an average of 14,000 men, women and children, 10,000 head of cattle, 8,000 camels and nearly half a million sheep and goats. It had become a subject of unfortunate controversy between the farmers on the catchment area who used its water for irrigation purposes, and Government which restricted such irrigation, in the dry season, when sufficient water was not flowing into the Northern Frontier District to fulfil the requirements of the people. In 19th October the Governor met a delegation representing the farmers' Associations in the Uaso Nyiro drainage area at Nanyuki. They presented a petition to him and the governor informed them that the Government would investigate means of increasing and controlling the flow of the river in the upper ridges. In addition, the Water Resources Board and Catchment Area Board would replace the existing Water Board and the Dr Dixey's scheme would be implemented. However, he insisted that the arrangement whereby 42½ cusecs had to flow at all times under the Archer's Post Bridge was to stand, even if it necessitated a restriction on irrigation by farmers¹⁰⁶¹.

As a measure of water supplies and grazing control, it was recommended to break the original District schemes into two parts; the first one was to cover the operation and maintenance of the Grazing Control Organisation, and the second one to provide for the development of existing water supplies. The intention was to create a Grazing Guards' organisation, to oversee the pasture control measures. It was hoped that within five years sufficient additional revenue would have been raised in the Province to offset the cost of the organisation. However, it was believed tribesmen would have to be persuaded to agree to pay an increased Poll Tax rate unless a start was made on the Dixey schemes¹⁰⁶².

The water schemes were aimed at developing the existing water supplies over a period of three years. This was through maintaining and improving the existing pans, reconstruction of disused pans, and constructing of new pans and tanks in suitable areas. The schemes were closely linked with the District Grazing Control measures and it was anticipated they could result not only in a better distribution of minor temporary supplies but also in the establishment of a number of major temporary supplies on the lines of the large tanks constructed at Ijara¹⁰⁶³.

Concerning the water supplies in the Province it was generally commented that with exception of Garissa the water supplies were either inadequate in quantity or

1061 Provincial Commissioner, (1946). Annual Report Northern Frontier District, 1946. Kenya National Archives. PC/NFD/1/1/8, 1946.

1062 Provincial Commissioner, (1949). Northern Province, Annual Report, 1949. Kenya National Archives. PC/NFD/1/1/8, 1949,

1063 Provincial Commissioner, (1949). Northern Province, Annual Report, 1949. Kenya National Archives. PC/NFD/1/1/8, 1949,

highly mineralised in quality, as for Lokitaung it was both. 1,000 pounds was spent in carting water to the stations from wells and boreholes¹⁰⁶⁴.

In 1943, the Northern Province was surveyed by Dr Dixey and Mr Edwards, the senior pasture research officers and they concluded that lack of adequate water supply made it impossible for proper distribution of livestock. This caused overstocking in the areas around the main sources of water. The only remedies was a plan for improved water supplies coupled with adequate measures for grazing, and moving the tribesmen from the permanent watering centres and complete protection of the neighbouring pastures during the rains¹⁰⁶⁵.

Thus the Dixey's scheme was approved in principle and a grant of 485,000 pounds was made from the Colonial Development and Welfare Fund for the development of water supplies in the Northern Province and Samburu. However, because of the war it was impossible for the Government to undertake the work and instead they appointed consulting engineers, Messrs Howard Humphries, who commenced their preliminary investigations during 1950. The consulting engineers estimated that the boreholes would cost between 3,500 pounds and 10,000 per unit designed to provide a total yield of 45.5 m³ per day. They also reported that the annual cost of maintaining a borehole in Northern Province conditions was between 200 and 300 pounds. They further reported that assuming a borehole would be in use for seven or eight months per year, then the cost of water was expected to be between KES 6 and KES 8 per 1000 gallons¹⁰⁶⁶.

The revised water estimates costs were real but purely on economic grounds provision of addition water supplies could not be considered. The boreholes were required to open up additional grazing areas to hard pressed tribesmen and to enable sound measures of grazing control to be established. Thus it was decided that the first ten boreholes should be sunk in Samburu District early 1951, and depending on the achieved results they were to be followed by a pilot scheme of 28 boreholes in the Northern Frontier and 12 boreholes in Turkana¹⁰⁶⁷.

In the same year the District Commissioners carried out pasture surveys and prepared measures for grazing control based on the boreholes to be sunk as proposed in the pilot scheme of each District. The measures would vary depending on whether the area provisionally selected for the borehole was deemed suitable by the

1064 Provincial Commissioner, (1949). Northern Province, Annual Report, 1949. Kenya National Archives. PC/NFD/1/1/8, 1949,

1065 Provincial Commissioner, (1950). Northern Province, Annual Report, 1950. Kenya National Archives. PC/NFD/1/1/8, 1950,

1066 Provincial Commissioner, (1950). Northern Province, Annual Report, 1950. Kenya National Archives. PC/NFD/1/1/8, 1950,

1067 Provincial Commissioner, (1950). Northern Province, Annual Report, 1950. Kenya National Archives. PC/NFD/1/1/8, 1950,

Consulting Engineers. Meanwhile the administration had been pressing to go on with the development of temporary water supplies¹⁰⁶⁸.

In 1956, the District Commissioner initiative resulted in a highly successful scheme by which waters from the Songa Gambela forest were piped down to the grazing areas. The project was financed from the Special Districts (Administration) Ordinance Fund. It involved laying down of 7,000ft of piping, construction of a concrete take-off sump and the erection of a 91m³ Braithwaite storage tank. At the height of the drought the estimated flow was 6.8m³ per hour and an estimated total of 2,000 head of cattle used this source daily¹⁰⁶⁹.

Operation and maintenance: Water department schemes were well run and maintained. Operational problems from these schemes stemmed from the continual running of schemes at or near maximum capacity. According to WHO report, 1971, some 25% of gazetted schemes required augmentation. County Council schemes, Land and Settlement schemes had major operation and maintenance problems. For example 51% of WHO/UNICEF assisted schemes in the 1963 to 1970 programme were not working. Also, a higher proportion of pump schemes compared to gravity schemes were not working¹⁰⁷⁰.

The basic problem with rural water supplies was that they were small and could not afford a sufficient standard of skilled staff, equipment and transport facilities. Repair and fuel supplies to isolated areas were expensive and difficult to organise. The three main constraints in the area of water development in Kenya were financial limitations, staff shortages and deficient administrative procedures as per WHO report, 1971¹⁰⁷¹.

3.5.2 Kenya-Finland Western Water Supply Program

Kenya was one the main recipients of the Finnish bilateral assistance within the Official Development Cooperation of Finnish Government. The Finnish development co-operation started in the late 1960's when Finland joined other Nordic countries in supporting the co-operative movement in Kenya. In the 1970's, Finland granted

1068 Provincial Commissioner, (1950). Northern Province, Annual Report, 1950. Kenya National Archives. PC/NFD/1/1/8, 1950.

1069 Kennaway N E, (1956). Northern Province Annual Report: 1955. Kenya National Archives. PC/NFD/1/1/11, 5th, April 1956.

1070 World Health Organization (1971). Sectoral Study and National Programming for Community and Rural Water Supply Sewerage and Water Pollution Control. Report No 1. General Community Water Supply Problems. Brazzaville.

1071 World Health Organization (1971). Sectoral Study and National Programming for Community and Rural Water Supply Sewerage and Water Pollution Control. Report No 1. General Community Water Supply Problems. Brazzaville.

Kenya three development credits that were converted into grants in 1979, and thus Kenya became a programme country in 1980. The general objective of Finnish aid was to contribute to Kenya's efforts towards economic and social development and self-reliance. The rural population was a special target group for Finnish aid and it concentrated on five major sectors identified on the basis of Kenyan priorities and the resources available in Finland. These were agriculture and livestock, water supply, health, forestry and energy.

The rural water development project in Western province was initiated in early 1981. Between 1982 and 1983, investigations and planning were carried out. The agreement on the first implementation phase of the project was made in November 1983. Joint Venture Kefinco was awarded the execution of the project implementation of Phases I to IV, whereas Plancenter was involved in the community water supply management project. The scope of service, including construction, was defined based on the implementation plan presented in the water supply development plan, which was expected to run until 2005 (from June 1983). After Phase III, (a bridging-over phase) the main emphasis was to maintain continuity in activities between the third and fourth phases. The overall objectives of Phase IV was to support the Kenya Government's efforts to provide the population with a safe and adequate supply of potable water for better health, improved standard of living, and better economic opportunities.

During the earlier phases up to 1993, the supply-driven approach (SDA) development strategy was applied with high construction targets that left little opportunity for community involvement. The SDA was found to be non-viable, and thus the mid-term review for Phase III recommended a demand-driven approach (DDA) which would lead to a choice of technology and/or level of service reflecting the wishes and long-term organisational, management and financial strengths of the community. Thus, the fourth phase adopted a demand-driven approach (DDA). Towards the end of the KFWWSP there was increasing concern over the sustainability of the results, as the responsible ministry and the consumer community did not have the needed capacity to develop and maintain water resources and facilities.

The community water supply management project (CWSMP) spanned from January 1997 to June 1999 to sustain the achievements of the completed KFWWSP. CWSMP was to support the Government policy direction, and thus adopted the demand-responsive approach (DRA) that emphasised the communities' own initiative and commitment to contribute, to own, improve and replicate facilities put in place. CWSMP closed the activities in mid-2003.

The need for a water project was justifiable since it improved the health and living standards of the users through provision of safe water. This called for health

education as an integral component of the water supply. It was on this basis that the primary healthcare programme in Western province was set up. The origin of the primary healthcare programme dated back to the 1978 signing of the Alma Ata declaration of health for all by the year 2000, using primary healthcare as a strategy. Kenya, which was a signatory to this declaration, started searching for a partner to implement this strategy. The Finnish Government responded to this need as part of the existing agreement with the Kenya Government on implementation of the water project in Western province. Western province was a suitable site for the primary health care initiative because it was poor, densely populated and had a very high incidence of diarrhoeal diseases and worm infestation. The province also lacked access to health facilities and sufficient sanitation coverage. There were plans in place for new cooperation in water sector between the two governments¹⁰⁷².

From the late 1960s through the mid-1980s, a large number of water sector specialists were assigned to work in Kenya. The main field of their work was in sector policy and strategy development, and assistance in the identification and preparation of new projects. This was important for many of the Rural Water Supplies (RWS) projects that were later to be included in the DIDC programme. Later on, during project implementation, these Technical Assistance (TA) specialists provided invaluable support in the international support to develop the new water sector policy, issued in 1999. The implementation strategy of the policy was tested and the DIDC project in the Western Provinces provided a useful feedback from a real life operation¹⁰⁷³.

The TA- specialists made an important contribution to the capacity building of the water sector in the country through on-the-job training of local staff at the same time Finnish water specialists obtain valuable international experience while working in their TA-assignments¹⁰⁷⁴.

The TA-specialists, especially those who had worked in Kenya and Tanzania, identified the need for postgraduate (PG) training of water professionals. The DIDC (then FINNIDA) agreed to fund the training courses, and the first PG-course was

1072 Skyttä, T. K., Ojanpera, S. and Mutero, J (2001). Evaluation of Sector Performance. Report of Evaluation Study. Finland's Support to Water Supply and Sanitation 1968-2000. Unit for Evaluation and Internal Auditing, Ministry of Foreign Affairs, Department of International Development Cooperation. Helsinki, Finland. April 2001.

1073 Skyttä, T. K., Ojanpera, S. and Mutero, J (2001). Evaluation of Sector Performance. Report of Evaluation Study. Finland's Support to Water Supply and Sanitation 1968-2000. Unit for Evaluation and Internal Auditing, Ministry of Foreign Affairs, Department of International Development Cooperation. Helsinki, Finland. April 2001.

1074 Skyttä, T. K., Ojanpera, S. and Mutero, J (2001). Evaluation of Sector Performance. Report of Evaluation Study. Finland's Support to Water Supply and Sanitation 1968-2000. Unit for Evaluation and Internal Auditing, Ministry of Foreign Affairs, Department of International Development Cooperation. Helsinki, Finland. April 2001.

organized in 1972. After a pause of nearly ten years, the PG-programme was reactivated and the courses continued through 1992¹⁰⁷⁵.

The total number of students was over 100, coming mainly from Ethiopia, Kenya, Tanzania and Zambia. In brief, most of the graduates of the PG-programme occupied responsible positions in the water sector organisations in their countries and made an impact on the overall sector development¹⁰⁷⁶.

There were no studies carried out on the long-term development of WSS services in Kenya, although the first projects dated back to the pre-colonial period of the 1800s. There were a lot of development projects over the years – this accumulated knowledge was supposed to be collected and analysed.

In several occasions, it was noted that in providing and producing operative water and sanitation services institutional and management issues together with proper policy environment were the most challenging areas. Research based and analysed historical knowledge was of outmost importance for understanding and development such institutional frameworks. All in all, the suggested study had a very high social relevance. Development of WSS services was generally accepted as one of the cornerstones in poverty eradication.

Water quality analysis: In Finnish assisted projects, laboratory examinations of water were probably most frequent undertaken to aid in the forming of an opinion of suitability of water supply for public use. Whether water was safe for human consumption was shown by; presence or absence of pollution, whether it was corrosive to metal pipes, or whether it formed scale on cold or hot water systems, and whether it was attractive in appearance and taste. Regular laboratory analyses were recommended for control of effluent at all times. Turbidity, colour, odour, pH Value, jar test, and residual determination were all carried out to determine the quality of water supplied¹⁰⁷⁷.

1075 Skyttä, T. K., Ojanpera, S. and Mutero, J (2001). Evaluation of Sector Performance. Report of Evaluation Study. Finland's Support to Water Supply and Sanitation 1968-2000. Unit for Evaluation and Internal Auditing. Ministry of Foreign Affairs, Department of International Development Cooperation. Helsinki, Finland. April 2001.

1076 Skyttä, T. K., Ojanpera, S. and Mutero, J (2001). Evaluation of Sector Performance. Report of Evaluation Study. Finland's Support to Water Supply and Sanitation 1968-2000. Unit for Evaluation and Internal Auditing. Ministry of Foreign Affairs, Department of International Development Cooperation. Helsinki, Finland. April 2001.

1077 Ministry of Water Development, Kenya and Ministry of Foreign Affairs, Finland (1992). Kenya-Finland Western Water Supply Programme: Operation and maintenance Manual-Kaimosi Water Supply.

3.5.3 Rural Domestic Water Supply and Sanitation Programme

In the late 1960s, the government of Kenya approached possible sponsors with the view to funding a rural water supply programme. The programme had two major aims. The first aim was to break water related development bottlenecks in the high potential areas and the second to provide portable water in areas of chronic drought. SIDA showed interest in funding this programme and the first of three credit agreements signed between the Governments of Kenya and Sweden was in 1970. Subsequently two more agreements were signed in 1972 and 1974 respectively. The third agreement ran up to 1978. A fourth phase of the programme had been prepared by 1976 and donors were being sought.

Prior to 1976, water development was seen primarily an engineering activity. This perspective viewed performance as either a success or a failure. VIAK EA LTD, the consultancy company regarded this view as naïve for such complex social amenity as water supply scheme¹⁰⁷⁸.

Numerous aspects of a scheme required assessment and multiple criteria were relevant for most aspects. Evaluation tended to concentrate upon examples of failure, mainly because these were easier to identify and measure. The company observed that more sensitive approach was essential and evaluated rural water supply programme objectively and constructively.

By 1976, Kenya's application to the problem of providing rural people with portable water was first in Africa. Any form of rural development faced unique and therefore unforeseen problems. The outcome of Kenya's efforts compared very favourably with neighbouring conditions. However, Kenya demonstrated a willingness to adjust the policy, pace and form of rural water development in line with experience. The need for community water supply was widely appreciated and the financial and manpower resource requirement were getting evident¹⁰⁷⁹.

Rural water development received substantial public resource allocations between 1968 and 1976, largely on the basis of it being a productive input into the agricultural sector. The water revenue performance indicated that without reform, government's financial obligation was greater than in the previously optimistic revenue forecast. There was little doubt that with amelioration, rural water schemes could be made to function efficiently and give considerable social benefits to the consumers. One

1078 Ministry of Water Development, Kenya and Ministry of Foreign Affairs, Finland (1992). Kenya -Finland Western Water Supply Programme: Operation and maintenance Manual-Kaimosi Water Supply.

1079 Ministry of Water Development, Kenya and Ministry of Foreign Affairs, Finland (1992). Kenya -Finland Western Water Supply Programme: Operation and maintenance Manual-Kaimosi Water Supply.

and half million rural inhabitants with access to rural water represented considerable opportunity for the ministries of health and agriculture.

Approximately, 13% of the rural population had access to improved water supply. Several agencies were involved in rural water. The RWS programme served 40% of these people who had access to the improved water. However, this programme was only one of the activities of MWD which also included Minor Urban Water Supply Programme, sewerage schemes, water pollution control, and range and ranch water programmes. Other agencies were active in the rural water field, these were, the ministry of lands and settlement, UNICEF, County Councils and self-help organisations.

The field work involved technical on-site evaluation of 35 completed schemes and five that were under construction. The evaluation objectives were: (a) to assess the operating efficiency of completed schemes, (b) to provide feedback to planners on the validity of the original planning assumptions, (c) to provide feedback on appropriateness of existing means of water development in light of the government objectives, (d) to justify the efforts being made with a view of attracting resources and stimulating further investment and (e) to indicate areas where complementary inputs could improve the overall efficiency and effectiveness of rural water investments

In evaluation of performance of these schemes, three main criteria were developed relating to the water quality, reliability and use. Water quality regarding physical, chemical and bacteriological quality had to satisfy the WHO international standards, interruptions in supply of water lasting for less than two consecutive days were regarded as acceptable if the interruptions were not regular. A scheme was considered successful if the actual consumers were more than fifty percent of the potential consumers. The consultants established that 55% of the potential customers were actually using the supplies. However, on high potential areas, actual usage was higher, reaching over 90%. The proportion of the actual consumers was expected to increase. 47% of the actual consumers were provided with a reliable water supply, 26% of the potential customers¹⁰⁸⁰.

Scheme selection: The criteria of breaking the bottlenecks and providing water in areas of chronic drought were used by the district development committees to operate on effective selection procedure incorporating local requirements and aspirations. Although there were some discrepancies in the RWS capital allocation to districts,

1080 Ministry of Water Development, Kenya and Ministry of Foreign Affairs, Finland (1992). Kenya -Finland Western Water Supply Programme: Operation and maintenance Manual-Kaimosi Water Supply.

these were manifestly unimportant. The selection procedure worked and there was evidently little animosity in rural areas over the distribution of water supplies.

Planning and design: Scheme design was sometimes based on inadequate hydrological data. As a result source yields were occasionally insufficient at certain times of the year. More comprehensive hydrological investigations were sometimes required and regular ganging of sources had to be carried out during scheme operation. In many planning documents a casual approach of demand forecasting was noted. The existing MWD guidelines were adequate. However, it was recommended that the concept of maximum land carrying capacity be abandoned as being unrealistically rigid in time of rapid rural change¹⁰⁸¹.

Over 60% of the schemes used surface water sources. This had an important implication for treatment policy. There was no major defect in the design of the scheme treatment works and in general they operated satisfactorily because the government's intention to provide water to WHO standards and because of the cholera risk, an extended programme of treatment was recommended. Most schemes were pumped and were less reliable than gravity schemes because of adequate standing capacity. It was evident that the MWD had to rely on consultants and contractors for large schemes in the then foreseeable future, particularly if the construction programme was to be expanded.

Operation and maintenance: The workload of the operation and maintenance branch of MoWD was increasing at an accelerating rate while the source (technical staff, facilities, stores and workshops) per consumer were diminishing. Although the annual recurrent budget was increasing and had run at about 8% of the development budget for several years prior to 1976, it diminished in real terms and by 1976 represented less than two percent of the existing value of accumulated capital assets. Manpower, transport, technical support, training and management systems were also deficient. O&M inherited many of the faults in planning and design. In addition, procedures for commissioning and correcting initial operating deficiencies were inadequate¹⁰⁸².

Water sales and pricing policies: If the rate of investment was maintained, the financial burden on the government could be eased by effective revenue policies, the consultants observed. On the other hand, if the rate of investment was improved in

1081 Ministry of Water Development, Kenya and Ministry of Foreign Affairs, Finland (1992). Kenya-Finland Western Water Supply Programme: Operation and maintenance Manual-Kaimosi Water Supply.

1082 Ministry of Water Development, Kenya and Ministry of Foreign Affairs, Finland (1992). Kenya-Finland Western Water Supply Programme: Operation and maintenance Manual-Kaimosi Water Supply.

line with the plans, external aid sources were necessary and it was likely that sound revenue practice had to be demonstrated as a precondition for aid. The consultants deemed the existing policy sound and recommended MoWD to take over the policy administration in terms of accounting and the responsibility for collection on the larger schemes. There was ability and readiness to pay for water in rural areas and it was feasible to collect sufficient revenue to cover the operation and maintenance costs of the whole rural programme. However, for this to work effectively, the rates were supposed to be increased by 33%.

The consultants observed that if Aid flows continued and if revenue performance improved the existing policy of individual connections where possible was supposed to continue. However, if aid flow diminished, the policy was supposed to be reconsidered¹⁰⁸³.

Socio-economic benefit: The benefits of improved water supply included the following: livestock watering, crop spraying, seedbed watering and encouragement of settlement in drier parts of the medium and high potential areas. In addition, the RWS programme had potential for impact on several major water related diseases which accounted for nearly 90% of faecal oral diseases in Kenya.

Hindrances: Vandalism was experienced on almost all schemes, issues such as wilful damage; theft, technical interference, frustration and the like were reported. However, the consultants observed that such could be reduced significantly by sound planning including accurate information to potential consumers, reliable scheme operation and prosecution of offenders¹⁰⁸⁴.

The causes of programme delay fell into two categories, exogenous (outside the government) and endogenous (under government control). The exogenous factors include late delivery of materials, world shortages of materials and weather problems. Endogenous on the other hand include cumbersome and inefficient tendering and accounting procedures, import restrictions, deficient administrative procedures and inadequate staff. It was evident that bulk of shortcomings were endogenous and therefore under the control of the government. The consultants considered that under the existing conditions, the cost increases were less than what was expected and therefore the MWD was able to exercise sufficient control to minimize inflationary effects on programme costs. The construction of large structures such as treatment works in rural areas had many logistical difficulties. Although, the readily available

1083 Ministry of Water Development, Kenya and Ministry of Foreign Affairs, Finland (1992). Kenya-Finland Western Water Supply Programme: Operation and maintenance Manual-Kaimosi Water Supply.

1084 Ministry of Water Development, Kenya and Ministry of Foreign Affairs, Finland (1992). Kenya-Finland Western Water Supply Programme: Operation and maintenance Manual-Kaimosi Water Supply.

labour aided construction, the problems in delivery of materials sometimes delayed completion. Figure 3.66 is an illustration of a treatment plant construction works¹⁰⁸⁵.



Figure 3.56: The construction of treatment works

The provision of improved water supplies to rural areas of Kenya (in common with much of the rest of Africa) encountered a problem not experienced in other parts of developing world. The rural population was widely scattered on individual farm plots and did not live in villages as in case of Asia and South America where much experience of rural water supply had been gained. Thus many schemes covered large areas in order to serve widely dispersed population¹⁰⁸⁶.

The consultants established that redefinition of development priorities after initial selection was the cause of several of the changes thus affecting the scheme selection procedures.

When RWS I agreement was signed, the supplies for North Eastern and some parts of Eastern and Rift Valley Provinces were not identified. It was not until several years later that they were selected. In their initial selections the District Development Committees did not consider the static population both within and without the

1085 Ministry of Water Development, Kenya and Ministry of Foreign Affairs, Finland (1992). Kenya-Finland Western Water Supply Programme: Operation and maintenance Manual-Kaimosi Water Supply.

1086 Ministry of Water Development, Kenya and Ministry of Foreign Affairs, Finland (1992). Kenya-Finland Western Water Supply Programme: Operation and maintenance Manual-Kaimosi Water Supply.

area. The MWD rejected the selection. In the second attempt the DDC covered several projects to be taken over by the Range water programme. Several more areas selected were rejected due to lack of suitable water source¹⁰⁸⁷.

In some large schemes due to unavailability of funds, only the bulk lines were constructed with the main distribution lines installed much later. The time lag was more than five years. Such time lag between scheme design and the start of operation resulted in a substantially reduced effective usage period.

Feasibility of the National Target: Although it was evident that MoWD's implementation capacity was increasing in seventies, further large increases were required in order to reach the government target of serving the whole rural population by the year 2000. The target was reachable only if expenditure capacity was increased by 59% every five years from 1985. An evaluation carried out is illustrated in table 3.59. There was a tremendous scope for the expansion of the MoWD's involvement in self-help which assisted the rate of progress of the target. However, the achievement was faced with major constraints similar to those identified in 1973 WHO sectorial study which included:

- MoWD did not control its own accounting and that was a source of delay and confusion.
- Recurrent funds were apparently inadequate.
- Revenue policy and execution was deficient.
- Office accommodation was cramped and unstable.
- The supply of Kenyan engineers was inadequate.
- Expatriate engineers were not being recruited to accommodate the expanding workload.
- The existing geographical split in the top management of the water sector coupled with some areas of overlapping responsibility, it was not conducive to efficient performance.
- Liaison between different levels of MWD staff was inadequate.
- The provincial and district organisations were deficient, needed strengthening, expansion and focus on rehabilitation, operations and maintenance.
- Marketing services section was backed up by applied research.
- Secretarial services were deficient¹⁰⁸⁸.

1087 Ministry of Water Development, Kenya and Ministry of Foreign Affairs, Finland (1992). Kenya -Finland Western Water Supply Programme: Operation and maintenance Manual-Kaimosi Water Supply.

1088 Ministry of Water Development, Kenya and Ministry of Foreign Affairs, Finland (1992). Kenya -Finland Western Water Supply Programme: Operation and maintenance Manual-Kaimosi Water Supply.

Table 3.59: Water supply schemes evaluated

Scheme	Province	District	Year completed
RWS I			
Gatangu Ngecha	Central	Kiambu	1973
Inoi	Central	Kirinyaga	1972
Tezo Roka	Coast	Kilifi	1972
Mkowe	Coast	Lamu	1972
Garsen	Coast	Tana River	1972
Kyeni	Eastern	Embu	1972
Mtitu Mui	Eastern	Kitui	1971
Mbumbuni	Eastern	Machakos	1971
Siathani	Eastern	Machakos	1972
Log Loggo	Eastern	Marsabit	1971
Kabartoyo	Rift Valley	Baringo	1971
Torongu	Rift Valley	Baringo	1975
Lamek	Rift Valley	Narok	1972
Busia Hills	Western	Busia	1971
RWSI: Phase II in RWS II			
Tetu Thgenge1	Central	Nyeri	1973
Kikoneni	Coast	Kwale	1974
Keroka 1	Nyanza	Kisii	1974
Mauna Dam1	Nyanza	Siaya	1973
Uyoma1	Nyanza	Siaya	1973
W. Karachuoyo	Nyanza	South Nyanza	1973
Chepalungu	Rift Valley	Kericho	1973
Ndivisi	Western	Bungoma	1973
Mbale 1	Western	Kakamega	1971
RWS II			
Karingani	Eastern	Meru	Under construction
Tigania	Eastern	Meru	Under construction
Nyamira	Nyanza	Kisii	Under construction
Sameta	Nyanza	Kisii	Under construction
Oyugis	Nyanza	South Nyanza	Under construction

Access to an improved water supply: The 1974-78 Development Plan estimated that in 1972, about 930,000 people had access to an improved water supply. This included the population in the low potential areas living within 4 kilometres of an improved water source. The consultants estimated that in 1976, 1.5million rural people had access to improved water supply. That represented 13% of the rural population (figure 3.57). The RWS Programme supplied about 40% of the rural population, which had access to improved water. However, there was a dearth of accurate information on the numbers of the rural people served by the various agencies working for the water sector in Kenya¹⁰⁸⁹.

1089 Ministry of Water Development, Kenya and Ministry of Foreign Affairs, Finland (1992). Kenya -Finland Western Water Supply Programme: Operation and maintenance Manual-Kaimosi Water Supply.



Figure 3.57: Rural population with access to an improved water supply by 1976

Various projects in various rural water supply programmes in 1977 are illustrated in Figure 3.68¹⁰⁹⁰.

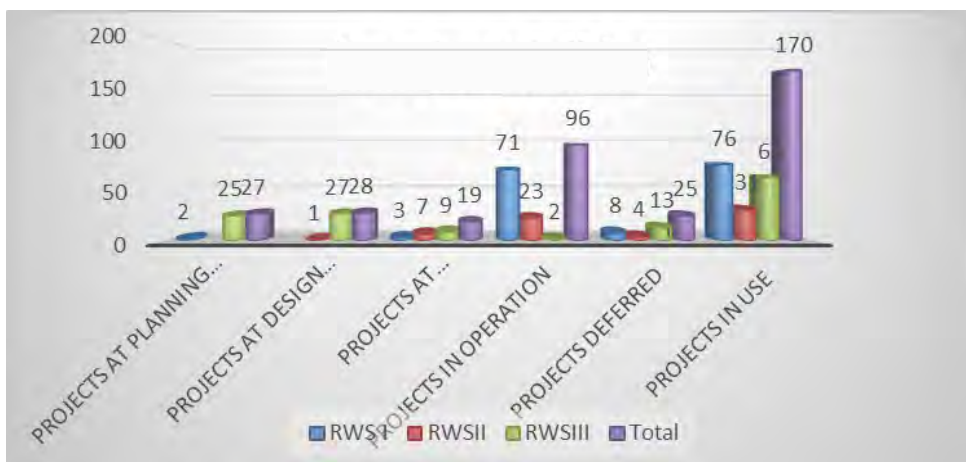

Figure 3.58: Stages of various projects in various rural water supply programmes by 1977

Other water Investments: By 1976, many water supplies were constructed in rural areas independently of SIDA programme. Within the MWD alone there were; range

¹⁰⁹⁰ Ministry of Water Development, Kenya and Ministry of Foreign Affairs, Finland (1992). Kenya -Finland Western Water Supply Programme: Operation and maintenance Manual-Kaimosi Water Supply.

and Ranch water programmes in North eastern, Coast, Eastern and Rift Valley Provinces providing water to nomads and their cattle, self-help schemes were evident in many parts of the country. The ministry of agriculture also had a livestock water programme. However, these investments concentrated in areas where there was underinvestment in RWS (figure 3.59) programme to minimize the discrepancies.

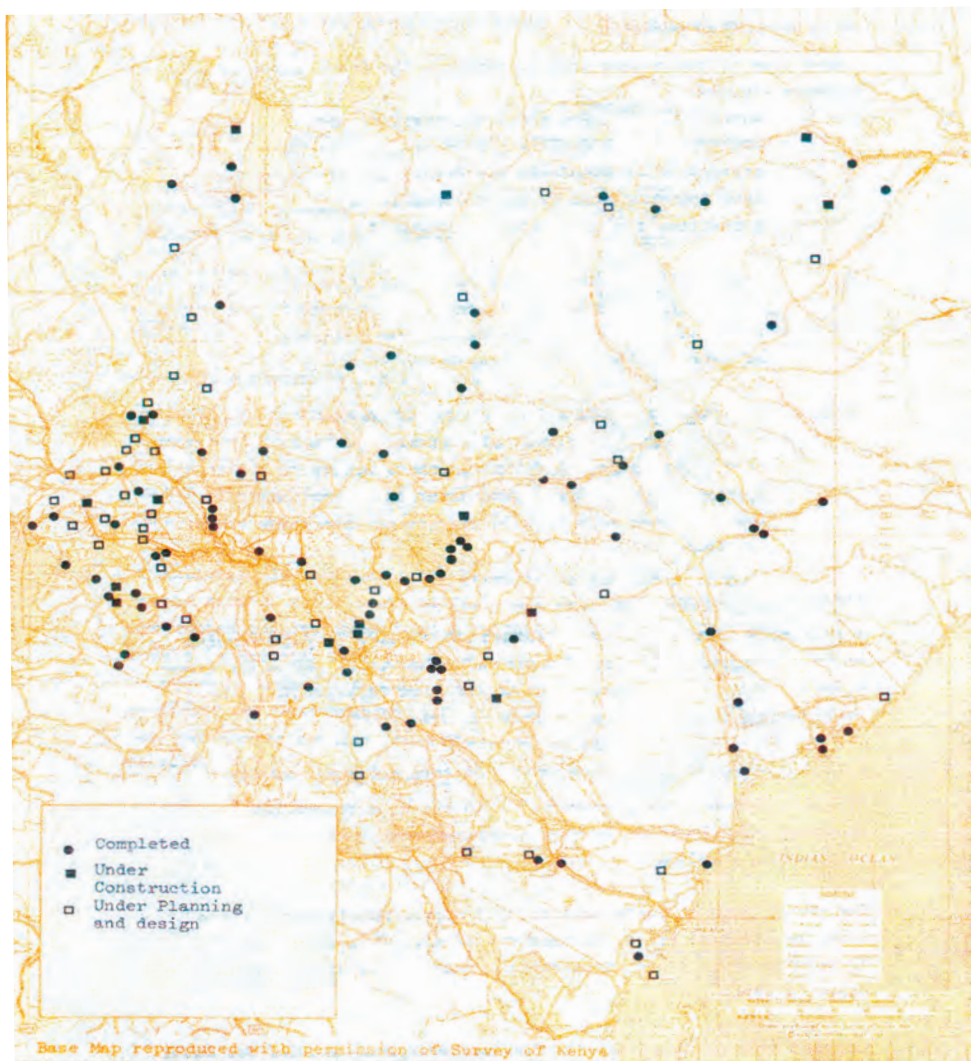

Figure 3.59: The distribution of Rural Water Supply Schemes as at June 1977¹⁰⁹¹

1091 Ministry of Water Development, Kenya and Ministry of Foreign Affairs, Finland (1992). Kenya -Finland Western Water Supply Programme: Operation and maintenance Manual-Kaimosi Water Supply.

3.6 Donor Interest

Donor interest divided itself into four categories and the response to water use problems depended largely in which category the donor placed himself. The first category of donors supported development of engineered water schemes. The group felt that construction of more schemes was the major objective of assistance. Such donors felt that the projects had to be financially viable. The second category saw water as an acute and urgent need and that human beings have an inherent right to a clean water supply. The proponents were very worried about a tariff system that would cut off a large share of the potential customers. Third category believed that only appropriate technology low cost projects had any responsibility of succeeding in providing water to rural areas. Such donors were really only willing to support such projects. Finally, some donors had the view that development means manpower development and good public administration rather than construction of schemes. For these donors the essential point of water use policy was to identify a sound policy and administer it properly. They would argue that the content of the policy was important, but still secondary as it was impossible to predict what would happen within the administrative system¹⁰⁹².

3.6.1 Dutch Support

By 1976, the Netherlands had several projects in central Kenya. The Dutch agreed to support Ndia division, Komothai and Sigor Longisa water schemes. The cooperation between the Kenya government and the Netherlands government was such that Kenya could always add on projects that would receive funding whenever it was available¹⁰⁹³.

3.6.2 Norwegian Support

Norwegian involvement in the water sector began in 1966 in the form of technical assistance. The main objective of the Minor Urban Water Supply Programme (MUWSP) was providing water supply, sewerage and sanitation facilities for minor urban communities throughout Kenya. The overall plan of implementation for the

1092 MOWD (1983). Water Use Study; Draft Report, Nairobi, Kenya.

1093 Muguro W.M. (1976). Rural Water Programme Phase II-Netherlands Component. Kenya National Archives, WD/1/2/24. Ref: DV/87/78/01. 23rd June 1976.

program was officially presented to NORAD in 1973. The first formal agreement for Minor Urban Water Supply programme was signed in 1974. The intention was to construct approximately 40 water supply and 7 sewerage schemes with 50% NORAD financing in selected minor urban centres in Kenya¹⁰⁹⁴.

The cost estimated was KES 90 million for the project to be completed within five years in 1978. In order to develop the integrated implementation strategy, MoWD proposed allocation of specific support to MoWD for water supply activities, to MOLG for sewerage construction and MOH for environmental sanitation/health education¹⁰⁹⁵.

The minor urban water supply programme received Norwegian assistance from 1974 with the objective of providing water supply and sewerage/sanitation facilities for minor urban centres and growth centres. The Ministry of Water Development administered and implemented the programme on behalf of the government of Kenya. The follow-up responsibility on the Norwegian side was delegated to NORAD's Resident Representative in Kenya.

Over the years, and particularly from 1980 onwards, it became increasingly difficult for Kenya to meet her financial obligations. This was partly due to a high inflation rate of 437% within a period of ten years and extension of works more than originally intended. Inflation and the extension of initial schemes (inclusion of surrounding rural population) led to a major price escalation. The price rose to KES 1,151 million for water supply schemes and KES 145 million for sewerage schemes (Total KES 1296 million). This problem combined with substantial overruns and inefficient management brought the programme progress almost to a halt.

The review of the programme in 1981/82 indicated serious deficiencies in technical progress, high costs, poor water service coverage, social inequalities, inadequate reliability, uncoordinated water/sewerage/sanitation/health measures and inefficient use of NORAD's technical assistance inputs. These findings resulted in a revision of the agreement with more NORAD control, 100% financing, direct purchases, reduced scope, and specific use of NORAD expatriates in MoWD¹⁰⁹⁶.

In 1983, the negotiation between the two parties led to 100% Norwegian financing. This also brought about procedures of direct payments by NORAD to alleviate bottlenecks identified in the programme execution. In 1988, the major

1094 Norconsult A.S. (1988). Development of an Integrated Physical/Financial/Socio-Economic Monitoring and Evaluation Programme for Water Supply Schemes, Draft Final Report, Report No. (. Ministry of Water Development, Republic of Kenya.

1095 HIFAB International (1988). Report of Appraisal Mission: Minor Urban Water Supply Programme 1988-1992, Proposed by the Ministry of Water Development, Kenya in March 1988. Ministry of Development Cooperation (NORAD) April 1988.

1096 Norconsult A.S (1988). Development of an Integrated Physical/Financial/Socio-Economic Monitoring and Evaluation Programme for Water Supply Schemes, Draft Final Report, Report No. 9. Ministry of Water Development, Republic of Kenya.

emphasis was rehabilitation and augmentation of projects constructed in the initial phase, support to operation and maintenance, support to standardisation and applied research activities, training and technical assistance.

3.6.3 Canadian Support

In July 1979, the ministry of water proposed several projects for the CIDA team to undertake in western Province and some in the neighbouring districts of the Rift Valley province. The proposed projects were¹⁰⁹⁷:

- North Mugirango in Kisii district
- Alego in Siaya district
- Kimologit in Kericho district
- Namasanda in Bungoma district
- Kipsigak/Kablamai/Mesioo in Nandi district
- Keese in Transzoia district
- Olihundo in Narok district

In 1979, the director for water resources informed the Permanent Secretary, in the ministry of water development to initiate dialogue with Canadians to enable the ministry put across a case for a second agreement to cover construction costs estimated at 500 million Kenya shillings. By 1983, the Canadian government through CIDA had provided 5,350 Kenyan pounds in assistance to the Kenya rural water supplies

3.6.4 Swedish Support

Initially water supply in Kenya concentrated in urban centres and scattered settlement schemes. Concerted efforts from the government in national master plan and international development partners spearheaded the initiative to provide water in the rural areas¹⁰⁹⁸.

SIDA led other international agencies through initiating own projects and providing technical and financial support to the existing projects/schemes. Principally, it helped rehabilitate the western province rural water supplies and assisted KWAHO

¹⁰⁹⁷ Mutito (1979).

¹⁰⁹⁸ Baker D (1978). Programmes (Exc. Settlement Water Supplies) 1978/79 to 1982/1983) Kenya National Archives, RP/9/6. Ref: WD/2/1/37, 22nd January 1978.

in community mobilisation to develop own projects. Above all, SIDA contribution was felt in every province. SIDA and World Bank contributed financially to this end whereas the EEC organized several micro projects through systematic tranche in annual programmes¹⁰⁹⁹

The government of Sweden continuously supported the water sector in Kenya since 1970. Support in 1970s was directed towards construction of large piped rural water schemes. In 1980s, support focused mainly on operational and maintenance, training and rehabilitation of existing water supplies to bring them back to original design standards. At the same time, similar and more affordable technologies were being tried and tested on pilot basis. The Kwale Water and Sanitation Project (1985-1997) was a success in that it brought the community into focus and resulted into actual integration of water and sanitation technology software. The lessons from Kwale were adopted in Tharaka Water and Sanitation project (1988-1999) and the integration of the work of engineers, drillers, public health officers and sociologist was further refined¹¹⁰⁰.

The water and financial management project (1985-1991) identified control of water consumption and financial management as key issues in the management of Kenya rural water supplies. The Delineation study (1991) was a forerunner of the government policy in the early 2000 of the roles and of the government and intermediaries in the development of the sector. The Self-Help Experiment Project (1992-1994) contributed considerably to the understanding of the support requirement to self-help projects to make them sustainable¹¹⁰¹.

Community management water supply projects were an eye opener for the government. By the year 2000, the government had realized that it did not have the resources or capacity to operate, maintain and repair the hundreds of smaller water systems that had been constructed in the rural areas over the years. A realistic way to rehabilitate these projects was to hand over the responsibilities for operation and management (though not ownership) to community Water User Committees (WCUs). This concept was popularly known as “undertakership”. The handing over of responsibilities required working closely with communities to create awareness and understanding about the concept and its consequences. The challenge was worsened by the fact that, some of the systems which were to be handed over were either not functioning or functioning poorly. The process was expected to continue smoothly.

1099 Baker D (1978). Programmes (Exc. Settlement Water Supplies) 1978/79 to 1982/1983 Kenya National Archives, RP/9/6. Ref: WD/2/1/37, 22nd January 1978.

1100 BG Associates (2001). Post Project Evaluation of Kwale Water and Sanitation Project (KWASP), Final Report. Kenya-Sweden Rural Water and Sanitation Program. March 2001.

1101 BG Associates (2001). Post Project Evaluation of Kwale Water and Sanitation Project (KWASP), Final Report. Kenya-Sweden Rural Water and Sanitation Program. March 2001.

The communities were expected to take more responsibilities for infrastructure improvement. The Kenya/Sweden Rural Water Supply and Sanitation Programme was based on the concept of using Non-Governmental Agents (NGAs) to assist communities in mobilizing themselves and then to plan, finance and construct water supply and sanitation facilities. The project included components of training and preparing communities to manage, operate, and maintain their systems, plus health/hygiene education and promotion of latrine construction and improvements. Appropriate and affordable technologies were emphasized, as were aspects of sustainable management of environmental resources and gender. Improved access and coverage of facilities in selected communities over the entire country was a direct output of the project. In this project, NGAs functioned as project managers of community projects¹¹⁰².

The Kenya/Sweden rural water supply and sanitation programme included components of training for management, and sustainable operation and maintenance of systems, plus health/hygiene education and promotion of latrine construction and improvement. Appropriate and affordable technologies were emphasized as were the aspects of sustainable management of environmental resources and gender. Greater use of the private sector to provide goods and services underlined the concept of self-help. Improved access and coverage facilities were a direct output of the project. The project area comprised of three districts Nyandarua, Meru and Baringo. Under this project, communities were to meet some percentage of the expected construction costs. The target groups were District Technical Teams (DTTs), Private Sector Agents (PSAs) and Non-Governmental Agencies (NGAs)¹¹⁰³.

The Department of Water Development (DWD) was supposed to execute the proposed programme. As the principal executor and custodian of Water Act, DWD had the overall responsibility for policy formulation and regulation with regard to control of water resources and technical standards in the water sector. DWD was also responsible for planning, irrigation, dam construction, operation and maintenance of water supplies in rural areas and several urban centres in Kenya¹¹⁰⁴.

The government of Sweden through SIDA was expected to provide financial support to cover related personnel costs and allowances, supplies, equipment, materials and operational costs within the framework of ordinary government rules and regulation. In addition, SIDA was expected to provide technical assistance in form of

1102 BG Associates (2001). Post Project Evaluation of Kwale Water and Sanitation Project (KWASP), Final Report. Kenya-Sweden Rural Water and Sanitation Program. March 2001.

1103 BG Associates (2001). Post Project Evaluation of Kwale Water and Sanitation Project (KWASP), Final Report. Kenya-Sweden Rural Water and Sanitation Program. March 2001.

1104 BG Associates (2001). Post Project Evaluation of Kwale Water and Sanitation Project (KWASP), Final Report. Kenya-Sweden Rural Water and Sanitation Program. March 2001.

full time Swedish programme advisor based in Department of Water Development. Other responsibilities were to provide office facilities and stores, staff at all levels, and running costs for some vehicles. The government was expected to waive taxes and duties on major supplies and equipment imported for use under the programme. The communities were expected to collect money, provide labour and materials as part of their initial commitment. Communities were expected to meet all ongoing costs of operation, maintenance and repair of installed facilities¹¹⁰⁵.

The issue of technology choice was most directly relevant for those projects supporting installation of community based water supply and sanitation facilities. In case of water supply, projects based on simple, inexpensive technology that allowed uncomplicated and inexpensive operation and maintenance was favoured. On the other hand sanitation technology was expected to be, simple affordable solutions suited to local technical and socio-economic cultural condition along with health and hygiene education and proper use of latrines¹¹⁰⁶.

From 1984 to early 1986, the construction of new projects and rehabilitation of existing ones with baseline surveys and data collection began. Later in 1986 and 1987, community liaison and continuous involvement ensured. By 1988, substantial physical implementation of the rehabilitation works had been achieved. Selected community members were taken through on-the-job training to enable them serve as committee to the wider O&M management body. This was part of involvement of the beneficiaries through awareness, mobilisation, and participation in implementation to create a sense of ownership.

The projects were spread over six districts traversing areas of low through high land potentials and varied cross-section from easy to very difficult terrain, from areas high to low economic opportunities.

Operation and maintenance: This was considered the most intricate matter in project handing over and required a high level of discipline in regular system maintenance. A rigorous and lengthy training was necessary at both the water committee level and the project employees' level. Continuous and general community awareness follow up was considered very important to enhance project patrol care. These activities were being taken by KWAHO and were expected to continue until June 1991.

Water charges: The existing water charges were KES 2.00 per cubic metre for the first cubic metre and KES 2.65 per cubic metre for every additional cubic metre.

1105 BG Associates (2001). Post Project Evaluation of Kwale Water and Sanitation Project (KWASP), Final Report. Kenya-Sweden Rural Water and Sanitation Program. March 2001.

1106 BG Associates (2001). Post Project Evaluation of Kwale Water and Sanitation Project (KWASP), Final Report. Kenya-Sweden Rural Water and Sanitation Program. March 2001.

Those operating from a water kiosk paid additional KES 3.50 as metre rent. Such revenue was meant for operational and maintenance of the water supplies. Table 3.60 shows the cost summary of projects under Swedish support

Table 3.60: Overall cost summary under Swedish support

Project	Amount spent (KES)
Sericho	2,802,800
Dabel	5,648,000
Sololo	1,142,600
South Horr	2,020,300
Kabune	2,782,600
Others	6,128,400
Total	20,524,700

In 1986, the Ministry of Water Development (MoWD) with support from Swedish International Development Authority was in the process of implementing a shallow well technology project in Kwale District. The main aim of the project was to support initiatives of rural communities throughout the district in the construction of small point source of water supplies and simple sanitation

3.6.5 Danish Support

In the Kenya/Denmark Annual Aid Consultations that took place in Nairobi in November 1978, the Kenya team was informed that the Danish team was being recruited and would soon arrive in the country and assist in upgrading of projects in Rift Valley.

The suitable projects for upgrading were supposed to be forwarded to the Ministry of water development then to the Danida mission. The list would form the basis of initial work programme for the team. The upgrading or rehabilitation programme was estimated to cost Dutch. Kr 5.6 million¹¹⁰⁷

The aid that DANIDA promised RWS IV programme was KES 32 million. This was distributed over engineering services for Aguthi, Leiten, and Mumbi which disbursement commenced in 1977/78. Construction of Leiten and Mwimbi schemes

¹¹⁰⁷ Ndiho A.N (1978). Kenya Denmark Annual Aid Consultations. Kenya National Archives WD/1/2/24, Ref: WAT/OFTA/50. 21st December 1978.

disbursement started in 1980/82. The funding was not sufficient and the need for additional funding was requested from DANIDA¹¹⁰⁸. By 1983, the total DANIDA assistance was estimated to 1650 Kenyan pounds¹¹⁰⁹.

3.6.6 Other Support

WHO and UNICEF: Spring Protection in North Kavirondo.

Although the Ministry of Health played its biggest role during the environmental and sanitation programme (1960 to the early 1980's) instigated by the WHO/UNICEF for rural water supplies, its earlier role cannot be ignored. First the testing of water for biological as well as chemical quality in initial water supplies was done by the Ministry of Health to ensure that wholesome water was supplied to the populace. Later in the late 1950's i.e. around 1955 to 1961 the ministry of Health realized that springs provided much better source of drinking water than a river or stream. This fact was demonstrated in Bernard Shaw's paper entitled "Small water supplies in the rural areas of Kenya" written at a time when he was the provincial health inspector for Nyeri¹¹¹⁰.

It was after this paper that the Ministry of Health embarked on what was known as "Protection of Springs". The protection of springs was conducted country wide but the area of North Kavirondo formed the largest exercise of spring protection in the colony. Spring protection exercise was carried out by Health assistance and artisans (Fundis) who were assisted by Headmen from the various areas where such springs existed. After the protection exercise the headmen were to ensure the springs remained in good condition. First the Health Assistants had to carry out a field study to assess the number, usage, reliability and condition of the springs. Those that were found to provide water for a large number of people all year round were initially selected for protection. Secondly the Health assistant would then do a budget for the protection exercise and lastly the artisans would be called in to do the actual protection. This exercise took quite an elaborate procedure¹¹¹¹.

1108 Ndiho A.N (1978). Kenya Denmark Annual Aid Consultations. Kenya National Archives WD/1/2/24, Ref: WAT/OFTA/50. 21st December 1978.

1109 Kalinga J.K (1977). Nzeluni Water Scheme. Kenya National Archives, WD/1/2/24. 21st March 1977.

1110 Colony and Protectorate of Kenya (1961). Spring protection exercise in Kakamega District. Kenya National archives, Ref: DC/KMG/1/18/12, Nairobi, Kenya.

1111 Colony and Protectorate of Kenya (1961). Spring protection exercise in Kakamega District. Kenya National archives, Ref: DC/KMG/1/18/12, Nairobi, Kenya.

First step was to collect the water so that it can be discharged through a pipe rather than letting it continue to drip into the mud. To effect this, a small dam wall was built across the flow from the spring with foundations down to the impervious strata;

Second step was necessary in case there was more than one source from the spring to the spring. The presence of other channels flowing from the spring would undermine the effort to channel water to the pipe in the dam wall, thus before building the dam wall the area of the spring was cleared and all the flows followed to their respective point source. Then by means of stone drains led all the waters to the proposed outlet in the dam wall. The dam wall was thus constructed to sufficient length to cut off any tendency of such waters to flow around its extremities;

The third and last step involved the prevention of contamination of the water by preventing people or animals to the immediate environs of the spring source, especially the area in which work in form of stone drains had been done i.e. from the wall up to the sources of the spring; to prevent any damage to these works; and to prevent contamination from indiscriminate urination and excretion in the area above the wall.

Between 1958 and 1859, about 80 recorded springs were protected in Isukha location and the surrounding¹¹¹².

Roman Catholic Philanthropic Organisations

In at least two cases during the 1964-65 financial years Roman Catholic philanthropic organisations produced funds for water supplies in rural areas (Kilgoris and Kitui). These funds were availed to the Local Authority and spent under Roman Catholic general control. The Water Development Department indicated that it had to be involved in advisory capacity to ensure that the monetary assistance from philanthropic organisations was well utilized. In addition, the department intended to ensure that there was uniformity in standards and that such schemes did not clash with Government planning or policy for the area concerned, particularly in respect of agricultural and veterinary schemes¹¹¹³

1112 Colony and Protectorate of Kenya, (1961). Spring protection exercise in Kakamega District. Kenya National archives, Ref: DC/KMG/1/18/12, Nairobi, Kenya.

1113 Director, Water Development Department (1965). Rural Water Policy: Memorandum by the Director of Water Development Department. Water Development Department, Nairobi June 1965.

The World Bank

World Bank started providing monetary assistance in 1983 Before then the Bank provided technical support and guidance into informed running of the overall water development works¹¹¹⁴.

In its 1975-1980 project staff appraisal report, the World Bank outlined duties for individual departments in the water and agricultural ministries. Accordingly, planning, location and programming of proposed water supply was to be carried out in close cooperation between the Ministry of agriculture, the water department in the ministry of water development and the district development committees. Detailed design, technical specification, engineering standards, and tender documents were to be prepared by the water departments planning and design division. This was to be in accordance of their standards with the assistance of consultants if necessary¹¹¹⁵.

Employment of consultants had to comply with International Development Agency (IDA). Water development standards regarding consumption rate, water quality, design period, and typical structures had to be acceptable to IDA. Depending on the timing and location, water department could construct some schemes with its own direct labour section or employed contractors. The water department was to be responsible for maintenance of water supply schemes¹¹¹⁶.Handing over of Council Water Supplies

3.6.7 Taking/Handing over of Water Supplies

Bungoma County Council: The proposal that government should take over the running of the scheme from the Bungoma County Council was first made in 1967, but financial constraints and legal as well as transfer procedures prevented this from happening. The Water Development Department (WDD) took over the management of Kibichori water supply on 1st January 1973. The scheme was still technically operative but the department faced problems in establishing ownership of the farms, many of which had changed hands in the intervening years. Identification of individual consumers as well as opposition to the implementation of government water charging rules formed the other major problems¹¹¹⁷.

1114 Kalinga J.K (1977). Nzaluni Water Scheme. Kenya National Archives, WD/1/2/24. 21st March 1977.

1115 Kalinga J.K (1977). Nzaluni Water Scheme. Kenya National Archives, WD/1/2/24. 21st March 1977.

1116 Kalinga J.K (1977). Nzaluni Water Scheme. Kenya National Archives, WD/1/2/24. 21st March 1977.

1117 Colony and protectorate of Kenya (1960 – 1968). Kibichori water supply scheme. Kenya National Archives, Ref. No. Wat/West/1/1, Nairobi Kenya.

Isiolo County Council: Wario, the Isiolo County Council clerk, requested the water development department for a full takeover of the water supply at the council Bandas (where tourist stayed) in the Buffalo springs game reserve. This was impelled by the inability of the council to repair constant pump breakdowns during the year 1974. Towards the end of the year, the council installed a new machine, which operated smoothly. Wario argued that the council was understaffed and had no personnel to look after the water supply therefore the Water Development Department should take over the maintenance of the supply¹¹¹⁸.

Sirikwa County Council: Iten water scheme was taken over by the Ministry of Water development from Sirikwa County Council in 1973. The scheme was operational and consisted of spring catchment, pumping station, rising main 1800m length, reticulation system to supply the market centre as well as the school and various government office, high tension line to the pumping station (the installation had not been replaced with electrically driven pumps).

Aberdare County Council: Aberdare water supply had four units Nyeri, Nanyuki, Kiganjo, and Thomson falls. In October 1960, the Aberdare county council considered the government's offer to hand-over the supply. Messrs Howard Humphrey and Sons made a report on the value of the undertaking for the council. A meeting in May 1960 between the ministry of local government and ministry of public works agreed on valuation done based on costing. However, the council requested for consideration of the councils engineer valuation figures for the four supplies¹¹¹⁹.

It had been agreed that the transfer should be made without any loss to the government. They agreed on a proposal to grant a loan at 4%. The loan was given on the valuation calculated on the installed cost of the assets less the amount in the renewals in respect of the assets i.e. value minus renewals. He argued that in considering the valuation it was important to note that the council was not interested in running the water supplies as a non-profit public service but rather at good profits¹¹²⁰.

The hand-over: In November 1960, the council agreed on principal to take over the Aberdare water supplies offered by the government. The permanent secretary in the ministry of local government proposed that the council would get the consulting

1118 Wario H.H.W (1975) Taking over of Water Supply at Bandas –Isiolo Buffalo Springs Game ReserveK.N.A. DC/ISO/4/12/1, Ref: ISO/CC/ADC/PW/4/3/Vol.2/419, 18th February 1975

1119 Crane, W.K, (1960). Water Supplies. Kenya National Archives, ACW/31/103, Ref: URBAN/GEN/12/115. 28th October 1960.

1120 Chief Hydraulic Engineer (1960). Transfer of Water Supplies-Aberdare County Council. Kenya National Archives, ACW/31/103, Ref: DW:972/95. 7th November 1960.

engineer figures for the supplies and take over the water supplies offered. The proposal was approved and adopted at the finance and general purpose committee¹¹²¹.

In December 1960, the county clerk and the county engineer agreed with the revised valuation of the water supply offered to the council. However, they insisted that all items should be declared redundant as at the date of hand over. They also insisted that all items purchased from the renewable fund are included in the capital charges and detailed collections involving points raised by the councils consulting engineers to be made.

After these issues were considered the value was approximately 173,685 pounds. The deputy chief hydraulic engineer stated that the final figure should range within plus or minus 1500 pounds of the above quoted figure. The government assured the Aberdare county council that it would give the council all possible assistance to ensure that trained staff is available at each supply. Further instructions had been given to transfer Thomson falls water works from the jurisdiction of the divisional engineer Nakuru to that of divisional engineer, Nyeri¹¹²².

The government agreed to hand over to the local authorities the Kitale and Aberdare water supplies on July 1, 1961, under condition that all necessary arrangements were completed by then. Mr. O.S Knowles wrote to the Ministries of Public Works, Agriculture, and the local government and lands to stress the importance of a Sessional paper. Sessional paper was a means by which any sale or transfer to the Local council of assets or property worth 10,000pounds and above was reported to the legislative council¹¹²³.

Nakuru Water Supply: Under the railway management new connections were added in a haphazard way resulting in a state of affairs such that it could not supply reasonable demands for water nor could any further new connections be added, notwithstanding that the supply available suffice for a town of twice its population¹¹²⁴.

The control and maintenance of the water supply was eventually seeded to the Public Work department in 1923 as opposed to the initially preferred Senior Administrative officer Nakuru and a sum of KES 18,000 (900 pounds) paid to the Uganda Railway in 1924 as final settlement, which had been agreed to by the railway.

1121 PS, Local Government and Lands (1960). Aberdare County Council, Transfer of Water Supplies. Kenya National Archives, ACW/31/103, Ref: 4/232/26. 13th December 1960.

1122 PS, Local Government and Lands (1960). Aberdare County Council, Transfer of Water Supplies. Kenya National Archives, ACW/31/103, Ref: 4/232/26. 13th December 1960.

1123 Knowles O.S, (1961). Letter F.276/1/8. Kenya National Archives, ACW/31/103, Ref: DVO.24. 15th May 1961.

1124 Birch H.M (1923) Nakuru Water Supply. Proposed Construction of a Distribution System of Nakuru Water Supply Kenya National Archives AG/43/104 Ref: 1569/111/2/4. 18th July 1923.

It was viewed that efficiency would be better served by vesting sole responsibility in the PWD¹¹²⁵

The second transfer: Nakuru water supply once again changed hands from Public Works Department (PWD) to the Nakuru Municipal Board (NMB) from January 1st 1929. This was probably due to a lot of work and fewer employees. Although officially the NMB was to take over the management of Nakuru water supply from 1st January 1929, this was postponed until 1930 to allow PWD to complete the approved work on the extension of Nakuru water supply. The financial details of the handing over had also to be worked out.

Mombasa Water supply: In 1927, the commission proposed that the Mombasa Municipal Board should take over from the Government the Mombasa Water supply as it was essentially a Municipal undertaking and existed mainly for the purpose of supplying water within the municipal area. It recommended that the basis of acquisition by the Board was to be based on transfer of the existing capital liabilities subject to the provision by the Government of an adequate reserve fund for the renewal of assets¹¹²⁶.

Baringo Water Supply: The Baringo District Development Committee recommended the government to take over all the county council water supplies and the council had no objection. The minister had promised to send a team of his officials to survey the Perkerra River for a dam of storing water for use during the dry season when scarcity was experienced. Further to look into the possibilities of supplying water from Ngusuria water spring was to be undertaken as to serve markets like Kiboimo. The minister was informed that the entire district should be placed under Rural Water Supplies III and the people looked forward towards implementation of that¹¹²⁷.

On 27th July 1981 the clerk to the county council of Baringo, D.K. Boiywo, informed the district water officer that the council was ready to officially hand over the Bartolimo water supply to ministry on 3rd August 1981¹¹²⁸. In January 1981, Mr. Mutito directed the DDC Trajanow, to arrange to take over the Soy and Koitegani

1125 Rhodes G.D (1922) Nakuru Water Supply: Uganda Railway General Managers Office Nairobi. Kenya National Archives AG/43/104 Ref 790 II/58618th August 1922.

1126 Colony and Protectorate of Kenya (1927). Report of the Local Government Commission 1927, Vol 1 Nairobi and its Environs and Mombasa and its Environs. K. 352. 1927.

1127 Nasieku D.K (1975) Official Visit of the Minister for Water Development Hon. E. Mwamunga to Baringo District on 8th and 9th March 1975. Kenya National Archives, RP/21/23, Ref: MOW/8/3/VIII/156. 21st March 1975.

1128 Boiywo D.K (1981). Water Supplies Take Over. Kenya National Archives, RP/21/23, Ref: CCB/WS/11/2/Vol.11/448. 27th July 1981.

Ranch water projects. This was from consequent discussions held with the Hon. E.C Kiptanui, MP, assistant Minister for water development¹¹²⁹.

Kitale Water Supply: The Municipal Board of Kitale agreed in principle, by a resolution passed on 23rd September 1960, to the transfer of the Kitale water undertaking from the Ministry of Works to the Municipal Board. The Town Clerk requested arrangements of a visit by a representative of the ministry and one from the hydraulic department, to discuss the basis of an agreement¹¹³⁰.

Consequently, the chief hydraulic engineer prepared a memorandum dealing with hand over matters. Officers and members of the board considered the memo and the government representatives from ministry of works and local government discussed the points arising from the memo.

They agreed that the board should pay to the government an approximate sum of 109,000 pounds, subject to adjustment for the actual cost of assets installed up to 30th June 1961. This was approximately 9,000pounds for 17 years. The board had just installed a sewerage system at a substantial cost and was facing considerable financial difficulties in the early years of the scheme. The principal repayment in the first year was agreed at 4,600 pounds. The estimated revenue from water was 24,000 pounds, which was expected to enable the board to pay the cost in full in consecutive years. The permanent secretary for ministry of local government was mandated to appeal to the treasury to accept the board and the ministerial request¹¹³¹.

In November 1960, Knowles wrote to confirm the treasury viewpoint as per the meeting held in the Ministry of Agriculture. He noted that the municipal board primarily required an understanding that if they get into financial difficulty because of the take over their position would receive sympathetic consideration¹¹³².

The transfer of Kitale water undertaking to the Municipal Board took effect in August 1961. As anticipated, the board incurred extra expenditure requested for the refund through the town clerk as had been agreed in November 1960¹¹³³.

1129 Mutito C.N, (1980). Water Supply to Marigat Center, Asal Project. Kenya National Archives, RP/21/23, Ref: WD/2/1/119/17. 25th August 1980.

1130 Altorfel (1960). Transfer of Water Supplies, Municipal Board of Kitale. Kenya National Archives, ACW/31/78, Ref: 412.Vol.iii.166. 4th October 1960.

1131 Permanent Secretary (1960). Transfer of Water Supplies-Municipal Board of Kitale. Kenya National Archives, ACW/31/78, Ref: 41206/11. 22 November 1960.

1132 Knowles, O S (1960). Transfer of Kitale Water Supply. Kenya National Archives, ACW/31/78, Ref: DVO.60. 30th November 1960.

1133 Town Clerk (1961). Transfer of Kitale Water Undertaking. Kenya National Archives, ACW/31/78, Ref: WAT.27/2. 8th August 1961.

3.7 Water Tariffs

3.7.1 Origin and Progression

The issue of water charges has been and remains a thorny issue especially as it conflicts with the person's right to water. The first water tariff can be traced to 1904, when the manager of the railway station in Nairobi proposed the first water charges at a flat rate of five rupees, since there were no metres. By 1908 metres started being fixed and charges shifted from a flat rate to a metered consumption. The major reason was maintenance and controlling wastage. The charges for water were affected in Mombasa and Nairobi, which were the main townships then. The rest of the Country had no piped water supplies¹¹³⁴.

Although the need to charge for water was realized rather early in the turn of the century, it seems not to have been emphasized, probably due to few piped water supplies and low client base. Various areas however charged for water to collect funds for operation and maintenance.

To complement the Nairobi Township Rules, 1917 which was vague on water tariffs, the Municipal Corporation Ordinance of 1922 allowed the municipal council of Nairobi to formulate By-laws which were known as the "the Nairobi (Water Rates) Bye Laws, 1923¹¹³⁵.

The bye laws provided for disconnection of water supply from the premises in case of a default and reconnection only be made after payment and reconnection fees were paid¹¹³⁶. The water charges for Kisumu varied a bit from those in Nairobi. Those who had not been put on metres were to paying a flat rate of KES 10 per month.

Until 1927, the native employees of the government in Kisumu were paying a flat rate of two shilling per month. Under the proposed scheme the District Commissioner, Central Kavirondo, noted that metres would be fitted and special rates be granted for the government employees¹¹³⁷.

Under section, 153 of the Water Ordinance of 1951 and with the approval of the Minister for Agriculture Animal Husbandly and Natural Resources, the director of public works made amendments to the regulation and schedules. They took financial effect from the first water accounts issued after 31st December 1956.

1134 British East Africa protectorate (1915), Payment of water rates by government officials, Circular No. 33. Kenya National Archives, Ref: pc/coast/1/22/26, Nairobi Kenya

1135 British East Africa Protectorate (1916). Draft Water legislation. Kenya National Archives, Ref: AG/43/76, Nairobi, Kenya.

1136 British East Africa Protectorate (1916). Draft Water legislation. Kenya National Archives, Ref: AG/43/76, Nairobi, Kenya.

1137 Colony and Protectorate of Kenya (1929) Water Supply, ref. PC/NZA/3/9/3/2, PC/NZA/3/9/3/1, Kenya National Archives, Nairobi Kenya.

According to the amendments, where a metre was installed, a monthly rent, became payable at 2.50 to 10 shillings, corresponding to the nominal size of the metre i.e. from half-inch size metre up to three-inch size metre. Where metres in excess of 3-inch size were used, a special metre rate was fixed based on 1.25% of the installed cost. The minimum charges for a metered connection without a metre rent ranged from 7.50 to 10.00 shillings¹¹³⁸.

In Meru, a ministerial approval to charge 2.50 shillings per 4.5m³ to all licensed retailers hydraulic engineer was made in 1955. The same statement provided that the standard rate to consumers of two cents per debe was to remain. This rate was effective as from 1st august 1955¹¹³⁹.

The standard tariffs applied according to the purpose and whether or not a metre was installed. Where no metre was installed, monthly charges ranged from 10 to 20 shillings for domestic use and rate of 40 to 80 shillings charged for building purposes. Where metres were installed, three to five shillings, according to the type of tariff, per 4.5m³ of water used were charged monthly. Water sold from a kiosk or through a licensed retailer, charges ranged from 0.2 to 0.3 cents per 18 litres. For water sold in excess of 136 m³ through one metre in any one month a charge of 2.40 to 3.20 per 4.5m³ in excess of 136m³ was chargeable. Bulk rate only applied at water supplies specifically gazetted as allowing a bulk rate¹¹⁴⁰. Table 3.61 illustrates a historical timeline of water tariffs in Kenya between 1904 and 1983

Table 3.61: Timeline status of the history of water tariffs between 1904 and 1983

Year	Type of rate	Charges	Location	Reason
1904	Flat rate	5 Rupee	Nairobi	Operation and maintenance
1908	Metered and flat rate		Mombasa Nairobi	Control usage and for effective operation and maintenance
1922	Metered and Flat rate	10 KES/Month for those not metered	Nairobi	Operation and maintenance
1927	Flat rate	10 KES/Month	Kisumu	Government native employees

1138 Brown J.L (1956). The Water Ordinance, 1951, K.N.A. DC/GRSSA/6/13, Ref: Gazette Notice No. 3566, 21st November 1956.

1139 Hydraulic Engineer (1955) Licensed Retailers of water General Notice No. 1681, Official Gazette Published 20th July 1954. K.N.A. DC/MERU/2/15/11, Ref: DW:951. 7th September 1955.

1140 Brown J.L (1956). The Water Ordinance, 1951, K.N.A. DC/GRSSA/6/13, Ref: Gazette Notice No. 3566, 21st November 1956.

1951	Metered	2.50-10 KES/ Month	Nationally	An attempt to introduce metres nationally including rural areas
1956	Flat rate and Metered and Bulk rate	10-20 KES/Month-domestic use, 20-80 KES/Month-building purposes and 3-5 KES/1000 gallons in metred	Nationally	Segregation intended to bring equity in payments and lessen non payments
1958	Metered and Flat	Tariff rates increased from 3-7 KES	Nationally	Circular 4. First comprehensive charges introduced nationwide
1968-1983	Flat and Metered	Rural water supply improvement		

3.7.2 Water Metre problems

In 1959, insufficient supply of water in Garissa led to the pumps were pumping a lot of air and the metres and therefore metres continued recording leading to numerous complaints from the consumers. Consumers went without water for some time whereas metres continued to register. Though the government boma was on a separate reticulation, it suffered the effect of the drought. The district commissioner considered the fairest arrangement was to charge consumers half the amount of water registered by the metres from 1958. Alternatively, a flat rate decided¹¹⁴¹.

The water rates varied from one town to the other depending on the capital outlay expended on the provision of the water supply. Metered charging was advocated and followed vigorously in the major townships already mentioned. It was not until 1958, when the famous circular No 4 that the first comprehensive water charges were introduced Countrywide. In 1958 the tariff categories were again increased from three in 1954, to seven.

3.7.3 Challenges in Water Pricing

The water rates of 1958, elicited a lot of problems in so far as the Northern Frontier District (NFD) was concerned and complains were launched as to the inapplicability of the water rates to the Northern Frontier District. This was because some of the water supplies were only partially treated, or were delivered by carts. The natives in this area did not have the money to pay for such water supply. In 1975, the tariff

¹¹⁴¹ Souta A (1959). Garissa Water Supply, K.N.A. DC/GRSSA/6/13, Ref: PW.8/4/11/535, 6th June 1959.

blocks increased from seven to seventeen. The charges were still established on both volumetric and flat rate charging. The charges varied from region to region depending on the investment put on the water supplies. The water charges under this Legal Notice were significantly higher than their predecessors. This probably was due to inflation. The Presidential directive of April 1981 on rural tariffs and prices replaced the different tariffs with common tariff¹¹⁴².

Metres were expensive to install, were stolen or tampered with easily in rural areas, and were not effective. In periods of wet weather, alternative sources of water were used rendering revenue unreliable. It was clear that there was no readily workable method and general levy was introduced by 1965. Rate collection was the most challenging aspect of the water tariff development¹¹⁴³.

In 1910, water in Samburu was supplied from one tank from the stationmaster, which contained about 1500 gallons. The people, who travelled a distance of about four miles, were each given one gallon¹¹⁴⁴. When the administration started selling water, it was a great failure. Less than one water tank was sold and the total number of people coming for water dropped drastically¹¹⁴⁵. In 1912, once again the natives were short of water after the water holes had dried up and a tank was dispatched to Samburu. A trusted government employee was sent to collect fees at six cents per tin.

After selling water for fourteen days, the seller had been able to collect only 84 cents. The natives refused to pay for water¹¹⁴⁶. The charge for water was the greatest hardship for the Africans whose attitude was epitomized by the remark that water was a gift from god which should not be bought or sold, as was the case of meat. The assistant district commissioner suggested a reduction of the rate from six cents¹¹⁴⁷. By December 1913, there was no water that had been sold¹¹⁴⁸.

Conflict between the Chief accountant and the DC regarding collection water revenue arose in Isiolo whereby the DC ignored the recovery of revenue arising from 60 cents increment, from 2.40shillings to 3shillings per 45.5 litres for consump-

1142 Director, Water Development Department (1965). Rural Water Policy: Memorandum by the Director of Water Development Department. Water Development Department, Nairobi June 1965.

1143 Director, Water Development Department (1965). Rural Water Policy: Memorandum by the Director of Water Development Department. Water Development Department, Nairobi June 1965.

1144 Sigh S (1910). Water Supply for Samburu: Copy of Letter from Santa Sigh, Samburu to the Director of Transport, Mombasa, Kenya National Archives, PC/Coast/1/13/13. 22nd September 1910.

1145 Sigh S, (1910). Water Supply for Samburu: A Letter to the Director of Transport, Mombasa, Kenya National Archives, PC/Coast/1/13/13. 21st October 1910.

1146 Assistant District Commissioner (1912). Water Supply for Samburu. Kenya National Archives, PC/Coast/1/13/13. 22nd August 1912.

1147 Assistant District Commissioner, Rabai (1913). Shortage of Water in the Northern Duruma Location. Kenya National Archives, PC/Coast/1/13/13, Ref: 366/11/29. 12th December 1913.

1148 Assistant District Commissioner, Rabai (1913). Shortage of Water in the Northern Duruma Location. Kenya National Archives, PC/Coast/1/13/13, Ref: 374/11/29. 20th December 1913.

tion in excess of per 136m³ per month. In addition, the DC ignored 2.50 shillings increment for the minimum rate¹¹⁴⁹.

In **Turkana District**, only small revenue could be collected from water charges if boreholes were made in Turkana province. The PC attributed this to the high poverty level among the Africans¹¹⁵⁰.

In October 1958, the District Engineer inspected water supply in Lodwar. It was found that the Kiosk was open all day long and no charge was made for water supplied from it.

The DC stopped this and made the kiosk be opened for two periods of one hour each day and to charge for water supplied at two cents per 18 litres. The DC agreed also to supply locked cashbox issued daily by his cashier. The main intention was increase the revenue and reduce the demand from nomadic, non-employed Turkana who used the Kiosk almost entirely. They could fetch water from the sand holes in the river just as they used to do before installation of the kiosk¹¹⁵¹.

In July 1959, the government agreed to the payment for water on flat rate based on the Gazetted rate of five shillings per 4.55m³. This was attributed to the sand, which was constantly in the supply system at Lodwar making it difficult to metre the consumers. This was applicable only in, the prison, hospital, school, police lines and the administration¹¹⁵².

In 1953, water charges for metered connections were four shillings per 1,000 gallons with a minimum charge of 13 shillings a month. The kiosk charge was four cents per four gallons (10 shillings per 1,000 gallons). The average domestic consumption per household was 5,000 gallons per month. The District Commissioner Marsabit wanted the water rates to be kept within the reach of the average consumer so that the boma and morale of its inhabitants could improve. Consequently, he proposed a reduction in water rate from 4 shillings per 1,000 gallons to 2.50 shillings per 1,000 gallons with a minimum charge of 13 shillings a month¹¹⁵³.

According to water use study, between 1968 and 1983, the government carried out a major development programme to provide improved water supplies to the populations of rural areas and to improve and extend service in the urban centres. A major successful expansion of water supplies was carried out during this period. However, the rural population coverage remained low and much remained

1149 Chief Accountant (1955). Isiolo Water Supply. Collection of Public Works Revenue. Kenya National Archives, BB/PC/EST/7/34, Ref: LA/WS/121A, 21st September 1955.

1150 PC, Turkana (1930). Water Boring, K.N.A, DC/LDW.2/24/3, Ref: PW.3/1, 31st October 1930.

1151 Divisional Engineer (1958). Lodwar Prison Water Supply, K.N.A, DC/LDW.2/24/10, Ref: W.418/14639, 16th June 1958.

1152 Permanent Secretary for Works (1959). Lodwar Water Supply, K.N.A, DC/LDW.2/24/10, Ref: CA. 313/338, 30th July 1959.

1153 DC, Marsabit (1953). Marsabit Water Supply-Charges, Kenya National Archives PC/EST2/7/3, Ref: PW.8/8/Vol.11/265, 17th September 1953.

to be done. The operation of the scheme brought up several problems and the water supply in the rural sector was not earning enough money to cover the operation and capital cost¹¹⁵⁴.

It was feasible for Kenya to provide piped water supplies to the most of the population on a basis which covers an acceptable share of the costs and in an equitable manner. However, to achieve such an objective required far reaching changes in the existing system of administering and charging for water use¹¹⁵⁵.

3.7.4 Tariff and Metering Policy

The general tariff and metering policy as stated in the 1974-1978 Development Plan was¹¹⁵⁶:

“The government policy is that everybody must pay for water services”. The rates level however, was, to be such that the revenues would cover “direct operations and maintenance costs for the rural water supply schemes”.

New tariffs were to be introduced to take into account ability to pay off the water users in different parts of the country. The communal supplies were to be limited to kiosks to “facilitate collection of water rates”. The plan also indicated that both urban and rural water supplies should not serve as a source of general revenue, i.e. water charges should not be raised to provide funds for the general revenue. Water tariff system underwent a number of changes between 1970 and 1983 bringing about four different water tariffs in force in Kenya¹¹⁵⁷:

- The rural tariff.
- The urban tariff.
- The Nairobi City Council tariffs.
- The Mombasa Coast tariffs.

In 1953 the Town Clerk, Nairobi City Council issued the following terms and condition for the supply of water by the City Council¹¹⁵⁸:

1154 Republic of Kenya (1983). Water Use study: Draft Main Report. Ministry of Water Development, September 1983.

1155 Republic of Kenya (1983). Water Use study: Draft Main Report. Ministry of Water Development, September 1983.

1156 Republic of Kenya (1974), Development Plan 1974-1978. Government Printer, Nairobi.

1157 Ministry of Water Development (1983). Water Use Study, Main Report, 1983.

1158 Reseborough J. (1953). Terms and Conditions for the Water Supply. Kenya National Archives. RN/6/28. 1953.

- The City Council of Nairobi would make connection to supply water main and lay the service to the metre location and provide the necessary ferrule connection, piping and stopcock for this work, but the cost of materials and labour involved was to be paid for by the consumer. In every case the Council reserved the right of determining the diameter of the service pipe, taps and sizes of metre, and no alteration whatsoever was to be made without the previous sanction of the City Engineer.
- The consumers of water or owners of the property were required to bear the cost of all piping and fitting for their supply and were at liberty to employ any authorized plumber to do the work on the metre or the council could undertake to do the work exclusive of the internal fittings if requested to do so but, the consumer or owner would bear the cost. The consumer was to be responsible for the proper upkeep and repair of all stand pipes and piping for his supply as laid down in the Municipality By-Laws. All connections and plumbing work would be subjected to inspection by an Inspector appointed by the Council and no water could be turned on until it was passed as complying with the requirements of the council relating to the private supplies nor until the costs of any work executed by the council were paid.
- Supplies were granted on the understanding that the consumer agreed:(a) to the charge for water being determined by metre (b) to provide a suitable site for the metre (c) to allow the Council's Officer free and unrestricted access thereto, and to all the pipes and fittings on his supply and (d) to pay to the council on demand the amount of any damages caused to any metre or apparatus of the council otherwise than by fair wear and tear even though such damage may be due to the act of any person over whom the consumer has no control, this would be determined by the person discharging the office of the City Engineer and the decision would be final and binding on the Council and the consumer.

Within the Municipality the occupier was supposed to pay the following charges to the Council:

- A monthly charge of KES 20 per 1000 gallons of water consumed according to the reading of the meter, payable in arrears on demand. Such monthly charge should not be less than KES 5.50. Where the monthly consumption exceeds 50,000 gallons, a graduated scale of charge would be made, viz:
 - 1st 50,000 gallons at 2.20 per thousand gallons
 - 2nd 50,000 gallons at 2.00 per thousand gallons

- 3rd 50,000 gallons at 1.90 per thousand gallons
- Balance at 1.80 per thousand gallons
- Council may at their discretion suspend the minimum charge.

Outside the municipality

Monthly charges were as above, with an additional charge of twenty five percent, provided that such charges:

Would be varied by express agreement between the council and such occupant.

Shall not be made for the period during which the supply was cut off from the water mains.

If a connection exceeds $\frac{3}{4}$ inches in diameter, a monthly meter rent shall be paid to the council in arrears on demand: two shillings for a 1-inch connection and three shillings for other sizes not exceeding 3 inches. Such monthly charges shall be payable in addition to any charge already paid for the water.

The council also suggested that if the customer was dissatisfied with the registration of the meter, the council would charge 10 shillings in advance to test it. If the meter was found to be registering within $2\frac{1}{2}$ percent either way of the actual quantity passing it, it was considered to be correct. However, if the meter deviated for more than $2\frac{1}{2}$ percent, the difference could be allowed or added accordingly as the meter registers fast or slow and the charge made for the test would be refunded.

In cases where an application for a supply was made and there was no supply main within a reasonable distance, the applicant was required to sign a special agreement undertaking to pay a charge which was equal to 10% per annum of the cost of the length of the main and fittings required to be laid to ensure a supply in addition to the ordinary connection. The charge was to be made at once and reduced when a sufficient number of consumers were to be supplied to cover a return of thirty percent, including the charge for water and the outlay concern.

All water charges were to be paid monthly on demand. Water was to be cut off if any account was more than fourteen days overdue and legal proceedings taken for the recovery of any charge due. In all cases, except change of tenancy, a charge of KES 10 was to be paid for turning on or reconnecting a service¹¹⁵⁹.

An application for a supply was to be made on special forms printed and obtained from the Town Hall, Nairobi. Applications were dealt with in the order of priority of date, but the council reserves the right of executing the work in a manner which was best suited to its convenience. The council undertook to supply the consumer

¹¹⁵⁹ Resborough J (1953). Terms and Conditions for the Water Supply. Kenya National Archives. RN/6/28. 1953.

occupying the premises on the reserve as much water as the pressure at the main connection could permit, but the council was not liable for any failure to supply water or for any defect in the quality of the water supplied however caused¹¹⁶⁰.

Subject to the consumer fulfilling and not contravening the conditions hereof, the council agreed to that the supply of water to the consumer without disconnection unless such action deemed necessary by the city engineer for the improvement on the general supply and then only after notifying the consumer that the council intends to interfere with or stop the supply and for what periods and for what reason. Such notification published in one issue of a local newspaper by the council was sufficient notice thereafter, but in the event of emergency work being necessary due to any cause whatsoever, the city engineer had the right to cut off any supply or supplies to permit of such work being executed and no notice would be required nor should any consumer affected by such action have any claim against the council.

The consumer was responsible for the upkeep and repairs of standpipes and any water pipe or fittings which lay within his premises, and should damage be caused to a third party by reason of consumer's neglect to keep such standpipes in repair, the council could not accept any responsibility for the same. Repairs to the standpipes would be executed by the council at the request of the consumer, but all the repairs thus executed should be paid for in advance by the consumer. The council could not responsibility for the water wasted as a result of the defects on the consumer's side of the meter.

Consumers were required to conserve the water as much as possible, and the council reserved the right to cut off the water supply to any premise where there was wilful waste or improper use of water. This especially applied to water running from any tap, pipe or other fitting that had been left with water turned on.

It was an offence to use water for irrigation of gardens by running water into irrigation channels without written permission from the city engineer, likewise, it was an offence to use a hose pipe for any purpose whatsoever from any water supply pipe belonging to the council or service pipe without permission. No pipe or fitting connecting with the council water mains, whether situated inside or outside of the municipality, was to be laid, removed, altered or extended on any consumer property until full details of the proposed works and of the materials to be used thereon had been submitted to and approved by the city engineer.

Kisumu Municipality: Kisumu water supply was obtained from both the municipal supply and the rural supply. However, there were as significant number of popula-

1160 Resborough J (1953). Terms and Conditions for the Water Supply. Kenya National Archives. RN/6/28. 1953.

tion that was not connected directly to the municipal water supply system but were acquiring water from vendors. More than a hundred water Kiosks were connected to the municipal water supply system and only four of them were operated by the Kisumu Municipal council with the rest either registered or unregistered operators. The Kiosks were operated from 6am to 7pm for 365 days a year¹¹⁶¹.

Kisumu municipal council sold water at a price of KES 0.8 per 25-litre container; the rate for bulk water was KES 50 per metre cubic. The daily turnover per kiosk was KES 300 to 500.

Money was collected by the operator assigned by Kisumu Municipal council and delivered to KMC the following morning. The major customers were water vendors who sold water to end users at approximately KES 5 per 25 litre container which was about 6 times higher than the buying price. The rates were uncontrolled and fluctuated upwards during drought. There were a total of 96 registered water Kiosks within the municipal water supply system. KMC required a deposit of 14000 for registration. KMC sold water to the registered users at an average rate of KES 40 per m³. There were also considerably large numbers of unregistered water kiosks being operated within the municipality. The source of water for these kiosks was the municipal water supply system and partly water taken from the nearby rivers and private shallow wells¹¹⁶².

3.7.5 Government Policy on Pricing

One of the major constraints of comprehensive analysis of pricing options was lack of reliable and sufficient cost information. The first government policy on cost sharing in the water sector was put in place in 1974-1978 Development Plan¹¹⁶³. This principle was endorsed in subsequent plans and policy documents with water considered as economic good. It was understood that the government policy intended that all consumers should pay for water on the basis of user pay principle. In the Sessional Paper 1 of 1999¹¹⁶⁴, water tariffs were set in a manner that the scheme was self-sustaining. It also stated that water abstraction was charged in accordance

1161 Colony and Protectorate of Kenya (1913-1959) Kisumu water supply, BY/35/2 Kenya National Archives, Nairobi, Kenya.

1162 Nihon Suido Consultants Co., Ltd and Nippon Koei Co., Ltd (1998). The study on Kisumu Water Supply and Sewerage System in the Republic of Kenya Draft final report Vol 2. Master Plane. Japan International corporation Agency. Ministry of Local Authorities, Kisumu Municipality Council. June 1998.

1163 Republic of Kenya (1974). Development Plan 1974-1978. Government Printer, Nairobi.

1164 Republic of Kenya (1999). Sessional Paper No. 1 of 1999 on National Policy on Water Resource Management and Development. Government Printers, Nairobi.

with the amount of water abstracted and the use of those funds for water related activities¹¹⁶⁵.

However, real economic costs had negative impact on vulnerable groups of the population. As a result, it was proposed that efforts be made to develop a tariff structure that both ensured adequate cost recovery for water supply and protection for the rural poor. It was also stated that effluent discharge levies be introduced in accordance with the polluter pay principal.

By the year 2002, there lacked clear government objectives for water pricing. These were the best practice objectives widely used in the design of water tariffs; these were fairness and equity, cost recovery, incentives, and simplicity and comprehensibility. Tariff setting was done in the year 2002 under the responsibility of the Ministry of Environment and Natural Resources. The MENR and NWCPC managed systems had uniform nationwide tariffs.

Consequently, consumers of MENR or NWCPC operated systems were charged the same across the country regardless of the cost of production and supply. Tariffs were set after a consultation process between the district water officers, The NWCPC regional managers and the directorate for water development in the MENR. Tariffs were revised November 1999 and were expected to be adjusted in the year 2004. The local government was expected to set its own tariffs for its water supply systems. However, the minister had not approved the local government tariff policy by the year 2002¹¹⁶⁶.

By the year 2002, most rural schemes prices were at KES 20 a month per household disregarding the amount of water consumed. In water schemes where decision making powers had been devolved to the communities, charges were moved to a unit price per jerry can fixed by the community groups. There were ten different categories of metre rents. Categories and associated metre rental charges varied according to the size of the metre. Metre rents ranged from KES 50 (e.g. for domestic connections) to 1500 (e.g. large consumers). Deposits were paid before the connection was installed. The tariff schedule differentiated between fifteen different consumer groups including domestic consumers, water Kiosks, commercial and industrial consumers, health facilities and schools¹¹⁶⁷.

1165 The Government of Kenya (2002). Preliminary Report on the Comparisons of Options: Review of Options for Private Sector Participation in the Provision of Water Supply and Sewerage Services in Mombasa and Coastal Region. World Bank Funded Project. September 2002.

1166 The Government of Kenya (2002). Preliminary Report on the Comparisons of Options: Review of Options for Private Sector Participation in the Provision of Water Supply and Sewerage Services in Mombasa and Coastal Region. World Bank Funded Project. September 2002.

1167 The Government of Kenya (2002). Preliminary Report on the Comparisons of Options: Review of Options for Private Sector Participation in the Provision of Water Supply and Sewerage Services in Mombasa and Coastal Region. World Bank Funded Project. September 2002.

3.7.6 Indirect costs of informal water supplies

In addition to their direct costs, there may be additional indirect costs that unconnected households have to bear. These may include, time and efforts required to access water sources, health risks and or environmental costs¹¹⁶⁸.

3.7.7 Water conflict

According to H.K. Sikes the Chairman, Select Committee on Water Bill, 1928,

‘...there is no single matter which gives rise to so much unfriendliness between the farmers as uncontrolled water dispute¹¹⁶⁹’

The Select Committee appointed by the Legislative Council in August 1928 to consider and report on the provision of the Water Bill of 1928 granted, among other things, that there shall be established for the control of water rights a Water Board on behalf of the government¹¹⁷⁰.

It was desirable that there be provided specifically for the safeguarding of rights already granted in land titles, or by agreement with government. Of these water rights majority of them had been granted by lease or agreement which the board would have preferred to be liable under the Water Ordinance so as to re-establish in more definite terms in respect of quantity, point of diversion, method of diversion and use of the water¹¹⁷¹.

The establishment of a Water Appeal Board, to which there should be an appeal from the Water Board in cases where a licence was cancelled by the Water Board. It was felt that the Water Board as was proposed to be constituted and advised, as it was to be by technical Officers was the best Authority for giving final decisions on the problems before it. However, because in case of exceptional and those extreme cases when a license has been cancelled by the water board, a review of the decision by an independent authority on appeal against the decision by the aggrieved party, thus the recommendation for the establishment of Water Appeal Board consisting of

1168 The Government of Kenya (2002). Preliminary Report on the Comparisons of Options: Review of Options for Private Sector Participation in the Provision of Water Supply and Sewerage Services in Mombasa and Coastal Region. World Bank Funded Project. September 2002.

1169 The Secretary (1928). Report of the Select Committee Appointed to Consider and Report upon the Provision of the Water Bill. Kenya National Archives. W1/3/3. August 22nd 1926.

1170 The Secretary (1928). Report of the Select Committee Appointed to Consider and Report upon the Provision of the Water Bill. Kenya National Archives. W1/3/3. August 22nd 1926.

1171 The Secretary (1928). Report of the select Committee Appointed to Consider and Report upon the Provision of the Water Bill. Kenya National Archives. W1/3/3. August 22nd 1926.

a judge of the High Court to be appointed by the Governor on advise of the Chief Justice and two other persons appointed by the Governor¹¹⁷².

The Native rights and interests were, according to the committee adequately safeguarded. It was considered that the presence of Chief Native Commissioner and three other Heads of Department on the Water Board, the statutory need for publication of application for water rights and the inherent right of the native to appeal to the Governor in the Council and if necessary to the Secretary of State, constituted full security. The committee felt that cases may arise when a Native who might be affected, or even District Commissioner of the district in which he resides, would not be aware of the published notice. Consequently, the committee recommended that a new clause 27 of the bill providing, in case when the applicant relates to diversion, obstruction or use of a body of water within, abutting on, or flowing under a native reserve, that a copy of the draft notice shall be sent to the District Commissioner who is required to cause any native within his district who might be affected to be informed of the terms of the application. Any native objecting to the licence being granted had then an opportunity to lodge an objection and represent his case to the authorities before a licence was granted¹¹⁷³.

In the mid-twenties, Mr. H.K. Sikes, the Director for Public works had established a procedure to be followed when one applies for Water Rights. He decided to take measures to ensure that each applicant knew the conditions, giving as much security of tenure as possible and at the same time safeguard government and other users, both present and prospective. The steps leading to issuance of a water permit were as follows;¹¹⁷⁴

Procedure for Application of Licence

Application, giving details of the proposal to the Executive Engineer on a form, (which also stated the conditions on which permits were issued) accompanied by sketch map illustrating the proposals.

When the application was in order, the Executive Engineer submitted an 'Objection Form' to each riparian holder, who was likely to be affected if the application were granted¹¹⁷⁵.

1172 The Secretary (1928). Report of the select Committee Appointed to Consider and Report upon the Provision of the Water Bill. Kenya National Archives. W1/3/3. August 22nd 1926.

1173 The Secretary (1928). Report of the select Committee appointed to consider and report upon the provision of the Water Bill. Kenya National Archives. W1/3/3. August 22nd 1926.

1174 Sikes H. K (1926). Report by Mr. A.D. Lewis on Irrigation etc. in Kenya Colony, 1925. Kenya National Theatre. A.G. 43/87. July 18th 1926.

1175 Sikes H. K (1926). Report by Mr. A. D. Lewis on Irrigation etc. in Kenya Colony, 1925. Kenya National Theatre. A.G. 43/87. July 18th 1926.

Executive Engineer received views of the riparian holders as expressed in the 'Objection Forms.

If no objection existed, or if overcome, submitted the file to the chairman of the District Committee with his view stated verbally or in writing. If objection existed, or if the Executive Engineer disagreed, or was dissatisfied, from the government's viewpoint, with the application was submitted, or if other circumstances necessitates examination, correspondence or visit would ensue as each case demands. When objections were overcome or reduced or when it was apparent that they could not be overcome, without further action, the file was sent to the chairman of the District committee of the District. The applicant and the objectors were given an opportunity to attend and state their cases¹¹⁷⁶.

Hearing by the district committee, by whom the advice was expected to issue a Permit, to refuse it or to issue it in a modified form.

Dispatch of the file with the Executive Engineer's comment to the Director of Public Works.

If the Director of the Public Works agreed with the recommendations of the Executive Engineer and the District Committee the permit was issued in those terms.¹¹⁷⁷

Institutional conflict has been a significant challenge to water development process in Kenya. Subjective and diverse opinions and priorities by various departments and duplication of duties among different institutions entrusted with water development have retrogressed the process¹¹⁷⁸. Mombasa in 1934¹¹⁷⁹, Kajiado in 1953¹¹⁸⁰ and Nyeri in 1960¹¹⁸¹ experienced conflicts at departmental level that greatly jeopardized the water and sewerage improvement. By 1955, the Public Works Department, Ministry of Health and the Ministry of Agriculture were responsible for water supply and sanitation development hence lacking a department responsible for overall water development issues¹¹⁸².

1176 Sikes H. K (1926). Report by Mr. A. D. Lewis on Irrigation etc. in Kenya Colony, 1925. Kenya National Theatre. A.G. 43/87. July 18th 1926.

1177 Sikes H. K (1926). Report by Mr. A. D. Lewis on Irrigation etc. in Kenya Colony, 1925. Kenya National Theatre. A.G. 43/87. July 18th 1926.

1178 Town Clerk (1934). Water for Public latrines. Kenya National Archives, BY/29/1, Ref: 33/4. 13th November 1934.

1179 Town Clerk (1934). Water for Public latrines. Kenya National Archives, BY/29/1, Ref: 33/4. 13th November 1934.

1180 District Commissioner (1953). Sanitary Services in the Townships. Kenya National Archives. BY/21/107. August 6th 1953.

1181 Davies E.R (1934). Nyeri Urban District Council Housing. Kenya National Archives, BY/21/73, Ref: H.4/20/3, 23rd May 1960.

1182 Colony and Protectorate of Kenya (1957). Sessional Paper No.98 of 1957. The Manzoni Report on the Public Works Department. Government Printer, Nairobi 1957. Kenya National Archives, MSS/66/111.

The government recognized this deficiency and commissioned Sir Herbert Manzoni in 1956 to investigate and recommend organisational reforms of the Public Works Department. He recommended separation of Hydraulic branch from Public Works department to become an organisation of its own under the ministry of agriculture in the post 1960 planning. The recommendations were carried out in 1964¹¹⁸³.

Conflicts over water use have had a history in Kenya, and it was prompted by diverse reasons. For example, violation of native rights; In the early colonial period; the process of alienation of land for white settlement and the forced reallocation of natives thus denying them their rights to natural resources had an impact on the pre-existing systems. This led to loss of indigenous rights to natural resources and the creation of a latent set of property reclamation rights that could be activated at moments of regime change. For instance in Taveta reserve, the following water questions led to violation of indigenous water rights in 1934¹¹⁸⁴.

An application by Messrs Teita Concessions, to draw water from Ngulu Swamp. This was not approved by the government.

A complaint, arising out of Messrs. Homer Bros, at Taveta for a permit, that an existing furrow was taking necessary water supplies from the native reserve, coupled with a claim for compensation. The complaint was said to be unfounded.

Complaints by the natives of Mbololo that taking of the water by the railway from the Kigala stream constituted a hardship. This was met for the Railways who promised to erect a trough to conserve water in times of drought.

Complaints of irregularities in the taking of water by Dwa Plantation at Kedai. These were met by granting a permissive annual permit to the company and a construction of head works where a maximum of 256 cusec or half a stream (whichever is less) only could be extracted.

A furrow taken out at Ngerenyi was found to be irregular.

To solve the above problems and others which arose when Kasigau destroyed the Teita Concession Limited water supply a special well was provided by the company for use by the tribe in 1935. Toward the end of the year negotiations begun with the Railways Administration for the provision of free or at least cheaper water supply in Voi Township for native consumers¹¹⁸⁵. While in 1936 The Uganda Railways and

1183 Colony and Protectorate of Kenya (1957). Sessional Paper No.98 of 1957. The Manzoni Report on the Public Works Department. Government Printer, Nairobi 1957. Kenya National Archives, MSS/66/111.

1184 District Commissioner (1934). Annual Report for Teita District, 1934. Kenya National Archives. DC/TTA/1/1/2.1934.

1185 District Commissioner (1935). Teita District Annual Report for 1935. Kenya National Archives. DC/TTA/1/1/2.1935.

Harbours made an application to the District Commissioner to divert water from the lesser Lumi River to supply the Taveta station but permission was not granted¹¹⁸⁶.

Conflicts due to communities living in catchment areas being denied benefit of water when the headwork of a supply were developed at local water points and alternative points not provided have been evident in Kenya. In 1958 Vihiga water supply was developed from springs which were already in use by the local community without an alternative supply being shown to them.

The Secretary to the African District Council in North Nyanza wrote as follows concerning the spring take-over to the District Commissioner, North Nyanza in 1958.

‘I note that the Government intends to take over the spring from which the local inhabitants at Vihiga draw their water and also that the Government is not willing to allow the local inhabitants to have free water supply from the Vihiga Water supply’.

Eventually the question of an alternative supply for the inhabitants was never answered.¹¹⁸⁷

Conflicts due to scarcity of water: Competition of use as a result of high demand and inadequate supply leading to illegal allocations and abstraction by illegal farmer out growers for example in Mwea Rice scheme, over 15000ha of land were irrigated illegally thereby doubling the water demand without corresponding supply. Similarly in Burguret upstream commercial horticultural farmers who had leased land but were unwilling to join the water association in fear of getting bound by rationing laws and regulations undertook illegal abstractions using pumps¹¹⁸⁸

Seizing of Native Land: In 1904-05, the British forcibly moved certain sections of the Maasai out of their favourite grazing grounds in the central Rift Valley into two reserves in order to make way for white settlement. Seven years later, the British went back on their word that they would not in future take any more Maasai’s land and moved the ‘northern’ Maasai again, at gunpoint, from Laikipia to an extended Southern Maasai Reserve. This second move was not completed until 26 March 1913. White settlement of the highlands was the primary reason for expulsion.

1186 District Commissioner (1936). Teita District Annual Report for 1936. Kenya National Archives. DC/TTA/1/1/2.1936.

1187 Colony and Protectorate of Kenya (1958). Vihiga Water Supply. Kenya National Archives. DC/KMG/2/26/21.

1188 Munguti K. K (2003). Towards a Water Secure Kenya: Social Economic assessment of Water Resources Issues, development needs and Challenges in Kenya, a Draft Report of the world bank, Nairobi Kenya.

The Maasai chiefs were against the move as they argued that the proposed territory was not large enough and with limited water resources that sprang from European allocated areas¹¹⁸⁹.

Inter-tribal battles between the Kenya tribes themselves over watering and grazing rights have also been a major conflict especially among the pastoralist tribes. As early as 1949 Farson reports this in the Northern Frontier District which currently cuts through the Rift Valley, North-Eastern and Eastern Provinces. This kind of conflict remains common today especially during droughts in these areas. These conflicts over water use have been increasing over time¹¹⁹⁰.

Lack of equity in allocation: Upstream versus downstream users, this was caused by poor allocation procedures where upstream users abstracted more legally or illegally at the detriment of the downstream users. This was the case in Yatta Canal where large-scale farmers are all at the upstream end¹¹⁹¹. Farson (1949) while commenting on the illegal furrows on Uaso Nyiro also noted that these furrows were not lined with cement and in many cases the water was allowed to run to waste in the bush instead of being returned to the river, as it should be, so that what remains of it could benefit the natives living down the stream. ‘Why the hell should natives have it?’ ‘Was a remark you would hear from many of the settlers. Most of the settlers were taking more water than they were allowed in one case a white farmer was taking seventeen times the amount of water that was allowed to him- this to grow maize on black cotton soil, just so that he could squeeze the last penny out of his farm and cheat posterity, and that nothing was being done to him¹¹⁹².

Poor method of gauging water flows by ministry when allocating abstraction permit. It was reported that the gauging was done during the wet season when there was flood flow rather than normal flow and this produced a false volume of water resulting to allocation of more abstraction points than the river can support during normal flow resulting to conflict. This was reported in Karatina (Ragati River) and Kyeni East groups¹¹⁹³.

1189 Hughes L (2006). Moving the Maasai, A Colonial Misadventure. Palgrave Macmillan, in Association with St Antony's College, Oxford.

1190 Negley F (1949). Last Chance in Africa, Victor Gollancz, London.

1191 Munguti K. K (2003). Towards a Water Secure Kenya: Social Economic assessment of Water Resources Issues, development needs and Challenges in Kenya, a Draft Report of the world bank, Nairobi Kenya.

1192 Negley F (1949). Last Chance in Africa, Victor Gollancz, London.

1193 Munguti K. K (2003). Towards a Water Secure Kenya: Social Economic assessment of Water Resources Issues, development needs and Challenges in Kenya, a Draft Report of the world bank, Nairobi Kenya.

Water abstraction permit: The mandate of issuing permits and authorisation for abstraction of water was with the Ministry of Water Resources Management and Development. The process was expensive and cumbersome and was open to abuse and was a major source of conflict. It took about 6 months to obtain a license¹¹⁹⁴. The long period lead people to start abstracting water illegally example in the Uaso Nyiro watershed where the Europeans had started growing crops, which they irrigated with water from the tributaries of the Uaso Nyiro River. Here many furrows had been made without permission of the Water Board, in fact in open defiance of it¹¹⁹⁵.

The Muthaiga water Company had sought to construct its own source from the Ruaraka River but was denied by the Public Works department. However, permission was only granted to tap water from the existing Kikuyu Springs Railway water supply to Nairobi. The company operated until around 1923 when Muthaiga water supply was taken over by the Nairobi Municipal Corporation¹¹⁹⁶.

In 1922, Machakos water supply remained unsatisfactory and the Government had no funds to meet the cost of installing a pipeline, the public works department was not willing to leave the matter to private enterprise thus the people continued to suffer¹¹⁹⁷.

No private agency could have been quite effective in those matters so closely associated with the health and well-being of its consumers. It was asserted that only through municipal ownership could water rates be regulated effectively, since private companies were more likely to pass along to the consumer the heavy costs of rate cases. Also profits would be kept home¹¹⁹⁸.

By 1955 there was no formal standard of water quality laid down in Kenya to adhere to, thus there was no clear cut rule to deal with the discontent, but suggestions were that as far as the complaints on water quantity were concerned, the matter was within the sphere of hydrology. Whereas in case of quality, it was necessary to obtain the advice of a Medical Officer and in case where by the Local Authority was also the Public Health Authority, it was suggested that any complain for water quality was to be referred firstly to the Medical Officer of Health, and then action under

1194 Munguti K. K (2003). Towards a Water Secure Kenya: Social Economic assessment of Water Resources Issues, development needs and Challenges in Kenya, a Draft Report of the world bank, Nairobi Kenya.

1195 Negley F (1949). Last Chance in Africa, victor Gollancz, London.

1196 Colony and Protectorate of Kenya (1913-1923). Muthaiga Water Supply. Kenya National Archives, Ref: AG/43/103, Nairobi, Kenya.

1197 Senior Commissioner (1922). Report by the Senior Commissioner for the Nine Months Ending December 31st 1921. Kenya National Archives. PC/CP/4/2/2 1922.

1198 Martin V M (2000). The Sanitary City. 4th, march, 2000.

section 145 of water Ordinance, was only to be taken by the Hydraulic Branch of the Ministry of Agriculture when so requested by the Public Health Authority¹¹⁹⁹.

Yet by 1971, there were no organisation with authority on water development but several agencies involved in community water supply and many more in other water sectors. This prompted formation of Water Development Division (WDD) within the ministry of Agriculture.

WDD had neither the status nor the resources to act as an authority and arbitrator on water matters¹²⁰⁰. These efforts either, did not work and in 1972, the Water Development Division was elevated to a Department, which was given the overall responsibility for water development in the country¹²⁰¹. The Ministry of Local Government (MoLG) was in charge of water supplies in major municipalities. The necessity for more separation and control led to formation of a fully-fledged Ministry in Charge of Water affairs in 1974¹²⁰².

3.8 Water Policy and Legislation

3.8.1 Water Policy

Until the 1940s, although water development continued mainly in townships, there was no written national plan on how to mobilize the country's water resources. The water development was in most cases ad hoc and usually undertaken at a township level and basis. Each township had its own water development plan cut out¹²⁰³.

The first formal water development plan known as the "Dixey scheme" was put forward in 1943 and covered the water scarce areas of the Northern Frontier District namely Moyale, Marsabit, Wajir, Garissa, Lodwar, Isiolo, Samburu and Mandera. The report covered various aspects including the existing water supplies, necessity

1199 For Permanent Secretary to the Ministry (1959). Complaints Regarding Quality of Water Supplied by Private Water Undertakers. Kenya National Archives. BY/35/15 Ref WAT 36/33/27, 14th April, 1959.

1200 WHO (1971). Sectorial Study and National Programming for Community and Rural Water Supply Sewerage and Water Pollution Control. Report No.1. General community water supply problems, Brazzaville.

1201 WHO (1972). Sectorial Study and National Programming for Community and Rural Water Supply Sewerage and Water Pollution Control. Report No 2. Recommendations on National Programme for Community Water Supply Development. Brazzaville.

1202 WHO (1973). Sectorial Study and National Programming for Community and Rural Water Supply Sewerage and Water Pollution Control. Report No 10. Recommendations on Administration and Organization Structure for Water Supply Development. Brazzaville.

1203 Nyanchaga E.N and Ombongi K.S (2007). History of Water Supply and Sanitation in Kenya, 1895-2002. Environmental History of Water, Chapter 21. IWA Publishing, Alliance House, 12 Caxton Street, London UK.2007.

for improvement, topography and geology and most importantly the recommendations for improvement¹²⁰⁴.

African Land Development Schemes: Late 1950's and early 1960's, as land became scarce in Kenya's highland district, arid and semi-arid lands (ASAL) became focus for agricultural expansion. 22 districts lied at least partially within the ASAL and comprised some 88 percent of the total land area of Kenya. In 1946, policies specifically aimed at intensifying ASAL production emerged after the Second World War, initially through the African Land Development Board (ALDEV), which was established in 1946¹²⁰⁵.

Settlement schemes in Kenya were the direct result of the decision made by the government to spend 3million pounds for the reconditioning of African areas and African settlement under the Kenya ten-year development programme. The organisation set to deal with this programme was the African Land Development Organisation [ALDEV], which started in 1945 when the ten-year development programme was being prepared. The name of the board changed with years as it sharpened its goals from African settlement Board in 1945 to 1946, African settlement and Land Utilisation Board in 1946 to 1947. From 1947 to 1953, it was referred to as African Land Utilisation and Settlement Board and in 1953 to 1955 African Land Development Board [ALDEV].

Sessional paper no. 8 of 1945 set out the government's policy on land utilisation and settlement and defined the functions of African settlement board with emphasis to settlement on new areas. The shift of emphasis was therefore away from settlement in new areas to reconditioning, reclamation and resettlement of existing African areas. It was not the policy of ALDEV to maintain the schemes after the initial period of establishment¹²⁰⁶.

ALDEV focused on water development and rangeland management by reducing herd sizes within controlled grazing schemes as colonial administration regarded extensive pastoralism as intrinsically harmful to the environment and a constraint on social and economic improvement as areas like around all permanent watering along the Uaso Nyiro, the Tana, Daua Rivers and around well centres such as Wajir, El Wak, Buna and Debel were extensively damaged¹²⁰⁷

1204 Dixey F (1950). Hydrological report on the Northern Frontier District, Samburu and Turkana and Report on the hydrology of the Uaso Nyiro. Kenya National Archives.

1205 Provincial Commissioner (1946). Annual Report Northern Frontier District, 1946. Kenya National Archives. PC/NFD/1/1/8, 1946.

1206 Waddicar H (1958). Settlement Schemes in Kenya. Kenya National Archives, BY/6/2. 28th October 1958.

1207 Provincial Commissioner (1946). Annual Report Northern Frontier District, 1946. Kenya National Archives. PC/NFD/1/1/8, 1946.

Plans to increase cattle production through the provision of water supplies in areas where none existed¹²⁰⁸, cattle dips and veterinary services, supported by research into improving pasture usage, were proposed by the central government and development agencies. As a result, a number of piping schemes were installed in the “non-scheduled areas”, the principal being Kabare, Zaina, Lolkeringet and Kibichori in the Bungoma District. All these schemes were designed and installed by the ALDEV organisation and handed over to the Local Authority to run. Finance for the major schemes was normally loans, but in the case of Zaina there was also an element of grant. The loans for rural water development were administered by the Agricultural Finance Corporation which managed them on behalf of the Treasury¹²⁰⁹.

In 1953, the colonial administration introduced emergency policy to control the mounting political pressure from the Africans¹²¹⁰. This policy negatively affected the seemingly progressing water sector since the priorities of the administration shifted to containing political pressure rather than water development. This policy led to coercion of people to live in secluded areas, the detention camps where overcrowding and lack of water and proper sanitation prevailed. The role of the three authorities that provided water was rendered redundant and drainage ditches, swamps and muddy boreholes became the water sources¹²¹¹. Based on the Principles of good governance, the colonial administration in all areas, failed.

The third formal water development plan known as “the Swynnerton Plan” was established in 1954 under the Ministry of Agriculture by the Deputy Director Mr. Swynnerton. The plan was officially known as the ‘plan to intensify African agriculture through increased cultivation of cash crops and through mixed farming featuring improved cattle for dairying. To achieve the plan’s objectives, it provided for a substantial expansion of field staff of the agricultural and veterinary departments, greater attention to training institutes for farmers, more ample funds for agricultural development including credit for farmers and cooperatives, and a campaign to promote land consolidation and enclosure¹²¹². The plan’s aim was to raise income levels of Africans in general by the cultivation of cash-crops in privately owned farms¹²¹³. This was a way to appease the growing discontent among the Africans

1208 Provincial Commissioner (1946). Annual Report Northern Frontier District, 1946. Kenya National Archives. PC/NFD/1/1/8, 1946.

1209 Water Development Department (1965). A Memorandum by the Director, Water Development Department, Ministry of Agriculture Animal Husbandry and Natural Resources. Kenya National Archives, Ref: BY/35/17. Nairobi, Kenya.

1210 Campbell, M.J (1956). Rural Labour Housing: A memorandum on the Housing of grouped farm workers. Kenya National Archives, BY/40/2, 10th March 1956.

1211 Caroline E (2005). Britain Gulag, the Brutal End of Empire in Kenya. Jonathan Cape, London

1212 Robert M. Maxon, Conflict and Accommodation in Western Kenya. The Gusi and the British 1907-1963Z.

1213 Swynnerton, J R M. Kenya’s Agricultural Planning, African Affairs, volume 56, number 224, July 1957.

as a large amount of their most productive land had been alienated to Europeans settlers, whereas African were confined to non-schedule areas, where population grew relatively rapidly and land became increasing scarce.

By 1940's land pressure was believed to be causing economic hardship in the reserves which posed an increasing severe political problem for the colonial government and contributed to the Mau Mau revolt of 1952. This resulted in two-pronged plan presented by Swynnerton in 1954, sought to ameliorate land scarcity by reforming the tenure system and intensifying agricultural production in the native reserves. The policy was also meant for the improvement of all African farming and grazing areas throughout the colony¹²¹⁴. Central to this plan was the contention that sound agricultural development was dependent upon a system of land tenure which could make available to the African farmer a unit of land and a system of farming which required a security of tenure through an indefeasible title. This envisaged individual land ownership, the consolidation of fragmented landholdings and measures to prevent further subdivision through creation of 600,000 farming units. But agricultural development was synonymous with water development and provision of water formed an integral part of the Swynnerton plan. Most parts of the Nandi District and the Coast Province benefited well from this development plan¹²¹⁵.

This policy had a negative impact in that with its implementation, the colonial government was preparing to create permanent socio-economic divisions within the Africans society based on access to land, and in future landed and landless Africans mostly the kikuyu were divide largely along the fault line between the loyalist and Mau Mau¹²¹⁶.

General implications of the policies undertaken: African Land Development Board (ALDEV), which was established in 1946 focused on water development and rangeland management. This had a negative impact on agriculture as government extension officers tended to be livestock specialists and had little training in horticulture. As a consequence the use of pesticides, this posed serious health hazard to producers and consumers of vegetables because of the pollution impact¹²¹⁷.

This also led to the concept of group ranching emerged in the 1950s which was not legislated until after independence in 1963. Over the past three decades, much of the more productive areas within the ASAL, such as upland peripheries

1214 Elkins C (2005). Britain Gulag; the Brutal End of Empire in Kenya. Jonathan Cape, London.

1215 Bolony and Protectorate of Kenya (1954). General notice No. 1681. Government printers.

1216 Caroline Elkins (2005). Britain Gulag; the Brutal End of Empire in Kenya. Jonathan Cape, London.

1217 Bernstein H., Hulme D. and Woodhouse P. (2000). African Enclosures? The social Dynamics of Wetlands in Drylands. Oxford: James Currey, 2000,

and wetland niches had fallen under individual control, as Kenya's land registration programme had been implemented.

Immediately after the completion of the borehole to supply water in Ngong Township another problem set in; the Maasai who had provided land on which the borehole at Ololua had been built wished to be provided with a trough and free water for watering of their livestock. In a Baraza held by the Local Native Council of Ololua, the natives proposed that to solve the problem Public works department ought to provide compensation in the form of free water, or alternatively that they ought to pay an annual rent for the land they had taken for the borehole and that water should be paid for from the money collected as rent¹²¹⁸.

Immediately after independence in 1963, from the British, the new government took a firm grip of the helm using five-year development plans to harness the rapid development of the new-born republic. At independence, the population had grown by more than 3 million since 1948¹²¹⁹. Moreover, urban populations had boomed. The young independent nation now faced a serious backlog of urban services for Africans, especially housing¹²²⁰. But in terms of water policy, the new government mainly confirmed the colonial policy during the first years of independence. The first development plan from 1964-70 was mainly a carry-over from the colonial period, in which focus was on economic growth¹²²¹. Water development was declared to be important for the economy, and priority was given to schemes that were expected to be financially self-sustaining, such as water services for the municipalities¹²²². The policy of cost recovery was continued and all supplies had to be assessed from an economic viability point of view:

“Unless there is a very good reason government will not accept a water scheme that is financially or technically unsound and is likely to be a continuing liability on the country's resources”¹²²³.

Even the doctrinal Sessional Paper No 10 of 1965 on African Socialism and its application to planning in Kenya, which directed Government policy towards priority

1218 Colony and Protectorate of Kenya (1946). Maasai District Ngong Water Supply. Kenya National Archives, Ref: DC/Ngong/1/14/1.

1219 Morgan W. T. W (1969). 'Urbanization in Kenya: Origins and trends', *Transaction of the Institute of British Geographers*, No 46, March 1969 pp 167-178.

1220 Stren R (1972), 'Urban policy in Africa: a political Analysis', *African Studies Review* 15:3, December 1972, pp 489-516.

1221 Ochieng W. R (1995). 'Structural and Political Changes', in Ogot B A and W R Ochieng (eds), *Decolonisation and Independence in Kenya 1940-93*, James Currey Ltd, London, pp 83-109.

1222 Government of Kenya (1964), *Development Plan 1964-1970*.

1223 Ministry of Natural Resources and Wildlife, Water Development Department. Circular dated 1965-09-01. the Organisation of water development. Notes for guidance of Provincial Water Advisory Committees. Kenya National Archives, DC/KMG/2/26/39.

concerns for Africans, regarded water as a public service alongside such services as transport, telecommunications and electricity, not as a social service to be subsidised¹²²⁴.

Around 1970, government policy shifted and water development became a prioritised area for intervention. By this time, urban areas had almost universal service coverage with a standard that was deemed high in comparison to international standards. However, in the rural areas, services were much less developed¹²²⁵. Backed by a strong economy, showing a sustained growth rate of more than 6% per annum, an ambitious programme for a state-led expansion of water development was launched in the Development Plan 1970-74. The programme had the objective of “bringing acceptable water supplies to all the rural population before 2000” and the government’s financial contribution to water development was to increase five-fold¹²²⁶. The rural areas were given priority, but the urban water budget also increased. The Plan did not any longer mention cost recovery as an issue, however, it stated that municipalities should consider increased water tariffs in order to secure revenues for investment needs¹²²⁷.

In the Development Plan for 1974-78, universal access to ‘safe and adequate’ water by the year 2000 had become a goal in itself. The government argued that water supplies would bring benefits in the form of higher income, security, health and leisure and that generally “a significant social benefit was attached to a water supply project”¹²²⁸. The total government water expenditure would increase more than six-fold and expenditure for urban water would triple (*ibid*, 186). But to keep up with urban growth was demanding. WHO estimated in 1973 that the budget increase for the urban sector would not be enough, and that manpower would also soon be a limiting factor¹²²⁹. The government itself concluded that: “Services for urban population has expanded over 70 years to cater for the present 1 million urban inhabitants.

The coming 25 years towns will have to develop services for another 8 million people. Rate of service provision development has to go up with a factor 20 as compared to the past”¹²³⁰. The strategy adopted was to boost central government in its role as service provider, as further decentralisation had been halted. The water

1224 Republic of Kenya (1965). African Socialism and its application to planning in Kenya. Sessional Paper No 10.

1225 World Health Organisation (1972). Sectorial study and national programming for Community and Rural water supply, sewerage and Water pollution control, Report No 2. Recommendations on national programme for community water supply development, WHO Brazzaville.

1226 Republic of Kenya (1969b), Development plan 1970-1974.

1227 Bernstein H., Hulme D. and Woodhouse P. (2000). African Enclosures? The social Dynamics of Wetlands in Drylands. Oxford: James Currey, 2000.

1228 Republic of Kenya (1974). Development Plan 1974-1978. Part 1, Government Printer, Nairobi.

1229 World Health Organisation (1973), Sectorial study and national programming for Community and Rural Water Supply, Sewerage and Water Pollution Control, Report No 12. Ten Year Development Programme for Community Water Supplies, WHO Brazzaville.

1230 Republic of Kenya (1974). Development Plan 1974-1978. Part 1, Government Printer, Nairobi.

development division was upgraded to a department in 1972 and in 1974 it became a fully-fledged ministry on its own: the Ministry of Water Development (MoWD)¹²³¹.

The direct influence the Minister exerted over policy also increased with the revised water legislation of 1972. In the 1974-78 plan, the government's policy on cost recovery was re-affirmed: "It was intended that systems for urban supply and sewage disposal become self-supporting financially as rapidly as possible and, the general tariff and metering policy was laid down stating that, "everybody must pay for water services". The rates lever however, was, to be such that the revenues would cover "direct operations and maintenance costs for the rural water supply schemes". New tariffs were to be introduced to take into account ability to pay the water users in different parts of the country. The communal supplies were to be limited to kiosks to "facilitate collection of water rates". The plan also indicated that both urban and rural water supplies should not serve as a source of general revenue, that is water charges should not be raised to provide funds for the general revenue, and four different water tariffs were to be force in Kenya. These were: (a) The rural tariff; (b) the urban tariff; (c) the Nairobi City Council tariffs; and (d) the Mombasa Coast tariffs¹²³².

However, the government policies implementation was hampered by the following factors.

The economic recession, after years of plenty in the 1960s, the economy slowed down considerably after 1972 mainly due to the oil crisis. The economy revived in the mid-1970s much thanks to high coffee prices in 1976, but throughout the 1970s the economy was characterized by a poor balance of payments, a high government budget deficit and inflation. Despite this, government spending kept increasing¹²³³.

Before the economic recession, skilled manpower, technical advice and logistics had been reported to be in short supply, affecting the operations and expansion of urban as well as rural water supplies¹²³⁴. Financial sustainability had also dwindled: in 1972 the ministry-operated urban supplies could no longer recover capital charges¹²³⁵. The inflation would soon make matters worse. Already in 1975 a WHO review mission made it clear that the financial situation of the water supplies under

1231 World Health Organisation, Report of the review mission for the Water Supply, Sewerage and Pollution Control "Sectorial Study" for Kenya. Kenya National Archives, BY/33/72, April 1975.

1232 Ministry of Water Development (1983). Water Use Study, Main Report, 1983.

1233 Onjala J O (1999). Economic Growth and Development in Kenya since independence,' in N Ng'ethe and W Owino (eds), From Sessional Paper No 10 to Structural Adjustment: Towards Indigenising the Policy Debate, Institute of Policy Analysis and Research, Nairobi pp 55-92.

1234 WHO (1971). Sectoral Study and National Programming for Community and Rural Water Supply Sewerage and Water Pollution Control. Report No.1. General community water supply problems, WHO Brazzaville.

1235 WHO (1972). Sectoral Study and National Programming for Community and Rural Water Supply Sewerage and Water Pollution Control. Report No 2. WHO Brazzaville.

the MoWD was unsustainable, with insufficient maintenance resulting in the deterioration of infrastructure. WHO frankly concluded that “there is no link between the real costs of providing water and sewerage services and revenue collected for the services”. As the tariffs were not revised to keep in step with inflation, real urban water tariffs in Kenya did in fact go down by 75% from 1971 to 1989¹²³⁶. The inflation also derailed the capital expenditure programmes. Together with poor technical and financial estimates, the inflation made programmes such as the MUWSP experience cost increase by over 300%. And although the government’s development budgets kept expanding at an impressive rate, the high inflation rate in the 1970s and 1980s would consume most of the increase since 1972.

Expansion of urban water services was also compromised by the failure of the government’s housing development initiatives; at independence in 1963, the government was the main house provider. It provided especially low income housing with over subsidized rental housing schemes while demolishing informally built settlements. Restrictive policies emphasizing appropriate ‘house’ planning were pursued. Demolitions and/or disapproval of ‘unplanned’ houses were central in restrictive policies. The independent government continued the policies from the colonial period, which encouraged segregation manifested in racial zoning¹²³⁷. This perpetuated the housing shortage through enforcing strict building regulations¹²³⁸. In 1964 a housing survey was carried by a UN mission to Kenya, the mission recommended the establishment of a housing authority within a new Ministry of Housing. This led to the establishment of the National Housing Corporation (NHC), replacing the colonial Central Housing Board¹²³⁹. With reference to “slum areas”, the government endeavored in 1969 to “take more positive action to prevent this undesirable type of development”¹²⁴⁰.

In Nairobi, this meant that more housing units were demolished in slum-clearances than what was being built through the government programmes. Furthermore, standards were so high that the houses that were built were only affordable for the

1236 Hukka J and T Katko and O Seppala (1992). Kenya Water Sector-A Position Paper, Tampere University of California Press, Berkeley.

1237 Parker, M. 1948. ‘Political and Social aspects of the Development of the Municipal Government in Kenya, with Special Reference to Nairobi’. London, Colonial Office.

1238 Mitullah W V (1999). ‘A Review and Critique Urban Housing Policy in Kenya: 1963-1995,’ in Ng’ethe N and W Owino (eds), From Sessional Paper No 10 to Structural Adjustment: Towards Indigenising the Policy Debate, Institute of Policy Analysis and Research, Nairobi pp 219-239.

1239 Mitullah W V (1999). ‘A Review and Critique Urban Housing Policy in Kenya: 1963-1995,’ in N Ng’ethe and Owino W (eds), From Sessional Paper No 10 to Structural Adjustment: Towards Indigenising the Policy Debate, Institute of Policy Analysis and Research, Nairobi pp 219-239. Republic of Kenya (1969b). Development Plan 1970-1974.

1240 Republic of Kenya (1969b). Development Plan 1970-1974.

middle and high class income people¹²⁴¹. By 1970 the rationale of the policy of demolition was being questioned by planners and administrators. In any case, it was based on the premise that the government would manage to reduce rural/urban migration by enhancing rural development and at the same time would manage to provide adequate urban housing, aspirations which remain unfulfilled to date as unplanned areas increase and expand. The shortage of planned and affordable housing led to a proliferation of slums, without proper water and sanitation¹²⁴².

Due to the above factors, in 1979 it was obvious that the government's goal of "water for all by the year 2000" was not going to be met. The government accordingly reformulated its goal in the Development Plan for 1979-83: "to have an adequate water supply available to the entire population soon after the year 2000"¹²⁴³. On the other hand, water was now stated to be a social service to be provided by the government along with education and health services, under a strategy named the 'Basic Needs approach'¹²⁴⁴. Under this approach, cost recovery from users was not prioritised. This strategic shift in the fourth plan coincided with the launch of the "International Drinking Water Supply and Sanitation Decade" around 1980, where donors together with developing countries made a dedicated effort to increase access to water and sanitation worldwide¹²⁴⁵.

Rural Water Policy

In most other developing countries, Kenya included, a major limiting factor in rural water development was the provision of finance. By 1965, investigations into rural water policy called for consideration into various means by which funds were provided for water development purposes in rural areas. These were, those from the portfolio of the Minister for Natural Resources and Wildlife: Rural water grants, rural water piping schemes, non-gazetted water supplies funds, subsidies for unsuccessful boreholes and dam Subsidies¹²⁴⁶. Other funds that were not coming at present within the portfolio of the Minister for Natural resources and wildlife were institutional water supplies funds, range water supplies, agrarian loans for community projects, settlement scheme water supplies, Agricultural Finance Corporation (AFC) loans to

1241 Stren R (1975). 'Urban policy and performance in Kenya and Tanzania', *The Journal of Modern African Studies* 13:2, June 1975, pp 267-294.

1242 Odira P M A and E N Nyangeri (1994). 'Water and Sanitation services in low-income areas of Nairobi, Kenya' in S Sandelin (ed), *Low-income area water supply and sanitation in selected African cities*, Tampere University of Technology, Tampere.

1243 Republic of Kenya (1979). *Development Plan 1979-83. Part 1*, Government Printer, Nairobi.

1244 The Basic Needs Approach was a strategy Promoted by global actors, see e.g Curry and Totchild (1980).

1245 Hukka J and T Katko and O Seppala (1992). *Kenya Water Sector-A Position Paper*, Tampere University of California Press, Berkeley.

1246 Director, Water Development Department (1965). *Rural Water Policy*. Water Development Department. Nairobi.

private individuals (boreholes), UNICEF, philanthropic organisations, flood control funds and coastal Protection¹²⁴⁷.

Rural water grants were provided for rural schemes with an agricultural bias; this vote was never intended for example to provide water supplies to trading centres. Immediately prior to the setting up of this department, policy with regard to Rural Water Grants was controlled by the Central Agricultural Board in consultation with Regional Agricultural Boards and District Agricultural Committees. The organisation initiating a request for a scheme was the District Agricultural Committee to whom proposals made by the local people came in the first instance.

In July 1964, the policy on rural water expenditure was made within the Ministry of Agriculture while the Permanent Secretary for Natural resources was the Accounting Officer responsible.

As in the first six months of the existence of this Department it was not possible to produce a reasonable workable alternative arrangement and by 1965, the Central Agricultural Board in conjunction with the Rural Water Adviser laid down the priorities for the 1965-66 expenditure.

The method adopted by the ALDEV organisation and the Central Agricultural Board for the disbursement of these Rural Water monies was to operate through Local Authorities. This has so by 1965 in accordance with Government policy¹²⁴⁸.

“For some years it has been the policy of Government to encourage local authorities voluntarily to assume responsibility for water undertaking within their areas. Progress in this respect has been slow, mainly because local authorities have been reluctant to assume this responsibility unless it could be shown that the project was profitable or likely to be so in the near future”.

By May 1963 two County Councils, five municipalities and 29 African district councils had taken over or developed their own water undertakings¹²⁴⁹.

Rural Water Grant funds were made available to Local Authorities (formerly African District Councils) in three ways¹²⁵⁰:

By outright grant, as in the case of poorer councils such as Turkana.

1247 Director, Water Development Department (1965). Rural Water Policy. Water Development Department. Nairobi.

1248 Director, Water Development Department (1965). Rural Water Policy. Water Development Department. Nairobi.

1249 Director, Water Development Department (1965). Rural Water Policy. Water Development Department. Nairobi.

1250 Director, Water Development Department (1965). Rural Water Policy. Water Development Department. Nairobi.

On a £ for £ basis, the Local Authority first producing all the money for an approved scheme and then, reimbursing half the total cost if the scheme was completed to the satisfaction of the Rural Water Adviser. The reasoning behind this was that where local people were compelled to meet part of the cost of a scheme they would feel much more inclined to take an interest in its upkeep and maintenance.

Part grant, part loan; e.g. in a scheme costing £9,000 it might be decided to make a £3,000 grant to a Local Authority once it is applied for and is allowed to take up a £6,000 loan. The proportions might vary but the principle remains the same. This principle was applied to the wealthier Councils.

Such a criterion, however, would be most difficult to apply when the merits of plans in the low-potential and arid areas are considered individually¹²⁵¹.

The 1965 financial retarded development and also led to a break-down in many areas of the maintenance of existing supplies. Two specific cases in this respect were noted, that of the boreholes at Kwale and that of a number of small dams in Baringo in connection with grazing control schemes. In both cases Central Government grant funds were fully involved and considerable correspondence was passed between the Ministries concerned. No doubt there were many more cases in addition to the two referred to above. As the result of these experiences the Treasury recommended that¹²⁵²:

“No Government money in the form of grants or loans should be made available for water supplies to any Local Authority which was unable to satisfy the Director of Water Development that existing water supplies were being well maintained, that adequate funds were available for renewals of already existing water supplies for which the Local Authority was responsible and that proper renewal provision would be made for the new scheme¹²⁵³.”

The Ministry of Local Government accepted this recommendation and it was suggested that in the case of a breakdown of a Local Authority's supplies the Director of Water Development should be empowered to effect the necessary repairs. The cost was to be recovered from the Local Authority through the Ministry of Local Government on condition that there were adequate financial arrangements.

The provision of piped water supplies was considered of an inestimable value to the economy of the country and the general well-being of the people. Nevertheless,

1251 Director, Water Development Department (1965). Rural Water Policy. Water Development Department. Nairobi.

1252 Director, Water Development Department (1965). Rural Water Policy. Water Development Department. Nairobi.

1253 Director, Water Development Department (1965). Rural Water Policy. Water Development Department. Nairobi.

it was this Ministry's belief that Councils had a duty to their people to present the financial implications however unpalatable they could be. The need to provide water at reasonable terms was felt though in the final analysis, the success of any of these ventures was dependent on the willingness of consumers to pay promptly with the least possible use of coercion by Local Authorities.

A specific introduction in the above mentioned Local Government circular was that water rates would not be used in the general services of the Council concerned but will be applied exclusively to the provision and development of water supplies. However, only in very few cases were the Local Authorities successful in collecting water rates. Having to pay for water was an unpopular move and the bulk of County Councillors did not appear to wish to make themselves unpopular by forcing water rates upon their people. The result was that the Councils were not able to build up maintenance organisations or renewals funds and that repayment of loan monies had to be made out of general revenue¹²⁵⁴.

Non-Gazetted Water Supplies Funds: Water supplies to the smaller administrative boma such as Lodwar and trading centres attached thereto were treated under the above heading. A Small amount of funds barely adequate for the purpose was made available each year to operate and maintain these supplies. Without a substantial increase in the voted provision, it was impossible to accept any other additional supplies under this heading. However, any extension of water supplies to small trading centres throughout the country was to be financed from a provision under this head. It was not possible to consider them as public water supplies in the accepted sense, because they were not economically viable and were be subsidised by other water supplies with a consequent increase in rates generally throughout the country¹²⁵⁵.

Dam Subsidies: The granting of subsidies for the construction of storage dams for agricultural purposes was covered by Gazette Notice No 3780 on 10th November 1964. In general terms, subsidies were payable up to £1,900 in low rainfall areas ad £1,200 in high rainfall areas where the Agricultural Committee had certified that the dam was necessary for the full economic development of the holding¹²⁵⁶.

1254 Director, Water Development Department (1965). Rural Water Policy. Water Development Department. Nairobi.

1255 Director, Water Development Department (1965). Rural Water Policy. Water Development Department. Nairobi.

1256 Director, Water Development Department (1965). Rural Water Policy. Water Development Department. Nairobi.

Institutional Water Supplies Funds: These were funds supplied by the Ministry concerned for the operation and maintenance of water supplies to such institutions as Government schools, agricultural training centres, police stations, administration boma, etc. Where a new institution was set up, the water supply installation was treated as an integral part of the cost of the works. Funds were made available to this Department by the Ministry concerned to enable the installation to be effected. In too many cases also, an Institution was planned and it was only afterwards that the Water Department was asked to consider a potable water supply installation¹²⁵⁷.

Range Water Supplies: Financial provision for water supplies in connection with range management grazing control schemes was made in the Ministry of Agriculture estimates. It was considered to be right and that no change in policy was required. Basically dams, pipelines and boreholes in connection with Range Management Schemes were just as much part and parcel of these schemes as were fencing, dips, cattle watering points, etc. and subject to discussion with this Department on technical aspects, the policy as to which schemes were proceeded with, etc. rested with the Ministry of Agriculture, and the Water Development Department was merely the agent of that Ministry¹²⁵⁸.

Agrarian Loans for Community Projects: These loans were related to the Water Supply Grants provision, to Range Water Supplies and to Rural Piping Schemes where the financial arrangements were part grant, part loans¹²⁵⁹.

Settlement Scheme Water Supplies: In 1967 the Deputy Director of Settlement reported that in order to meet the terms of loan from IBRD/CDC to Kenya Government, it was essential that the installation of reticulated water supplies be complete by June, 1967. The said programme involved installation of supplies in over 180,000 acres to some 5,000 settlers. Already much of the work had been done and it was obvious that the remaining work could not be completed by June, 1967 without an increase in qualified technical officer¹²⁶⁰. Table 3.62 shows the scope of

1257 Director, Water Development Department (1965). Rural Water Policy. Water Development Department. Nairobi.

1258 Director, Water Development Department (1965). Rural Water Policy. Water Development Department. Nairobi.

1259 Director, Water Development Department (1965). Rural Water Policy. Water Development Department. Nairobi.

1260 Burke V E M (1967) Water Schemes on IBRD/CDC Settlement Scheme. Kenya National Archives. AVS/6/8 Ref DS 8 Vol 4/5 4th April, 1967.

the problem and progress that had been made up to June 1969 while Table 3.63 is the summary of water schemes¹²⁶¹.

Table 3.62: Settlement schemes supplies as at June 1969

Scheme	Acreage	Number of plots	Progress made up to June 1969
Passenga	4774	125	Completed or installation in progress
Silanga	3890	89	"
Kikuyu Estate	624	38	"
Lessos	5679	130	"
Keben	3716	147	"
Koylat	4749	88	"
Lietego	1705	54	"
Anabkoi East	5846	142	Design and estimates complete
Anabkoi West	6291	144	"
Anabkoi North	4017	89	"
Timboroa	3067	64	"
Gelegele	3653	109	"
Nyairoko	4913	99	"
Kanyagia	3836	100	"
Simbara	4272	81	"
Ndaragwa	5744	121	"
Pesi	4958	89	"
Chepsir	4870	35	Work not started
Sotik North	2888	107	"
Mwangori	4381	105	"
Matutu	5783	179	"
Nyansiongo	5437	142	"
Gesima	5503	226	"
Koyet	3797	94	"
Oraimutia	7268	169	"
Matindiri	6541	126	"
Upper Gilgil	5376	111	"
Gilgil West	6531	132	"
Oi Kalou South	7136	140	"
Ndalu	8277	191	"
Nzoia	7709	170	"
Mabusi	5120	129	"
God Abuoro	5930	319	Design and estimates to be revised
Muhoroni	8133	486	"
Tamu	6098	422	"
Totals	178,512	4992	

1261 Burke V E M (1967) Water Schemes on IBRD/CDC Settlement Scheme. Kenya National Archives. AVS/6/8 Ref DS 8 Vol 4/5 4th April, 1967.

Table 3.63: Summary of the water schemes

Summary	Acres	Plots
Completed or installation in progress	25,137	671
Design and estimates complete	46,597	1,038
Work not started	86,617	2,056
Design and estimates to be revised	20,161	1,227
Total	178,512	4,992

Engineering staff and water bailiffs from the water organisation were seconded to the Ministry of Lands and Settlement for the design of settlement scheme water supplies sometime after the operation had begun. This was one of the reasons why it was not satisfactory. The designs turned out have been considered to be too sophisticated and expensive for a new rural community striving to establish itself. It was a policy of the Settlement Ministry that all water provided for settlement schemes should be paid for ultimately by the beneficiaries. In addition, carrying out work on behalf of Settlement utilized the Rural Water Staff who would have been engaged on rural development in various areas throughout the country¹²⁶². The staff also included 8 Peace Corps Volunteers, who were mainly involved in the installation of the scheme. However, some of them could have been diverted to perform survey and estimates work if only this could not call for greater supervision than was provided¹²⁶³. It was suggested that two more technical officers were required for this purposes and it was suggested that the two officers be seconded to the department of settlement¹²⁶⁴.

In 1967 a survey was done at Nyandarua School by the Hydraulic Engineer and it was found that the school drew its water from a borehole. This borehole belonged to Settlement Fund Trustee which produced approximately 1,818.4 litres per hour (400 gallons) per hour which was inadequate for the proposed project as it required 68190 to 909200 litres per day (15,000 to 20,000 gallons per day)¹²⁶⁵.

It was also reported that there existed an excellent gravity supply pipeline which was situated high above the site of the school and Ol Kalou West Scheme. The nearest connection site was about 8,000 feet away from the site. This water supply was about to be owned by the Ol Kalou West Co-operative Society and it was suggested

1262 Director, Water Development Department (1965). Rural Water Policy. Water Development Department. Nairobi.

1263 Burke V E M (1967) Water Schemes on IBRD/CDC Settlement Scheme. Kenya National Archives. AVS/6/8 Ref DS 8 Vol 4/5 4th April, 1967.

1264 Burke V E M (1967) Water Schemes on IBRD/CDC Settlement Scheme. Kenya National Archives. AVS/6/8 Ref DS 8 Vol 4/5 4th April, 1967.

1265 Shelat P C (1967) IDA Education Project Nyandarua Secondary School-Rurii Township. Kenya National Archives. AVS/6/8 Ref DS.8/Vol 4/25 5th July, 1967.

that agreement be made with the Co-operative Society in order to get a connection from the nearest point from the system. The school was to buy and install its own piping and fittings¹²⁶⁶.

The school could then be charged shillings 1/80 per 4,564 litres (1,000 gallons) of water. It was further reported that the source of water to the said system was from 22.73 million litres (5 million gallons) dam above the Ol Kalou West Scheme, the water was fairly clean¹²⁶⁷.

Inspecting and Testing

The assistant hydraulic Engineer reported that all pipes, fittings and appliances should be inspected on delivery to the site to see whether they bear, where appropriate, the proper testing mark. The inspection and testing should be as follows¹²⁶⁸.

Mains

Where possible the mains were supposed to be tested hydraulically under pressure equal twice the maximum permissible working pressure while piping and fittings were to be inspected on site before laying and were to be sounded to disclose cracks. Any defective item was to be marked rejected and thereafter removed from the site. After laying and joining, the main was supposed to be slowly and carefully charged with water so that all air was expelled from it. They would then be permitted to stand full of water for some days, and the tested under pressure. Pressure testing could be done manually operated pump or power driven pump in case of long mains of large diameter. Where pressure testing pump were used, pressure gauges were to be accurate and preferably recalibrated before test. If the section of main terminated with a sluice valve the wedge of the pump was not to be used to retain the water. And instead the valve was supposed to be with a blank flange or if socketed valve, plug, and wedge was supposed to be placed in an open position while testing¹²⁶⁹.

Services

On completion, the service was supposed to be charged with water and when all draw-off taps were closed the service was to be absolutely watertight. In addition, each tap was to be opened and tested for rate of flow, and all piping, fittings and

1266 Shelat P C (1967) IDA Education Project Nyandarua Secondary School-Rurii Township. Kenya National Archives. AVS/6/8 Ref DS.8/Vol 4/25 5th July, 1967.

1267 Shelat P C (1967) IDA Education Project Nyandarua Secondary School-Rurii Township. Kenya National Archives. AVS/6/8 Ref DS.8/Vol 4/25 5th July, 1967.

1268 Ombewa Martin Odul (1967) Development of Water in Settlements Schemes. Kenya National archives. AVS/6/8 4th October, 1967.

1269 Ombewa Martin Odul (1967) Development of Water in Settlements Schemes. Kenya National archives. AVS/6/8 4th October, 1967.

appliances were to be checked over for satisfactory support and protection from damage, corrosion and frost. Further because of the possibility of damage in transit cistern were supposed to be tested for water tightness on arrival on the site before fixing¹²⁷⁰.

Main-laying

The bottom of the excavated trenches was supposed to be carefully prepared so that the barrels of pipes when laid are well bedded down for their whole on a firm surface and are true to rain and gradient, their width was also supposed to be of sufficient width to allow for proper laying and joining of pipes. While filling the trenches fine selected materials were to surround the pipes so as prevent subsequent movement of the pipes. The pipes were also to be cleared of any foreign matter before they are laid and after laying, the open end was to be temporarily plugged to prevent access of water or soil. In a case there was a gradient, pipe laying was to proceed in an uphill direction in order to facilitate joint making. Where necessary concrete chambers were to be provided to give access to valves and hydrants¹²⁷¹.

Mechanical Trenching Equipment

In 1968 the Assistant Hydraulic Engineer was authorised to look into obtaining a sort of mechanical trenching equipment and he got the Arps Trench Hog machine. This kind of machine was all what the distributors in Kenya could be able to import as there was none Kenya at that moment. One had to be imported on receipt of an order. It was further reported that this type of machine had never been used in Kenya before¹²⁷². He further said that from the information he had acquired from the manufacturers it seemed that this type of machine was what they were looking for and he recommended that they purchase one and do some field-testing. The suppliers were to back the machine to make sure that everything operated smoothly but they could not guarantee it against breakdown arising from negligence on the user's part. The guarantee could cover any modifications that could have been done on the machine to overcome some conditions in Kenya for which the machine was not designed to encounter¹²⁷³.

1270 Ombewa Martin Odul (1967) Development of Water in Settlements Schemes. Kenya National archives. AVS/6/8 4th October, 1967.

1271 Ombewa Martin Odul (1967) Development of Water in Settlements Schemes. Kenya National archives. AVS/6/8 4th October, 1967.

1272 Spore Arthur L (1968) Mechanised Trenching Equipment. Kenya National Archives. AVS/6/8 5th January, 1968.

1273 Spore Arthur L (1968) Mechanised Trenching Equipment. Kenya National Archives. AVS/6/8 5th January, 1968.

The price given by the distributor on the trench with a 3 ½ ft. boom equipped with a chisel cutter was 5,000 pounds or 35,000/-Kenya shillings. This was inclusive of the necessary kit to amount it on any standard agriculture tractor¹²⁷⁴.

Agricultural Finance Corporation Loans for Boreholes: This was another source of fund for rural water development which was not controlled by the same Ministry. Any farmer who could convince the relevant authorities as to his loan-worthiness could obtain a loan from the Agricultural Finance Corporation for the sinking of a borehole. The loan was subject to the approval of the Central Agricultural Board which made recommendations to the Agricultural Finance Corporation. There was no need to make policy change in this set-up. Government was recommended to exercise the right to check and inspect a scheme involving water development should this appear necessary at any stage¹²⁷⁵.

UNICEF: This United Nations agency operated through the Ministry of Health and Housing and under the supervision of a resident World Health Organisation engineer. It provided imported materials for use in construction by locally employed labour (e.g. piping, cement, pumps, etc.). This work was usually on a £ for £ basis in co-operation with the Local Authority¹²⁷⁶.

In the field it was supervised by Health Inspectors and not by Water Development department. The situation was challenged by lack of engineering experience in the valuable work which Health Inspectors did in protecting springs and wells. A change in policy was needed and UNICEF was required to consult with the Water Development Department with regard to the programme to be followed as far as water supplies were concerned¹²⁷⁷.

Methods of Collection of Water Rates: The Water Development Department was convinced that people had to pay for water-there was no such a thing as free water. That people were supposed to pay according to their ability even through an only a small amount. The Minister had put across this message at Kitui and some wholly admirable publicity resulted¹²⁷⁸.

1274 Spore Arthur L (1968) Mechanised Trenching Equipment. Kenya National Archives. AVS/6/8 5th January, 1968.

1275 Director, Water Development Department (1965). Rural Water Policy. Water Development Department. Nairobi.

1276 Director, Water Development Department (1965). Rural Water Policy. Water Development Department. Nairobi.

1277 Director, Water Development Department (1965). Rural Water Policy. Water Development Department. Nairobi.

1278 Director, Water Development Department (1965). Rural Water Policy. Water Development Department. Nairobi.

Normal methods of collecting water revenue (e.g. individual metres or from water kiosks) did not work in rural areas. Metres were expensive to install and were stolen or tampered with too easily. In periods of wet weather, water was drawn from temporary pools, or even from rivers, and revenue from kiosks, apart from general supervision difficulties, was unreliable. It was clear that there was no readily workable method by which those who benefited from existing water installation could be made to pay and that the only way of arriving at payment for water is by a general levy¹²⁷⁹.

One possible way of doing this was the hypothecation of a portion of cesses on agricultural production, however, government policy was moving away from cesses of this nature. In any event, the amount of revenue produced from cesses, particularly in the areas of widely varying rainfall varied considerably from one year to another depending on whether the crops were good or not. The only practicable way of raising revenue was hypothecation of a portion of Graduated Personal Tax which had to be increased accordingly. The challenge was that this levy varied depending on whether the area concerned was of high or low potential¹²⁸⁰.

In the case of new development at Central Government expense in areas where there was individual title and the installation of a water scheme clearly benefited individuals as opposed to the community and increased the value of their holdings, then the individuals concerned were supposed to pay the economic cost of the water supplied. The most effective way of ensuring payment was to assess the value of the water supplied to each holding per annum and to have an annual charge for water written into the lease. In areas where land was freehold, the problem was more complex and the only practicable way of ensuring repayment was by an “additional benefit” levy on Graduated Personal Tax. This was possible through the increased “average annual value of holding” which would result from the installation of the works. However, this increase was less than the economic cost of water supplied in the year.

A general levy for the establishment of a fund for rural water development purpose was recommended. The only practicable way of achieving this was by a hypothecation of a proportion of GPT which would probably had to be raised accordingly. Where a particular water supply benefited a number of individuals as distinct from the community, then these individuals had to meet the cost of this additional benefit whether by a charge written into the lease or by other means. Where charges were raised in connection with rural piping schemes, etc., these

1279 Director, Water Development Department (1965). Rural Water Policy. Water Development Department. Nairobi.

1280 Director, Water Development Department (1965). Rural Water Policy. Water Development Department. Nairobi.

charges were supposed continue for all time to enable the works to be maintained and replaced when worn out¹²⁸¹.

Division of Responsibility between Central Government and Local Authorities:

The existing financial position of most local authorities was low and the Central Government was expected assume greater responsibilities if rural water development was to make any progress at all. Under the rural piping schemes, those future loans were expected to be managed by Government preferably through the proposed National Water Authority. However, apart from the financial position, there was also the lack of interest by Local Authorities in water development and the lack of priority given to water schemes. The then series of articles in the East African Standard which appeared to be fairly authoritative gave the following information on (Table 3.64) the allocation of the funds available to one particular Local Authority in 1964¹²⁸²:

Table 3.64: Responsibility between the national and Local Authorities

Responsibilities of Local Authority	Priority (%)
Education	50
Health	14
Administration	14
Roads	9
Community Development	2
Agriculture, Veterinary and Forestry	2
Total	91

Water development did not feature on the list of items at all. In this connection a measure of direction from the Central Government was required¹²⁸³.

It was recommended that the present policy of delegating responsibility to Local Authority for water supplies in their rural areas should be modified and subjected to a financial ceiling. This required the approval of the Ministry of Local Government. It was recommended that schemes of a value less than £5,000 should remain with the Local Authority and that the Water Development Department's staff in rural

1281 Director, Water Development Department (1965). Rural Water Policy. Water Development Department. Nairobi.

1282 Director, Water Development Department (1965). Rural Water Policy. Water Development Department. Nairobi.

1283 Director, Water Development Department (1965). Rural Water Policy. Water Development Department. Nairobi.

areas should be increased so as to give more support to the Local Authorities. This staff must not be placed under the control of the Local Authorities¹²⁸⁴.

Except where the Local Authority proved itself, in the opinion of the Director of Water Development competent in water matters, individual projects costing more than £5,000 were supposed to remain a full Central Government responsibility from the point of view of planning, construction and financial arrangements. The above implied a division of the hypothecated portion of GPT between the Local Authority and Central Government¹²⁸⁵.

Rural Water Piping Schemes: A policy decision was required on settlement schemes about the role of government in order to charge less for water in areas such as the Kinangop in order stimulate the demand and to ensure that Central Government funds spent on these pipelines in the past were not wasted¹²⁸⁶.

On schemes in the old non-scheduled areas, no policy change is recommended except that in view of the financial state of many local Authorities the most suitable authority to administer loans for rural water development was the proposed National Water Authority. Piping schemes were proposed to remain the property of the Government through the National Water Authority. A policy decision however was again required as to the extent to which Government would wish initially to subsidize the cost of water to the rural consumer (if at all), for example by loans on easier-than-normal terms to the National Water Authority¹²⁸⁷.

Water Use Policy: Water use policy has five dimensions; these are: (1) Who should manage and control the water scheme;(2) How should water use be controlled so that it was not wasted, and the distribution is fair and what uses of water are acceptable;(3) How the scheme should be managed so that almost all of the resident population receives water from the schemes;(4) What level of costs should be recovered in a tariff system?; and (5) What are appropriate of administrative rules to govern the operation of water use policy¹²⁸⁸.

1284 Director, Water Development Department (1965). Rural Water Policy. Water Development Department. Nairobi.

1285 Director, Water Development Department (1965). Rural Water Policy. Water Development Department. Nairobi.

1286 Director, Water Development Department (1965). Rural Water Policy. Water Development Department. Nairobi.

1287 Director, Water Development Department (1965). Rural Water Policy. Water Development Department. Nairobi.

1288 Ministry of Water Development (1983). Water Use Study, Main Report, 1983.

In January 1963, the Ministry of Local Government issued a wholly admirable memorandum to African District Council which stated¹²⁸⁹:

“The provision of piped water supplies is of inestimable value to the economy of the country and the general well-being of the people. Nevertheless, it is this Ministry’s belief that Councils have a duty to their people to present the financial implications, unpalatable though these may perhaps be. It is by the very reason of things that water, so often in the past as a bounty, cannot be provided free of cost to the consumer. Constant thought is being given to the problem of providing water supplies on the most reasonable terms but in the final analysis, the success of any of these ventures will be dependent on the willingness of consumers to pay promptly with the least possible use of coercion by Local Authorities.”

A specific introduction in the above mentioned Local Government circular was that water rates will not be used in the general services of the Council concerned but will be applied exclusively to the provision and development of water supplies. However, in very few cases indeed did Local Authorities appear to have been particularly successful in collecting water rates nor, indeed, did they appear to have made much effort in this respect. Having to pay for water was an unpopular move and the bulk of County Councilors did not appear to wish to make themselves unpopular by forcing water rates upon their people.

The result was that the Councils had not been able to build up maintenance organisations or renewals funds and that repayment of loan monies had had to be made out of general revenue. It was understood from the Ministry of Local Government that in General terms loan repayments were being met by Local Authorities, but out of general revenue and not because of water rates collected. While it had to, be accepted that in poorer areas people were unable to pay much for water, in many of the higher potential areas people had the capacity to pay and it was reasonable that they should make a contribution for the services they receive¹²⁹⁰.

The Kinangop Ring Main however had not at any time produced sufficient revenue to meet loan charges. Future repayments as settlement schemes increased and large farms changed from European to African ownership was an unpredictably challenging ¹²⁹¹:

1289 Hukka J and T Katko and O Seppala (1992), Kenya Water Sector-A Position Paper, Tampere University of California Press, Berkeley.

1290 Director, Water Development Department (1965). Rural Water Policy. June 1965.

1291 Director, Water Development Department (1965). Rural Water Policy. June 1965.

The recommended principles of water use policy by the MoWD were as follows¹²⁹²:

- The operation, augmentation and management of water supplies were supposed to be decentralized. The ministry of water development to divest itself of water supplies as quickly as could be done in a sensible manner.
- The water supply to seek to reach a minimum of 80% of the population within the area of service of MoWD's water supplies and the objective was supposed to provide water to 90% on the average. This contrasted with the existing level of 35% of the population in the area served, thus design and operation were supposed to be directed towards this objective.
- The rural water supplies was supposed to, with immediate effect recover 100% of the operations and maintenance costs, including MoWD overheads. Capital cost recovery for replacement and augmentation be initiated by 1988 and full recovery of capital costs be achieved by 1993.
- Minor urban water supplies were recommended recover 100% of all costs including MoWD overheads with immediate effect. Town councils be free to set their tariffs but the principles should follow those set herein. In particular the Councils were supposed to not use water sales as a source of general revenue.
- The water supply sector had to have the objective of being financially independent of general government by 1993 and able to finance both operations and maintenance and scheme augmentation from recovered revenues. The MoWD would continue to be responsible for facilitating the financing of new scheme construction.
- It was recommended that water use policy should be flexible and should conform to the particular problems of an area or region. In particular the remote, low potential areas had to be treated differently than the high potential areas.
- Provision of water in rural areas was supposed to be in addition to water for the household and animals include allowance for garden irrigation should the user wish. Generally this was expected to prove too expensive but for vegetables and fruits watered by hand there were useful improvements in food production for sale or own consumption that could be economical.
- Revenue collections should be targeted at 85% of billings whereas; water sold should be targeted at 85% of water produced.
- Operations of water supply should be economical and efficient with no employment of staff above what was required for the water supply's operation.

1292 Ministry of Water Development (1983). Water Use Study, Main Report, 1983.

Water use policy in high potential and low potential areas: The basic water use policy within high potential areas was to increase the number of individual connections. In these areas most farmers own their own plots and there was every reason to encourage the increase of individual connections on farms, while simultaneously ensuring that landless households had access to the scheme. The policies that could support the increase of individual connections included; loans to household to finance, correct design criteria, improved operations and maintenance and the District Water Officer was recommended to be more aggressive in marketing this scheme.

In the low potential areas where land holdings were often based on traditional rights and title deeds had not yet been established, there was low willingness of households to invest in water connections. There are two approaches toward the overall policy, these were: in the more urbanized settlements or where title deeds had been issued the policy of individual connection should be encouraged. Whereas in rural areas with low population densities MoWD should shift its emphasis to point sources with relatively low levels of service¹²⁹³.

Water, community well-being and public policy: While dealing with supplies pumped directly into households, it was common for public bodies to apply two general policies in towns. First, it was assumed that the population which could afford to pay for house connections should be enabled to use as much water as it wished at a cost sufficient to return the public outlay for construction, operation, and maintenance. Second, it was required that the cash revenues from either metre or flat rates pay off the total investment in construction and maintenance. This policy was not in force everywhere, and to the extent that less than the direct outlay was recovered, the difference represented public subsidy. To the extent that revenues exceed costs, the water enterprise became a different form of taxation.

National water improvement decisions inevitably were linked with other policy considerations. New domestic supplies in arid area were expected to stimulate increased livestock production and range deterioration. Improvements in rural district could be viewed as stemming migration to the cities, whereas urban improvements could be contingent upon developing adequate supplies. Water supply and waste disposal were traditional alternatives to health service investments¹²⁹⁴.

A very important policy directive, which had effect on the water sector was the Presidential Directive of April, 1981 that revised the then existing rural tariffs on account of (a) abolishing temporary metered rural tariffs, and (b) unified official

1293 Ministry of Water Development (1983). Water Use Study, Main Report, 1983.

1294 Gilbert F. White, David J. Bradley and Anne U. White (1972). Drawers of Water, Domestic Water Use in East Africa. The University of Chicago Press Chicago and London, 1972.

rural tariffs throughout the Country in place of the then existing geographically different tariffs. This directive started off the direct involvement of politicians in dictating the policy in the water sector. Indeed the bureaucrats then got scared of revising even the urban tariffs such that the legal Notice No. 94 of 1975¹²⁹⁵ for urban water schemes but set in 1977 remained unchanged for fifteen years.

Thus, the sustainability of urban water supplies was affected directly. The overall long-term objective of achieving self-financing for the water sector; through the policy full cost recovery for urban schemes was thus defeated. In the same breadth the policy of recovery of the direct operation and maintenance costs for rural water supplies was also jeopardized. The Ministry of Water Development, not only standardized the tariff throughout the Country, but also almost abolished metered connections in rural areas.

Therefore, the policy of ability to pay in different parts of the Country that had been expounded in the development plan was not strictly adhered to (Legal notice No.194, December 1981)¹²⁹⁶. Whereas the Fifth development plan (1983-1988) reverted to theme of the third development plan, as far the policy on water was concerned; the legal notice no.194 of 1981 was not withdrawn. It is interesting to note that this legal notice was not revised till 1992, in spite of even the publication of the Governments Sessional paper No.1¹²⁹⁷ that introduced cost recovery in provision of social services.

In 1982, the District Focus strategy was marked by a presidential directive. In 1983, the District Focus for Rural Development policy was promulgated by the government whose intention was to decentralize planning and administration for multi-sectoral development to the district level. This had an initial benefit as decision making cycles were reduced from national to district level, but capacity problems in financial monitoring, created unforeseen bottlenecks, with endless exercises of national financial transaction reconciliation based on both headquarter and district based documents. By 1985, the strategy was rationalised as follows¹²⁹⁸:

- 1) The people would be directly involved in the identification, design, implementation, and management of projects and programmes. This would make the development more consistent with the needs and aspirations of Wananchi.

1295 Republic of Kenya (1975). Kenya Gazette supplements No 39, Legislative supplement No 28, Water Act Cap 372. The Water (Water Development department) (Tariff) regulation. Government printers.

1296 Republic of Kenya (1981). The Water Act Cap 372. The Water (Water Development Department) (Tariff) (Amendment No. 2) Regulations. Legal notice No. 194. 1981.

1297 Republic of Kenya (1986). Sessional Paper No.1. Economic Management for renewed Growth. Government Printers, Nairobi.

1298 Alila, P.O (1988) Rural Development in Kenya: A Review of Past Experience. PP. 152-165) in Regional Development Dialogue. Vol. 9, no.2. Nagoya: UNCRD

- 2) The decision-making structure would centre on the districts themselves. This would minimise the delays that often characterise centralised decision-making systems.
- 3) Equitably, resources would be directed to areas of most need. In later years, the operations of the DDC were modified by introducing a District Executive Committee (DEC), consisting of the DC, the DDO, departmental heads of ministries represented in the district, clerks of local authorities and representatives of development-related parastatals. The office of the DDO was also strengthened by the establishment of a District Planning Unit.

In 1986, the Government launched Sessional Paper No.1 of 1986 on Economic Management for Renewed Growth. Under this new policy, the Government was to address strategies for provision of basic services which would accelerate economic growth and reduce inflation¹²⁹⁹.

In 1992, the Ministry of Water Development released two important documents that continued to guide the sector up to the end of the decade. One was the Delineation Study: The Water Sector in Kenya and the National Water Master Plan¹³⁰⁰. The main outcome of the delineation report was a defined and improved delineation of roles, functions and responsibilities of the principal actors in the sector, with special focus on those roles, functions and responsibilities which best suited the MoWD and NWCPC.

On the other hand, the National Water Master Plan set out long-term plans for the much-needed reforms in the management and development of the water sector. One of the most important recommendations to come from the two reports was that the Ministry should develop a water policy.

The National Water Policy: Between 1995 and 1999, the ministry was involved in a policy development process for the sector. This was published as Sessional Paper No. 1 of 1999 under the title “National Policy on Water Resources Management and Development”¹³⁰¹. The National Water Policy was stipulated in Sessional paper No.1 of 1999, and it covered issues relating to water resources management, water supply and sewerage development, institutional framework and financing of the

1299 Republic of Kenya (1986). Sessional Paper No.1. Economic Management for renewed Growth. Government Printers, Nairobi.

1300 Japan International Cooperation Agency (1992). The study on the National Water Master Plan. Ministry of Water Development. January 1992. Nairobi, Kenya.

1301 Republic of Kenya (1999). Sessional Paper No. 1 of 1999 on National Policy on Water Resource Management and Development. Government Printers, Nairobi.

water sector. With regard to WSS, the policy provided a reevaluation of respective roles of the key actors in the WSS sector¹³⁰².

This document was the blue print that guided legal, administrative and investment reforms in the water sector. The document also proposed the necessary framework and provided a mechanism for mobilising resources to safeguard and develop the Country's water sector.

The delay in publishing the document implied that the policy did not capture the emerging trends in the water sector that were fast gaining pace such as commercialisation. The policy spelt out the need to decentralize the decision making in the water sector, but failed to clearly explain where the services would be decentralized. Though the policy stated that urban water supplies would be handed over to Local Authorities with adequate capacity, no specific moves were made to build the capacity in the Local Authorities. Therefore, as proposed in the document a new legal framework to back up the new policy directions had to be developed.

Prior to the launching of the National Water Policy, the sector had been steered through strategies that often resulted into unsustainable water utilities, and ultimately, poor service. The policy paper was specifically meant to deal with the following issues:

- Water resource management; water supply and sewerage development; institutional framework; and financing of the water sector.
- Propose institutional reforms that separate water resources management from water services provision.
- Outline separation of policy, WSS regulatory board and implementation functions within the sector.

Following the National Water Policy that heralded a new era for the water sector, the ministry prepared the Country Strategy on Water and Sanitation Services that aimed to further develop the policy aspirations and define an implementation framework. The main problems facing water services delivery have tended to revolve around lack of clarity with regard to the institutional framework, un-sustainability of services and inadequate financing. The strategy was therefore, developed with a focus on specific roles of the various actors clearly defined in an institutional framework that underscored separation of service delivery from regulation¹³⁰³.

1302 Hukka J.J. and Katko P.S (2002). Water Privatisation Revisited-Panacea or Pancake: Public –Private Partnership in Water and Sewerage Services in Kenya- Nyangeri E.N. Tampere University of Technology, Finland.

1303 Ministry of the Environment and Natural Resources (2001). Country Strategy on Water and Sanitation Services. Final Draft Paper. Department of Water Development. September 2001.

Two key institutions to be established as part of this new framework were the Water Supply and Sanitation Services Boards and the WSS Regulatory Board that underpin this separation and ensures fair play among various actors. The new institutional framework also underscores the need to place water and sanitation services under single utilities in view of the close linkages in operations, maintenance and commercial aspects. This is in contrast to past practice where the two utilities were managed separately. The strategy emphasizes an increased role for the Private Sector in service delivery taking into account the need to ensure that the commercial principles that drive PSP do not undermine Government's aspirations as defined in the Poverty Reduction Strategy Paper by limiting access of the poor. The strategy emphasizes more than ever before, the role of communities in service provision by refining a framework that will enhance the communities' role, and access to finance as well as technical support¹³⁰⁴.

The role of the government was supposed to decrease in the director implementation of WSS projects, in provision of WSS services, and consequently there was an expected increase in community participation and the private sector. The policy required updating of the Water Act Cap 372, emphasized the need to develop sanitation in conformity with water ensure adequate cost recovery and to protect rural urban poor¹³⁰⁵.

The Country Strategy Paper for the Water Sector: The Department of Water Development of the Ministry of Environment and Natural Resources (MENR) was engaged in the preparation of a paper that was expected to explain the measures that were necessary to provide a legal and institutional framework that is, to achieve decentralization, to inject efficiency, and to increase sustainable access to improves WSS services. The paper recommended implementation of reforms in the water sector to facilitate better service delivery by making room for private sector players to supply water to consumers¹³⁰⁶.

Draft Water Bill 2000: In 2002, the MENR was in the process of finalizing the drafting of a new water bill, whose preparation was initiated before the strategy paper, which was why there were some discrepancies between the two documents.

1304 Ministry of the Environment and Natural Resources (2001). Country Strategy on Water and Sanitation Services. Final Draft Paper. Department of Water Development. September 2001.

1305 Hukka J.J. and Katko P.S (2002). Water Privatisation Revisited-Panacea or Pancake: *Public-Private Partnership in Water and Sewerage Services in Kenya-Dr. Nyangeri E.N.* Tampere University of Technology, Finland.

1306 Hukka J.J. and Katko P.S (2002). Water Privatisation Revisited-Panacea or Pancake: *Public-Private Partnership in Water and Sewerage Services in Kenya-Dr. Nyangeri E.N.* Tampere University of Technology, Finland.

With regard to the WSS service, the draft bill attempted to clarify the roles of various actors and new mechanisms which were to be put in place. However, the proposed bill as at July 2000 did not reflect the recommendations of the strategy document of the key issue of an independent regulator. The bill also provided too many opportunities for the Ministry to interfere in, and to delay and postpone the development of private projects and operations¹³⁰⁷.

Scope for Water Sector Improvement: In 1982, the ministry of water development realized the intricate position that was in as far as water supply was concerned. While the demand for water was constantly increasing, the fresh water resources were finite and the water quality, which was critical for multipurpose use was under threat. However, the water quality of the most major surface water bodies was still impaired in spite of the continuous discharges of effluent into the stream and rivers. The ministry of water development consequently initiated a “Water Quality Monitoring Program with objectives to¹³⁰⁸:

- Establish a network of water quality monitoring stations spread all over the major surface water resources;
- To collect water quality data from all the stations;
- To assess the impact on water resources from existing water pollution sources;
- To maintain a water quality data bank for use in planning and future development activities as well as for protection and conservation of water resources;
- To establish ambient water quality stream standards; and
- To establish a referral base for water quality changes viz-a-viz environmental impact of socio-economic development.

The initial stages were not successful mainly due to logistic problems as well as financial limitations, nevertheless implementation continued. The mode of operation recognized the need to select areas which were the major centres of economic development activities. These were urban areas and near lakes and ocean. These were, Lake Victoria drainage basin with 31 network stations on major rivers covering seven major rivers and an area of approximately 49,000km². The Rift Valley drainage

1307 Hukka J.J. and Katko P.S (2002). Water Privatisation Revisited-Panacea or Pancake: *Public –Private Partnership in Water and Sewerage Services in Kenya-Dr. Nyangeri E.N.* Tampere University of Technology, Finland.

1308 Hukka J.J. and Katko P.S. (2002). Water Privatisation Revisited-Panacea or Pancake: *Public – Private Partnership in Water and Sewerage Services in Kenya-Dr. Nyangeri E.N.* Tampere University of Technology, Finland.

basin-covering Turkwel and its tributaries, Ewaso Ng'iro south, Malewa, Gilgil and the Perkerra perennial streams covering an area of 127,000km²¹³⁰⁹.

Athi River Basin including the south coast drained approximately 70,000km² from several perennial rivers, the rivers drained very active, highly potential and urbanized region including Nairobi. Initially there were 86 networks but later reduced to 24 distributed among rivers major tributaries and in coast rivers. Tana River drainage basin covered an area of 132,00km² and drained 62,000km². The flow was contributed by 22 major tributaries draining the eastern slopes of Aberdares and southern slopes of Mount Kenya. There were twenty network stations¹³¹⁰.

Ewaso Nyiro drainage basin-north was the largest drainage basin covering an area of 205,000km². There were basically 5 perennial tributaries of the Ewaso Nyiro North draining the Northern slopes of the Aberdares, the Northern and western Slopes of Mt. Kenya and Northern Eastern parts of Nyambene range. The main River however, disappeared in a swampy expanse along its course in the arid north eastern region of Kenya. There were six network stations along the rivers and its tributaries¹³¹¹.

Lakes: There were eight major lakes under consideration viz; L. Turkana, Bogoria, Baringo, Nakuru, Elementaita, Naivasha, Magadi and Victoria, Amboseli, Solai, Jipe and Logipi¹³¹².

Ground water: There were about 10,000 boreholes and an intermediate number of shallow wells spread all over the country. However, the existing information on ground water quality was scanty and scattered.

Before 1984, the National Water Quality Monitoring Network program was organized, administered and implemented from the headquarters Nairobi. A team of three personnel used to cover all network stations taking water samples field measurements, and submitting the samples to the national water testing laboratory

1309 Hukka J.J. and Katko P.S (2002). Water Privatisation Revisited-Panacea or Pancake: *Public-Private Partnership in Water and Sewerage Services in Kenya*-Dr. Nyangeri E.N. Tampere University of Technology, Finland.

1310 Hukka J.J. and Katko P.S (2002). Water Privatisation Revisited-Panacea or Pancake: *Public-Private Partnership in Water and Sewerage Services in Kenya*-Dr. Nyangeri E.N. Tampere University of Technology, Finland.

1311 Hukka J.J. and Katko P.S (2002). Water Privatisation Revisited-Panacea or Pancake: *Public-Private Partnership in Water and Sewerage Services in Kenya*-Dr. Nyangeri E.N. Tampere University of Technology, Finland.

1312 Hukka J.J. and Katko P.S (2002). Water Privatisation Revisited-Panacea or Pancake: *Public-Private Partnership in Water and Sewerage Services in Kenya*-Dr. Nyangeri E.N. Tampere University of Technology, Finland.

Nairobi. In 1984, the functions of the Ministry of water were decentralized and consequently the operations of the network programme¹³¹³.

Development policies in Kenya have evolved substantially since independence in 1963 in response to national political priorities, donor pressure and policies and to the international political and economic climate. Numerous policy, regulatory and operational initiatives have been developed by the government and other stakeholders to address the key issues of growth, poverty and income inequality as sustainable poverty reduction requires a combination of growth and distributional policies. However, despite a generally positive policy framework the government has not succeeded in reducing poverty levels in Kenya as shown in Table 3.65¹³¹⁴.

Table 3.65: Percentage of population below the poverty line

Province	1982	1992	1994	1997	2000	2006
Central	26	36	32	31	32	30
Coast	55	43	56	62	70	70
Eastern	48	42	58	59	66	51
Rift Valley	51	51	43	50	73	49
North Eastern	Not available	Not available	58	Not available	Not available	74
Nyanza	58	47	42	63	71	48
Western	54	54	54	59	56	52
Nairobi	Not available	26	26	50	53	21
Rural	49	46	47	53	60	49
Urban	Not available	29	29	49	51	34
National	47	46	47	52	57	46

The Millennium Development Goals (MDGs)

Kenya, like the rest of Africa, recognises that the MDGs offer a great opportunity to address human welfare in the whole world and especially in the developing world. The adoption of the Millennium Declaration and the Millennium Development

1313 Hukka J.J. and Katko P.S (2002). Water Privatisation Revisited-Panacea or Pancake: *Public –Private Partnership in Water and Sewerage Services in Kenya-Dr. Nyangeri E.N.* Tampere University of Technology, Finland.

1314 Weir, A., Notley, M., and Katui-Katua M (2009). Impact and Lessons Learned. Evaluation, Finnish Aid in Western Kenya. Ministry of Foreign Affairs of Finland. Evaluation report 2009:5.

Goals (MDGs) by the United Nations Assembly in September 2000 was a laudable initiative by the international community to fight poverty, accelerate human development, and facilitate the gradual, but more effective integration of the developing world, especially Africa, into the global economy. The re-affirmation of the MDGs in subsequent international conferences was an additional indication of the commitment of the international community to attack poverty and inequality, and to end the marginalisation and exclusion of the poor and disadvantaged¹³¹⁵.

By 2004, evidence arising from the Needs Assessment Study in Kenya indicated that Kenya had great potential to meet these goals. Significant progress had been made towards achieving goals: (Achieve Universal Primary Education) and (Combat HIV/AIDS, Malaria and Other Diseases). As for the rest of the goals, the government was expected to scale-up efforts in order to implement the goals beyond the existing pace. A target for Millennium Development Goal 7 on environmental sustainability was “to halve by 2015 the proportion of people without sustainable access to safe drinking water and sanitation services”. Access to safe water was described as the percentage of the population with reasonable access to an adequate amount of water from an improved source, such as a household connection, public standpipe, borehole, protected well or spring or rainwater collection. Unimproved sources include vendors, tanker trucks and unprotected wells and springs. Reasonable access was defined as the availability of at least 20 litres a person a day from a source within one kilometre of dwelling.

Among the main synergies between the water and sanitation sector (WSS), were reduced incidence of water-borne diseases, empowerment of women and girls through savings on time and energy especially in provision of water, improvement in the living conditions in slum areas, business opportunities in the envisaged private sector participation (especially for women entrepreneurs in water and sanitation service delivery), and higher retention of girls in school due to improved provision of water and sanitation facilities. To achieve the MDGs in the water and sanitation sector, the people without access to safe water and improved sanitation needed to be halved, which translates to 80% nationwide coverage of safe water supply (urban 96% and rural 66%) and 96% coverage of improved sanitation (urban 96% and rural 89%)¹³¹⁶.

1315 Government of Kenya (2005). Millenium Development Goals in Kenya Needs and Costs. Report prepared by the Ministry of Planning and National development courtesy of UNDP Kenya and the Government of Finland. Harambee Avenue Treasury Building Nairobi.

1316 Government of Kenya (2005). Millenium Development Goals in Kenya Needs and Costs. Report prepared by the Ministry of Planning and National development courtesy of UNDP Kenya and the Government of Finland. Harambee Avenue Treasury Building Nairobi.

The Sessional Paper No. 1 of 1999 on National Policy on Water Resources Management and Development¹³¹⁷ and the Water Act 2002, guided the water resources management. The overall goal of the national water development policy was to facilitate the provision of water in sufficient quantity and quality and within a reasonable distance to meet all competing uses in a sustainable, rational and economical way. This policy separated policy formulation, regulation and services provision; defined clear roles for sector actors within a decentralized institutional framework; and included private sector participation and increased community development. This policy and institutional framework was expected to catalyse the achievement of the Millennium Development Goal. Rationale for Water Supply Technology Choice.

The rationale for water supply technology

The choice of water delivery technologies it was suggested should be guided by looking at the potential water sources in each district as documented in the National Water Master Plan Study of 1992. Several factors should be taken into consideration. First, although all Kenyans needed water, the scattered settlement pattern in the rural areas made the cost of universal household connections through piped schemes prohibitive. Therefore, where piped schemes were planned the proposed level of service was expected to be communal stand posts. Secondly, in many districts, springs were the main source of water and most all the viable spring sites had been acquired especially in the densely populated areas. Development of point sources (e.g. boreholes and wells) was seen as appropriate for servicing scattered settlements, while densely populated slum areas with temporary dwellings were better served by public stand posts¹³¹⁸.

The financing strategy

Average annual development investment in water and sewerage systems between the year 2000 and 2005 was about \$35 million/year. Overall, during the nineties, about 62% of the development budget to the water sector was funded by the donor community, while about 38% was financed by general revenues of the Kenyan Government. The Ministry of Water and Irrigation proposes that financial resources to be used to attain the MDGs will come from the following basic sources: loans from development partners, grants from various sources, Government budget, Water

1317 Republic of Kenya (1999). Sessional Paper No. 1 of 1999 on National Policy on Water Resource Management and Development. Government Printers, Nairobi.

1318 Government of Kenya (2005). Millenium Development Goals in Kenya Needs and Costs. Report prepared by the Ministry of Planning and National development courtesy of UNDP Kenya and the Government of Finland. Harambee Avenue Treasury Building Nairobi.

Services Trust Fund, water revenues from operators, financing from private service providers, and community contributions through water user associations (WUAs). The financing requirements for the MDG based on the interventions in the MDG Generic Model will be KES 4.09 billion in 2005, 5.99 in 2010, and 7.46 in 2015, making a total of 65.33. In addition, the country-specific interventions would amount to KES 171.548 billion over the period. The average annual investment on the MDG Model interventions during 2005-2015 was estimated as KES 5.94 billion

It was recommended that in order to sustain the Millennium Development Goals, the government was to quickly implement the Water Act 2002. The service delivery institutions provided for in the Water Act were intended to provide service delivery with adequate autonomy to operate sustainable services. The government was expected to be committed to the achievement of the MDG by fulfilling its share of the resource requirements and attract donor support for the gap. Third, community involvement was an essential part of project formulation¹³¹⁹.

It was deemed very important that communities, especially women, were trained to equip them with the appropriate knowledge and skills for the purpose, and promote community-based water committees with clearly defined roles. The government was expected to encourage and support private sector participation and community management of services backed by measures to strengthen local institutions in implementing and sustaining water and sanitation programmes. In order to stem the existing trend of giving low investment priority to sanitation, there was a need to identify the factors that drive demand for improved sanitation. The lessons learned could be used to build strategies for marketing sanitation as a sustainable intervention for poverty reduction. Social marketing would communicate that people chose the kind of sanitation they want and are willing to invest in.

There was also a need to hasten the preparation of the Integrated Water Resources Management (IWRM) Plan to provide the framework for addressing the multiplicity of issues that arose in the Water and Sanitation Sector. Implementation of the IWRM plan was anticipated to form the basis for beneficial use of the water for both health improvement and income generation and hence poverty reduction¹³²⁰.

1319 Government of Kenya (2005). Millenium Development Goals in Kenya Needs and Costs. Report prepared by the Ministry of Planning and National development courtesy of UNDP Kenya and the Government of Finland. Harambee Avenue Treasury Building Nairobi.

1320 Government of Kenya (2005). Millenium Development Goals in Kenya Needs and Costs. Report prepared by the Ministry of Planning and National development courtesy of UNDP Kenya and the Government of Finland. Harambee Avenue Treasury Building Nairobi.

3.8.2 Water Legislation

Albeit many countries in the world had formulated and enacted Water Legislation by the turn of the century, Kenya did not in fact have any express Water Law until 1929. However, the existence of this Water legislation in other countries for example South Africa, Canada, Italy, Roman-Dutch, Alberta and British Columbia lend quite some useful information to the founding fathers of water legislation in Kenya. Some of the useful water legislation, which was in operation in the above named countries, is expounded in modern water Legislation by Sikes 1922¹³²¹.

The immigration of the Imperial British East Africa Company brought about the assumption that there existed no water legislation, simply because there existed no written rules. Rather than through kinship, socio-political age grade system or geographical territories (common water law), the responsibility of water supply was vested in one institution, the Hydraulic branch. This disorganized and made the socially accepted water controls and informal institutional structures insignificant.

The Crown acquired, through Indian Land Acquisition Act 1894 and an Order in Council 1898, all land in British East Africa apart from some coastal areas¹³²². The power to alienate land (waste or uninhabited land) was legalized by the East African (Lands) Order in Council of 1901 and passed by an Executive Council¹³²³. This was replaced with Crown Lands Ordinance of 1902, which contained the first water legislation enactment that only covered the issuance of water permits¹³²⁴.

The first municipal regulations were published on 16th April 1900. Under the power vested in Sir Arthur Hardinge who was to form a committee by nominating leading residents to assist him. In fifteen short clauses the regulations laid down the rules for the conduct of the committee and prescribed the method by which rates for lighting, policing and cleaning the town might be levied together with procedure of appeal against assessment. The committee obtained the town plan from the railways marked out plots and sought government's permission to cut jungle wood to build new shops. Two months after the committee started to work a hundred and twenty insanitary shacks were demolished and the first bazaar census was under way. In March committee entered into an agreement with one Buddah Din, a contractor, to clean, sweep and light Nairobi and to keep drains clear of rubbish¹³²⁵.

1321 Sikes (1922). *Modern Water Legislation*. Public Works Department, Nairobi. 1922.

1322 Lotte H (2006). *Moving the Maasai, A Colonial Misadventure*. Palgrave Macmillan, in Association with St Anthony's College, Oxford.

1323 Karuiki, K.P. (2005). *Ecological Discourse and Colonialism in Kenya, 1895-1963*. Master Thesis in General History.

1324 Sikes, H.L (1926). *Comments on the Lewis report on irrigation, water supplies for stock and water law*. Kenya National Archives, Ref: AG/43/87.

1325 James S (1950). *A Jubilee History of Nairobi*. Kenya National Archives. CUP: 307 .76SMA. 1950

The Water Ordinance 1929: The first water legislation was contained in Section 3 of the Crown Lands Ordinance of 1902 and only covered the issuance of water permits. In succession to this Ordinance the Water Rules of 1903 and later 1909 were formulated. The Crown Lands Ordinance of 1902 was repealed and re-enacted as the Crown Lands Ordinance of 1915. In this ordinance, two brief sections on water Legislation were included. The first, section 75, chapter 140 of the Laws of Kenya and the second, section 145, chapter 140 of Laws of Kenya. Section 75, denied the person buying, leasing or occupying Crown Land express right to the spring, river, lake or stream on such Land except in the case of abstraction for domestic use. Section 145 prevented the damming of spring, river, lake or stream on Crown Land acquired in the above-mentioned ways. The section also provided for the formulation of Rules on the issuance of Water Permits in case one desired to construct a dam¹³²⁶.

It was under this provision that the Crown Lands Water Permit Rules of 1919 were enacted, giving the Director of Public Works Department the power to consent or refute to permit the abstraction of water from spring, river, lake or stream. The rules also prescribed the Method of acquisition of a water permit¹³²⁷.

The above Legislation in lieu of water Governance proved very inadequate and efforts were made towards comprehensive water Legislation. The first was a solo effort by the then Director of Public Works Department Sir McGregor Ross. In 1916 the Government of the Colony of Kenya requested Sir Ross to prepare draft water legislation for the colony. He faced a number of challenges including the lack of town planning; however, he produced and presented a document, which later came to be known as the Draft Water Ordinance of 1916. It was not drafted into a bill probably due to World War I, which took precedence then¹³²⁸.

Mr. Sikes proceeded with the work left behind by his predecessor and being pretty knowledgeable in the matters of water Legislation, he revised the previous document and formulated another draft ordinance of 1921 and that of 1922. It was at this time that he also wrote and published a book entitled *Modern Water Legislation*¹³²⁹. He established that, although sections of Crown land Ordinances No. 21 of 1902 and No. 2 of 1915 and the ordinances under the latter Ordinance, relating to water, no legislation providing for the adequate control of water in the interest of the community had been enacted in Kenya by May 31 1921¹³³⁰.

1326 Sikes (1922). *Modern Water Legislation*. Public Works Department, Nairobi. 1922.

1327 Sikes (1922). *Modern Water Legislation*. Public Works Department, Nairobi. 1922.

1328 Sikes (1922). *Modern Water Legislation*. Public Works Department, Nairobi. 1922.

1329 British East Africa Protectorate (1923). *The water ordinance*, Crown Advocates Department. Kenya National Archives, Ref: AG/43/87. Nairobi, Kenya.

1330 Sikes (1922). *Modern Water Legislation*. Public Works Department, Nairobi. 1922.

The result of this lack of legislation and inadequate legislation caused waste of water resources of the colony, the construction of ill-considered projects, interference of the privileges and rights, and increasing tendency towards litigation. Disputes regarding water matters were on increase and those charged with the responsibility of guarding the water resources in the country had a very difficult task¹³³¹.

The draft water legislation was never passed into bill owing to economic slump of 1922 occasioned by the World War I and the issue was held in abeyance until 1926 when a specialist on matters of irrigation, drainage, water legislation, etc. from the Union Republic of South Africa, Mr. Lewis was invited to make an investigation and give recommendations on the same. At the time of completion of his investigations, a conference of East African Legislatures was held at Tukuyu in the same year (1926) organized to discuss and see how to harmonize water law in the region¹³³². The conference together with Mr. Lewis's report provided the required impetus for the enactment of the water legislation. One of the recommendations in Mr. Lewis's report was that an ordinance would have to be formulated to suite the unique situation of Kenya and that a selected committee be composed to oversee the process of enactment of the water legislation¹³³³.

Pursuant to Lewis's recommendation, the Water Legislation Committee was formed in 1927 with the Director of Public Works, Mr. Sikes as the Chairman. The committee took up office and by 1928 a draft bill to make provision for the employment and conservation of waters and regulate water supply, irrigation and drainage was put in the official gazette on 7th July 1928¹³³⁴.

The process of formulation of the water legislation in Kenya at that time was marred by a number of problems. Firstly the towns had not been planned; this was one of the problems encountered by Sir Ross during the preparation of the Water Ordinance of 1916¹³³⁵. Secondly, the economic slack of 1921/22 led to trimming of the work force hence a delay in the formulation and hence implementation of the water legislation¹³³⁶.

In 1930, the Secretary of the State, Lord Passfield, refused to recommend his Majesty's assent. The main reason for this outright veto from the Colonial Office

1331 Sikes (1922). *Modern Water Legislation*. Public Works Department, Nairobi. 1922.

1332 Sikes H.L (1928). *Sewerage Scheme-Kisumu Township*. Kenya National Archives, BY/29/29, Ref: San.686/17. 10th March 1928.

1333 Lewis A. D (1926). *Report on irrigation, water supplies for stock and water law*. Kenya National Archives, Ref: AG/43/86. Nairobi, Kenya.

1334 Sikes H.L (1928). *Sewerage Scheme-Kisumu Township*. Kenya National Archives, BY/29/29, Ref: San.686/17. 10th March 1928.

1335 Ross W.M (1916). Letter written to Hobly, the Provincial Commissioner, Mombasa, Kenya National Archives, PC/Coast/1/14/89. 30th September 1916.

1336 Sikes H.L (1926). *Report by Mr. A.D. Lewis on Irrigation etc.*, in Kenya Colony, December 1925, Kenya National Archives, AG/43/87, 18th June 1926.

was that under the proposed legislation, the rights of the Africans living on Native Reserve Lands were not sufficiently protected. The Secretary of State now demanded that the ordinance should be revised. All activities affecting waters in Native areas should be subject to approval of the Native Lands Trust Board, the authority in charge of protecting the rights of 'natives' as laid down in the Native Lands Trust Ordinance¹³³⁷. It should also clarify that the Native Lands Ordinance was superior to the Water Ordinance. Hence, the colonial government had walked right into a legal trap they themselves had prepared by introducing a dual legal regime.

Thus, the new water legislation that had been painstakingly developed over fifteen years therefore had to be kept in the drawer until the issue of Africans' rights to water had been resolved. The question was referred to the Kenya Lands Commission, who in 1934 established that no distinction should be made with regards to Native or Crown lands with regards to the powers and procedures of the Water Ordinance. All areas should be under the jurisdiction of the Water Board, and the Native Lands Trust Board, who legally acted as a trustee for the Africans, should be regarded as any riparian landowner¹³³⁸.

Although no amendments had been made to improve the protection of Africans' rights, obviously this new interpretation satisfied the Colonial Office. A new Secretary of State was now presiding in London, Mr Cunliffe-Lister, and in December 1934 he forwarded his Majesty's assent for the Water Ordinance of 1929¹³³⁹. On July 1st 1935, Kenya's first water legislation was finally brought into commencement¹³⁴⁰.

Before the first comprehensive water legislation was acceded to, further rigorous discussions on the Draft bill were held culminating in the enactment of the Water Ordinance of 1929.

The process of formulation of the water legislation in Kenya at that time was marred by a number of things. Firstly the towns had not been planned; this was one of the problems encountered by Sir Ross during the preparation of the Water Ordinance of 1916. Secondly, the economic slack of 1921/22 led to trimming of the work force hence a delay in the formulation and hence implementation of the water legislation. Thirdly the white settlers saw the legislation as a threat to them mainly because it was going to remove the right possess from the public and to vest

1337 Secretary of State for the Colonies to the Governor of Kenya, Dispatch dated 1930-7-8. Kenya National Archives, Ref: AG/43/79.

1338 Director of Public Works, letter to the Colonial Secretary, dated 1934-3-7. Kenya National Archives, Ref: AG/43/79.

1339 Secretary of State for the Colonies to the Governor of Kenya, Dispatch dated 1934-12-3. Kenya National Archives, Ref: AG/43/80.

1340 Colony and Protectorate of Kenya. The Official Gazette, 25 June 1935. Kenya National Archives, Ref: AG/43/79.

the powers in one person ‘The Governor’ and hence deny them the right to water which so desperately need to run their expansive farmlands¹³⁴¹..

The problem of town planning was solved by the production of town plans before any water supplies could be developed. The economic slack in 1921 was an unprecedented problem, which the colony had no power over. Meanwhile the protestation by the white settlers was handled by the invitation to all the select committee meetings of all interested white settlers to alleviate any suspicion that such legislation would in fact infringe on their right to water¹³⁴²..

The Water Act Cap 372: The Water Ordinance was revised in 1951, and the Minister for Agriculture was given the overall mandate (Table 3.66) over water development policy. It was again revised in 1972 when it was renamed Cap 372 of Laws of Kenya. These legislations structured the provision of services in urban areas similarly as the Minister in charge of water resources would appoint a “Water Undertaker” for each town. The Water Undertaker could be the local authority, the government through its Ministry responsible for water, or any other person or organisation. The Undertaker developed Regulations, to be approved by the Minister, defining the operations and tariffs etc. in the service area. The Minister would also have a monitoring role to ensure the quality of services. Furthermore, all three acts provided for an advisory body that would assist the Minister with policy and the implementation of the legislation¹³⁴³.

Interestingly, the direct influence from the minister over this advisory body increased with each revision, at the expense of influence from the technical wing of government¹³⁴⁴.

This Act held up and was sufficient for a rather long period of time, until 2002 when a new act was enacted to accommodate increasingly complex administration of the water sector. This newest Legislation is now entitled the Water Act 2002.

The Act (Cap 372) was amended in 1962 and 1972. Under the Water Act cap 372, many organisations were involved in the urban water supply and development and management. Some were concerned with policies, others with implementation,

1341 Nyanchaga E.N and Ombongi K.S (2007). History of Water Supply and Sanitation in Kenya, 1895-2002. Environmental History of Water, Chapter 21. IWA Publishing, Alliance House, 12 Caxton Street, London UK.2007.

1342 Nyanchaga E.N and Ombongi K.S (2007). History of Water Supply and Sanitation in Kenya, 1895-2002. Environmental History of Water, Chapter 21. IWA Publishing, Alliance House, 12 Caxton Street, London UK.2007.

1343 Ministry of Water Development, Kenya and Swedish International Development Authority (1992). Delineation Study the Water Sector in Kenya, July 1992.

1344 Colony and Protectorate of Kenya, Official Gazette, 31 December 1929, Water Ordinance 1929. AG/43/79; The Water Undertakers Rules, 1953. Kenya Official Gazette Supplement No. 31, 26 May 1953; Laws of Kenya. The Water Act Chapter 372. Government Printer, Nairobi. Revised Edition 1972. The water Undertaker Rules, Subsidiary to Cap 372.

operations and maintenance and others had multiple roles, which led to conflicts in the sector.

The WHO Report No 6 concentrated on holistic study of the Water Act (Cap 372) and considered by the consultants that the change of an act required time and serious thought. The following were principles recommended¹³⁴⁵:

“A comprehensive water Act should be introduced in due course, but it should not be drafted in haste; Meanwhile much can be done under the existing law to improve matter, particularly in the fields of sewerage disposal, abstraction and pollution control, so that amendments to the existing law could be limited to those necessary to meet changing circumstances; there should be a move as quickly as possible towards a single enforcement agency”.

Therefore, the main problems in the sector blamed on the institutional weaknesses from lack of clear defined framework apportioning roles and responsibilities. In particular, the role of MWRMD as a primary service provider and principal regulator undermined the performance of the sector.

Also the regulatory functions related to water resource management, (abstraction and discharge/pollution), were not kept abreast of the physical, economic and political developments hence need for amendments. And as with many other legal requirements, the water related regulations had not fully escaped abuses, “in the name of short-sighted development”, and by influential individuals”. Moreover, the punitive measures had been far too lenient to serve as an effective deterrent; for instance the returns from irrigated cultivation were usually far much higher than the applicable fines for illegal abstractions. The Draft Act proposed a substantial upgrading of the specified penalties; these should however, be revised regularly at set intervals¹³⁴⁶.

MoWD had operated for long without the powers to prosecute offenders in court. MoWD/WAB had been reluctant to take local authorities and the central government itself to task over violations. The few court cases they had dealt with concerned private farmers and industrial concerns¹³⁴⁷.

Rules and regulations recommendation: To solve the above problems the MoWD recommended that, the same rules should be applied for all water undertakers whether they are Local Authorities (LA) or larger agencies. Every LA undertaking

1345 WHO (1972b). Sectoral Study and National Programming for Community and Rural Water Supply Sewerage and Water Pollution Control. Report No 6. Water Legislation. Brazzaville.

1346 Ministry of Water Development, Kenya and Swedish International Development Authority (1992). Delineation Study the Water Sector in Kenya, July 1992.

1347 Ministry of Water Development, Kenya and Swedish International Development Authority (1992). Delineation Study the Water Sector in Kenya, July 1992.

water supply was supposed to have an appointed water undertaker under the Water Act. There was also an urgent need to establish environmental assessment and management guidelines¹³⁴⁸.

The MoWD reported that most legal problems encountered arose from low level of implementation and enforcement of the law, and not from any serious deficiency in the legal provisions. Thus, practical responsibilities for the implementation and enforcement were supposed to be entrusted to district offices of each Ministry or LA. If co-ordination among sectors was to be achieved, they were required to report to and be co-ordinated by the District Water Board (DWB). The DWB could be assigned as a body to receive the first appeals and disputes with regard to water related issues. The MoWD recommended that a senior officer (experienced water engineer or bailiff) be assigned as chief legal training officer within the MoWD and WAB, who would be in charge of training officials concerned with legal implementation issues¹³⁴⁹.

The Water Act 2002: The water policy noted that the Water Act, Cap 372, needed to be revised. This Act held up until 2002 when a new act known as Water Act 2002¹³⁵⁰ was enacted to accommodate increasingly complex administration of the water sector. The Water Act 2002 was enacted with new institutions (Table 3.66) specified in the new decentralized setting. The legal language used in the act generally refers to policy-making, monitoring and coordination as the responsibilities of the Minister. Indeed within the Act, the Minister's statutory and discretionary powers are mentioned frequently touching on all areas of water resources management and water services. However, the decentralisation leading to accountability and efficiency that is the cornerstone of the Act calls for a clear separation of functions within the sector¹³⁵¹. This is the Acts the in existence when this book was written.

1348 Ministry of Water Development, Kenya and Swedish International Development Authority (1992). Delineation Study the Water Sector in Kenya, July 1992.

1349 Ministry of Water Development, Kenya and Swedish International Development Authority (1992). Delineation Study the Water Sector in Kenya, July 1992.

1350 Republic of Kenya (2002). The Water Act 2002. Kenya Gazette Supplement No. 107 (Acts No. 9). Government Printers, Nairobi. 24th October, 2002.

1351 Republic of Kenya (2002). The Water Act 2002. Kenya Gazette Supplement No. 107 (Acts No. 9). Government Printers, Nairobi. 24th October, 2002.

Table 3.66: Mandate of Institutions under Water Act 2002, Kenya¹³⁵²

Institution	Mandate	Institutional Documents
Ministry of Water and Irrigation	Policy formulation, sector coordination, monitoring, financing and supervision	
Water Resources Management Authority (WRMA)	Water resources management regulation	NWRMS IWRM and WE Plan for Kenya
Catchment Area Advisory Committees (CAACs)	Provide water resources management advisory functions at water catchment level	Catchment Management Strategy
Water Resources Users Associations (WRUAs)	Co-operative management of water resources and conflict resolution at sub-catchment level	Sub Catchment Management Plan
Water Services Regulatory Board (WASREB)	Regulation of water and sewerage services	NWSS and PPIP Implementation Plans for NWSS and PPIP
Water Services Boards (WSBs)	Water and Sewerage services planning and provision at regional level	
Water Services Providers (WSPs)	Direct provision of water and sewerage services as agents of the WSBs	
Water Services Trust Fund (WSTF)	Support financing of water services for underserved rural areas	
Water Appeal Board (WAB)	Handles disputes in the water sector	
National Water Conservation and Pipeline Corporation (NWPC)	Bulk water supply, dam construction, flood control, land drainage, ground water development and MWI reserve WSP	

Overall, the Act provides a sound basis for implementing water sector reforms, although there are some areas where it will need to be augmented if the policy reforms are to be effective.

The Water Act 2002 section 53 defines the powers and function of water services boards. A water services board shall, as a licensee, be responsible for the efficient economical provision of water services authorised by the licence.

The Water Act section 51-55 creates Water Services Board and Water Service Providers. Water Services Board may arrange for the exercise and performance of all or any of its powers and functions under the license by one or more agents, to be known as water service providers. Section 55, subsection (3) of the Act demands that the agreement shall specify the powers and functions under the license, which shall be exercised and performed by the water service provider during the currency

¹³⁵² Ministry of Water and Irrigation and Water and Sanitation Program - Africa (2008) "Water Sector Reforms: Five Years On" in R. Gakubia, et al., Eds., *Kisima* (5). Nairobi, Republic of Kenya.

of the agreement. Subsection (5) states that the water services board may enter into agreements with more than one water service provider in respect of its area of supply. No person shall, (section 56 (1) on provision of water), within the limits of supply of a licensee:

- Provide water services to more than twenty households; or
- Supply more than twenty five thousand litres of water a day for domestic purposes; or
- More than one hundred thousand litres of water a day for any purpose, except under authority of the license.

The Water Act 2002 Section 83 creates Water Services Trust Fund. The object of the Fund is to assist in financing the provision of water services to areas of Kenya which are without adequate water services. There shall be paid into the Fund:

- Such moneys as may be appropriated by Parliament for the purposes of the Fund;
- Such moneys as may be received by the Fund from the donation grants, and bequests from whatever source; and
- Such other moneys as may be under any Act, be payable to the Fund.

The government of Kenya in (Economic Recovery Strategy for Wealth Creation and Employment Creation - 2003) elicits the previous initiatives in water management initiatives and reiterates government's commitment to improved water and sanitation services. The government recognises that the current institutional arrangements are inappropriate and a bottleneck to achieving the set poverty reduction objectives. The government proposes to undertake comprehensive institutional reforms that will facilitate pro-poverty water and sanitation services programmes. Among the key reforms are to:

- Establish a Water Services Regulatory Board to be responsible for over-seeing water services provision and licensing.
- Establish Water Services Boards to be responsible for water and sanitation services provision and asset development.
- Transfer government water and sanitation services schemes to Services Boards, communities and other lower level actors.
- Implement Private Sector Participation in financing and management of water and sanitation services.

- Develop models for distribution of water and sanitation to the poor in both rural and urban areas.
- Establish Water Services Trust to facilitate financing of water development in rural and low income areas of the country.

There is a pressing need to re-evaluate the permit allocation and issuance procedures in handling the challenges eminent in the system. There is a need to ensure that the latest version of issued water permit data is maintained to enable accurate control of issued water permits by reflecting the current water use. It is imperative that the existing water allocation guidelines of WRMA are revised considering future water demands and usable amount of water resources. Taking into account the actual situation of water permit issuance and control in WRMA regional offices, an increase of water right officers for smooth execution of the works should be considered¹³⁵³.

The National Water Policy of 1999 and the Water Act of 2002 laid the groundwork for water sector reforms witnessed over the last decade. The reforms set on international standards, focused on significantly contributing towards accelerating the social and economic development of the Country. Visible improvements that were noted some of include:

- All institutions envisaged by Water Act 2002 had been established and were functioning, thereby fulfilling separation of mandates.
- The sector had attracted more resources which confirmed commitment and confidence by government and development partners respectively to the reform.
- Socially responsible commercialisation of water services had been successful in urban areas.
- The sector was increasingly responding to regulation, to human right to water and sanitation, stakeholder participation and gender parity.
- Water resources management was increasingly receiving the desired attention.
- There was a strong pro poor orientation.

Key objectives of the reforms had further been given a boost by the adoption of the new Constitution of Kenya (CoK) 2010. The Bill of Rights in the constitution enshrines the right to adequate clean and safe water, as well as reasonable standards of sanitation (Article 43) to every person. It also enshrines a right to be free from hunger and to have adequate food of acceptable quality, which has implications on water for production.

¹³⁵³ Nippon Koei co Ltd. The Development of National Master Plan 2030.

As the reforms went on, the sector was aligning itself to the new constitution and subscribing to a more comprehensive approach by enlarging efforts of the ongoing reforms on conservation, replenishment and development of water resources, to include water storage and water for production as articulated in Article 42.

3.9 Governance of the Water Sector

The existing domestic economies consisting of nomadic and sedentary pastoral complemented each other by 1880¹³⁵⁴. There was a universal right to water but with certain water rights allocated to groups or individuals for specific uses through a social negotiation process¹³⁵⁵.

When the British Government bought Kenya and declared it the British East Africa Protectorate (BEAP) in 1895, the construction of the Uganda Railway began in Mombasa in 1896, reached Nairobi in 1899 and later Port Victoria present day Kisumu City, in 1901¹³⁵⁶. The Uganda Railways started the development of water supplies in Kenya; Nairobi, Mombasa, Nakuru, Naivasha, Kisumu and other towns¹³⁵⁷. The Hydraulic Branch (HB) of the Public Works Department (PWD) under the Director of Public Works (DPW) undertook management of water by 1901. In 1902, 1903, and 1910 the HB opened offices in Nairobi, Kisumu and both Naivasha, Eldoret and Nyeri respectively¹³⁵⁸. As the British took over the resources of the protectorate the grip by the African institutions systematically relaxed and the customary role they played was significantly reduced¹³⁵⁹.

The first attempt by the private sector to take part in water ownership was made in 1898 through effort to license a private water provider. By 1914, the large-scale European farmers played a key role in development of private water services mostly in their farms. In September 1914, the Government went into agreement

1354 Jacobs, A. H (1963). *The Pastoral Maasai of Kenya: A Report of Anthropological Field Research*. Department of Anthropology, University of Illinois, Illinois.

1355 Meinzen-D R and Nkonya L (2005), 'Understanding legal pluralism in water rights: lessons from Africa and Asia', paper presented at International workshop on 'African Water Laws: Plural Legislative Frameworks for Rural Water Management in Africa', 26-28 January 2005, Johannesburg, South Africa. Internet source checked 2006-11-01 <http://www.nri.org/waterlaw/AWLworKESop/MEINZEN-DICK-R.pdf>.

1356 Marsh Z.A. and Kingsnorth G.W (1965). *An Introduction to the History of East Africa*. Cambridge University Press, 3rd Edition. British Institutes of History and Archaeology in East Africa.

1357 Colony and Protectorate of Kenya (1913-1923). *Muthaiga Water Supply*. Kenya National Archives, Ref: AG/43/103, Nairobi, Kenya.

1358 Nyanchaga E.N and Ombongi K.S (2007). *History of Water Supply and Sanitation in Kenya, 1895-2002*. Environmental History of Water, Chapter 21. IWA Publishing, Alliance House, 12 Caxton Street, London UK.2007.

1359 Lotte H (2006). *Moving the Maasai, A Colonial Misadventure*. Palgrave Macmillan, in Association with St Anthony's College, Oxford.

with Captain James Archibald Morrison of the Upper Nairobi Township and Estate Company Limited for the supply of water to the up-market areas of Nairobi such as Muthaiga. The company operated until around 1923 when Muthaiga water supply was taken over by the Nairobi Municipal Corporation¹³⁶⁰.

The state took over urban water supplies from railways in late 1920¹³⁶¹ and the Public Works Department developed new township water supplies. The railways abandoned some water supplies and connected to the new supplies¹³⁶².

In order to have an organized development in the water scarce areas of the Northern Frontier Districts, Dixey scheme was put forward in 1943¹³⁶³. However, after a pilot project, the Water Resources Authority recommended that water development in the Northern Province should be restricted to the exploitation of surface catchments and construction of pans, dams and tanks¹³⁶⁴.

In 1946, the colonial government launched an ambitious investment programme under the Development and Reconstruction Authority (DARA), which sparked off a rapid development of urban water supplies¹³⁶⁵ and African Land Development Board (ALDEV in arid and semi-arid lands (ASAL) production¹³⁶⁶. In 1954, hard formal water development plan known as “the Swynnerton Plan” was introduced under the Ministry of Agriculture meant to facilitate African agriculture¹³⁶⁷.

In order to guide the East African countries the East Africa Royal Commission was established between 1953 and 1955. Creation of a single department in each territory to administer all aspects of water supplies, apart from urban supplies was agreed¹³⁶⁸.

Hebert Manzoni in 1956 enquired into reorganisation of PWD and recommended the transfer of the HB to the Department of Agriculture, all supplies in large towns be taken over by the Local Authorities and the Ministry of Agriculture

1360 Colony and Protectorate of Kenya (1913-1923). Muthaiga Water Supply. Kenya National Archives, Ref: AG/43/103, Nairobi, Kenya.

1361 Colony and Protectorate of Kenya (1930). Report for 1929 His Majesty's Stationery Office, London Ref: AG/43/79, Nairobi, Kenya.

1362 Nyanchaga E.N and Ombongi K.S. (2007). History of Water Supply and Sanitation in Kenya, 1895-2002. Environmental History of Water, Chapter 21. IWA Publishing, Alliance House, 12 Caxton Street, London UK.2007.

1363 Dixey, F (1950) Hydrological report on the Northern Frontier District, Samburu and Turkana and Report on the Hydrology of the Uaso.

1364 Provincial Commissioner (1951). Northern Frontier Province, Annual Report of 1951. Kenya National Archives. PC/NFD/1/1/10, 1951.

1365 Colonial Office (1950). Annual Report on the Colony and Protectorate of Kenya for the year 1948. His Majesty's Stationery Office, London.

1366 Provincial Commissioner (1946). Annual Report Northern Frontier District, 1946. Kenya National Archives. PC/NFD/1/1/8, 1946.

1367 Swynnerton J R M (1957). Kenya's Agricultural Planning, African Affairs, Volume 56, Number 224, July 1957.

1368 Royal East Africa Commission (1955). Kenya National Archives, AH/6/2. 1953-1955.

(MoA) should operate supplies in smaller towns¹³⁶⁹. This model outlived the colonial government by 25 years. In the early 1960s, three sections were involved in water supplies provision, The Ministry of Works (MoW), Water Development Department and the Local Authorities causing duplication of duties hence inefficiency. Manzoni's recommendations were implemented in 1964. The Water Development Department was formed under the Ministry of Agriculture, Animal Husbandry and Natural Resources to deal with both rural and small towns¹³⁷⁰.

Prior to 1964, water development was managed by the hydraulic branch of the ministry of Works in urban areas, and the African Land Development Organisation in rural areas. These organisations were amalgamated with the Ministry of Natural Resources in 1964 into the Water Development Department. The Department was transferred under the ministry of Agriculture in January 1968. Later that year it became Water Development Division, and in 1972, it became a department again¹³⁷¹.

In 1972, the Water Development Division was elevated to a Department and the Director of Water Development became directly responsible for the provincial organisations. The Water Department was given the overall responsibility for water development in the country¹³⁷². The Ministry of Local Government (MoLG) was in charge of water supplies in major municipalities¹³⁷³.

In 1974, the department was upgraded to the Ministry of Water Development (MoWD). MoWD was restructured into the Ministry of Land Reclamation, regional and Water Development (MOLRRW) in 1992. In 1997, water affairs were transferred to the Ministry of water Resources, and in 1999 the Water Department was given the 1964 status of a Department in the ministry of Environment and natural resources.

On June 24 1988, through Legal Notice No. 270, the President ordered that the National Water Conservation and Pipeline Corporation (NWCPC) be established, under the State Corporations Act. NWCPC supposed to operate those water supplies placed under its care on commercial basis¹³⁷⁴. The main objectives were to commer-

1369 Cabinet Office (1957). Council of Ministers. Kenya national Archives, ACW/32/30. 26th March 1957.

1370 Tempelhoff J.W.N (2005). African Water Histories, Vaal Triangle Faculty North-West University Vanderbijlpark, 2005.

1371 Hukka J.J. and Katko P.S. (2002). Water Privatisation Revisited-Panacea or Pancake: *Public-Private Partnership in Water and Sewerage Services in Kenya-Dr. Nyangeri E.N.* Tampere University of Technology, Finland.

1372 WHO (1972). Sectorial Study and National Programming for Community and Rural Water Supply Sewerage and Water Pollution Control. Report No 2. Recommendations on National Programme for Community Water Supply Development. Brazzaville.

1373 WHO (1973). Sectorial Study and National Programming for Community and Rural Water Supply Sewerage and Water Pollution Control. Report No 10. Recommendations on Administration and Organization structure for water supply development. Brazzaville.

1374 Nyangeri E N (2003). 'Scope for public-private partnerships in WSS services in Kenya, in J Hukka and T Katko, (Eds), Water Privatisation Revisited. Panacea or Pancake? IRC International Water

cialise water sector operations by determining the charges for water supplied by the Corporation and establishing water tariff structure for any particular consumer¹³⁷⁵.

Yet irrespective of the ministry or department under which the portfolio of water affairs was placed, the most important player in the water sector remained the Department of Water Development. The functions of Water Department included policymaking, regulatory affairs, water resource development and management, and provision of water supply and sewerage services as a water undertaker¹³⁷⁶.

The responsibilities and powers of the local authorities i.e. Municipal, town and county councils in providing services to the local population varied. Yet, some of them including water supply and sewerage were discretionary rather than mandatory. Local authorities were held responsible for sewerage and sanitation as a matter of course in accordance with the Local Government Act (Cap 265)¹³⁷⁷.

In Kenya, privatisation first became a major policy tool in the 1980s with the IMF-World Bank imposition of Structural Adjustment Programs (SAPS) which forced the governments to free markets and pull out of loss making state enterprises¹³⁷⁸. To carry out the commercialisation of the services, the Ministry of Local Government with the support of the Germany Agency for Technical Corporation (GTZ) established the Urban Water and Sanitation Management (UWASAM) project aimed at assisting local authority in self-sustainability for their water and sanitation services through commercialisation and privatisation¹³⁷⁹.

Governance of water in the slums, Kibera: Populations in urban slums continued to rise due to the relatively affordable shelter provision. Most slums were neither planned nor formal and therefore lack basic service delivery. Despite the fact that the majority of inhabitants in these slums were low-wage earners, they were forced to pay more for basic needs such as water at a higher price than their neighbours in

and Sanitation Centre, Delft pp 66-74.

1375 Nyanchaga E.N and Ombongi K.S. (2007). History of Water Supply and Sanitation in Kenya, 1895-2002. Environmental History of Water, Chapter 21. IWA Publishing, Alliance House, 12 Caxton Street, London UK.2007.

1376 Hukka J.J and Katko P.S. (2002). Water Privatisation Revisited-Panacea or Pancake: *Public-Private Partnership in Water and Sewerage Services in Kenya*-Dr. Nyangeri E.N. Tampere University of Technology, Finland.

1377 Hukka J.J and Katko P.S. (2002). Water Privatisation Revisited-Panacea or Pancake: *Public-Private Partnership in Water and Sewerage Services in Kenya*-Dr. Nyangeri E.N. Tampere University of Technology, Finland.

1378 Anyang, Neon (Ed) et al, (2000). The context of Privatization in Kenya, Academy Science Publishers, 2000, Nairobi.

1379 Urban Water and Sanitation Management Project (2001). Plan for the Second Half of Phase V. Summary of the Proceedings and Outcomes of the Workshop. 13th -14th November 2001. Nairobi, Kenya.

wealthy neighbourhoods. Figure 3.60 show a section of Kibera slums in outskirts of Nairobi City¹³⁸⁰.

The water sold in Kibera was pumped from dams constructed in the previously 'high rainfall' areas of Sasumua, Ruiru and Thika in the environs of Nairobi. By 2004, Nairobi (and Kibera in essence) was experiencing a drastic reduction of volumes of water supplied which led to acute run-offs with resultant siltation problems in dams and intakes. Kibera relied on hawked water drawn from piped water, boreholes and the polluted Nairobi River to meet its water needs. Drinking water was pumped through plastic pipes alongside sewage trenches. Despite many attempts to address Kibera and other slums water supply the challenge comes up due to the fact that the settlements were informal and in fact illegal. As a consequence, Nairobi City Council was not obligated to provide it with water and a sewerage system.



Figure 3.60: A section of Kibera slums in the year 2008

Over the decades and especially during the United Nations International Drinking Water and Sanitation Decade, (1981-1990), many water projects were set up and deployed in areas like Kibera, governments, donor agencies, Non-Governmental Organisations (NGOs) and Community-Based Organisations (CBOs) have with little success initiated water projects. Poor management structures and diminishing resources made it difficult for governments to maintain and sustain these projects, leading to the collapse of many of the water projects. As a result, there was a marked

¹³⁸⁰ Birongo J. M. and Le N. Q (2005). An Analysis of Water Governance in Kibera Kenya: International Master of Science in Environmental Policy and Global challenges. First year project. Roskilde University Centre.

decline in water and sanitation coverage, access, and considerable loss of investments and user benefits¹³⁸¹.

By the year 2005, Kibera water supply existed in a unique public private partnership between Nairobi Water Company and Maji Bora Kibera a type of private enterprise representing hundreds of small scale water vendors in Kibera and serving approximately 500,000 inhabitants. These two had an acrimonious relationship, which worsened the situation of water supply, time before they entered into a partnership in 2004. The situation was further complicated by the presence of the private water vendors. The vendors plied their trade in Kibera without any government regulation or recognition. They obtained water from illegally Nairobi City council water and sewerage department, currently Water Company, connections¹³⁸².

3.10 Access to Water and Sanitation Services

By 1972 nearly 20% of total Kenyan population was served by a modern water service, more than double the percentage typical of developing countries. It was estimated that by 1980, this percentage would be 30% and the population served increase from 2.27 million in 1972 to 4.96 million. Table 3.67 shows the estimated population served by protected water supplies by 1972 according to WHO Sectorial study Report, No. 2, 1972.

Table 3.67: Access to water and sanitation

Province	Urban		Rural				Total
	Major centre	Urban centre	Rural centre	High potential	Medium potential	Low potential	
Central	600,000	105,400	41,000	193,500	18,000	8,000	965,900
Nyanza	-	45,700	7,500	15,000	87,500	25,000	180,000
Eastern	-	19,000	24,000	38,500	19,500	112,000	213,000
North Eastern	-	-	10,000	-	-	21,000	31,000
Rift Valley	-	122,400	32,000	137,000	46,500	43,500	381,400
Coast	286,000	-	30,000	27,500	28,000	36,000	407,500
Western	-	12,500	2,000	73,500	2,500	-	90,500
Total	886,000	305,000	146,500	485,000	202,000	245,500	2,270,000

1381 Birongo J. M. and Le N. Q. (2005). An Analysis of Water Governance in Kibera Kenya: International Master of Science in Environmental Policy and Global challenges. First year project. Roskilde University Centre.

1382 Birongo J. M. and Le N. Q. (2005). An Analysis of Water Governance in Kibera Kenya: International Master of Science in Environmental Policy and Global challenges. First year project. Roskilde University Centre.

All forms of water development were accorded high priority by the Government. Table 3.68 shows the level and trend of Central Government and Other Public Authority development expenditure on water supplies and related services over a five-year period¹³⁸³.

Table 3.68: Government expenditure on water supplies

Water Supplies	Government expenditure (£)				
	1967/68	1968/69	1969/70	1970/71	1971/72
Municipal water	982	491	360	1,644	2,284
Small towns	162	211	81	134	208
Rural water	58	139	253	408	654
Settlement	97	214	89	53	114
Health and self-help	47	70	46	56	59
Range water	6	7	11	6	392
Planning	91	80	162	206	140
Total	1,443	1,212	1,002	2,507	3,851

NB: From Table 3.68, it can be concluded that the greatest proportional increase was accorded to rural water development, and the 1970-71 estimate was nearly 5% of total public sector capital expenditure.

¹³⁸³ Agrarian Development Studies (1977). Impact and Economics of Community Water Supply. A Study of Rural Water Investment in Kenya Report No 6. Carruthers.I.D

CHAPTER FOUR

4.0 DRIVERS OF WATER SUPPLY SERVICES

Alongside the natural forces affecting water resources are new human activities that have become the primary ‘drivers’ of the pressures affecting our planet’s water systems. These pressures are most often related to human activities and economic growth. Our requirements for water to meet our fundamental needs and our collective pursuit of higher living standards, coupled with the need for water to sustain our planet’s fragile ecosystems, make water unique among natural resources. Drivers should not be considered in isolation of related socioeconomic and political factors or of other drivers.

Many natural links also influence how drivers affect changes, directly and indirectly. Water properties are governed by biological, chemical and physical laws that define the quantity and quality of water resources, regardless of human influences, and that are linked in various ways. Superimposed on these natural processes are human activities that intensify these processes and disrupt the natural balance of water systems.

Economic growth, a principal driver of water use, is affected by a wide range of policy decisions, from international trade to education and public health, while the potential rate of economic growth can be affected by demographic variables such as population distribution (local workforce availability) and social characteristics (workforce capacity and the role of women) and by the availability of new technologies. Water availability is also directly subject to the impacts of climate change, which also can exert additional pressures on the other drivers.

The result of these combined and interacting forces is a continuously increasing demand for finite water resources for which there are no substitutes. When water resources of acceptable quality can no longer be provided in sustainable quantities, the outcome can be overexploitation of aquatic ecosystems. The ultimate losers are the exploited aquatic ecosystems and the organisms (including humans) dependent on them for survival and well-being.

Demographic, economic and social drivers: Human activities and processes of all types: demographic, economic and social – can exert pressures on water resources and need to be managed. These pressures are in turn affected by a range of factors such as technological innovation, institutional and financial conditions and climate change¹.

Demographic drivers: Population dynamics (growth, gender and age distribution, migration) create pressures on freshwater resources through increased water demands and pollution. Changes in the natural landscape associated with population dynamics (migration, urbanization) can create additional pressures on local water resources and the need for more water-related services².

Economic drivers: Growth and changes in the global economy are having far-reaching impacts on water resources and their use. Growing international trade in goods and services can aggravate water stress income countries while relieving it in others through flows of ‘virtual water’ (water embedded in products and used in their production, particularly in the form of imported agricultural commodities).

Social drivers: Social drivers are mainly about individual rather than collective actions and about the way people think and act on a day-to-day basis. Social drivers influence human perceptions and attitudes about the environment, including water resources, in turn influencing the people. Alongside the natural forces affecting water resources are new human activities that have become the primary drivers’ of the pressures affecting our planet’s water system son water through water demands and uses. Changes in lifestyles represent one of the principal drivers of change. They reflect human needs, desires and attitudes which are influenced by such social drivers as culture and education and by economic drivers and technological innovation; the

1 The 3rd United Nations World Water Development Report: Water in a changing World (WWDR-3).

2 The 3rd United Nations World Water Development Report: Water in a changing World (WWDR-3).

rapid global rise in living standards combined with population growth presents the major threat to the sustainability of water resources and the environment³.

Technological innovation: Technological innovation is driven largely by both human wants and needs. It can create both positive and negative pressures, sometimes simultaneously, resulting in increased or decreased water demand, supply and quality⁴.

One of the most unpredictable drivers, technological innovation can create rapid, dramatic and unexpected changes, both in pressures and solutions. Impediments to the dissemination of technology must be overcome for developing countries to benefit from innovations developed in richer countries.

Policies, laws and finance: Efforts to implement water management effectively and efficiently and to properly inform the decision-making process are facilitated by the adoption of water resources management laws, policies and strategies that reflect links between water and the social and economic sectors. Good examples can be found in many countries⁵.

But even if all the necessary policies and laws are in place, development of water resources will not take place without adequate funding of infrastructure and the institutional and human capacity of the sector.

Policies and laws: Effective policies and legal frameworks are necessary to develop, carry out and enforce the rules and regulations that govern water use and protect their source. Water policy operates within a context of local, national, regional and global policy and legal frameworks that must all support sound water management goals⁶.

Legitimate, transparent and participatory processes can effectively mobilize input for designing and implementing water resources policy and create a strong deterrent to corruption. Corruption remains a poorly addressed governance issue in the water domain. It can lead to uncontrolled pollution of water sources, over pumping and depletion of groundwater, lack of planning, degradation of ecosystems, weakened flood protection, urban expansion leading to heightened water tensions, and other harmful effects.

Finance: Although water is often described as a 'gift of nature', harnessing and managing it for the wide variety of human and ecological needs entails financial costs. While there may appear to be many financing options for water resources

3 The 3rd United Nations World Water Development Report: Water in a changing World (WWDR-3).

4 The 3rd United Nations World Water Development Report: Water in a changing World (WWDR-3).

5 The 3rd United Nations World Water Development Report: Water in a changing World (WWDR-3).

6 The 3rd United Nations World Water Development Report: Water in a changing World (WWDR-3).

development, governments still have only three basic means of financing them: tariffs, taxes and transfers through external aid and philanthropy⁷.

Policy-makers need to make political decisions on socially and environmentally acceptable trade-offs among different objectives and on who bears the costs of such compromise.

Commitments have been made by the donor community to increase assistance to the broad water sector, but this has led mainly to an increase in allocations for water supply and sanitation in dollar terms (although its share of total official development assistance has stagnated at 4%), and the percentage of total aid allocated to the water sector remains below 6% and has been declining.

Climate change and possible futures: The external drivers of change, strongly connected, create complex challenges and opportunities for water managers and decision-makers in government, the private sector and civil society. Climate change and variability, while seldom the main stressors on sustainable development, can impede or even reverse development gains⁸.

Climate change: There is evidence that the global climate is changing and that some of the change is human-induced. The main impacts of climate change on humans and the environment occur through water. Climate change is a fundamental driver of changes in water resources and an additional stressor through its effects on external drivers⁹.

Policies and practices for mitigating climate change or adapting to it can have impact on water resources, and the way we manage water can affect the climate.

Public policy, so far dominated by mitigation, could benefit from a better balance between mitigation and adaptation. Carbonic a measure of the anthropogenic causes of climate change – water is a measure of its impacts. The international community also has to balance investing for tomorrow's likely problems of greater climate variability and global warming against investing for today's problems of climate variability to prevent losses from droughts and floods. While both are vital, focusing on today's problems can also create greater resilience for dealing with the problems of tomorrow.

The development of water supplies in Kenya over a century has been by design, coincidence and accident. The factors compelling development of water supplies ranged from disease and sanitation, economic development, globalisation, popula-

7 The 3rd United Nations World Water Development Report: Water in a changing World (WWDR-3).

8 The 3rd United Nations World Water Development Report: Water in a changing World (WWDR-3).

9 The 3rd United Nations World Water Development Report: Water in a changing World (WWDR-3).

tion growth, urbanisation, growth in technology among other factors. These driving forces can be classified into three general categories. First, the well-known drivers which have affected water management practices and processes in many ways such as population increase and urbanisation. Secondly, the category involves forces that affect water use as well as waste water generation such as economic growth, technological development and energy generation. While the relevance of these factors has sometimes been implicitly recognized in water management, they have seldom been explicitly considered for policy and planning purposes. Those drivers that are completely ignored by mainstream water professionals such as globalisation, immigration etc. comprises the third category¹⁰.

4.1 Socio-Economic Development

Without water there can be no life and no development. Although water is necessary for sustainable development, by itself it is not sufficient to achieve development. This means that it is one factor in the process of socio-economic development. Broadly water fulfils an economic, social, cultural, political and ecological role in improving people's quality of life. But millions of people do not even have access to clean drinking water and sanitation, never mind using water for development. An ever-increasing population, rapid urbanization and industrialization, the unsustainable type of development path followed and widespread poverties and growing inequalities, will only make this situation worse in the future. Proposals on how to address these challenges and ensure access to water for all, has to do with viewing water as an economic commodity or enforcing it as a human right of all. But underlying all these challenges and views, are the realities of water being a source of power and wealth¹¹.

With water being distributed unevenly over the face of the earth, human settlement had historically evolved close to water resources like rivers and lakes. The added benefit was that such water resources could also be used for transport. Such surface water resources, together with rainfall, made household food production possible. Since water was seen as a free "gift" that could be used freely, people started to store water in, for example dams to make more irrigation possible. In drier areas they dug holes to find ground water and extracted this for use. But water also played

10 Biswasa A.K., Tortajada C., Izquierdo R (2009). *Water Resources Development and Management: Water Management in 2020 and Beyond*-Spring-Verlag Berlin Heidelberg, 2009.

11 Rooyen, C. *Water as a Factor in Socio-Economic Development: Future Trends*. Department of Anthropology and Development Studies, RAU, South Africa. <http://www.unl.org/unldoc/EOLSS/E2-25-03-03-TXT.aspx>.

a key role in making the Industrial Revolution possible. Over time an ever-growing human population and the spread of industrialisation lead to increased demands for water – these two issues are still relevant as future challenges facing water and development¹².

An indication of the role of water in economic development is that many of the poorest countries in the world are also experiencing water shortages and scarcity. But although water is needed for economic development, water by itself is not sufficient to ensure development. Water is just one of many factors necessary in the process of development. Thus, water must then be seen in a broader context and managed integrated¹³.

The general uses of water are mainly for human consumption and sanitation, food production, industrialisation, energy, transportation and environmental conservation. Although crucial, water consumption and sanitation only make up ten per cent of the global water use. Other household or domestic uses of water are for cooking food, bathing and hygiene, and use in the construction of shelter. Water is also needed for the production of foods like livestock and fisheries. Irrigation is the largest use of water. It represents about 70 per cent of global water use. Many therefore refer to the abuse of water by irrigated agriculture. Such intensive irrigation is needed in modern farming processes, mainly practiced by the rich farmers of the world. Although irrigated water can be reused, much of it is contaminated with nutrients and chemicals from pesticides and herbicides. This contributes to the building up of salt concentrations that can make the soil infertile¹⁴.

Without water there can be no health. There are many diseases closely related to the quantity and quality of water, like diarrhea, cholera and dysentery. Every year about five million people, mostly children, die from such water-borne diseases, and about half of the population of the developing countries suffers from water-borne diseases¹⁵.

But the role of water is beyond simply providing water for healthy living. Except for these general, and mostly economic, uses of water, water has important social, cultural and spiritual roles in the life of communities. If people are healthy,

12 Rooyen, C. Water as a Factor in Socio-Economic Development: Future Trends. Department of Anthropology and Development Studies, RAU, South Africa. <http://www.unl.org/unldoc/EOLSS/E2-25-03-03-TXT.aspx>.

13 Rooyen, C. Water as a Factor in Socio-Economic Development: Future Trends. Department of Anthropology and Development Studies, RAU, South Africa. <http://www.unl.org/unldoc/EOLSS/E2-25-03-03-TXT.aspx>.

14 Rooyen, C. Water as a Factor in Socio-Economic Development: Future Trends. Department of Anthropology and Development Studies, RAU, South Africa. <http://www.unl.org/unldoc/EOLSS/E2-25-03-03-TXT.aspx>.

15 Rooyen, C. Water as a Factor in Socio-Economic Development: Future Trends. Department of Anthropology and Development Studies, RAU, South Africa. <http://www.unl.org/unldoc/EOLSS/E2-25-03-03-TXT.aspx>.

they can be more productive and do better at school. Access to water improves livelihood security, socio-economic status, gender empowerment, environmental conditions and community management. Socio-economic status is improved because of increased self-esteem and increased household income levels from, for example food production. Increased school attendance can be achieved through timesaving because of easier access to water.

The gender division of labor around water is that women must fetch water, on which they spend much of their time. In Africa and Asia women have to walk on average six kilometres to collect water. Women are also responsible for food production, which requires water. But in spite of this, they do not have much decision-making power in the household and the community, also around water. This is because water use is related to power relations. Water supply that takes into account the experiences, needs and interests of women, will go a long way in gender empowerment. A reduction in stress levels, better family and community relations and increased ability to observe religious rites and customs are also benefits of access to water. It is unfortunately these cultural and spiritual roles of water in development that is under recognized. Since time immemorial water has also fulfilled a function as one of the key social regulators. In any communities, life is organized around water. This multi-facetedness of water must be acknowledged¹⁶.

Key aspects to these roles of water in development are the access and affordability of water, which relates closely to the quantity and quality of water. Also, the different levels of development between different countries and different areas within countries mean that the demand for and role of water will be different.

Lack of access to clean water and sanitation are mostly experienced in Africa and Asia, which are also the two poorest regions in the world, while in rich countries the issues are around water quality due to water pollution. In poor countries existing water infrastructure do not reach everyone; many water leakage occur in the system; and water and sewerage treatment are inadequate. Such lack of water services includes sufficient quantity and quality of water, and reliability of water services. And despite many efforts to the contrary, the total population in Africa without access to water has increased by 15 million in the 1990s¹⁷.

16 Rooyen, C. Water as a Factor in Socio-Economic Development: Future Trends. Department of Anthropology and Development Studies, RAU, South Africa. <http://www.unl.org/unldoc/EOLSS/E2-25-03-03-TXT.aspx>.

17 Rooyen, C. Water as a factor in socio-economic Development: Future Trends. Department of Anthropology and Development Studies, RAU, South Africa. <http://www.unl.org/unldoc/EOLSS/E2-25-03-03-TXT.aspx>.

An ecological factor that influences water availability is the hydrological cycle of evaporation, condensation and precipitation leading to water taking on variable forms (solid, gas or fluid).

Global warming, droughts, desertification, deforestation and soil erosion are other ecological factors that make water shortages worse. Related to the ecological dimension is water scarcity that also has a temporal or cyclical dimension, leading to water uncertainty in many areas. The human factor in water scarcity include the effects of sedimentation, siltation and water pollution by chemicals and other waste on the quality of water available¹⁸.

Water can be re-used and can be used more effectively, which mean more water availability than simply the total quantity of current water sources. Local water harvesting systems that collect, store and use rainwater runoff are attempts at using water effectively. This can also be improved by making people in rich, developed countries aware of the waste when using water fit for human consumption, for flushing, watering garden or washing cars. This touches on the political factors influencing water scarcity¹⁹.

The political factors influencing water scarcity have mainly to do with power relations on different levels that lead to the overconsumption of water by some, while others lack water. Water is a source of power and wealth; control over it is many times used as bargaining tools, leading to increased inequalities between gender, class, race, etc.²⁰

A series of international events have taken place since the 1970s to try to do something about the real as well as socially-constructed scarcity of water and its impact on development. These include²¹:

In March 1977 the United Nations Water Conference in Argentina produced the Mar del Plata Action Plan which led to the proclamation by the UN General Assembly of 1981-1990 as the International Drinking Water Supply and Sanitation Decade. The goal of this decade was full access to safe water and sanitation for all by 1990.

18 Rooyen, C. Water as a factor in socio-economic Development: Future Trends. Department of Anthropology and Development Studies, RAU, South Africa. <http://www.unl.org/unldoc/EOLSS/E2-25-03-03-TXT.aspx>.

19 Rooyen, C. Water as a factor in socio-economic Development: Future Trends. Department of Anthropology and Development Studies, RAU, South Africa. <http://www.unl.org/unldoc/EOLSS/E2-25-03-03-TXT.aspx>.

20 Rooyen, C. Water as a factor in socio-economic Development: Future Trends. Department of Anthropology and Development Studies, RAU, South Africa. <http://www.unl.org/unldoc/EOLSS/E2-25-03-03-TXT.aspx>.

21 Rooyen, C. Water as a factor in socio-economic Development: Future Trends. Department of Anthropology and Development Studies, RAU, South Africa. <http://www.unl.org/unldoc/EOLSS/E2-25-03-03-TXT.aspx>.

The Global Consultation on Safe Water and Sanitation for the 1990s was held in New Delhi in 1990. The New Delhi Statement reaffirmed the goal of the International Decade of water and sanitation for all but now by 2000. To achieve this it foresaw the role of government changing from a provider to becoming a facilitator.

In January 1992 the International Conference on Water and the Environment led to the Dublin Statement on water and sustainable development. The four guiding principles of the Dublin Statement were fresh water as a finite and vulnerable resource, essential to life, development and the environment; a participatory approach to water development and management; women as central player in water provision; and the economic value of water. This Statement introduced for the first time the idea of water as an economic commodity, meaning water should be priced.

In June 1992 the Earth Summit took place in Rio de Janeiro. The Dublin Statement provided the basis for Chapter 18 of Agenda 21 that looked at the Protection of the quality and supply of fresh water resources.

In December 1992 the General Assembly proclaimed 22 March of each year as World Water Day.

In 1994 the Ministerial Conference on Drinking Water and Environmental Sanitation was held in Noordwijk, the Netherlands.

The 1996 International Forum of Partner Cities for integrated water management was held in Montreal.

The First World Water Forum was held in Marrakesh in March 1997.

The United Nations General Assembly 19th Special Session (UNGASS) in June 1997 focused on the activities of the Commission for Sustainable Development; during this water was one of the major issues discussed.

The 9th World Water Congress on “Water resources outlook for the 21st century: Conflicts and opportunities” was held in 1997 in Montreal.

Public Service International (a confederation of hundreds of public service trade unions from across the world) adopted the Water Services Code in November 1997. This Code is based on the view of water as a human right.

The International Conference on Water and Sustainable Development took place in Paris in March 1998. This conference continued to reinforce the market-orientated approach to water use.

The UN Commission on Sustainable Development, created after the Rio Conference, gave increasing priority to water issues. This continued at its sixth session in April 1998.

In 1999 a draft of the World Water Vision (WWV) was released. Contributions to the WWV came mainly from the World Commission on Water, the World Water Council (formed by the World Bank in 1996), the Global Water Partnership, the

World Bank and water transnational corporations (TNCs). Their support for the commodification of water (which will be shown in Section 5.1) was reflected in the WWV.

Vision 21 of the Water Supply and Sanitation Collaborative Council aims to ensure water services to all within 25 years. It stresses the need for the participation of all and a holistic approach to water management.

The Second World Water Forum (SWWF) (arranged by the World Water Council, formed by governments, international institutions and the private sector in 1997) took place in March 2000 in the Hague.

In December 2000 the International Water Conference was held in Bonn, Germany. The first draft of the World Water Development Report was produced for Bonn. It was submitted to the Third World Water Forum in 2003. It focused on developing assessment methods.

In July 2001 the Blue Planet Conference took place in Vancouver to promote a global water revolution. It considered alternative ideas to the commodification and privatisation to water.

The International Conference on Fresh Water took place in December 2001 with the aim of strengthening the objectives of Chapter 18 of Agenda 21 as preparation for discussions around fresh water at the World Summit on Sustainable Development in 2002 in Johannesburg.

From these series of events, an evolution in thinking about water and development becomes apparent, which can be summarized in the following points²²:

- a) The decentralisation of government functions is being stressed. The principle of subsidiary has been accepted (Dublin Statement and Chapter 18 of Agenda 21), referring to the devolution of the management of water resources to the lowest appropriate level. The role of government has also shifted from providing water to providing a legislative and regulatory framework, a so-called enabling environment (New Delhi Statement).

The importance of the participation and the empowerment of local communities have also been acknowledged. This means those user communities such as water user associations and river associations should participate in water management. Especially the role of women in water management was acknowledged in both UNGASS and SWWF. However, there is a need to build capacity at a local level to

22 Rooyen, C. Water as a factor in socio-economic Development: Future Trends. Department of Anthropology and Development Studies, RAU, South Africa. <http://www.unl.org/unldoc/EOLSS/E2-25-03-03-TXT.aspx>.

manage water resources: education, training and skill development are part of this. But this does not mean that, for example, farmer-management irrigation systems and indigenous management systems should be overlooked. Local level institutions for water management should be based on local reality.

The role of the private sector in the management of water has increased. This increased role is directly related to viewing water as an economic commodity (started with the Dublin Statement). This increased role can be seen in the growing private sector investment in the water sector in developing countries between 1990 and 1997 of around \$2,500 million. Currently about \$7,800 million is spent on water supply and sanitation worldwide, although the World Bank estimates that the global water market is worth about \$80,000 million. Because of private sector investment focusing on a “fair” return on investment, it has provided finances for water supply infrastructure in mainly urban areas. Especially in developing countries water services are also being privatized, with pressure for this being exerted on these countries by the World Bank and the International Monetary Fund (IMF). The growth of the private sector involvement in water services has especially been in water TNCs.

The financial aspects of water provision are about cost-recovery policies or “economic pricing” for water services. This means that water users must pay for all the costs related to water systems, including capital expenditure, costs of operation and maintenance (O&M). The tendency is to acknowledge the need for equity measures to ensure access to “sufficient” water for all, but then to argue against the “burden” of subsidies that should not rest on the service providers. The central question, though, is whether cost-recovery can ensure the right to water of all, especially the poor.

An integrated, holistic approach to water resource management is central to the sustainable use of water and to development. The Dublin Statement, Chapter 18 of Agenda 21 and the 1994 Ministerial Conference stressed this. An integrated approach means that economic, social and environmental factors should be considered in water management. But it also implies that surface and groundwater should be seen as a holistic whole that must be managed together, many times across state boundaries.

If this is how water and its role in development are currently viewed, what can we expect of the future?

The historical analysis of the water developments has clearly demonstrated that the availability of water influenced the pattern of economic development in Kenya. All of Kenya’s major cities, municipalities and most of its towns are located where water can be extracted for human consumption, as well as for productive uses. Water is an important input to almost every industry. Throughout Kenya’s water history, the link between water availability and agricultural production has been repeatedly

demonstrated. Hence, water is clearly essential for Kenya's economic prosperity. However, Kenya is characterised by extreme climatic variability.

The emergence of these problems has raised concerns that the availability of water could place a constraint on economic growth. Some would argue that these constraints are already emerging. There is a related concern amongst some in the community that because of the scarcity of water continued economic growth can only be achieved at the expense of the environment.

However, the finite nature of our water supplies does not have to imply reduced economic growth or ongoing environmental degradation. Rather, the fact that water resources are scarce means that water, like other limited inputs to economic production, needs to be used efficiently and allocated to its highest value uses in order to improve both economic and environmental outcomes. Under this argument, the historical analysis clearly demonstrates the current allocation of water in Kenya and concludes that it is unlikely that water is currently used or allocated efficiently. This means that there is scope to improve the allocation of water in such a way as to achieve economic growth and ensure water for the environment.

Although it is known that economic growth affects water supply and some changes are predictable and easy to measure within the existing management set up, others are unknown, unpredictable, and are difficult to incorporate them in terms of overall planning.

Comprehensive analyses carried out by the world Centre for Water Management clearly indicates that projects like Bhakra Nangal in India, High Aswan dam in Egypt and Ataturk dam in Turkey have radically transformed the economic growth patterns of the regions concerned by generating new employments, enhancing food and food security conditions and improving major social indicators. Economic growth rates affects have a major implications in terms of access, quantity, quality, equity and management and investment requirements of water supply.

The period under review saw Kenya experience unprecedented political and socio-economic transformation, from a delimited entity, to colonial state to an independent nation state. This period had Kenya encounter deep political socio-economic reorganisation and progression²³.

The entry of colonial powers in 1895 saw a beginning of transformation from subsistence to agriculture based, service and industrialized economy. The need to penetrate the interior led to building of railways that transversed the protectorate from Mombasa town to Kisumu. There was migration of workers from rural areas to townships and other areas with industries. The demand for water increased with

23 Biswasa A.K., Tortajada C., Izquierdo R (2009). *Water Resources Development and Management: Water Management in 2020 and Beyond*-Spring-Verlag Berlin Heidelberg, 2009.

consequent development of water supplies to serve the settlements, the administrators and for industrial use. Some of the major water supplies developing as a result included the Mrere springs supply in Mombasa, and Nairobi water supply from Kikuyu springs²⁴.

Water use challenges particularly in economic, agriculture and accompanying challenges led to development of the first water law. The drafting of the first water legislation started in 1914²⁵.

The economic recession of 1921 led to redirection of resources otherwise meant for water development to recovery of economy. Essentially this was a negative driver for the water supply in the colony²⁶.

The period preceding 1930s saw a concentrated development of agricultural farming and consequent development of various water supply programmes including dam building, piped water supply, irrigation and general water conservation measures. During independence, the colonial powers relinquished the wheels of the economy to the Africans and priorities of water development focused more on rural areas than the prior concentration on urban areas. There was collaboration between the government and bilateral partners who brought financial and technical assistance.

As the country's economy continued to grow in 1980s, more water supplies were put in place and more ambitious vision crafted to supply water for all by the year 2000. However, the vision eventually became a mirage with the economic recession of late 1980s and 1990s, and cost sharing, private public partnership and reduced spending on public services were witnessed. Equally, operation and maintenance of the already developed water supplies became the major challenge to the progress²⁷.

During 1990s, there was optimism that water supply and wastewater management problems would be solved by the private sector. It was expected to bring in additional investment funds and good management expertise that the public sector was lacking. After some time the private companies have lost their enthusiasm to invest in water sector during the post 2000 period. Thus, an important aspect of any future private sector involvement in the water sector has to be separation of short term blips from the long-term trends²⁸.

24 Biswasa A.K., Tortajada C., Izquierdo R (2009). *Water Resources Development and Management: Water Management in 2020 and Beyond*-Spring-Verlag Berlin Heidelberg, 2009.

25 British East Africa Protectorate (1923). *The water ordinance*, Crown Advocates Department. Kenya National Archives, Ref: AG/43/87. Nairobi, Kenya.

26 East Africa Protectorate (1923). Crown Advocates department. *The Water Ordinance*, Ref; AG/43/87, Kenya National archives.

27 Nyanchaga E.N & Ombongi K.S (2007). *History of Water Supply and Sanitation in Kenya, 1895-2002*. Environmental History of Water, Chapter 21. IWA Publishing, Alliance House, 12 Caxton Street, London UK.

28 Biswasa A.K., Tortajada C., Izquierdo R (2009). *Water Resources Development and Management: Water Management in 2020 and Beyond*-Spring-Verlag Berlin Heidelberg, 2009.

Economic growth should help preserve environment and decrease pollution, water included should also improve the living conditions of the average citizens significantly. The growth should improve income distributions in the areas under development and the whole country at large. However, even in scenario of robust economic growth, increased income and improved environmental quality are not always related since more affluent countries and better of citizens do not automatically protect environment²⁹.

4.2 Population and Urbanisation

Some demographers predict that the world population will peak at around 9.4 billion by 2070. With water consumption doubling every 20 years, such a growing population will add pressure to already stressed water systems. Most people, about 80 per cent of the world population, will be living in developing countries. As was indicated earlier, these countries already experience tremendous water scarcity; one in three people live in countries that are considered to be water-stressed or water scarce. By 2025 this will have grown to two-thirds of all people. One should be careful though not to fall into the trap of blaming too much on population growth – the highest population growth is in poor countries and the majority of people live there, but this is not where the largest amounts of water is consumed. It is rather in the rich countries with advanced technology and industrialisation. One example can highlight this: a child living in a rich, developed country consumes on average 50 to 60 times more water than a child living in a poor country³⁰.

Quint³¹ reported that in the Lower Colorado River Basin, population growth has been staggering. Between 1990 and 2000, the state of Arizona's population increased by more than 40 per cent and the population of state of Nevada increased by 60 per cent during the same decade. The population increase placed more and more demand on the water infrastructure. Competition for water is increasing because of this rapid population growth, but it is also being driven by chronic drought, environmental needs, energy needs, and climate change.

29 Biswasa A.K., Tortajada C., Izquierdo R (2009). *Water Resources Development and Management: Water Management in 2020 and Beyond*-Spring-Verlag Berlin Heidelberg, 2009.

30 Rooyen, C. *Water as a Factor in Socio-Economic Development: Future Trends*. Department of Anthropology and Development Studies, RAU, South Africa. <http://www.unl.org/unldoc/EOLSS/E2-25-03-03-TXT.asp>.

31 Quint, R. J. (2007). *Future Water Challenges*. Bureau of Reclamation. International Commission on Irrigation & Drainage. Sacramento, California. October 3, 200.

Quint³² concluded that the solution to water needs does not end with ample amounts of water. What is necessary is a combination of supply, efficient infrastructure, and the cooperation of people working together to ensure that needs for water are met.

Population growth is a fundamental driver of natural resource stress in Kenya. Kenya's increasing population is straining the ecological systems that provide water for drinking, agriculture, and other life-sustaining services, while causing a rapid increase in land degradation. Related demographic challenges, including higher consumption lifestyles underscore the urgent need to plan for increasing demands on water resources.

Rapid urbanisation in Kenya will present a new set of water management challenges in the coming decades.

Asian urban centres with populations of 500,000 or less will constitute a staggering 27% of the global population by 2015, posing even bigger challenges than megacities. Unless greater attention is focused on resolving the water problems of small urban centres, these areas are likely to become "major water and wastewater black holes of the future."

Water challenges are acute in China, where economic growth and urbanisation rates exemplify the trends of higher demand and new water use patterns that are common in the Asian region. Forecasts for the next 15 to 20 years see continued mass migration from Kenya's rural areas to the cities, which is likely to exacerbate the current challenges of water pollution and supply shortage. Nationwide, the demand for water in Kenya's urban areas is growing by more than 10% annually, and it is expected to increase 40% by 2020.

Tied in with population growth is increased urbanisation in especially developing countries. By 2025 about 54 per cent of the population in developing countries, and 84 per cent of developed countries, will reside in urban areas. Twenty-one cities already have over ten million inhabitants, 17 of which are in developing countries. Five hundred million people are expected to live in cities in 2025. The inadequate infrastructure in huge cities like Sao Paolo, Mexico City and Lagos will be further strained by such rapid urbanisation. The lack of reliable water supply and adequate wastewater disposal and treatment will increasingly become a problem³³.

With urbanisation comes an increase in industrialization. Current industrial and urban uses of water in Europe, for example, are already 55 per cent of total water

32 Quint, R. J. (2007). *Future Water Challenges*. Bureau of Reclamation. International Commission on Irrigation & Drainage. Sacramento, California. October 3, 2007.

33 Rooyen, C. *Water as a Factor in Socio-Economic Development: Future Trends*. Department of Anthropology and Development Studies, RAU, South Africa. <http://www.undl.org/unldoc/EOLSS/E2-25-03-03-TXT.aspx>.

use there; the expectation is that this will double by 2025. But the biggest growth in industries is expected in developing countries. This will lead to increases in water demand for manufacturing and for energy. This increased demand for industrial water use will continue to deteriorate the quality of water. Although much of the water used for this can be re-used, its quality degrades with each use and recycling. The pollution of water with toxic chemicals by industries impacts negatively on freshwater eco-systems and holds health hazards for people³⁴.

Worldwide, population has been a driver for the water sector. As the Kenyan population increased, more additional quantities of water to sustain the inhabitants at a reasonable standard of living were required. Kenyan population increased over the years with varied growth rates. In terms of water management, population has many other implications.

Initial water supplies were developed along the Uganda Railway line where there were settlements along the railway stations. Mombasa, Nairobi, Nakuru, Naivasha and Kisumu towns' water supply developed as such. It was in this railway satiation that workers lived travellers rested and the water demand was high and as a consequence more investment in the water supply and development³⁵. The population in settlement schemes, in labour estates where sisal was grown and processed, and coal mining industries was very high, this led to increased water demand the issue of water supply development was considered central to progress.

Generally, the population of Kenya kept on growing and after independence, areas with high population density receive more attention in supplying them with water. Areas with high population density created high water demand and the government prioritized areas with higher demand. The growth of population resulted in development of more water supplies; the graph below illustrates this interdependence:

A census was carried out in 1907, and the results showed that the town had a total population of 13,514, the Europeans and Eurasians being 642, Goanese 510, Indians 3,071 and Africans 9,291. This result was however doubtful as several hundred Indians and Africans were believed to have escaped enumeration, owing to a well-founded impression in the Indian bazaar that the question of serious overcrowding there was likely to be taken in hand ones the results of the census were known³⁶.

34 Rooyen, C. Water as a Factor in Socio-Economic Development: Future Trends. Department of Anthropology and Development Studies, RAU, South Africa. <http://www.undl.org/unldoc/EOLSS/E2-25-03-03-TXT.aspx>.

35 Chairman's Report (1957). Nairobi Peri – Urban Water Supplies. Kenya National Archives, Ref: WAT/ 36/24/212, Nairobi, Kenya.

36 Williams G.B (1907). Report on the Sanitation of Nairobi and Report on the Townships of Naivasha, Nakuru, and Kisumu. Kenya National Archives, GP, 363.7.BRI. 1907.

Water supplies were: the private water supplies at Chromo in 1899, Kikuyu springs inn 1906³⁷, Amoretti borehole 1930, Ruiru dam 1938, Nairobi dam 1946, the Sasumua dam in 1950s, Thika dam 1993 and continuous augmentation works to satisfy the Nairobi population³⁸.

In concentration camps and prisons where population was high, the demand for water was high and consequently water supply was considered a prerequisite for every of these institutions. In Kisumu, the Kisumu new prison water supply which had an intake form the lake, Nyabondo water supply, new prison Kodiaga water supply, Nyahera and Tamu water supplies were the major supplies³⁹.

4.3 Changing Management Practices

In reflecting on the development and management phases, several trends are evident. There has been a change in community values and an increase in environmental awareness. The focus has shifted from a preoccupation with water quantity to a focus on water quality. There is now an increasing need to involve all stakeholders in sound decision-making processes. Of recent, there is an increase in discussions on the importance of sustainability and the need to balance social, economic and environmental values.

The various WSB organisational values reflect the current status of these changing trends. The following values as noted by Flett⁴⁰ are also cited in the business and strategic plans of these new water institutions:

- Customer service and efficiency: Highest priorities.
- Co-operation: Based on shared visions and alignment is the key to progress.
- Openness: Builds trust, knowledge and understanding.
- Sustainability: Commitment to future generations.
- Integrity, respect and pride: Valued characteristics of our people.
- Continual improvement: Essential and underpins the future.

37 Williams G.B, (1907). Report on the Sanitation of Nairobi and Report on the Townships of Naivasha, Nakuru, and Kisumu. Kenya National Archives, GP, 363.7.BRI. 1907.

38 Japan International Cooperation Agency (1992). The Study on The National Water Master Plan: Sectoral Report (D), Domestic and Industrial Water Supply. Ministry of Water Development. Kenya.

39 Canadian Development Agency (1980). Rural Water Supply Western and Nyanza Provinces: Task 2 Report, Nyanza Province, Inventory and Assessment of Existing Water Supplies, project No. 52400519. Nairobi Kenya.

40 Flett, D (2003). Water Management for the Future – a contentious issue. Address to the Rural Press Club of Victoria. Goulburn-Murray Water, Australia. 29 May 2003.

With the development phase complete, a shift to a management phase of water resources was evident in the 1980s, and in many ways will always continue. There was structural change, with devolution of authority closer to customers and further from government. Government commitment to change was of fundamental importance to progress during this phase⁴¹.

Political leadership shape the direction and magnitude of general development of every country. The progression of Kenya was significantly influenced by the political regime of the day. So much the political leadership affected Kenya's development that the policy, legislations and the implementation of plans and programmes succeeded only if they had a political goodwill. It is along these regimes that varying levels of investments in water supply were appropriated. Equally, the areas of prioritisation were determined by the political establishment in existence.

The colonial government concentrated on development of urban water supplies, administrative centres, police stations and detention camps. On the other hand, after independence, the African government adopted a policy of-water for all by the year 2000. The independent Kenya encouraged bilateral partnership to water development; Danish, Finnish, Dutch, Canadian, Swedish governments and World health Organisation were major development partners in this field. The political leadership of the day encouraged policy papers, improved the water law and oversaw implementation of various water supply systems.

Post independent period beginning in 1980s saw the adoption of cost sharing policies paired with heavy private sector investment in water supplies and eventual privatisation of existing major water supplies through the water companies. Despite having initial successes, private sector participation in water supplies has adversely affected accessibility of the essential commodity to the urban poor.

4.4 Type of Development and Globalisation

The type of development or development path followed influences the demand for water. It also is a factor in determining how water issues and challenges are dealt with.

As people's basic needs are met and people modernize and industrialize more, they demand more water for usages other than consumption and sanitation. This is evident from the fact that most water consumption is taking place in rich, industrialized, modern countries. For example, to make one car withdraws around 400 000 litres of water. But such a development path for all is not sustainable, considering

41 Flett, D. (2003). Water Management for the Future – a contentious issue. Address to the Rural Press Club of Victoria. Goulburn-Murray Water, Australia. 29 May 2003.

the scarcity of water. Gandhi said, “There is enough for everyone’s needs, but not for everyone’s greed”. One might therefore argue that in these rich countries there are overconsumption and excessive waste of water. To use fresh water for washing cars, swimming pools and watering lavish gardens, while millions lack clean water, seems harsh and inhumane. If poor countries are to follow this path of development, to which they are encouraged, the use of water will not be sustainable. One of the issues to be addressed then is the overconsumption of water by some, while others underuse water. Modernisation and industrialisation have other very negative environmental impacts, leading to global warming, with glaciers melting, rising sea levels and some scientists speculating about the changing precipitation patterns⁴².

Globalisation, or more accurately corporate-led globalisation, is enforcing this universal model of development on all. Neo-liberalism, which underpins the current process of globalisation, leads to public goods and commons being replaced by individual responsibility. In this process the role of the state is being changed by liberalisation and there is a growing trend towards the commodification of water and its privatisation. Water is more and more seen as a productive element and economic good that should be traded for profit. The growing external debt of the developing countries; and refusal to cancel this debt; act as a hindrance for increased government spending on water and sanitation⁴³.

Part of this globalisation is the speed of the development of new technology. Especially technology development like biotechnology (for example genetically-modified organisms), better storage technology around dams and reservoirs, communication and information technology, technology improvements for the pumping and transportation of ground and surface water, the reclamation of used water and desalination technology, should affect the use, availability and quality of water. However, technology should not be seen as the miracle worker that will solve all water challenges, simply because the future challenges is not all of a technical nature⁴⁴.

In Europe as in the rest of the world, the issue of sustainability is becoming intermingled with the general debate related to globalisation. Will better management of both resources and services be reached through public institutions, or through privatisation? Legitimate criticism of large state run water projects developed in the 1950s and 1970s and related supply-side policies, has fostered a — chiefly An-

42 Rooyen, C. Water as a factor in socio-economic Development: Future Trends. Department of Anthropology and Development Studies, RAU, South Africa. <http://www.unl.org/unldoc/EOLSS/E2-25-03-03-TXT.aspx>.

43 Rooyen, C. Water as a factor in socio-economic Development: Future Trends. Department of Anthropology and Development Studies, RAU, South Africa. <http://www.unl.org/unldoc/EOLSS/E2-25-03-03-TXT.aspx>.

44 Rooyen, C. Water as a factor in socio-economic Development: Future Trends. Department of Anthropology and Development Studies, RAU, South Africa. <http://www.unl.org/unldoc/EOLSS/E2-25-03-03-TXT.aspx>.

glo- Saxon — view that emphasized the merits of privatisation and water markets, accompanied by concessions of public services to private companies. However, after a dozen years of excitement, the prospects for these two types of privatisation do not seem as encouraging as they did at first⁴⁵.

Several years of experience leads us to reject the amalgamation of the two issues of privatisation of water resources (opening the way to water markets), and privatisation of water services, because the two do not function within the same legal or economic framework. Besides, developing countries cannot be compared to developed countries, since the former do not possess basic infrastructure, while the latter are facing only the long-term maintenance of an infrastructure already installed earlier⁴⁶.

In addition, we have discovered that, both as regards resources and services, the European experience is quite different from a straightforward confrontation between public versus private, or between state owned versus market regulated. Water resources are increasingly considered as common property, to be shared reasonably and equitably between users, both within member EU States and internationally⁴⁷.

Also, in the water services domain, a vast diversity of public–private formulas blur the traditional dichotomy between regulators and regulated. Let us first summarise the situation of water rights and water administration in some member States.

Global issues played a key role in development of water supplies in Kenya. The economic recession of 1921 led to shortage of raw material, high inflation and lack of funds to drive forward the train of water development. This followed the World War I that caused shortage of steel used to make buckets for latrines which in turn affected availability and usage of bucket latrines⁴⁸.

The attainment of independence was a conglomeration of various global factors among them external pressure from non-colonialists, and USA. There was a wave of colonial powers giving up their grasp over the protectorates to allow the Africans attain independence. The attainment of independence critically influenced the amount, direction and utilisation of water resources.

After independence, the trend was that developed nations assisted the developing nations technically and financially in social economic development. Water supply

45 Barraqué, B. (2003). Past and future sustainability of water policies in Europe. *Natural Resources Forum* 27 (2003) 200–211.

46 Barraqué, B (2003). Past and Future Sustainability of Water Policies in Europe. *Natural Resources Forum* 27 (2003) 200–211.

47 Barraqué, B (2003). Past and Future Sustainability of Water Policies in Europe. *Natural Resources Forum* 27 (2003) PP200–211.

48 Ling A.P (1947). Steel Imported Latrine Buckets. Kenya National Archives, BY/29/40, Ref: SAN. 913/56/Vol.11. 17th Mach 1947.

was a major beneficiary of this assistance through the Bretton Woods Institutions and the United Nations, DANIDA, SIDA, CIDA among others⁴⁹.

4.5 Technological Advancement

The journey to the present water supply situation has been a stair case of technological steps. From crude technologies where water was carried on shoulders⁵⁰ to the current fully operational automatically metered piped supply, each step has had an influence on development of water supply. The manual drilling of borehole using rings that took months compared to today fully mechanize drilling that takes hours, has positively influenced the development of water supply. From the usage of hand driven pumps, hydraulic pumps, diesel pumps, to electrical pumps, the trend in water sector development has experienced shifts in progression.

However, all these drivers have been responsible for responsible for underdevelopment of water supply. For example, technology requiring extra investment in machinery and personnel was in some instances rejected after a lot of resources had already been spent. Metre usage for instance discouraged locals from using water leading to inability to maintain the water supply system; in some instances locals could only use piped system during drought and revert to fetching from rivers after drought. Privatisation of water supply systems has had mixed outcome, succeeding in some places while becoming a total failure in others.

49 World Health Organization (1975). Report of the Review Mission for the Water Supply, Sewerage and Pollution Control "Sectorial Study" for Kenya. Kenya National Archives, BY/33/72. 1975.

50 Colony and Protectorate of Kenya, (1927). Report of the Local Government Commission 1927, Vol 1 Nairobi and its Environs and Mombasa and its Environs. K. 352. 1927.

CHAPTER FIVE

5.0 THE FUTURE OF WATER SERVICES

This chapter tries to identify the change strategies that can be most usefully adapted and applied in different temporal, bio-physical and institutional contexts. It is also envisaged that the analysis could act as a stimulus tool to spearhead discussion and debate on the potential attributes of future water services in Kenya. Facilitating a clear and agreed vision for a more sustainable future water services will assist with identifying the capacity development and institutional reform needs for expediting the transition to an effective water service delivery.

Continuing its commitment to address water issues, and recognizing the challenges and opportunities facing Kenya now and in the future, the country needs to turn attention to water as it is already a water stressed country. Kenyans expect a safe and reliable water supply to support the country's diverse and increasing population, sustain its varied economic interests and preserve their wonderful quality of life now and for future generations. Kenyans demand certainty that water will be available to support both consumptive and non-consumptive uses including when they turn on the tap, open irrigation pipes, and visit recreation areas and to sustain natural habitats.

The country must address regional concerns while improving water quantity and quality. Regardless of the varying regional expectations and goals, water is going to become more expensive.

Unless there are radical thinking and quick actions, predictions are there will be 400 million people by 2025 that lack access to clean drinking water. In 1950 12 countries faced water shortages; by 1990 it has increased to 26 countries; and by 2050 it might be 65 countries. The problems all people will face and challenges faced are unique to specific contexts, and will continue to be so in the future. Four

broad and general, but closely related, future challenges can be identified. However, the impact of these forces will vary from context to context. These are population growth, urbanisation, the type of development, and poverties and inequalities.

The first two relate strongly to the availability and quality of water, the third to how water is used, while the last challenge is about power relations and access to water. Evident from this will be the growing competition between the different uses of fresh water¹.

Supplying water of adequate quality and in sufficient quantities is one of the major challenges facing Kenyan society now. The available water reserves are already overexploited to such an extent that the negative consequences can no longer be ignored. The situation in the provision of water services will become even more critical in the years ahead.

The SAM study² summed up that the development of the water market is being shaped by four megatrends:

- a. Explosive global population growth. Demand for water is soaring, and not just to cater for the personal needs of individuals. In the coming years even more water will be needed to produce food for the world's burgeoning population.
- b. In many countries the infrastructure for supplying the population with drinking water and wastewater treatment is badly run down. Major investments will therefore be required in the short term to upgrade ageing water mains and sewer systems in particular.
- c. Higher standards for water quality. One major priority is to ensure that people living in developing and newly industrialized countries have access to clean drinking water. Added to this, solutions also need to be found to meet the fresh challenges arising from new micro pollutants that are becoming a problem in industrialized countries especially.
- d. Climate change will cause significant variations in the hydrological regime in many regions, culminating in a water crisis in some areas.

These megatrends will intensify the pressure to manage existing water resources far more efficiently in the years ahead. The associated investments will inevitably have an impact on the markets in question. This situation opens up attractive opportunities to all businesses offering products and services for the treatment, supply or use of

1 Rooyen, C. Water as a factor in Socio-Economic Development: Future Trends. Department of Anthropology and Development Studies, RAU, South Africa. <http://www.unl.org/unldoc/EOLSS/E2-25-03-03-TXT.aspx>.

2 Wild, D., Francke, C., Menzli P. and Schön U (2007). Water: A Market of the Future. SAM Study. December 2007.

water. Those companies that are capable of offering sustainable solutions stand to benefit the most.

In the Kenyan situation, there are three ways in which demographics will affect water consumption:

- The country's population will continue to grow in future.
- More and more people are moving from the rural into the urban centres usually because of a real or perceived lack of employment opportunities in the rural area. Similarly, the number of towns and urban centres is increasing rapidly in many areas. These towns are growing not just in number, but also in size.
- General living standards are improving country wide.

Based on an analysis of the current situation and an assessment of future market demand, SAM³ identified four investment clusters that promise attractive upside potential:

- **Distribution and management:** Companies active in this cluster offer solutions for upgrading water mains and sewer infrastructure, develop systems for supplying fresh water and removing wastewater, act as utilities, or are involved in the management of water resources.
- **Advanced water treatment:** This cluster includes companies which play a key role in the disinfection of drinking water, the treatment of wastewater or the desalination of sea water, or which provide the necessary control systems and analytical instruments.
- **Demand-side efficiency:** This cluster includes companies offering products and services that boost the efficiency of water use in households or industry.
- **Water and food:** Companies in this group develop products that improve water efficiency and reduce pollution in crop irrigation and food production, or are involved in the production of bottled water.

5.1 Overview of stages of the Water Development

The evolution of water services technologies in Kenya can be sketched in three consecutive stages, separated by crises:

3 Wild, D., Francke, C., Menzli P. and Schön U (2007). Water: A Market of the Future. SAM Study. December 2007.

1. In the first stage, reservoirs and aqueducts are developed by civil engineers to bring ever greater volumes of water from ever more distant sources. Eventually, this technology came to support national government interventions into large multipurpose hydraulic schemes. But water transfers generate conflicts with other users; also, the water may be contaminated.
2. At some point, this technology is found more costly and more risky than pumping water from rivers just upstream of the city and treating it (filtration, and later chlorination, ozone, GAC (granular activated carbon) beds) before distribution; this is made possible by the rise of chemical/sanitary engineering, which also allows solutions to be found to treating wastewater before it is discharged into rivers. This is the second stage — in fact quite supportive of the local character of water services.
3. Even the chemical engineering response may be reaching its limits: as water quality standards are rising, it is becoming too expensive to produce drinking water from increasingly polluted water resources. This is the third stage, where environmental engineering will assist the movement toward integrated river management, demand-side management, and pollution control at the source.

5.1.1 Quantitative Supply-Side Policies and Water Transfers

In the 19th century, or rather until the discoveries of Robert Koch and Louis Pasteur were popularised, public water supply services were developed on the assumption that water should be drawn from natural environments far from the cities. Large cities in particular would have to get water from further and further away. Financially, this was possible because municipalities were able to obtain ‘cheap money,’ in particular through the popular early savings banks, which they controlled. Municipal bonds were attractive to the public, and on top of it all, governments would subsidise water supply projects.

5.1.2 From Quantitative to Qualitative Supply-Side Policies

Large cities in western and northern Europe changed path back in the beginning of the 20th century. Rising population densities and shrinking natural resources worked to increase competition for clean water, while the concurrent development

of biochemical analysis brought to light serious levels of contamination. As irrigation was not necessary, the main problem here was with water quality rather than quantity: to deal with the sanitary problems, it was decided (by the end of the 19th century) that water should always be filtered. Soon afterwards, chemical treatment was invented: chlorination, ozonisation, UVs, and filtration through GACbeds (around the time of WWI). Large European cities then turned to the rivers flowing through them, extracted water just upstream of their location, and treated it. This technology did improve public health, while reducing investment in infrastructure. That is, investment shifted from the long distance pipe to the treatment plant. This strategy, however, entailed a considerable rise in operational costs, which in turn gave rise to the idea of having customers pay the operational costs through issuing water bills. Over time, the delivery of water under pressure into private homes reached universal coverage, thus changing the status of public water supply from that of a luxury to an expected standard convenience, while clearly improving the self-financing capacity of utilities.

5.2 Current Challenges

The future of water management is a highly contentious issue. At no time in recent history has the importance of water to our communities had greater emphasis. Water is one of nature's five gifts – along with air, soil, energy from the sun and biodiversity – and water management is a vital part of managing our natural resources⁴.

Although many parts of the country regularly experience drought, many Kenyans do not understand the critical nature of Kenya's water challenges. In the short term, all Kenyans must be educated about the severity of the issue, supply limitations and potential solutions. In essence, Kenyans need to become water literate.

Other short-term challenges include drought response, voluntary water transfers and cooperation between public and private entities, tribal communities, etc. Many of these issues also are long-term challenges.

To avoid crisis management, Kenya must engage in long-term planning based on good science and data collection that should be made widely available throughout the country. A country wide water assessment plan, taking into consideration regional needs, must be produced by the various regional water institutions and local policymakers. The nationwide drought plan should be prepared, adopted and implemented by the regional water service institutions. Planners must evaluate what

4 Flett, D. (2003). Water Management for the Future – a Contentious Issue. Address to the Rural Press Club of Victoria. Goulburn-Murray Water, Australia. 29 May 2003.

levels of population can be sustained by the available water supplies. Further research and development of new technologies should be part of the long-term strategy to improve water supplies.

Continuing efforts to reduce uncertainty requires resolving water rights disputes, identifying supplies and uses and estimating population growth. Such efforts are necessary to develop and implement both long and short-term goals. Hence, Kenya now must address both short and long-term challenges.

Developing flexible regulation that encourages sustainable and innovative behavior, companies respond to the signals and demands of government and regulators. For companies to deliver the new agenda, regulation needs to evolve from a position where it is detailed and focused on complete compliance, to a position where it is risk based and focused on issues which are material to customers or other stakeholders⁵.

Specific changes in regulatory behaviour that may result in more sustainable outcomes, greater innovation and lower regulatory costs, include⁶:

- an acceptance of potential for compliance failure where innovative sustainable solutions are being implemented but are not guaranteed to succeed,
- penalties for failure which balance rewards for success,
- demonstrating that decisions taken clearly fit within government policies and strategies,
- setting compliance standards having demonstrated that the benefits to be achieved outweigh the costs – including the carbon and social costs – of delivery,
- making greater use of price signals – for example by developing a more flexible abstraction and discharge charging regime, with variable prices which reflect the environmental costs actually imposed at specific times or locations,
- greater clarity on which regulatory body is responsible for policy decisions such as those relating to balancing demand and supply,
- the application of materiality tests to regulatory reporting, and
- Lighter touch regulation for companies with strong track records, and transparent and robust reporting systems.

5.2.1 Water Supplies

Sustainability of water supplies should be the primary goal of the water services boards. This should go in line with the general definition of sustainability as “the

5 Water UK (2010). Meeting Future Challenges. A Blueprint for Policy Action. June 2010.

6 Water UK (2010). Meeting Future Challenges. A Blueprint for Policy Action. June 2010.

ability of current generations to meet their needs without compromising the ability of future generations to meet their needs”.

Past predictions of water supply and demand have been inadequate at best. It has been generally accepted that the collection and dissemination of information about water supplies and demand is a national concern and must be improved. The water services regulatory board is by law responsible for the dissemination of such information. Thus, adequate and sustained funding must be provided for such efforts.

5.2.2 Available Water Options

Water Conservation: The existing water supply infrastructure is in a very dilapidated state in all WSBs with large volumes of water being wasted through leakage. In that respect, water conservation offers an immense opportunity as the most important method to increase the longevity of existing water sources. Conservation requires comprehensive public education beyond slogans and sound bites in order to create a culture of conservation. Societal values must adjust to desert and arid region realities. Hence, conservation should be a duty of all water users regardless of water availability. Mandatory use restrictions and other conservation measures may be necessary in times of water shortage.

A national water conservation framework should be put into place, with local communities developing specific conservation plans. Plans should take into consideration the various economic interests in each region, for example tourism and agricultural uses. Local water policymakers should develop baseline conservation goals, measure progress and establish trigger mechanisms to implement mandatory practices if voluntary conservation is not adequate.

General access to water must remain affordable. Alternative pricing structures should be explored and developed to allow basic access and discourage waste. Institutional barriers, such as certain inflexible ACC policies, currently undermine such efforts.

Financial incentives for conservation should be offered for low water use landscape modifications and installations, conservation easements and new technologies. Policymakers should evaluate existing water subsidies and not reward wasteful practices.

Pricing of water, to reflect its long-term cost, recognizing existing contract requirements, is the most effective conservation tool. Consideration should be given to step and block pricing as a tool of conservation. Incentives, not penalties, should be offered to encourage conservation.

Recycling water and efficient use of effluent must be encouraged and enforced in accordance with the WASREB guidelines. Although expensive, recycling has proven to be a useful technology. The quality of recycled water should be improved to expand its potential use.

Public awareness and education about the safety of water treatments could lead to use of recycled water for human use.

Existing regulations should be amended or new regulations adopted to allow expanded use of quality recycled water.

Water Management: Effective water management can be attained based on the flexibility to adapt to the needs of particular geographical regions. The various water services boards must recognize that their decisions impact other regions. Hence, WSBs should evaluate their procedures in light of balancing population growth and water supplies.

While water shortages have prompted many communities to better manage their resources, it is imperative that communities plan for water shortages before they occur. To avoid crisis management, the WSBs must play a bigger role in water management and be proactive. It should immediately implement a comprehensive water storage and recovery planning process. It must have the necessary funds, staffing and resources to accomplish its goals. WSBs also can encourage conservation and facilitate cooperation between water service providers.

Management policies should encourage conservation. Where appropriate, market forces should be allowed to reflect the long-term cost of water and promote its efficient use. Management policies should ensure accurate data collection and information dissemination throughout the WSBs jurisdiction.

The current water service providers have already adopted management market approaches for negotiations and new strategies to solve water disputes in the last five years since the reforms started, thus breaking deadlocks and stalemates that had been insurmountable until recently. While still timid, the effects of these diverse initiatives are accumulating in a rich social capital, which will likely pave the way for settlements on a larger scale. At the national and regional levels, the disputes have not subsided, with some CAs requesting that more inter-basin transfers should be built, and some others claiming full rights on all resources running within their jurisdiction.

Water Allocation

The currently effective “Guidelines for Water Allocation (WRMA, First Edition, March 2010)” conforming to the Water Act 2002 stipulate the requirements with regard to water allocation and prioritisation, as follows⁷:

1. The water demands to be taken into account for water allocation are ecological needs, basic human needs (BHNs), water for which commitments have been made in international treaties and inter basin water transfers, and water that can be allocated to individual uses by means of a permit.
2. All users of water resources other than the reserve consisting of the ecological and basic human needs, international obligations and inter-basin transfers are authorized according to the criteria of equitable allocations.
3. The reserve commands the highest priority in terms of water allocation.
4. The domestic water has a higher priority than other uses as stipulated in the Water Act 2002.

With respect to all the other types of demands, the Water Act 2002 is silent with respect to priority, although various considerations must be made in regard to: i) existing lawful uses; ii) efficiency and public benefit; iii) commitments or priorities stated in the Catchment Management Strategies; iv) potential impacts on other water users and the water resources; v) the class and resource quality objectives; vi) existing and future investments by the applicant; vii) strategic importance of the application; viii) quality of the water resource which may be required for the reserve; and ix) probable duration of the water use activity⁸.

On the basis of the requirements of the WRMA Guidelines for Water Allocation and results of discussions with MWI and WRMA, as well as current situations surrounding water allocation, natures of the water demands, and so forth, the policies of water allocation adopted in the National Water Masterplan are set as illustrated in Table 5.1.

7 Ministry of Environment, Water and Natural Resources Water Resources Management Authority (2013). The Project on the Development of The National Water Master Plan 2030. Final report. Volume - VI Sectoral Report (3/3). October 2013. Japan International Cooperation Agency. Nippon Koei co., ltd.

8 Ministry of Environment, Water and Natural Resources Water Resources Management Authority (2013). The Project on the Development of the National Water Master Plan 2030. Final report. Volume - VI Sectoral Report (3/3). October 2013. Japan International Cooperation Agency. Nippon Koei co., ltd.

Table 5.1: Prioritisation of water allocation for NWMP 2030

Priority	Water Use
1	Reserve consisting of ecological and basic human needs
2	Existing water uses for domestic, industrial, irrigation and hydropower, and existing inter-basin transfer water (International obligation to allocate water is not considered, because there is no international commitments so far.)
3	New domestic and industrial water uses
4	New livestock, wildlife and inland fishery water uses
5	New irrigation water use
6	New hydropower generation use

Source: Ministry of Environment, Water and Natural Resources Water Resources Management Authority (2013).

The reserve amount was set at 95% value of the naturalised daily flow duration curve for each river in accordance with WRMA Guidelines for Water Allocation and the probability applied is one in 10 years which was determined based on the discussion with WRMA.

Regarding trans-boundary water resources, NWMP 2030 includes development of trans-boundary water resources as an input to achieve the Kenya Vision 2030. The development of trans-boundary water resources should be undertaken with treaties and agreements with neighbouring countries in line with the Trans-boundary Water Policy currently under formulation by MWI⁹

Balancing Economic and Population Growth: Water needs to be recognized as a key factor in managing growth in both urban and rural areas. Continuing pressure for growth is a fact of life. At some point, the exceptional quality of life enjoyed in the world may be affected unless new populations can pay for the water resources required to support them.

Environmental and Quality of Life Issues: Water management should be approached in a multi-faceted manner that include producing quality water, restoring and sustaining healthy ecosystems and providing recreational uses, while also addressing the needs of agriculture, industry and domestic water users and water providers. These goals will require increased levels of funding to meet higher costs.

Quality of life and healthy natural environments are mutually dependent, not mutually exclusive. Comprehensive, multi-use watershed planning is essential to

⁹ Ministry of Environment, Water and Natural Resources Water Resources Management Authority (2013). The Project on the Development of The National Water Master Plan 2030. Final report. Volume - VI Sectoral Report (3/3). October 2013. Japan International Cooperation Agency. Nippon Koei co., ltd.

assure a sustainable water supply for human use while maintaining a healthy natural environment such as preserving the natural flow in our remaining river systems, including the Verde, San Pedro and Upper Gila Rivers. In-stream groundwater recharge programs can concurrently support riparian preservation and recreational areas.

Current Resources: A number of effective programs and institutions, staffed with talented people, exist at the various water sector institutions to address water needs. However, these resources are inadequate to resolve current and future challenges. The ministry must play a central leadership and advocacy role. The ministry's national mission in the areas of policy development, planning and data collection should be strengthened. The sector's strategic plan should be implemented by local policymakers on a regional basis. The ministry should lead in the national conservation campaign.

New Infrastructure: The Water UK¹⁰ indicates that the cost and availability of capital is arguably the biggest single issue the water industry faces. The sector is, and will remain cash flow negative and will require on-going refinancing. The cost of capital is the single biggest influence on customer bills.

The industry has clearly been successful in raising capital, and there is little indication that this position will change in the near future as¹¹:

- In accepting price controls existing equity holders accepted, at least implicitly, that they would provide a third of the finance required for new investment;
- The conventional bond market is open, and prices are reasonable; and
- Other key lenders such as the European Investment Bank indicate that they will continue to support the sector.

This should not be taken as complacency on the part of the industry. The cost of finance is higher, and its availability lower, than in the past. Equity returns may be acceptable now, but only because companies remain able to pass on to shareholders the low debt costs that were incurred in the first part of the last price control period.

Existing infrastructure should be improved and maintained. Additional physical infrastructure required to assure adequate quality and water delivery include the following: pipelines, storage facilities, the means to deposit and recover recharged water and recover storm-water, more and improved water treatment and transfer facilities, and additional monitoring equipment.

10 Water UK (2010). Meeting Future Challenges. A Blueprint for Policy Action. June 2010.

11 Water UK (2010). Meeting Future Challenges. A Blueprint for Policy Action. June 2010.

Proper funding is necessary for physical infrastructure. The cost of any new infrastructure should be evaluated in light of its anticipated benefits. Cost analysis should include anticipated future maintenance costs.

Regulators cannot assume that capital will be available when it is required. Investors have choices and many opportunities to place their money. For example, just within the UK infrastructure market, it has been estimated that over £400 billion will need to be invested by 2020. The water industry will need to compete hard if it is to obtain the capital it requires. Crucial to the outcome will be the balance between reward and risk, particularly regulatory risk¹².

New Information and Planning Resources: While significant information and planning resources exist in most water sector institutions, there are some major data gaps. There is a need for improved collaboration among the various holders of available information. Public officials often lack necessary information to make effective water management decisions. Local officials often lack funding for travel to training or the ability to bring the expertise to their community for education of those in leadership roles.

In order to plan effectively, more information about population growth, state-wide water plan assessment, supply and demand, the nature and quality of resources must be obtained. Additionally, WSBs needs to complete more studies and provide more information to users and planners. Regular monitoring activities also must improve.

Possible futures: Each of the external water drivers is dynamic and continues to evolve, as do the direct and indirect pressures they exert on water resources. Thus, it is difficult to draw a comprehensive picture of the future by examining each driver independently.

Because the drivers can have even more of an impact on future water resources collectively than they can individually, future scenarios that consider these interactions offer a more holistic picture. Existing global water scenarios are outdated, incomplete sectoral and do not fully incorporate each of the external drivers. The evolution of the drivers and the logic behind their storylines need to be examined and possibly redefined in view of developments both inside and outside the water sector that have occurred over the past decade.

Using water: History shows a strong link between economic development and water resources development. There are abundant examples of how water has con-

¹² Water UK (2010). Meeting Future Challenges. A Blueprint for Policy Action. June 2010.

tributed to economic development and how development has demanded increased harnessing of water.

Steadily rising demand for agricultural products to satisfy the diverse needs of growing populations (for food, fiber and now fuel) has been the main driver behind agricultural water use.

The effects of water-depleting and water-polluting activities on human and ecosystem health remain largely unreported or difficult to measure, and the need grows stronger for effective protection of ecosystems and the goods and services they produce – on which life and livelihoods depend. As competition among demands on water increases, society will need to respond with improved water management, more effective policies and transparent and efficient water allocation mechanisms.

Water's many benefits: Water has always played a key role in economic development, and economic development has always been accompanied by water development. Investment in water management has been repaid through livelihood security and reductions in health risks, vulnerability and ultimately poverty.

Water contributes to poverty alleviation in many ways – through sanitation services, water supply, affordable food and enhanced resilience of poor communities faced with disease, climate shocks and environmental degradation. Water of the right quality can improve health through better sanitation and hygiene and, when applied at the right time, can enhance the productivity of land, labour and other productive inputs. In addition, healthy freshwater ecosystems provide multiple goods and services essential to life and livelihood.

The importance of water services is especially apparent in societies where normal social life and political structures have broken down. In these fragile states the government cannot or will not deliver core functions to most of its people, including the poor. While each fragile state is fragile in different ways and for different reasons—war, post-conflict recovery, major natural catastrophe, prolonged mismanagement and political repression— a striking commonality in reports from aid agencies is the prominence of water and sanitation in relief and reconstruction programmes. The rapid restoration of viable water services is often crucial ingredient of nation-building in these fragile states.

Evolution of water use: The earliest water supply systems represent the first modern urban water systems in Kenya, reflecting the colonization of Kenya by the British in the late 1890s.

The normative underpinning at the time was the effective provision of safe and secure water supplies for growing urban population, and centralized provision

particularly for the elite where the social movement of cleanliness was strongly linked with social status. Much of the cognitive faculties used to address these norms, were imported from the British hydraulic engineering profession, with key engineers brought to Kenya from the UK. This influenced the planning, construction and management of centralized urban water supply schemes including the extraction of large quantities of water (from what was considered a benign environment) through building of some dams and pipe systems to supply large quantities of water. Once the capacity for such systems was secured, there was a strong normative development that the perceived 'limitless fresh water' should be a public right and delivered by governments (like those in the UK) at a very low cost to ensure that the poor and other disadvantaged groups could have equitable access.

While most of the old challenges of water supply, sanitation and environmental sustainability remain, new challenges such as adaptation to climate change, rising food and energy prices, and ageing infrastructure are increasing the complexity and financial burden of water management. Population growth and rapid economic development have led to accelerated freshwater withdrawals.

Trends in access to domestic water supply indicate substantial improvement in the past decade, putting most countries on track to achieve the water supply target of the Millennium Development Goals. However, sanitation is lagging well behind, and most sub-Saharan African countries and many rural areas still show unsatisfactory records for both water supply and sanitation.

Steadily increasing demand for agricultural products to satisfy the needs of a growing population continues to be the main driver behind water use. While world population growth has slowed since the 1970s and is expected to continue its downward trend, steady economic development, in particular in emerging market economies, has translated into demand for a more varied diet, including meat and dairy products, putting additional pressure on water resources.

After agriculture, the two major users of water for development are industry and energy (20% of total water withdrawals), which are transforming the patterns of water use in emerging market economies.

Water and energy share the same drivers: Steadily increasing demand for agricultural products to satisfy the needs of a growing population, and the desire for a more varied diet, continues to be the main driver behind water use. Demographic, economic, social and technological processes put pressure on both energy and water. The recent acceleration in the production of biofuel and the impacts of climate change bring new challenges and add to the pressures on land and water resources.

Freshwater ecosystems provide an extensive array of vital services to support human well-being. A variety of economic and recreational activities such as nav-

igation, fisheries and pastoral activities depend on direct use of water in healthy ecosystems. Yet some environmental services receive inadequate policy attention and are endangered by the way development sectors use water.

Impacts of water use on water systems and the environment: The pattern and intensity of human activity have disrupted – through impacts on quantity and quality – the role of water as the prime environmental agent. In some areas depletion and pollution of economically important river basins and associated aquifers have gone beyond the point of no-return, and coping with a future without reliable water resources systems is now a real prospect in parts of the world.

While the intensity of groundwater use, partly encouraged by subsidized rural electrification, has led to the emergence of many groundwater-dependent economies, their future is now threatened by aquifer depletion and pollution. Prospects for relaxing use of these key aquifers, remediating water quality and restoring groundwater services to ecosystems look remote unless alternative management approaches are developed.

Our ability to maintain the environmental services we depend on has improved but remains constrained by an incomplete understanding of the magnitude and impact of pollution, the resilience of affected ecosystems and the social institutions that use and manage water resources systems. A failure to monitor the negative impacts of water use on the environment and institutional weaknesses in many developing countries prevent effective enforcement of regulatory provisions.

Relevant information about pollution loads and changes in water quality is lacking precisely where water use is most intense – in densely populated developing countries. As result, the often serious impacts of polluting activities on the health of people and ecosystems remain largely unreported. Still, there are signs of progress in how pollution and the risks of pollution can be mitigated and trends in environmental degradation reversed.

Managing competition for water and the pressure on ecosystems: Competition for water and shortcomings in managing it to meet the needs of society and the environment call for enhanced societal responses through improved management, better legislation and more effective and transparent allocation mechanisms.

Challenges include wise planning for water resources, evaluation of availability and needs in a watershed, possible reallocation or storage expansion in existing reservoirs, more emphasis on water demand management, a better balance between equity and efficiency in water use, inadequate legislative and institutional frameworks and the rising financial burden of ageing infrastructure.

Water management choices should emerge from informed consultation and negotiation on the costs and benefits of all options after considering basin interconnectedness, relationships between land and water resources, and the consistency and coherence of decisions with other government policies.

The development of water services in Kenya inevitably needs to take into account of the following issues among others:

5.3 Water and the Economy

History shows a strong link between economic development and water resources development. There are abundant examples of how water has contributed to economic development and how development has demanded increased harnessing of water. Such benefits came at a cost and in some places led to increasing pressure on the environment and increasing competition among users. Our requirements for water to meet our fundamental needs and our collective pursuit of higher living standards, coupled with the need for water to sustain our planet's fragile ecosystems, make water unique among our planet's natural resources¹³.

Over the coming years the economic importance of water will continue to increase for a number of reasons¹⁴:

- Global demand for water is soaring. To meet this demand, a whole range of water services need to be expanded and made to operate more efficiently.
- To meet the current challenges, enormous investments are required to upgrade and expand the water infrastructure.
- For poorer and rapidly growing nations in particular, new technologies need to be developed for treating, distributing and using water.
- It is unlikely that water can in future be made available for all applications at the same low cost as it is today. If the price of water does increase due to supply bottlenecks, this will have dramatic consequences for all areas of our lives that essentially depend on water. These areas include virtually all of society's commercial activities, from agriculture through to the production of everyday consumer goods.
- Companies that identify these changes at an early stage and consequently respond with appropriate measures in order to exploit the resulting opportunities will be better positioned in the market and will achieve greater commercial success.

13 The 3rd United Nations World Water Development Report: Water in a Changing World (WWDR- 3).

14 Wild, D., Francke, C., Menzli P. and Schön U. (2007). Water: a market of the future. SAM Study.

- Carry out sector wide approach by linking access to water with health and wealth creation as a means of demonstrating the contribution of water to good health, source of livelihood and general wellbeing. Highlighting of the benefits of reforms in water services provision from case studies of successful water provision companies should be undertaken.

5.4 Legislation and Policy

5.4.1 Hierarchy of Laws in Kenya

The hierarchy of Kenya’s laws starts with the constitution, followed by acts of parliament, rules and regulations, gazette notices, circulars, and bylaws. Table 5.2 illustrates the Hierarchy of Laws in Kenya.

Table 5.2: JICA study outcomes

Law	Body Responsible	Remarks
Constitution	The People of Kenya	For all concerned
Acts of parliament	Parliament	For all concerned
Rules and regulations	Ministry	For all concerned
Gazette notice	Ministry	For all concerned
Circulars	Ministry	For all concerned
By laws	County councils, municipal councils, city councils, urban councils, and registered organisations	The bylaws only affect those who are members of the organisations.

Source: Ministry of Environment, Water and Natural Resources Water Resources Management Authority¹⁵.

The Water Act 2002, No.8 of 2002 was assented on October 17, 2002. It was an Act of Parliament to provide for the management, conservation, use and control of water resources and the acquisition and regulation of rights to use water; to provide for the regulation and management of water supply and sewerage services; to repeal the Water Act (Cap 372) and certain provisions of the Local Government Act; and for related purposes. The act is composed of six parts including 114 Sections and five schedules. The Minister for Water and Irrigation made the Water Resources

¹⁵ Ministry of Environment, Water and Natural Resources Water Resources Management Authority (2013). The Project on the Development of The National Water Master Plan 2030. Final report. Volume - VI Sectoral Report (3/3). October 2013. Japan International Cooperation Agency. Nippon Koei co., ltd.

Management Rules 2007, Legal Notice No. 171 which is conferred by Section 110 of the Water Act 2002. The Management Rule is composed of 13 parts including 154 rules and 12 schedules.

The other acts related with the three main legal documents are the Agriculture Act, the Forest Act, Land Act, the Environmental Management and Coordination Act, the Irrigation Act, the Lakes and Rivers Act, the Electric Power Act, the Mining Act, the Wildlife Act, the Land Planning Act, the Local Government Act, the Fisheries Act, the Public Health Act, the Tana and Athi River Development Authority Act, etc.¹⁶.

5.4.2 Water Act 2002

Overall, the Water Act 2002 provides a sound basis for implementing water sector reforms, although there are some areas where it will need to be augmented if the policy reforms are to be effective. The three most important issues are institutional coordination, decentralisation, and financing water resources management. The Water Act 2002 still has its weaknesses, but a bigger problem than inadequate legislation and regulations is poor enforcement and compliance. If the Water Act 2002 ultimately provides the enabling environment for a simple and straightforward methodology for developing regulatory and institutional procedures then a number of the potential legal issues and hurdles will be resolved. The Water Act 2002 creates two statutory bodies, that is, the Water Resources Management Authority that is responsible for catchment management, water apportionment, pollution control and the enforcement of laws relating to water resources management; and the Water Services Regulatory Board (WSRB), which is the licensing body and economic regulator. Under the Act this regulatory board is an autonomous body with responsibility for regulating water and sewerage services in the Country.

The problem with the Water Act is that all the critical interventions in areas susceptible to monopoly power abuse appear to be totally emasculated. For instance, section 47(g) of the Act only gives the regulator the power “to develop guidelines for the fixing of tariffs for the provision of water services” whereas section 73(1) permits the WSBs to regulate themselves “a licensee shall make regulations for or with respect to conditions for the provision of water services and the tariffs applicable”. It should be made clear that water and sewerage services that have public

¹⁶ Ministry of Environment, Water and Natural Resources Water Resources Management Authority (2013). The Project on the Development of The National Water Master Plan 2030. Final report. Volume - VI Sectoral Report (3/3). October 2013. Japan International Cooperation Agency. Nippon Koei co., ltd.

interest issues in respect to matters of safety, cost, access and availability cannot be permitted to regulate itself.

Tariffs or any other regulation of the WSBs are subject to approval by the Regulatory Board, but there are no specific legal tests the Board can apply to accept or reject a set of tariffs or regulations. Even if the WSRB were to develop guidelines for tariff setting, the guidelines would not have the force of law and could easily be contested or rejected by licensees (WSBs) or their agents - the water service providers.

The upshot is that the Act fully exposes consumers to the rent seeking activities of monopolists. At the very least, the Act ought to be amended such that the WASREB can apply specific criteria to make judgments on the level and reasonability of tariffs charged by Water Service Boards.

The Water Services Regulatory Board has no independent source of funding. The Act only provides for the retention of revenues from license fees with the approval of the Minister and the Treasury. In this respect, decisions of the Board that displease the Minister or the Treasury can result in denial of funding.

A simply written policy briefing kit justifying the reforms and outlining their implementation process should be developed to support this effort. The kit should contain a simplified version of the Water Act and a description of the institutions established under the Act. The ministry's role in the sector is changing, from constructing water supply system in specific geographic areas to more policy oriented issues, and in response to the redefining the role of the Government, the private sector, non-governmental organisations and community-based organisations in the water sector.

5.5 Information Dissemination

A comprehensive communication intervention with a wide reach across all audience segments should be developed to increase knowledge and close knowledge gaps among all sectors of the population on water sector reforms and to correct misinformation and address misconception about the reforms.

Communication programmes should explain the rationale and problems that necessitate water sector reforms and that it is a government initiative aimed at improving the management and provision of water and not a donor driven initiative.

There is need to establish a strong network that would facilitate exchange of information and ensure effective implementation of the Water Act. Thus, consultation with various stakeholders is important to develop consensus and generate a sense of ownership amongst the populace in the water sector reforms.

Help organisations active in the water sector add on water reforms issues to their agenda by developing an ongoing platform through which they can participate in communication and mobilisation activities in a way that will be mutually beneficial to the water sector reforms and the audiences that they interact with.

5.6 Commercialisation of Water Services

There is need to have policy implementation for the effective commercialisation process to take off successfully. Advocacy approaches should be used to generate understanding and build support among policy makers across all government departments and related bodies on water sector reforms.

Commercialisation of water is an expensive venture, as it requires capital investment to enable supply to catch up and then keep pace with demand. To sustain reliable supply, continuous system maintenance is inevitable to enable any Water Service Provider to regain and maintain consumer confidence and achieve high revenue efficiency targets.

It is important to introduce and maintain a realistic cost recovery tariff that does provide the Water Service Provider with sufficient funds to operate and maintain the system in an optimum way. There is need to work towards a realistic level of unaccounted for water. With the old distribution system in most of the water supplies, achieving a figure of 25 percent in the short run is unrealistic.

Hall¹⁷ suggests that governments should always consider the public sector option before engaging a private partner. He recommends that the public option should be contracted and capability for reforms should be evaluated. The private proposal can then be evaluated against the public sector option, in a public and transparent process. During this process secret agreements and secrete contracts must be avoided and stopped. Considering and discussing these standards and principles is a starting point for constructive discussions among opposing parties in the public private partnership debate.

¹⁷ Hall, D (2001). *Water in Public Hands*. Public Services International Research Unit. London, UK.

5.7 Institutional Framework

New institutionalism is an active field of social research, concerned with understanding the processes involved in institutional change. As discussed by Healey¹⁸, institutions are expressed through both ‘hard’ and ‘soft’ infrastructure, where the ‘hard’ represents formal organizational structures, departments, formal committees, laws, taxes and subsidies, and the ‘soft’ institutional infrastructure includes the social relations, informal networks, administrative routines, professional cultures and social worlds. Institutions are defined by Scott¹⁹ as comprising three mutually reinforcing pillars that collectively shape patterns of practice: i) Cognitive - dominant knowledge, thinking and skills. An example of changing cognition in the water sector is the growing dialogue and thinking around Water Sensitive Urban Design (WSUD) which conceptually challenges traditional notions of water management; ii) Normative – values and leadership. An example of changes to values in the urban water sector is the growing focus upon the importance of environmental protection and the remediation of waterways; iii) Regulative – administration, rules and systems. Rules and systems are designed to protect dominant values (normative) and thinking (cognitive). The growing focus upon environmental protection and sustainability has seen the gradual introduction of legislation and regulation aimed at protecting natural water environments²⁰.

New Institutionalism reveals that the defining characteristic of institutions is their capacity for stability and to withstand attempts at being significantly changed over short periods²¹. For institutional change to successfully occur there must be a mutually reinforcing shift within each of the pillars of institutional practice. However, very often, change interventions aimed at fostering focus upon institutional reform through only one of the pillars. For example, change interventions are often focussed solely on education programs dealing with the cognitive aspect of institutional change but are not backed up by changes to how people value water (normative) or changes to the rules by which they must operate (regulative). In a similar fashion, sometimes regulation is introduced without adequate changes to thinking (cognition) and values (norms) and the regulation fails²². Usually, changes to thinking and values will occur prior to changes in regulation; however, regulation is largely determined by those

18 Healey, P (1997) Collaborative Planning, McMillan, London.

19 Scott, R.W., (1995) Institutions and Organisations. Sage Publications, Thousand Oaks.

20 Brown R., Keath N., and Wong T (2008). Transitioning to Water Sensitive Cities: Historical, Current and Future Transition States. 11th International Conference on Urban Drainage, Edinburgh, Scotland, UK, 2008.

21 Scott, R.W., (1995) Institutions and Organizations. Sage Publications, Thousand Oaks.

22 Brown, R and Keath, N (2007). Turning the Supertanker: Drawing on Social Theory to Enable the Transition to Sustainable Urban Water Management, Proceedings of the 13th International Rainwater Catchment Systems Conference and the 5th International Water Sensitive Urban Design Conference, 21-23 August 2007, Sydney, Australia.

stakeholders with the most formal institutional power²³. Figure 5.1 is a representation of institutional framework of water under the Ministry of Water and Irrigation.

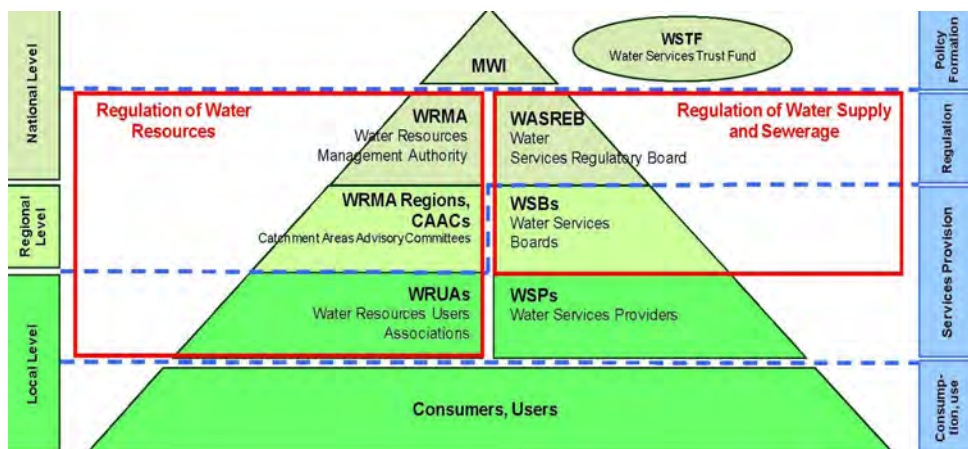

Figure 5.1: institutional framework under the ministry of water²⁴

Under a public governance structure decisions and management of infrastructure, capital investment, commercial risk, and operations and maintenance are taken on by a public entity for an indefinite period of time. Fully public management of water often takes place through national or municipal government agencies, districts, or departments dedicated to providing water services for a designated service area. Public managers make decisions, and public funds may be provided from general government revenues, loans, or charges. Governments are responsible for oversight, setting standards, and facilitating public communication and participation.

The Water Service Boards should be made up of members of the society who are strong-minded and make no compromises for effective transition. Representatives from NGOs and civil society bodies championing the rights of the poor should be proactively engaged to increase their understanding and support of the reforms. The various boards should have performance targets. Top management level should be appointed based on professionalism and expertise for effective management of the water companies. Consumer representation at the board level is important to instil

23 Brown R., Keath N., and Wong T (2008). Transitioning to Water Sensitive Cities: Historical, Current and Future Transition States. 11th International Conference on Urban Drainage, Edinburgh, Scotland, UK, 200.

24 Republic of Kenya (2011). Annual Water Sector Review Report 2010/2011. Draft Report of November 2011.

a sense of ownership amongst the communities and consumers. Figure 5.2 illustrates the newly formed water service boards²⁵.

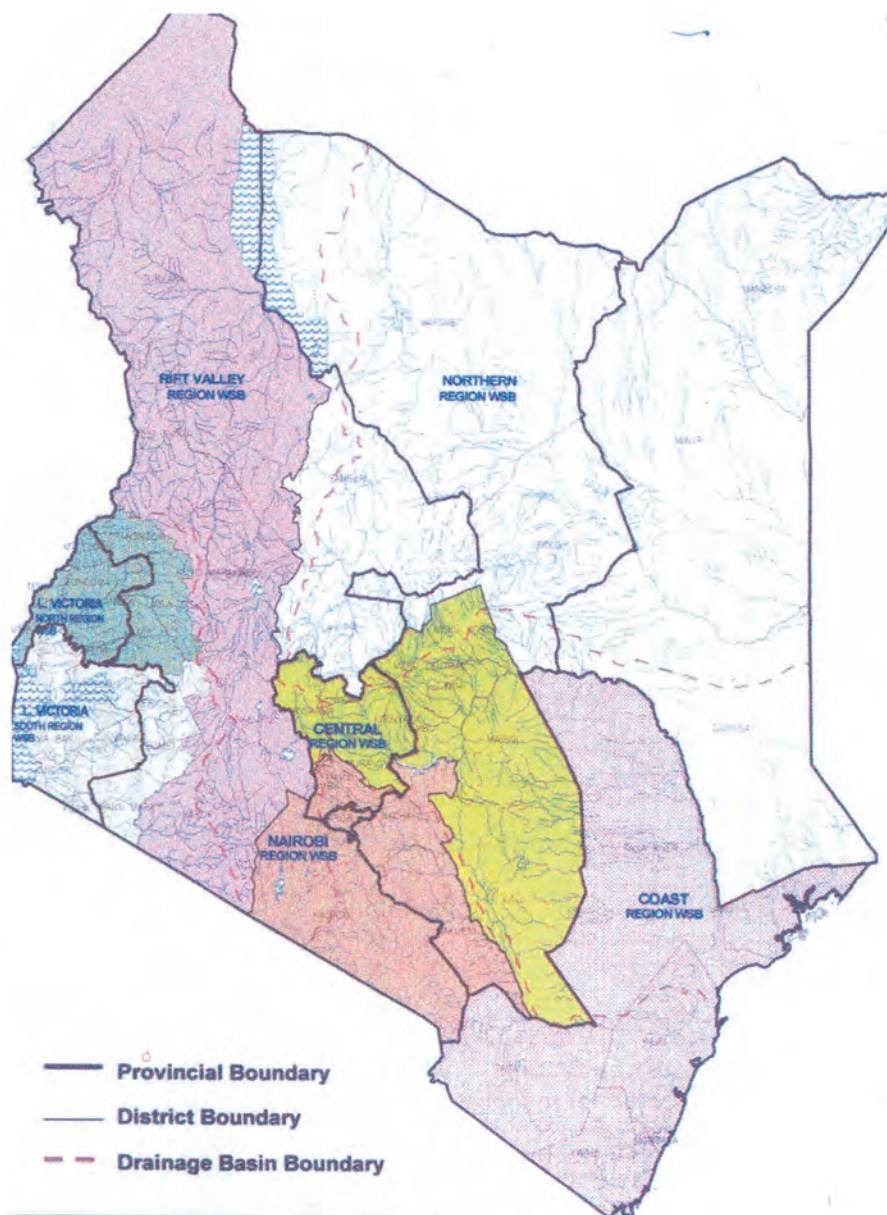

Figure 5.2: Water Service Boards in 2004

25 Government of Kenya (2004). Component Description for Support to Rural Water Supply and Sanitation. A project component of one of the Three Components of the WSPS, Jointly Supported by the Governments of Kenya, Denmark and Sweden .

There is need to depoliticise the water companies and give them the autonomy to run the companies as independent entities. As much as the autonomy is claimed on paper, it is not articulated on the ground. There is need to ring fence the established companies from political interference in order to successfully provide successfully sustainable water services.

Local authorities should understand that the water companies are their own agents and therefore any negative attitude or publicity towards the latter would only be detrimental to both parties.

As the country develops, water management and administration is being confronted with increasingly complex and multi-faceted challenges as societal expectations grow and natural resources reach the limits of sustainable exploitation. Given the significant climate change and the continuous population growth challenges facing Kenya, there is a critical need for strategic investment in solutions that will deliver long-term sustainable outcomes.

The historical analysis of the development, management and administration of water services over the last 100 years has enabled to identifying the attributes of more sustainable water services and the capacity development and institutional reform required to deliver the future water needs. It is hoped that the attributes will be used not only to facilitate dialogue and debate around the attributes of a future Water needs, but also as a benchmarking tool to assist strategists to identify those water institutions engaged in progressive transition strategies that can be learned from by other institutions.

5.8 Effective Governance

The GOK published the Kenya Vision 2030 in 2007, which is the country's new development blueprint covering the period from 2008 to 2030. The Vision 2030 aims to transform Kenya into a newly industrialised, "middle-income country providing a high quality of life to all its citizens by the year 2030".

The Vision 2030 is based on three pillars of development namely, economic, the social and the political. The economic pillar aims to achieve an average GDP growth rate of 10% per annum beginning in 2012. The social pillar seeks to build a just and cohesive society with social equity in a clean and secure environment. The political pillar aims to realise a democratic political system, and protects the rights and freedoms of every individual in Kenyan society. A plan for future of water supply is illustrated in the Figure 5.3²⁶

²⁶ Republic of Kenya (2011). Annual Water Sector Review Report 2010/2011. Draft Report of November 2011.

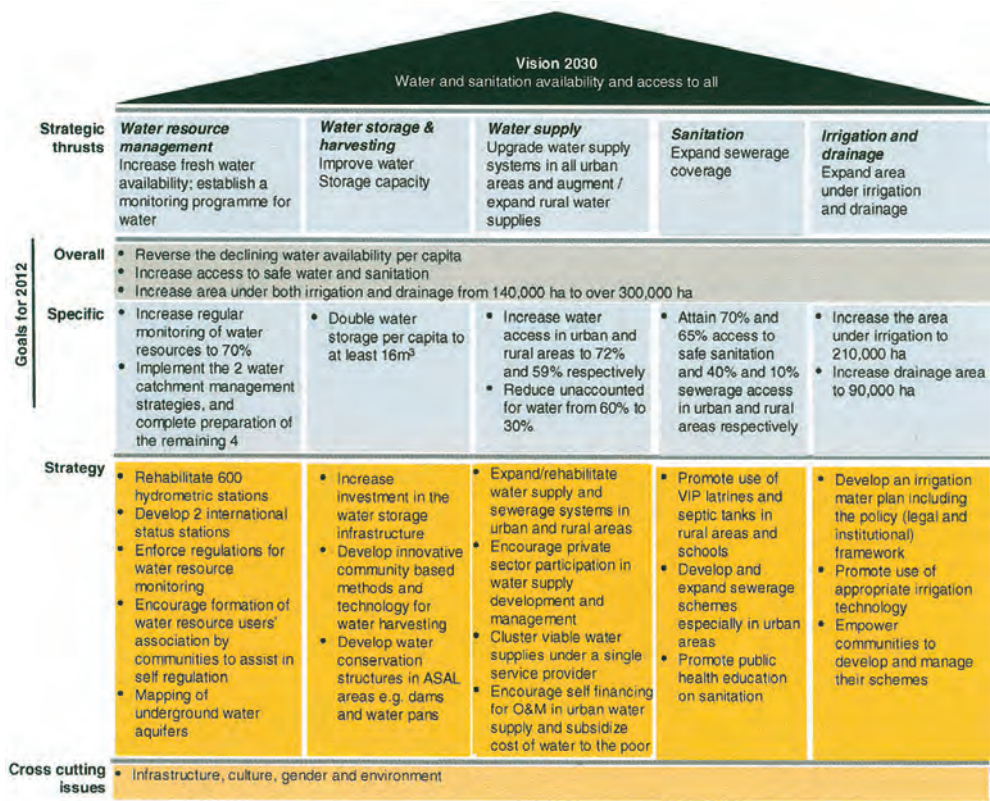

Figure 5.3: Water and Sanitation by the year 2030

The national development targets on the water sector in the Vision 2030 through the increase of access to water and addressing non revenue water²⁷.

Good governance within each country and at the international level is essential for sustainable development [6]. As a result of globalization, external factors have become critical in determining the success and failure of developing countries. The South Asian Water Vision 2025 stated that without addressing the issues of governance, policy and institutions, integrated development and management of the water resources for realizing a sustainable water vision in 2025 will only be an academic exercise. The Bonn Recommendation for action urges, “Water governance arrangement should improve accountability, introduce and enforce appropriate legal provisions against corruption, monitor the performance of public institutions and private companies, develop codes of conduct, and invite civil society to play an active role in these processes”.

Development effort cannot be effective, if it does not have the underpinning competent, capable and transparent institutions²⁸.

27 Republic of Kenya (2011). Annual Water Sector Review Report 2010/2011. Draft Report of November 2011.

28 Rahaman, M. M. & Varis, O (2005). The Ethical perspective of Water: Dilemmas and Future challenges, In: Afgan, N., Bogdan, Z., Duic, N. & Guzovic, Z. (Eds.): *Sustainable Development of Energy, Water*

Indeed it is a fact that without appropriate reforming towards good governance and institutions, an effective water resources management addressing the poor is impossible. Honest and efficient leadership and political commitment are vital for poverty reduction by sustainable management of all natural resources. In developing countries corruption is one of the main reasons for poverty. But who is responsible for corruption in developing world? What is the role of developed world in developing world corruption? Ethical consideration and analysis, reveals an unethical dual strategy and policy of developed world against corruption, one strategy for inside their own boundary and another for developing nations²⁹.

In Transparency International first Corruption Perception Report, states that, “Hand in glove with corrupt business people, political elites and their cronies are trapping the whole nations in poverty and hampering sustainable development”. Many developed countries are in many ways ethically responsible for the corruption in developing countries, although they are maintaining an honest, corruption-free system inside their own boundary. “Corrupt political elites in the developing world, working hand-in-hand with greedy business people and unscrupulous investors, are putting private gain before the welfare of citizens and the economic development of their countries” [20]. For example, according to Transparency International report, corruption perception index ranking of Australia is 10; at the same time Australia is number one according to bribe payer index rank. Which means Australia is maintaining a corruption-free transparent system inside its own boundary but Australian multinational companies are giving bribes to senior public officials and politicians of developing world to get business and other facilities from the emerging market economies of developing world.

These kinds of unethical dual strategies are enhancing the corruption in developing world³⁰.

At the crux of the water debate is governance and determining how to derive the most value from available water while not depriving people of their basic water needs. Water governance can be defined as the range of political, social, economic, and administrative systems that are in place to regulate the development and management of water resources and provision of water services at different levels of society. Countries face differing socio-economic, political, and historical contexts which will affect the way in which water resources and services are managed. However, according to Hall, most countries face a similar set of challenges and objectives with

and Environment Systems –Volume II, pp. 39-51 (University of Zagreb, Croatia).

29 Rahaman, M. M. &Varis, O (2005). The Ethical perspective of Water: Dilemmas and Future challenges, In: Afgan, N., Bogdan, Z., Duic, N. &Guzovic, Z. (Eds.): *Sustainable Development of Energy, Water and Environment Systems –Volume II*, pp. 39-51 (University of Zagreb, Croatia).

30 Rahaman, M. M. &Varis, O (2005). The Ethical perspective of Water: Dilemmas and Future challenges, In: Afgan, N., Bogdan, Z., Duic, N. &Guzovic, Z. (Eds.): *Sustainable Development of Energy, Water and Environment Systems –Volume II*, pp. 39-51 (University of Zagreb, Croatia).]

respect to water. All countries face the challenge of ensuring water infrastructure exists. Infrastructure issues include challenges such as reducing leakage, replacing and extending networks, and improving technology. As well, countries must ensure that the various social and political objectives surrounding water are addressed³¹.

These objectives include public acceptance, improving coverage, effectiveness, affordability, raising standards, ensuring transparency and accountability, and resolving international water disputes. Also, environmental and health challenges must be addressed.

Countries must address public health needs, environmental management, and the conservation of water. In addition, countries must make financial and managerial decisions regarding water undertakings. Financial objectives such as sustainable and equitable tariffs, effective revenue collection, financing investment and fiscal impact are decisions which must be made. Managerial objectives such as improving efficiency and productivity, evaluating administrative feasibility, capacity building, and efficient procurement must also be implemented. There are multiple responsibilities which a water and wastewater service provider faces. These include infrastructure and asset ownership, capital investment, commercial risk, and operations and maintenance³².

Moreover, water is a large bulky good, which often requires large capital facilities that exhibit economies of scale. The collection, storage, treatment, and distribution of water are often best served by a large reservoir due to the low average cost associated with economies of scale in the sector. This structural requirement entails that water is best organized as a 'natural monopoly'. Thus, government regulation of the water sector is inevitable, regardless of which form of governance is chosen. There are various governance arrangements. The choice regarding which management structures can face the above challenges, objectives, decisions, and responsibilities of a country can vary from a complete public solution, to a quasi-public solution, to a fully private solution³³.

The solution to the current and future water crisis will be found in changes to the way water is used and managed. Effective changes in water governance are the key to sustainable water management in the future. Physical, ideological, and international forces have encouraged public-private partnerships. Despite the promises of this form of governance, there have been gains and losses associated with its adoption. The current problems in governance structures cannot be ignored and a re-evaluation of the debate surrounding public-private partnerships is necessary. Future research and discussions should focus less on a dichotomous debate on partnerships and rather on a constructive debate on how, when, where and why public-private partnerships work. There is little research in the area of developing principles and standards for effective public-private partnerships. Public-private partnerships offer promise to the water sec-

31 Medalve, J (2008). Water governance. Water. Edited by Kundell, J. The Encyclopedia of earth.

32 Medalve, J (2008). Water governance. Water. Edited by Kundell, J. The Encyclopedia of earth.

33 Medalve, J (2008). Water governance. Water. Edited by Kundell, J. The Encyclopedia of earth.

tor as well as perils. The author recommends that future research efforts be channeled at developing effective standards for public-private partnerships in the water sector³⁴.

5.9 Sustainability of Water Services

If we apply the definition of sustainability (economic, environmental and ethical/Equity – three E's)³⁵ to water services — including both public water supply and public sewerage collection and treatment — the following three questions must be asked:

- How is capital maintained and replaced in the long term?
- What new investments are needed to improve the environmental and sanitary performance of existing systems?
- Is it politically acceptable to pass full sustainability costs on to consumers, and can they afford them?

In most of the existing water supplies, huge investments are now required in order to repair and upgrade the ageing infrastructure. Water supply and sewer systems have reached the end of their useful lives. Furthermore, the water mains are not being adequately maintained in some countries:

- The standard of maintenance for the water mains is far too low. Leaking pipes mean that large volumes of precious drinking water are wasted.
- There is a huge financing gap for the maintenance of drinking water and wastewater treatment facilities.

The water industry's success has been greatly assisted by stable and transparent regulation. The fundamentals of water regulation have largely been preserved since privatization in 1990 and are one of the underlying reasons why the industry has been able to attract the necessary investment and improve overall performance. While the basic regulatory framework is robust and should continue, it must also evolve to create incentives for the kind of solutions that will increasingly be needed. As changes to the framework are considered, it will be crucial to manage the risk of losing the support of customers or the capital markets on which the industry depends in order to fund investment in essential maintenance and service improvement³⁶.

34 Medalve, J (2008). Water governance. Water. Edited by Kundell, J. The Encyclopedia of earth.

35 Barraqué, B (2003). Past and future sustainability of water policies in Europe. Natural Resources Forum 27 (2003) 200–211.

36 Water UK (2010). Meeting future Challenges. A blueprint for policy action. June 2010.

5.9.1 Economic: Capital maintenance and replenishment

How is the enormous capital, accumulated in water services technologies over the past 150 years, to be maintained and reproduced in the long run? Are current depreciation schedules accurate? How are they reflected in the water bills or charges — particularly as Governments usually phase out subsidies after the initial investment? How does one balance the need to achieve excellent services (with a risk of overstaffing) on the one hand, and economizing on staff (and risking poor maintenance) on the other? Can normal maintenance needs be separated from needs arising from replacement of old infrastructure? Tracking water losses is a good example of this search for compromises.

There is obviously a maintenance optimum – which is certainly not zero-leaks – and relining leaky pipes is often cheaper than changing them. The question is how much of all this can be covered by water bills³⁷.

In the United States of America, the problem of aging infrastructure was a difficult challenge as the average age of a Reclamation project is 50 years; some projects approaching 100 years of age. The problem of how to address the enormous challenge of aging dams and infrastructures is one that, unfortunately, has no easy answers especially in this age of tight budgets and priority lists that don't seem to include a great deal of funding for addressing the issue. The realistic approach to addressing this conundrum most likely lies in establishing cooperative relationships with state, local, and tribal managers, as well as transparent relationships with the American public. Whether new projects or maintaining existing ones, the days of the large federal projects in the US were probably over. That doesn't mean there won't be projects; it means that localities will have to look beyond the federal government as a sole source of funding. But the battle over funding for improving and rehabilitating aging infrastructure continues at the federal, state and local levels³⁸.

There is still an integral federal role—but as a cooperating partner. Neither the federal government nor the localities can do it alone anymore.

5.9.2 Environment: New investments

The many different challenges surrounding the use of water resources in Kenya actually present a number of attractive opportunities for investors. Based on the global trends that will shape the water sector in the coming years, the main areas that can

37 Barraqué, B (2003). Past and Future Sustainability of Water Policies in Europe. *Natural Resources Forum* 27 (2003) 200–211.

38 Quint, R. J (2007). *Future Water Challenges*. Bureau of Reclamation. International Commission on Irrigation Drainage. Sacramento, California. October 3, 2007.

be identified for investment in the Kenyan situation that offer great potential for the future effective water services includes the following:

- 1) Distribution system and management
- 2) Advanced water treatment processes
- 3) Demand-side efficiency

According to SAM study³⁹, a successful investment strategy is based on three key principles: it complies with the basic principles of sustainability, it adheres to a set of general investment principles, and it takes the entire value chain into consideration. In the case of domestic water supply, for example, this includes a whole series of elements: forecasting natural disasters and providing protection against them; exploring, extracting and transporting water reserves; treating and disinfecting drinking water; distributing water to end consumers; measuring the volume of water sold; domestic water use; drainage into the sewer system; treating the wastewater in sewage plants; reusing the gray water for other purposes or channeling it back into natural watercourses.

If we look at the entire value chain, the spectrum of investment opportunities is actually very broad and encompasses companies which at first sight appear to have little direct connection with the theme of water, but are closely linked indirectly to the sector.

What kind of new investments are needed to improve the environmental and health performance of existing systems, and to comply with current EU directives and national standards? How much will operational costs increase (e.g., with increased volumes of sewerage)? What will be the additional cost burden on water consumers corresponding to rising investment and operational costs, in particular if loans have to bear commercial rates? How far are current national policies from the polluter-pays and user-pays principles, which have been formally accepted?

Demand-Side Efficiency

The ratio of present and future water demands to available water resources are presented in the Table 5.3. The future irrigation water demands for 2030 and 2050 are water demands for new irrigation development area of 1.2 million hectares targeted in Kenya Vision 2030 adding to the existing water demand⁴⁰.

39 Wild, D., Francke, C., Menzli P. and Schön U (2007). Water: A Market of the Future. SAM Study.

40 Ministry of Environment, Water and Natural Resources Water Resources Management Authority (2013). The Project on the Development of The National Water Master Plan 2030. Final report. Volume - VI Sectoral Report (3/3). October 2013. Japan International Cooperation Agency. Nippon Koei co., ltd.

Table 5.3: Available water resources and water demands by catchment area

Catchment Area	Available water resources and water demands (MCM/year)														
	2010					2030					2050				
	Water Resources (a)	Water Demand (b)	(b)/(a)	Water Resources (c)	Water Demand (d)	(d)/(c)	Water Resources (e)	Water Demand (f)	(f)/(e)						
LVNCA	4,742	228	5%	5,077	1,337	26%	5,595	1,573	28%						
LVSCA	4,976	385	8%	5,937	2,953	50%	7,195	3,251	45%						
RVCA	2,559	357	14%	3,147	1,494	47%	3,903	1,689	43%						
ACA	1,503	1,145	76%	1,634	4,586	281%	2,043	5,202	255%						
TCA	6,533	891	14%	7,828	8,241	105%	7,891	8,476	107%						
ENNCA	2,251	212	9%	3,011	2,857	95%	1,810	2,950	163%						
Total	22,564	3,218	14%	26,634	21,468	81%	28,437	23,141	81%						

Table 5.3 shows the seriously tight situation of water balance in Athi Catchment Area at present due to large water use as demonstrated by high water demand/water resource ratio of more than 40%. In the target year 2030, water demand will increase in all catchment areas, and water balance is expected to be tight in all areas. The catchment areas except Lake Victoria North Catchment Area will have large water deficits as predicted by the high water demand/water resource ratios of more than 40%, and the irrigation water demands corresponding to the irrigation area proposed by Kenya Vision 2030 need to be reduced⁴¹.

As for the water balance in 2050, the ratio between water resources and demand is almost the same as that for 2030 due to increase both of resources due to climate change and demand. However, the ratio is just for reference because of projection uncertainty for resources and demand.

The available water resources are a total of the renewable surface water resources and the sustainable yield of groundwater which are theoretically available quantities. As water resources are distributed unevenly in the country in terms of time and space, actual usable water resources are limited as demonstrated in Figure 5.4⁴².

The most efficient way to prevent overexploitation of available water resources is to invest in technologies that promote more efficient water usage. The traditional reliance on supply-led approaches is far from sufficient, but there is still time to avert the crisis by exploring innovative strategies and collectively making difficult trade-off decisions. The aim here is to achieve the same level of service with less water, without compromising on convenience and performance.

The future water businesses will require showing leadership on the issue, finding ways to leverage their core competencies, and to help shift water more firmly into the political and economic domains. Most importantly, there is a need to start somewhere. Everyone agrees there is a big problem, which is still within our collective means to fix. Business as usual is no longer an option.

To cope with the future water deficit, water resources development should be promoted to the maximum to meet the future water demand. Water demand management such as water saving and effective and efficient water use, recycling of water, etc. should be fully introduced to control water demand increase, especially it is important to control the irrigation water demand making up 80% of the total

41 Ministry of Environment, Water and Natural Resources Water Resources Management Authority (2013). The Project on the Development of The National Water Master Plan 2030. Final report. Volume – VI Sectoral Report (3/3). October 2013. Japan International Cooperation Agency. Nippon Koei co., ltd.

42 Ministry of Environment, Water and Natural Resources Water Resources Management Authority (2013). The Project on the Development of The National Water Master Plan 2030. Final report. Volume - VI Sectoral Report (3/3). October 2013. Japan International Cooperation Agency. Nippon Koei co., ltd.

water demand in the catchment area which has insufficient water resources for water demand. In addition, water resources development balanced with available quantity of water resources should be made.



Figure 5.4: Water Catchment Areas

5.9.3 Payment for Sustainability Costs

Looking at the budgetary allocation along the years, it's evident that sustainability would be very crucial in the sector. Since the commencement of the water sector reforms, the budget steadily increased a positive indication of growing interest to support the sector's development, from both the Kenyan Government and the development partners. The budget for the FY2010/11 was KES 38.6billion, an increase of KES 10billion from the previous year – an increase of 39%. In this regards, the development allocation increased by 41% while the recurrent allocation increased by 29 percent (Figure 5.5)⁴³.

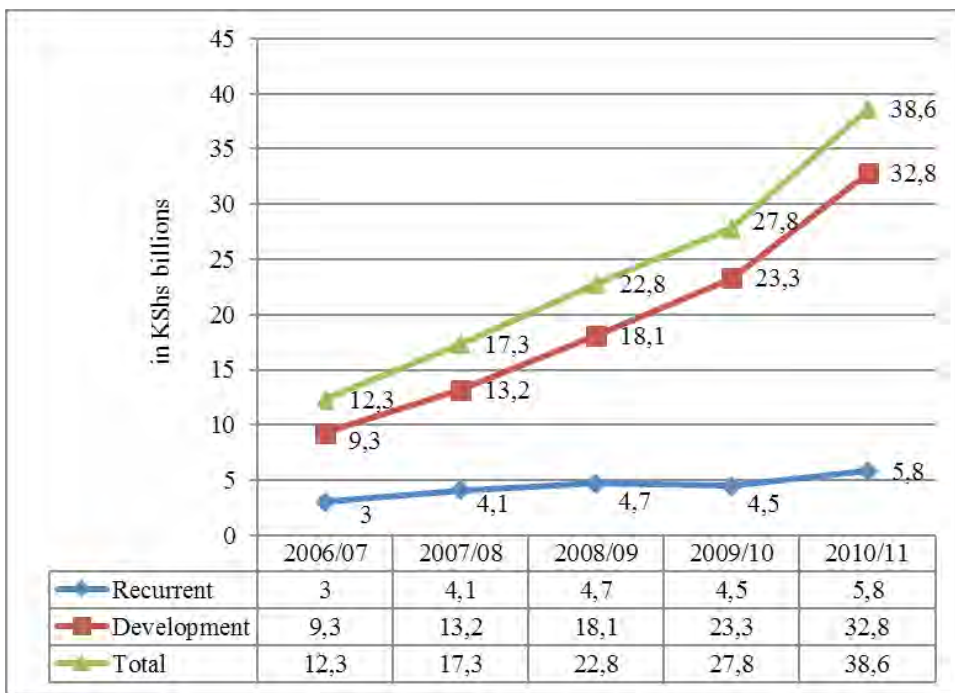

Figure: 5.5: MWI approved budget 2006/7 to 2010/11 (KES billions)

Overall the budgetary allocations to the water sector increased by more than 200% in the last five years (2006/07 to 2010/11). The development allocation increased by 252% while the recurrent budget increased with a growth rate of 93%. This

⁴³ Republic of Kenya (2011). Annual Water Sector Review Report 2010/2011. Draft Report of November 2011.

showed a commitment by the MWI to increasingly implement development activities while controlling spending on recurrent provisions⁴⁴.

If all the costs associated with environmental and economic sustainability are passed on to the consumers, can the lower income groups pay their bills? And is a high water price politically acceptable? If not, what kind of technological, financial or social adaptations are necessary? What would be the impact on future generations of today's poor replacement of infrastructure, in terms of higher prices and/or increased health and environmental risks?

Customers are concerned with the specific price they pay and the service they receive it is this which ultimately drives how they use water, and determines whether they can and will pay their bill. The majority of domestic customers continue today in relation to the old ratable value system with little, if any, incentive to use water wisely. This is despite the fact that in many parts the demand management will be increasingly important if we are to balance demand and supply and reduce the industry's carbon footprint⁴⁵.

If the country has to achieve sustainable management of water resources and avert a water crisis, water must be given a price tag that accurately reflects its vital role in the lives of Kenyans. It is therefore the duty of politicians and lawmakers to lay down the relevant rules and to push through measures that promote more sustainable use of water. This change of mindset has already occurred in those countries confronted with urgent water problems, whether in terms of quality or quantity, encouraging them to adopt the necessary laws, ordinances or budget allocations. But action is still needed at the political level, combined with a greater awareness by the general public of the importance of using water resources efficiently.

To make successful investments in the water sector, investors therefore not only need to be informed about the latest technical advances and industry solutions, but must also closely follow developments and decisions on the political and legislative front. The introduction of new environmental standards, tougher demands on water quality, more public spending on infrastructure construction and maintenance as well as the fixing of tariffs and fees, will have a significant impact on the growth of individual segments of the water market and, consequently, on the attractiveness of companies doing business in these segments.

In the years to come, water will develop into a dynamic market of the future. Given the global trends that are shaping the water market, demand is unlikely to drop off in the long term. While due account needs to be taken of company valua-

44 Republic of Kenya (2011). Annual Water Sector Review Report 2010/2011. Draft Report of November 2011.

45 Water UK (2010). Meeting Future Challenges. A blueprint for policy action. June 2010.

tions, investors with a long-term horizon can therefore expect to find numerous worthwhile and attractive investment opportunities.

Thinking about solutions for the immense water problems in Kenya might lead to similar conclusions, and different authors have postulated the need for a paradigm change in the water sector. There are tremendous investments required for adaptation and renewal of the water management systems.

The water professionals are certain that efficiency concerns would play a much more important role for future investments. However, they questioned the general sustainability of the current centralized water management system.

Water professionals, might now better understand the necessity of also taking radical system transformations and innovation management into account in order to focus on their common interest: an economically, environmentally, and socially sustainable water sector.

5.9.4 Cost Recovery and Subsidies

The first two E's, economy and environment, pose a challenge to local governments and water utilities, which in the past received subsidies to set up the initial infrastructure.

Now, even though investments to replace ageing infrastructure partly overlap with those to comply with environmental standards, in most countries, they add up to high levels while subsidies are increasingly phased out. OFWAT, the institution that Regulates water and sewerage providers in England and Wales, has estimated that if England and Wales were to rebuild their water services infrastructure completely, they would have to spend £189 billion. Some of these assets can be depreciated over 100 years, but others only over 30 or even 10 years. The issue is how much should be invested in each period of five or six years? And to what extent can this investment really be covered by consumers' water bills? Other European countries have to do this sort of analysis upon request of the EU Water Framework Directive, but the decentralized and thus smaller administrative units make it more difficult. Many experts think that we are just in the quiet process of 'eating' the initial capital, in particular as regards sewers. In the long run, the amount of investment needed is growing and will force countries to re-introduce subsidies so as to prevent an unacceptable rise in water bills. In a way, this is what happened in the UK. To make privatization attractive in 1989, the Government cancelled the debts of the previous

regional water authorities, and in addition offered a ‘green dowry’ to help the new companies live up to EU water quality directives⁴⁶.

Altogether, these subsidies — as anybody but the Thatcherites would call them — amounted to £6.4 bn. This is more than the French or German Governments have given to their water services over 20 years! But, if subsidies have to be brought in, either regularly or in lump sum, every 15 years, is there any future for privatisation? In her thesis, Karen Bakker⁴⁷ wonders whether British privatisation did not put the water industry into a fundamentally unsustainable state, which will be increasingly felt in the coming years — more than 20 years after it occurred. Some of the water companies are trying to sell their assets to water consumers or regional governments, since they do not want to be responsible for investments that depreciate so slowly.

5.9.5 Long-term Effect of Subsidies

In view of the above, the level of cost recovery is difficult to assess. If one wants to check present economic sustainability thoroughly, one has to look back 30 to 50 years. If subsidies are removed now, it will be at least another 20 years before the effect on water prices will be felt. Indeed, the case of the UK might in reality be a model of what is going to happen to all States in the wealthy core of Europe.

The situation may become even worse in southern and Eastern Europe, where most countries are currently still in the initial investment phase, receiving important state and EU subsidies. This means that prices are far below their cost-recovery level, as they were in the richer European countries at the time of their initial development of water services. Let us try to bridge this century-long process.

5.10. Are we facing a social reverse salient?

Before the business of providing public water supply moved into demand management and charge prices closer to real costs, water services were widely accepted by society. But it was because little attention was paid to demand. Water users had blind confidence in the system. Today, cost recovery brings prices up, while drinking water standards are getting stricter, and droughts are increasingly used to frighten people about possible water wars. Due to lack of information, in particular on the difference

46 Barraqué, B (2003). Past and Future Sustainability of Water Policies in Europe. *Natural Resources Forum* 27 (2003) 200–211.

47 Bakker, K (2003). *From Commons to Commodity? Privatizing Water in England and Wales*. Oxford University Press, Oxford.

between short-term and long-term sustainability, and on the real advantages of corporate management, there is a growing distrust among water users towards systems which had reached their equilibrium under the global municipality (and blind) type of welfare. If we are going to tackle the ethical crisis of water services, we will need more than just an economist's toolbox and good cheer. We need anthropologists, sociologists, historians, geographers, etc.⁴⁸.

In Southern Europe, the non-completion of the infrastructure made it impossible to raise prices to approach cost recovery, which has generated irrational allocation. Government subsidized hydraulic schemes clearly reduce the final prices paid by farmers and give no incentives to cities to conserve. The whole water economy is 'pulled downwards.' Indeed, farmers could actually make more money by not working, just selling their water. A parallel situation arose in California and gave rise to so-called 'water markets' in order to gain credibility. A water market would in fact not be necessary, if water resources allocations were allowed more flexibility through community and catchment-based water institutions.

But again, overall confidence in water services is vital, and yet distrust is easier to build up. This is well illustrated by the situation in much of Eastern Europe and in large cities in the Third World. In many of these locations, utilities are not reliable, and water users distrust their utilities: why would they pay gladly for an 'inconstant' service of poor quality water? And yet, the alternative strategies adopted by various user groups to compensate for the unreliability (cisterns, private wells, water vendors) exacerbate the uncertainty for the municipal service. They also tend to aggravate the inequity between the rich and the poor, since the latter will pay more for a little water from vendors than the rich for their luxurious consumption. Maybe it will prove impossible, after all, to upgrade utilities of the South to the standards of European cities; maybe cities need different technologies to provide cheaper services, along with imposing a moral code on water vendors. Looking at it carefully, one could trace a continuum between the kind of poor public service and private alternatives available in large cities of developing countries. Now, if confidence in public water supply in developed countries continues to deteriorate, and if volumes of water sold decline significantly, developed countries, too, may end up with increasingly irregular water supply services.

In that case, what still prevails in large Third World cities would eventually become the rule in developed countries as well: individualistic private solutions increase the social fragmentation of cities and nations.

48 Bakker, K (2003). *From Commons to Commodity? Privatising Water in England and Wales*. Oxford University Press, Oxford.

If this is true, then why are we not looking again to the municipalism of the past, as a solution also for the future? It is suggested here that a way out of the downward spiral of distrust is to involve the municipality, as in the good old days before local welfare and public economy got thrown into the dustbin of history. This type of arrangement may not fully solve the social reverse salient that is threatening public services in developed countries. However, the municipal choice is clearly part of the solution, certainly more so than international financial institutions may think. In particular, while many NGO observers amalgamate the privatisation of the water resource as such with the privatisation of water services — which would result in poor people being starved of freshwater — the real issue is that if local government is weak, there is no institutional mechanism to forge solidarity between social classes through common infrastructure.

Yet, as contemporary European history shows, the main objective of having the municipality manage the water supply was to get the rich to pay for good clean water for the poor, for reasons of controlling epidemics. And this had to be done at city level, which was and still is meaningful. ‘Good governance’ and ‘public private partnerships’ must not forget that.

5.11 Way Forward

The Water UK⁴⁹ categorically states that there is broad consensus about the challenges facing the water sector that include: pollution of water courses; managing surface water, flooding and coastal erosion; managing water resources to provide an affordable public supply; reducing greenhouse gas emissions; and adapting the service to climate change.

These challenges are relatively well defined and understood, as is the context in which they must be addressed. There is broad consensus on the challenges the industry faces and the long term goals it must aim for. By 2030, at the latest, there should be:

- Improved quality for the water environment and ecology that supports it, and continued high drinking water quality;
- Sustainable management of risks from flooding and coastal erosion, with greater understanding and more effective management of surface water;
- Sustainable use of water resources and fair, affordable and cost reflective charges;

⁴⁹ Water UK (2010). Meeting future Challenges. A Blueprint for Policy Action. June 2010.

- Reduced greenhouse gas emissions; and
- Continuous adaptation to climate change and other resources across the water industry and water customers.

The customer agenda is similar, albeit with a slightly different order and emphasis. In summary, customers are willing to support the wider environmental and sustainability agenda provided the basics of the service are transparently and reliably delivered at a price that is affordable. More specifically customers want⁵⁰:

- high quality, reliable services, delivered without restriction or interruption;
- problems fixed quickly, efficiently and first time;
- high quality, responsible and proactive customer services; and

Services delivered in a sustainable way, specifically by: reducing the industry's carbon footprint; improving environmental standards; and maintaining assets for future generations.

For the way forward, Water UK⁵¹ recommended that in order to deliver what customers and wider stakeholders want companies, regulators and government should focus on four activities:

- a) Putting customers first;
- b) Renewing incentives for efficient and sustainable delivery;
- c) Developing flexible regulation that encourages sustainable and innovative behaviour; and
- d) Ensuring sustainable access to the capital markets.

These priorities are aimed at incentivizing the industry to meet successfully the challenges it faces, taking both customers and investors with it.

The Water UK⁵² proposes that it may be possible to empower customers by allowing the final package of services and price to be negotiated directly with a consumer representative within broader parameters agreed with the economic regulator. The process may give additional legitimacy to the consumer voice and in doing so; improve willingness to pay for the broader sustainability agenda.

For any of this to be successful the consumer body must be strong, representative, knowledgeable and probably local⁵³.

50 Water UK (2010). Meeting future Challenges. A Blueprint for Policy Action. June 2010.

51 Water UK (2010). Meeting Future Challenges. A Blueprint for Policy Action. June 2010.

52 Water UK (2010). Meeting Future Challenges. A Blueprint for Policy Action. June 2010.

53 Water UK (2010). Meeting Future Challenges. A Blueprint for Policy Action. June 2010.

Suggested alternatives include consumer panels drawn from local authorities, consumers themselves or a combination of both. In any event, for the change to be successful the consumer body must be given both the power and the ability to represent customers effectively.

Water insecurities are not something new; throughout the history of humankind there has been water scarcities and shortages. But if there is a continuation of the current suggestions of how to solve this, most people will probably never get access to safe, sufficient and secure drinking water and sanitation. As mentioned previously, there are major disagreements about the approaches and policies needed for water and sanitation supply and management. There are two main approaches, namely a market-based approach and a rights-based approach to water. The distinction between these two approaches is based on their position on who owns water and who should therefore be responsible for water supply and sanitation.

5.11.1 A market-based approach

This approach favors the commodification and privatisation of water and is also described as a neo-liberal approach to solving water issues. It is supported by the World Bank, the Global Water Partnership (initiated by World Bank), the World Water Council (a forum of major water corporations), the World Commission on Water, Business Partners for Development (an industry promoter of privatisation) and water TNCs. They argue that water is an economic and tradable good that should be paid for based on market principles. They justify the shift towards a demand-driven approach based on the so-called failure of the supply-driven approach and the inefficiency of public sector providers. The involvement of the private sector is seen as providing this efficiency and necessary for the growing need for investment in water and sanitation. Providing water for free is thus inefficient and uneconomic. The argument is that not recognizing the economic value of water has led to wasteful and environmentally damaging uses of water. The assumption is that if water is priced, it will be valued more; increasing the price of water will lead to more water conservation. This approach is based on the ecological, temporal and human dimensions of water scarcity, but it ignores the socially-constructed or political dimension of water scarcity⁵⁴.

This approach should be understood in the light of corporatist globalization, which promotes corporate rule, deregulation, privatisation and free trade as the

54 Rooyen, C. Water as a Factor in Socio-Economic Development: Future Trends. Department of Anthropology and Development Studies, RAU, South Africa. <http://www.unl.org/unldoc/EOLSS/E2-25-03-03-TXT.aspx>.

solution for nearly every problem people face. In this context everything is up for sale; some argue that even fresh air will be for sale in the near future. Free trade treaties like the General Agreement on Trade in Services (GATS) of the World Trade Organisation (WTO) and the North American Free Trade Agreement have made it possible for TNCs to claim rights over water, since GATS restricts the sovereignty of states in issues of trade in services. It means that the rights of investors are protected. An example is Sun Belt (USA Company) that, under NAFTA, is suing the Canadian government for \$220 million for lost profits, for allowing the banning of water exports in British Columbia, and thus infringing on their investor rights. In South Africa there is currently a court case between Nkonkobe (the former Fort Beaufort municipality) and Water and Sanitation South Africa (WSSA), a subsidiary of Suez Lyonnaise, in which Nkonkobe is contesting the water contract with WSSA based (amongst other things) upon the financial unsustainability of the contract. WSSA has refused to declare the contract invalid⁵⁵.

The private sector has always been involved in water, either as consumers or as informal providers of water or as contractors in water projects or as suppliers of materials, etc. So the issue is not their involvement in water supply and sanitation but the extent of their involvement.

In addition to the privatisation of water services, the tendency is towards the commodification and privatisation of also other water issues like waste management, water transportation, hydropower and bottled-water. Some, for example, see the mass transportation of water as a solution to bring water to where there are water shortages – the private sector are seen as the key role-player to take this challenge up. An example is the US Global Water Corporation that has signed an agreement with Sitka, Alaska, to export 81830m³ of glacier water per year to China. This is not because there is a water shortage in China, but because they want to bottle the water in China, using China's cheap labor. This bottled water industry that the global bottled water market was valued at USD157 billion in 2013, and expected to reach USD279 billion by 2020. The text now says it is only 2.2 billion⁵⁶.

One should expect a continuation of the increased role for the private sector in the provision of water, especially in urban areas. The eagerness of TNCs to enter this market is obvious: in the USA water market, which is still mainly in public hands⁵⁷.

55 Rooyen, C. Water as a Factor in Socio-Economic Development: Future Trends. Department of Anthropology and Development Studies, RAU, South Africa. <http://www.unl.org/unldoc/EOLSS/E2-25-03-03-TXT.aspx>.

56 Rooyen, C. Water as a Factor in Socio-Economic Development: Future Trends. Department of Anthropology and Development Studies, RAU, South Africa. <http://www.unl.org/unldoc/EOLSS/E2-25-03-03-TXT.aspx>.

57 Rooyen, C. Water as a Factor in Socio-Economic Development: Future Trends. Department of Anthropology and Development Studies, RAU, South Africa. <http://www.unl.org/unldoc/EOLSS/E2-25-03-03-TXT.aspx>.

These so-called public-private partnerships (PPPs) or public sector participation means that the private sector and market forces are relied upon to solve the water challenges. PPPs are co-operation agreements between the public and private sector to plan, finance, construct and operate water services. PPPs are also part of the process of privatisation of water. Various types of privatisation contracts exist⁵⁸.

Although there is much talk of the privatisation of water, it is mainly the United Kingdom and France, of the developed countries, that strongly follow such privatisation. North America follows a public sector model, as in the majority of the rest of the world. But the Structural Adjustment Programs of the IMF and World Bank are pushing developing countries into water commodification and privatisation. Any type of privatisation requires that the public sector must fulfill a strong regulatory function, but this is exactly the opposite of what the private sector advocates⁵⁹.

Opponents of the market-based approach to water include the Global Water Contract, the P-7 Declaration on Water, the Blue Planet Project in Canada and the Cochabamba Declaration (based on the struggle against water privatisation in Bolivia). Their arguments against the commodification and privatisation of water include⁶⁰:

- The global water market is dominated by very few TNCs, especially French TNCs. The three big ones are Vivendi, Suez Lyonnaise des Eaux and SAUR/Bouygues; together they have 70 per cent of the global water market. There are often secret agreements between them in vying for contracts. This means that no competition and free market exist, but rather a monopoly. In Côte d'Ivoire for example, SAUR got the concession for the entire country in 1987 without any competitive tender. This can easily lead to inflated charges. In monopolies, unless government regulation is strict, public interests will be discarded.
- The assumption that the private sector is more efficient and less corrupt than public sector is a false one. The tendency is to use efficiency, flexibility and innovation synonymous with the private sector, while associating inefficiency, bureaucracy and lethargy with the public sector. But corruption, favoritism and bribery are just as widespread in the private sector as in the public sector. The awarding of contracts is especially open to corruption. For example, two French water TNCs

58 Rooyen, C. Water as a Factor in Socio-Economic Development: Future Trends. Department of Anthropology and Development Studies, RAU, South Africa. <http://www.unl.org/unldoc/EOLSS/E2-25-03-03-TXT.aspx>.

59 Rooyen, C. Water as a Factor in Socio-Economic Development: Future Trends. Department of Anthropology and Development Studies, RAU, South Africa. <http://www.unl.org/unldoc/EOLSS/E2-25-03-03-TXT.aspx>.

60 Rooyen, C. Water as a Factor in Socio-Economic Development: Future Trends. Department of Anthropology and Development Studies, RAU, South Africa. <http://www.unl.org/unldoc/EOLSS/E2-25-03-03-TXT.aspx>.

have been convicted of paying bribes to be awarded contracts in France. The fact that TNCs usually insist on contracts remaining secret, undermines democracy, transparency and accountability. The example of the contract between WSSA and Nkonkobe in South Africa can be mentioned in this regard. The contract states that any detail of the contract cannot be disclosed to any third party without the written approval of WSSA. Furthermore, the long-term nature of many of the water contracts makes it is nearly impossible for the state to get out if a private provider is inefficient and unaffordable.

- The principle of full cost-recovery, or use pay, adapted by the market-based approach, is based on the idea of economic efficiency. It means that consumers must pay the O&M and capital costs of water systems. This leads to decisions about water, especially its allocation, being based on commercial interests and profits, and not humanitarian and moral reasons. Urban areas are then focused on, to the detriment of rural poor. A cost-recovery policy demands that government subsidies must be done away with. It is interesting to note is that although the USA subsidizes water, there is no pressure on them do away with this, as in the case of developing countries being forced by the IMF/World Bank to privatise.
- In the light of development needs, the worst impact of the commodification and privatisation of water is that commercial interests override development and equity objectives. The reality of cost-recovery is that water is delivered to those who can pay for it. This means that because the poor cannot pay, water networks are not extended to them. The poor then end up paying more for water than the rich, who have existing water infrastructure. But it is the rich who consume more water, and should thus pay more, if the logic of the economic value of water is followed. Cost-recovery also gives justification for water cut-offs based on outstanding bills. In the United Kingdom (UK), after water privatisation in 1992 over 21 000 customers were disconnected, an increase of 200 per cent on the previous year. For many reconnection fees are also unaffordable. Such actions then rather play in the hands of growing inequalities. Although neo-liberal thinkers assume that a market-based approach and issues of equity are compatible, the market does not ensure equitable distribution of water.
- Price hikes are also a common occurrence after privatisation. An example is Cochabamba in Bolivia where consumers protested violently against average price increases of 35 per cent, after a 40-year concession was given to Aguas-del-Tunari in 1999. In Buenos Aires customers paid 20 per cent more for water after privatisation and in France it was 13 per cent more. This makes water even less affordable for the poor and further increases inequalities. Increases in water prices also mean that households have to cut spending on health and education, to be able to afford

water. The problem with a market-based approach is that it sees pricing as mainly a financial instrument to ensure efficiency. But pricing is also an instrument that should serve social and environmental objectives.

- Price increases do not necessarily correlate with better service and improved water quality. In wanting to maximize profits, companies reduce expenditure, which can negatively affect maintenance and quality of water. In fact in France the government found that “bacterially unacceptable” water was provided for some 5.2 million people in the 1990s, after water privatisation and higher prices. In the UK the amount of water leakages has also increased by 30 per cent since privatisation. Environmental damages of water privatisation include water pollution. Vivendi, for example, was found guilty in France in 1994 of supplying unsafe water, with excessive nitrates and pesticides, to people. Between 1995 and 2000 the Puerto Rico Aqueducts and Sewers Authority (PRASA), privatized in 1995 to *Compañía de Aguas*, a subsidiary of Vivendi, has been fined \$6,2 million for violations of US environmental laws. Excessive withdrawals of water to ensure more profits do occur. Some contracts have so-called take-or-pay elements that oblige governments to buy bulk water irrespective of the water demand. Consumption is thus encouraged regardless of whether the need for such consumption exists. In this regard, a subsidiary of Suez Lyonnaise was convicted in 1998 of illegal over-abstraction of water in Suffolk over a three-year period.
- Most discussions around water pricing focus on domestic water use, yet this is where the least amount of water is consumed. Irrigated agriculture is the biggest consumer of water – 70 per cent of global water use – yet they pay the least and experience very little regulation around water use. This creates suspicion about the arguments for the economic value of water driving water pricing.
- Support for a market-based approach comes from studies that indicate the willingness of people to pay for water supply. Such studies estimated that households are willing to pay around ten per cent of their expenditure. But willingness to pay gives no indication of the ability to pay. Because water is needed to live, all will be willing to pay for it. The issue should be whether they can afford it.
- In the light of the huge need for basic water by millions, the excessive increases in corporate profits and shareholder returns after privatisation are inexcusable. Some privatisation contracts even guarantee profits. This means that losses by the private operator are transferred to the consumers or taxpayers. Such profit guarantees can easily lead to increased debt by governments. The private sector operators often receive financial support from the public sector like non-refundable grants for operation or tax holidays. Another aspect of the development impact of private sector providers, especially the TNCs, is that they usually are multi-utilities also

involved in sectors other than water (the UK water companies are the only ones that specialize in water services). Profits made from water are then used elsewhere in the operations of the TNC. Such “milking the cow” means that a basic human necessity is exploited for profit and greed.

- Many TNCs also do not have good labor track records. Lay-offs, disparity between domestic and foreign employees, exorbitant executive remuneration and discrimination against union members are some of the criticisms being mentioned. Job lay-offs and retrenchments occur in spite of improved profits for companies. It is argued that this is needed to ensure efficiency, but fewer staff does not automatically mean more efficiency. Suez Lyonnaise, for example, in its operations in India, has different pay scales for local and foreign employees. And nothing can justify the high salary packages given to executives of water TNCs while millions of poor people cannot afford water.

With these criticisms of the commodification and privatisation in mind, many argue that inefficient public sector water services should not necessarily mean that the private sector should take over this responsibility. It might simply mean that reform and restructuring of the public sector is needed. This can happen through public sector water undertakings (PWUs), public-public partnerships (PUPs) and corporatization (when a public utility forms a commercial enterprise that remains in public ownership). In the developed countries such public sector responsibility is the norm for water and sanitation services; the UK and France with their privatisation models are the exceptions. PUPs are partnerships between public sectors which can involve capacity building and training, financial assistance and expertise provided by other public sector organizations that have experience in that field. Local PUPs are between public sectors within the same country, while international PUPs are between public sectors from different countries. An example of a local PUP is that of the local government authority in Odi, South Africa, and Rand Water, a parastatal providing bulk water, for the development of water services in Odi over a three year-period. PWUs and PUPs are not less efficient than the private sector undertakings, and they do consider public interest, especially that of the poor and development objectives⁶¹.

In spite of criticisms against the commodification and privatisation of water, it is set to continue and increase in the future. The reality is that markets operate in a framework of economic, social, cultural and political power. By viewing water as

61 Rooyen, C. Water as a Factor in Socio-Economic Development: Future Trends. Department of Anthropology and Development Studies, RAU, South Africa. <http://www.undl.org/unldoc/EOLSS/E2-25-03-03-TXT.aspx>.

only an economic good, the multifaceted aspects of water, like its cultural and social value, are ignored. A right-based approach to water claim not to do that.

5.11.2 A rights-based approach to water

In addition to water being a basic human need (for drinking, cooking, hygiene and food production), access to water is also a fundamental human right. This means that governments have a duty to protect and promote this right. Although only the 1989 Convention on the Rights of the Child explicitly states in article 24 water as a human right, the other major human rights conventions make water implicitly part of, for example, the right of food, health and life. (The Bill of Rights of the South African Constitution also explicitly states the right of access to sufficient water.) According to a rights-based approach to water scarcity and shortages, the human right to water should take precedence over any other consideration in water management. The Global Water Contract, Vision 21, the Water Manifesto, many NGOs and civil society organizations argue for water to be viewed as a human right and a common global heritage⁶².

This approach argues that a new water ethic is needed. Firstly, for humanitarian reasons and for justice and equality, water must be treated as a human right. This also implies that central in water issues should be public interests and not profits. Public interests include social justice and equity (that includes gender equity), public health and the environment. Therefore this approach is both equitable and efficient⁶³.

Secondly, the state has an important role to play in ensuring that access to water and sanitation are realized. The social contract between people and government implies that governments have the responsibility and obligation to ensure this right to water, and not simply aspire to do so. Government should guarantee water services to the poor and regulate strongly any private sector involvement in water services. Although the private sector can be involved in water services, it should supplement, and not substitute, the public sector⁶⁴.

Because water is a human right, it is thirdly the state's obligation to ensure minimum water consumption for free. Such lifeline water services should be determined

62 Rooyen, C. Water as a Factor in Socio-Economic Development: Future Trends. Department of Anthropology and Development Studies, RAU, South Africa. <http://www.unl.org/unldoc/EOLSS/E2-25-03-03-TXT.aspx>.

63 Rooyen, C. Water as a Factor in Socio-Economic Development: Future Trends. Department of Anthropology and Development Studies, RAU, South Africa. <http://www.unl.org/unldoc/EOLSS/E2-25-03-03-TXT.aspx>.

64 Rooyen, C. Water as a Factor in Socio-Economic Development: Future Trends. Department of Anthropology and Development Studies, RAU, South Africa. <http://www.unl.org/unldoc/EOLSS/E2-25-03-03-TXT.aspx>.

in specific national contexts, although a general guideline for reasonable access is the availability of between 20-50 liters per person per day from a source within one kilometre from the user's dwelling. The South African government has adopted a policy for free basic water of 25 liters of safe water per person per day within 200m of their home. With rights go responsibilities; this means that free water provision should not mean that water can be used at free will. The right to water implies the duty to maintain water resources⁶⁵.

Stepped or block tariffs can then be used to discourage overconsumption of water. This simply means that lifeline water services are provided free of charge, but as consumption increases from that point upward, tariffs also increase steeply. Cross-subsidization can then be used to cover the cost of the free water lifeline. There are also arguments for the universality of water services rather than an indigence policy that give "special" status to certain groups of consumers. Such special status is usually based on residential area, value of property or class. This can lead to stereotypes and justifications for providing water to the "deserving", while not for the "undeserving"⁶⁶.

Fourthly, because each specific context, in which water is used, influences the rights to access of different people and how water is managed, water should be managed at a local level. (And not by international companies that know very little of the specific local context.) All stakeholders at this level – governments, civil society, NGOs, the private sector, etc. – must work together in partnerships to ensure water security and sustainable development for all. At a local level water use associations, watershed committees and co-operatives have been very successful in doing this. Co-operation and co-ordination between states that share a water resource, is also priority⁶⁷.

From a rights-based approach it should be clear that the key challenge in water services is not financial in nature, but rather political.

65 Rooyen, C. Water as a Factor in Socio-Economic Development: Future Trends. Department of Anthropology and Development Studies, RAU, South Africa. <http://www.unl.org/unldoc/EOLSS/E2-25-03-03-TXT.aspx>.

66 Rooyen, C. Water as a Factor in Socio-Economic Development: Future Trends. Department of Anthropology and Development Studies, RAU, South Africa. <http://www.unl.org/unldoc/EOLSS/E2-25-03-03-TXT.aspx>.

67 Rooyen, C. Water as a Factor in Socio-Economic Development: Future Trends. Department of Anthropology and Development Studies, RAU, South Africa. <http://www.unl.org/unldoc/EOLSS/E2-25-03-03-TXT.aspx>.

CHAPTER SIX

6.0 CONCLUSION

Water is needed for human survival and life. Development of all people also depends on water. Greater access to safe water and sanitation (especially in poor countries) and the sustainable use of water should be ensured. This requires that all must redefine their use of water, their values and their lifestyles, so as to live sustainable lives

To ensure this, the roles of both the public and private sector in water services have been debated. In the light of millions of people lacking the most basic sustenance for life, water, selling water for profit is, to say the least, bizarre. Water should primarily support life, not provide profits for companies. Furthermore, development considerations have to receive priority above profit considerations, when decisions about water are made. The social and economic benefits of providing basic water to all far outweigh any costs of providing it. The question is really if the private sector has the will to deliver water to the poor. Their proposed solution to the lack of access to water, namely to raise the price of water, will only further worsen access to water. The water wars of the future might then not be between countries/communities sharing water resources, but probably rather between water TNCs and people. The reality is that provision of water is driven by political economy rather than by free market forces. The state should therefore be actively involved in ensuring the right to water of all¹.

Dublin+10 in Bonn in 2002, Rio+10 in September 2002 in Johannesburg and the Third World Water Forum in 2003 provide opportunities to all to address the challenges faced with water and development. The General Assembly of the UN also

1 Rooyen, C. Water as a Factor in Socio-Economic Development: Future Trends. Department of Anthropology and Development Studies, RAU, South Africa. <http://www.unl.org/unldoc/EOLSS/E2-25-03-03-TXT.aspx>.

declared 2003 as the International Year of Fresh Water. In all these, and many other places, the following principles should underline the use and protection of water².

Access to adequate clean water is a basic human right. This implies that government must ensure the right to water.

- Intra- and inter-generational equity must be ensured through the sustainable use of water by all.
- The links between water access and use, and power relations should be acknowledged clearly.
- Participation by water users, especially women is needed. This requires the decentralization of water management to local levels. All stakeholders, government, civil society, NGOs, the private sector, etc., should participate.
- Holistic, integrated water management is needed to ensure sustainability.
- The commodification and privatisation of water are not sustainable.
- Viable alternatives to privatisation, like PUPs, PWUs, co-operatives, etc., should be found.

Everyone has the right to water to sustain their life and their livelihoods. And to echo the New Delhi Declaration in 1990, sustainable development requires “some for all rather than more for some”.

A great deal has been learned from the development and management of water through the historical trends and hence, the way in which the immediate and future management challenges would be met must reflect this.

It is essential that into the future, the balanced bottom-line value from water is optimized water access entitlements are needed that match the acceptable water yield, as well as triggers mechanisms that foresee and enable adjustment to occur. The potential to apply the lessons of history provides confidence that adjustments can be made for a more sustainable future.

National level: There is an immediate need for the ministry of water and irrigation to strengthen its capacities focused on water investments in support of infrastructure for water conservation and management. Good water governance should be viewed as part of a set of sustainable development strategies to alleviate poverty and advance human security. Such strategies should include conducting vulnerability assessments, providing access to information, building human and institutional capacity, and pro-

2 Rooyen, C. Water as a Factor in Socio-Economic Development: Future Trends. Department of Anthropology and Development Studies, RAU, South Africa. <http://www.undl.org/unldoc/EOLSS/E2-25-03-03-TXT.aspx>.

moting public and private investments in the country. Finance is a critical element of any strategy to address water security. To achieve these goals, greater coordination among government ministries such as the ministries of finance, regional development, local authorities, health, environment and natural resources, and education will be required.

Water in security policy planning: Ministry of water and irrigation should ensure that water management institutions have developed integrated water management and conflict prevention capacities where needed. By the same token, policy-setting discussions on water sustainability should be expanded to include traditional security actors. As a preventive measure, conflict resolution mechanisms to address intra-water issues between communities should be developed or strengthened.

Raising the awareness: The World Economic Forum³ indicates that while water and environment experts and communities have been aware of the extent of the water issue for many years, the message that water is a key strategic issue needs to be much more widely broadcast in the business and political domains, in order to motivate and catalyse action. Water needs to be put on the boardroom agenda and shifted more firmly into political and economic decision-making. Special, but not exclusive attention, should be given to water use in agriculture, particularly in a perspective of looking for the best cost-benefit relationship in our actions to conserve water.

Investment and collaboration: Emphasis should be placed on spurring greater investment in the infrastructure and knowledge systems needed to manage complex water systems for the benefit of all. To fill the water investment gap, both public funding and private financing will be required.

Policy dialogue: There are many ministries whose policies in one way or the other have a direct bearing to the water policy. The importance of dialogue among the range of other ministries whose policies have a direct or indirect bearing to the water policy cannot be overstated. Policy makers at every level, as well as nongovernmental organizations, civil society groups, and private enterprises, must be stakeholders in the responsible management of water resources. Public and private-sector partnerships should be strengthened to ensure broad and equitable ownership of water resources. Nongovernmental organizations, civil society groups, scientists, and researchers are often at the front line of improving water access at the local level and should be con-

3 World Economic Forum (2008). *Managing our Future Water Needs for Agriculture, Industry, Human Health and the Environment*. Discussion Document for the World Economic Forum Annual Meeting 2008.

sulted on water related policy-setting processes. Drawing on local knowledge should be a priority. Women and poor communities should be given greater input into the management of water resources. The experiences and expertise of local leaders across sectors and societal spheres from WSBs, provinces, communities, grassroots organizations, and businesses who are advancing sustainable water management practices and models of mediation and conflict resolution to address water-related disputes should be collected and disseminated, with a view toward extrapolating best practices for broader application.

To identify sustainable solutions to existing and emerging water problems, the Ministry of water and irrigation needs to support a series of multistakeholder policy dialogues with various public institutions playing a central role on matter related in any form to water use. The dialogues will focus on water governance, on incentives for more efficient water use overall, on market-based instruments and on how water is being allocated (and re-allocated). Multistakeholder groups and public-private partnerships that include governments, businesses and a wide range of other actors are required to find and implement home grown solutions.

Working together, we can deliver more, for customers, the environment, the economy and the whole of society.

Climate change: A long-term view of changes in the water regime resulting from climate change would help to advance cohesive strategies and policy directions for managing risks that are likely to develop in the future.

Water challenges are linked to the climate change issue, but it is not only about climate change. The main cause of water shortage is overuse, and water quality is also important.

Data quality: Data available clearly demonstrates unreliability of water resource data. The variation in officially reported figures on water and sanitation coverage, water quantity and quality throughout the country clearly illustrates this picture. The lack of accurate data is an impediment to effective policy making. The production of high-quality data needs to be a priority across the country. To address these shortcomings, WSBs with their agents should embark on data-collection capacity to gather quality water data countrywide. Such an effort needs to be expanded with greater institutional support.

CHAPTER SEVEN

7.0 APPENDICES

The Development of International Water Policies Table 7.1 demonstrates the development of international water policies particularly with impact to the Kenya water supply development¹.

Table 7.1: Development of international water polices

Dates	Events	Outcomes	Quotations
1972	UN Conference on the Human Environment, Stockholm Main issues; preservation and enhancement of the human environment	Declaration of the UN Conference on the Human Environment	'A point has been reached in history when we must shape our actions throughout the world with a more prudent care for the environmental consequences.' (6. Declaration of the UN Conference on the Human Environment)
1977	UN Conference on Water, Mar del Plata	Mar del Plata Action Plan	'Relatively little importance has been attached to water resources systematic measurement. The processing and compilation of data have also been seriously neglected.' (Recommendation A: Assessment of water resources, Mar del Plata Action Plan).

¹ WSSCC (2000). United Nations World For People; Water for People, water for Life: Water De.

Dates	Events	Outcomes	Quotations
1981-1990	International Drinking Water and Sanitation Decade		'The goal of the Decade was that, by the end of 1990, all people should possess and adequate water supply and satisfactory means of excrete and silage disposal. This was indeed an ambitious target as it has been estimated that it would have involved the provision of water and sanitation services to over 650,000 people per day for the entire ten year period. Although major efforts were made by government and international organisations to meet this target, it was not achieved.' (Choguill, C; Francys, R.; Cotton, A 1993. Planning for Water and Sanitation).
1990	Global Consultation on Safe Water and Sanitation for the 1990s, New Delhi. Main issues: safe drinking water, environmental sanitation.	New Delhi Statement: 'Some for all rather than more for some	'Safe water and proper means of waste disposalmust be at the centre of integrated water resources management' (Environment and Health, New Selhi Statement)
	World Summit for Children, New York Main issues: health, food supply	World Declaration on the Survival, Protection and Development of Children	'We will promote the provision of clean water in all communities for all their children, as well as universal access to sanitation.' (18. World Declaration on the survival, Protection and Development of Children)
	Beginning of the International Decade for Natural Disaster Reduction (1990 – 2000)	Recognition of the increased general vulnerability of people and property to natural disasters	'to reduce through concerted international action especially in developing countries, the loss of life, property damage and social and economic disruption caused by natural disasters.....' (Resolution 44/236 of the UN General Assembly)
1992	International Conference on Water and the Environment, Dublin. Main issues: economic value of water, women, poverty, resolving conflicts, natural disasters, awareness	Dublin Statement on Water Sustainable Development	Principle1: 'Fresh water is a finite and vulnerable resource, essential to sustain life, development and the environment' Principle 2: 'Water development and management should be based on a participatory approach, involving users, planners and policy-makers at all levels', Principle 3: 'Women play a central part in the provision, management and safeguarding of water' Principle 4: 'Water has an economic value in all its competing uses and should be recognized as an economic good' (Guiding principles. The Dublin Statement on Water and Sustainable Development).

Dates	Events	Outcomes	Quotations
	Un Conference on Environment and Development (UNCED Earth Summit), Rio de Janeiro Main issue: cooperation and participation, water economics, drinking water and sanitation, human settlement, sustainable development, food production, climate change.	Rio Declaration on Environment and Development Agenda 21	'establishing a new and equitable global partnership through the creation of new levels of cooperation among States, key sector societies and people' (Rio Declaration) 'The holistic management of freshwater ... and the integration of sectoral water plans and programmes within the framework of national economic and social policy are of paramount importance for action in the 1990s and beyond.' (Section 2, chapter 18, Agenda 21)
1994	Ministerial Conference on Drinking Water Supply and Environmental Sanitation, Noordwijk Main issues: drinking water supply and sanitation.	Programme of Action	'To assign high priority to programmes designed to provide basic sanitation and excreta disposal systems to urban and rural areas.' (Action Programme)
	UN International Conference on Population and Development, Cairo	Programme of Action	'To ensure that population, environmental and poverty eradication factors are integrated in sustainable development policies, plans and programmes.' (Chapter III – Interrelationships between population, sustained economic growth and sustainable development, C – Population and Environment, Programme of Action).
1995	World Summit for Social Development, Copenhagen Main issues: poverty, water supply and sanitation	Copenhagen Declaration on Social Development	'To focus our efforts and policies to address the root causes of poverty and to provide for the basic needs of all. These efforts should include the provision of ... safe drinking water and sanitation.' (Chapter 1 – Resolution adopted by the Summit, Commitment 2.b., Copenhagen Declaration).
	UN Fourth World Conference on Women, Beijing Main issues: gender issues, water supply and sanitation	Beijing Declaration and Platform for Action	"Ensure the availability of and universal access to safe drinking water and sanitation and put in place effective public distribution systems as soon as possible.' (106 x, Beijing Declaration)
1996	UN Conference on Human Settlements (habitat II), Istanbul Sustainable human settlement development in an urbanizing world	The Habitat Agenda	'We shall also promote healthy living environments especially through the provision of adequate quantities of safe water and effective management of waste.' (10. The Habitat Agenda, Istanbul Declaration on Human Settlement)

Dates	Events	Outcomes	Quotations
	World Food Summit, Rome Main issues: food, health, water and sanitation	Rome Declaration on World Food Security	'To combat environmental threats to food security in particular, drought and desertification ... restore and rehabilitate the natural resource base, including water and watersheds, in depleted and overexploited areas to achieve greater production. (Plan of Action Objective 3.2, Rome Declaration).
1997	First World Water Forum, Marrakech Main issues: water and sanitation, management of shared waters, preserving ecosystems, gender equity, efficient use of water	Marrakech Declaration	'to recognize the basic human needs to have access to clean water and sanitation, to establish an effective mechanism for management of shared waters, to support and preserve ecosystems, to encourage the efficient use of water.' (Marrakech Declaration)
1998	International Conference on Water and Sustainable Development, Paris	Paris Declaration on Water and Sustainable Development	'to improve co-ordination between UN Agencies and Programmes and other international Organisations, to ensure periodic consideration within the UN system ... (to) emphasize the need for continuous political commitment and broad-based public support to ensure the achievement of sustainable development, management and protection and equitable use of freshwater resources, and the importance of civil society to support this commitment.' (Paris Declaration).
2000	Second World Water Forum, The Hague Main issues: water for people, water for food, water and nature, water in rivers, sovereignty, inter-basin transfer, water education	World Water Vision: Making Water Everybody's Business	'Involve all stakeholders in integrated management; move to full-cost pricing of water services; increase public funding for research and innovation; Increase cooperation in international water basins; Massively increase investment in water' (Vision Statement and Key Messages, World Water Vision).
	7 challenges: Meeting basic needs, securing the food supply, Protecting ecosystems, sharing water resources, Managing risks, Valuing water, Governing water wisely	Ministerial Conference on Water security in the 21 st Century	'We will continue to support the UN system to re-assess periodically the state of freshwater resources and related ecosystems, to assist countries where appropriate, to develop systems to measure progress towards the realisation of targets and to report in the biennial World Water Development Report as part of the overall monitoring of Agenda 21.' (7.B Ministerial Declaration).

Dates	Events	Outcomes	Quotations
		UN Millennium Declaration	'We resolve ... to halve, by the year 2015 ... the proportion of people who are unable to reach or to afford safe drinking water.' (19, UN Millennium Declaration)
2001	International Conference on Freshwater, Bonn Water – Key to sustainable development Main Issues: Governance, Mobilizing financial resources, Capacity-building, and sharing knowledge	Ministerial Declaration Recommendations for action	'Combating poverty is the main challenge for achieving equitable and sustainable development, and water plays a vital role in relation to human health, livelihood, economic growth as well as sustaining ecosystems.' (Ministerial Declaration) 'The conference recommends priority actions under the following three headings: Governance Mobilizing financial resources Capacity building and sharing knowledge' (Bonn Recommendations for Action)
2002	World Summit on Sustainable Development, Rio+10, Johannesburg	Johannesburg Declaration on Sustainable Development	'We recognise the poverty eradication, changing consumption and production patterns, and protecting and managing the natural resources base for economic and social development are overarching objectives of, and essential requirements for sustainable development.' (Para.11 Declaration of Sustainable Development).
		Plan of Implementation	'The provision of clean drinking water and adequate sanitation is necessary to protect human health and the environment. In this respect, we agree to halve, by the year 2015, the proportion of people who are unable to reach or to afford safe drinking water (as outlined in the Millennium Declaration) and the proportion of people who do not have access to basic sanitation ...' (11.7, Plan of Implementation). 'Develop integrated water resources management and water efficiency plans by 2005, with support to developing countries, through actions at all levels to: Develop and implement national/regional strategies, plans and programmes with regard to integrated river basin management, Employ the full range of policy instruments, including regulation, monitoring, voluntary measures, market and information-based tools. Improve the efficient use of water resources.' (IV.24, Plan of implementation).

Dates	Events	Outcomes	Quotations
2003	International Year of Freshwater		<p>'Water is likely to become a growing source of tension and fierce competition between nations, if present trends continue, but it can also be a catalyst for co-operation. The International Year of Freshwater can play a vital role in generating the action needed – not only by governments but also by civil society, communities, the business sector and individuals all over the world.' (UN Secretary-General, Kofi Annan)</p>