

# We are IntechOpen, the world's leading publisher of Open Access books Built by scientists, for scientists

5,300

Open access books available

130,000

International authors and editors

155M

Downloads

Our authors are among the

154

Countries delivered to

TOP 1%

most cited scientists

12.2%

Contributors from top 500 universities



WEB OF SCIENCE™

Selection of our books indexed in the Book Citation Index  
in Web of Science™ Core Collection (BKCI)

Interested in publishing with us?  
Contact [book.department@intechopen.com](mailto:book.department@intechopen.com)

Numbers displayed above are based on latest data collected.  
For more information visit [www.intechopen.com](http://www.intechopen.com)



## Evaluation of QoS and QoE in Mobile WiMAX – Systematic Approach

Adam Flizikowski<sup>1</sup>, Marcin Przybyszewski<sup>2</sup>,  
Mateusz Majewski<sup>2</sup> and Witold Hołubowicz<sup>3</sup>

<sup>1</sup>University of Technology and Life Sciences, Bydgoszcz,

<sup>2</sup>ITTI Ltd., Poznań,

<sup>3</sup>University of Adam Mickiewicz, Poznań,  
Poland

### 1. Introduction

International standardization organizations, responsible for preparing specifications (such as IMT-Advanced) for emerging 4G networks, define requirements for system level simulations for the candidate technologies [1], [2]. The goal behind those documents is to facilitate System-Level-Simulations by providing common methodology to perform such simulations (i.e. for WiMAX). According to [1] cell-level simulations can be an intermediate step between Link and System-level simulation where the capacity of a single cell and a single Base Station, providing service for multiple users, is evaluated by means of comprehensive tests. Still the IEEE standardized simulation methodology [1] does not specify how to evaluate (WiMAX) system capacity with various connection admission control mechanisms. Therefore as a first step we focus on the problem of adjusting simulation methodology to facilitate simulations covering CAC with Time Division Multiplexing Access scheme (TDMA), OFDM and uplink traffic. The applied evaluation methodology is derived from the best-practices in IEEE 802.16m Evaluation Methodology Document and WiMAX Forum's System-Level-Simulation (SLS) methodology. Afterward the introduced methodology is utilized to find answers to the following problems:

- To what extent does the capacity change when different FEC codes are deployed (Convolutional Turbo Coding - CTC, non binary Low-Density Parity-Check - nbLDPC)
- What is the user perception of the service quality (Quality of Experience - QoE) and what are the differences in the system performance when different FEC codes are deployed?
- How to improve resource estimation, especially when considering connection requests arriving in large batches?
- How the performance of traffic - aware admission control algorithms changes, when some users follow VoIP traffic pattern with silence-suppression enabled?
- Does the performance of measurement based CAC change, if the system experiences situations, in which connection requests arrive in large batches?

Since QoS support is an important part of WiMAX network, the system under test (SUT) controls resources using admission control (AC) mechanism. Arrival Rate aided Admission Control (ARAC) and its predecessor EMA - based Admission Control (EMAC) [41] are designed for controlling the VBR traffic. Moreover ARAC can cope with the problem of connections arriving in large batches. EMAC relies on calculating simple exponential weighted moving average (EWMA) of the overall resource consumption. ARAC differentiates between new and ongoing connections thus providing more accurate resource estimations.

To improve the fidelity level of the simulator and introduce mobile channels, method called Link-To-System interface (L2S) has been implemented. This approach removes constraints that arise when AWGN channel is being used. In particular a method based on mutual information (MI) called RBIR (Mutual Information Per Received Bit | Received coded Bit Information Rate) was selected. It is important, since attempting to simulate scenarios close to reality requires combining admission control and user mobility. The mobility model used is based on traces following the Levy-walk distribution. Users' movements have been captured for a given geographical area and combined with maps generated by the Radio Mobile radio coverage planning tool [4]. Thus we are able to present results of assessing quality of VoIP (Voice Over IP) conversations also in the case of novel non-binary Low Density Parity-Check (nb-LPDC) coded WiMAX networks. The corresponding work is described within this chapter.

Finally, using L2S technique allows comparing SUT's performance using either nbLDPC or well-recognised CTC codes. Thus we eventually provide a comparison of CTC and nbLDPC codes in terms of resulting system capacity and quality of experience (QoE) as perceived by VoIP flows - it is shown that DaVINCI codes perform slightly better than CTC in the total cell utilization and decreased dropping probability. The QoE metrics measured show slightly more users are satisfied in a single cell with DaVINCI codes than when CTC is used.

The rest of the chapter is organized as follows: in Section 2 authors describe the related work and provide background information on previous work dealing with CAC and QoE in WiMAX networks. In Section 3 the authors provide information on how to evaluate WiMAX with CAC and compare this methodology with standardized SLS simulation approaches. In Section 4 a description of ns-2 and Matlab integration using Link-To-System (L2S) mapping can be found. Additionally information on simulator configuration is given. In Section 5 authors present the results collected for nbLDPC and CTC codes in QoS-aware WiMAX system. Discussion on QoE results is provided in Section 6. The authors conclude with Section 7.

## 2. Related work

The concept of QoS in broadband wireless networks has evolved during the past decade. More and more resource consuming applications emerge and by the time IPv6 protocol has been fully deployed, QoS capable systems will play an important role in IP-based wireless broadband networks. The importance of how QoS-aware networks can influence future wireless traffic is presented in [7] where authors compare existing QoS framework for WiMAX and LTE. The emphasis is put on the main differences in handling QoS in both 4G systems. Even though the underling technologies differ in many aspects, it is important to

note that future 4G candidate networks are designed to provide services with guaranteed quality. Therefore QoS-aware mechanisms like Connection Admission Control or Packet Scheduling are to be deployed in order to align network capabilities with user needs and expectations when using a service [8].

Admission control algorithms can be classified according to method used to assess current system load. In parameter - based admission control (PBAC or DBAC) information about current state of the system's available resources is based solely on declarations made by applications. Therefore the performance of this kind of admission control is highly dependent on accuracy of the declarations, availability and types (depending on the system) of descriptors. Another approach is to use traffic measurements to estimate the current system load. This technique is used by MBAC (measurement - based admission control) algorithms.

One of the challenges is to estimate the incoming traffic characteristics using only provided descriptors. Especially it can prove hard to estimate required resources in a system utilizing Adaptive Coding and Modulation (ACM). Applications usually express their bandwidth requirements in bits (bytes) per second. In OFDM/ OFDMA systems utilizing ACM each user can use coding and modulation scheme most appropriate to his channel conditions. Therefore even a an application generating constant amount of traffic can require different number of OFDM symbols (/OFDMA slots). Therefore achieved transfer rates of a wireless link can vary significantly over short period of time. This adds a "second dimension" to the problem of estimating resources required by an application, since it is hard to predict how particular channel conditions will vary over time. This is in contrast to classic approach to admission control, where capacity of a link in terms of a maximum throughput / number of calls is considered constant. As a consequence, in such an ACM-enabled system, OFDM symbols (or slots for OFDMA) should be considered a scarce resource, since number of symbols available for a given system remains constant. PBAC algorithms seem more suited for systems where it is easy to properly describe flow characteristics (e.g. CBR traffic is usually easily described) and the required slots / symbols of a given flow do not fluctuate significantly over time (due to e.g. variations channel conditions).

The problem of estimating free resources can be mitigated (to some extent) by focusing on MBAC algorithms coupled with appropriate congestion control algorithms. MBAC algorithms are appropriate for systems where flow characteristics are not easily defined (or available traffic descriptors are not sufficient) and the required slots / symbols of a given flow can fluctuate significantly over time (due to e.g. variations in channel conditions). Although new connections requirements still have to be obtained through declarations, the percentage of bandwidth being used in reality by ongoing connections is known (usually at a base station level) thanks to measurements of traffic. If channel conditions of multiple users have become worse and the system approaches congestion, congestion control algorithm tries to minimize system load. This can be achieved in many ways, e.g. by signalling AC algorithm to block a part (or all) of the new connections requests, changing downlink / uplink scheduling priorities, or even by dropping some of the ongoing connections. Still it needs to be discussed, if e.g. dropping previously accepted connection is an acceptable congestion control policy. Still, few articles exist that are dedicated to this problem in admission control.

Nevertheless CAC in cellular networks has been a hot research topic for a few past years, since users' demand for mobile applications is constantly rising. A technique called Complete Sharing (CS) assumes that all connections are accepted as long as the system has sufficient resources to serve the new call / connection. This technique is the least complicated CAC algorithm and at the same time it is easy to implement. Another classic approach to admission control in cellular networks assumes allocation of dedicated resources for higher priority calls / connections (so called Guard Channel - GC) [9]. Guard Channel approach has been originally proposed in [10] for cellular networks. In this technique part of resources always remains reserved for higher priority connections (so called Fixed Guard Channel). This technique is adapted to WiMAX in [11] - [13] in order to prioritize handoff connections over arriving connection requests, thus ensuring required QoS for handoff connections. In Fixed Guard Channel, if there are multiple service classes present (as in e.g. WiMAX), an optimal value of guard channel is calculated usually using multidimensional Markov chains. However this process is relatively computationally intensive and may prove difficult to conduct in real-time for changing radio environment. This problem can be minimized by using a vector / table containing pre - defined, GC values optimal for a given traffic conditions [14]. Defining appropriate configurations for such a vector / table may prove hard / inefficient for systems with multiple classes of services, systems with ACM etc.

In [14] authors use reinforcement learning (Q-learning) algorithm to construct dynamic call admission control policies - TQ-CAC and NQ-CAC. TQ-CAC utilizes predefined tables, whereas NQ-CAC takes advantages of neural networks. This solution is evaluated for a cellular network with two classes of traffic. Both presented algorithms achieve lower blocking probabilities of handoff calls and higher rewards than simple greedy CAC scheme. Still, presented algorithms offer similar (NQ-CAC) or worse (TQ-CAC) performance - in terms of blocking probability - than simple guard channel approach.

Admission Control performance in LTE is described in [15]. Authors assume a single cell configuration to assess Uplink Admission Control where the admission criterion of the new user depends on the difference between the total and requested number of Physical Resource Blocks. Other results considering multi cell deployment scenarios are presented in [16] where authors describe and compare static and dynamic CAC in LTE. Additionally a delay-aware connection admission control algorithm is proposed and evaluated. Other approaches for ensuring QoS in LTE networks can be found in papers [17], [18].

On the other hand there are approaches aiming not only at assuring network service quality but also consider the quality as perceived by the end user. Perceived QoS (or Quality of Experience - QoE) is often considered as the "ultimate measure" of system performance. According to ITU-T one can describe QoS as the 'degree of objective service performance' and QoE as the 'overall acceptability of an application or service, as perceived subjectively by the end user' [19]. While QoS evaluation is only a matter of measuring vital network parameters, QoE measurements are much more complicated as they usually involve modelling the human component in the measurement process (in a direct or indirect manner). The user-centric QoE measurement process has been already conducted by ITU-T and captured in Recommendation P.800 [20]. The leading QoE evaluation method for voice is the Mean Opinion Score (MOS). This approach facilitates users' QoE assessment. When



conducting subjective tests the MOS scale is used by users to rate the quality of the perceived audio signal. This makes such QoE measurement impractical as it requires time, resources and equipment. Therefore objective measurement approaches are used to estimate user QoE without the direct involvement of the user itself. A number of QoE measuring methods has been proposed during past years, each of them designed to capture perception relevant measurements (voice, audio). During the DAVINCI project authors have tackled the problem of voice quality measurements for VoIP in wireless IP systems.

Different approaches are proposed and a variety of solutions are investigated on how to evaluate VoIP quality over a wireless link – but only a fraction of them considers WiMAX networks. Some articles focus on the subjective measurement approach as a method for evaluating quality of experience [21] [22] and some try to correlate the subjective measurements with objective approach [23]. Objective approach measurements usually use PESQ (Perceptual Evaluation of Speech Quality) or PSQA (Perceptual Speech Quality Assessment) [24], [25], [26]. Both methods are suitable for single device (telephone) quality assessment but require expensive hardware and laboratory. Due to the constraints present in PESQ and PSQA other objective measurement approaches are proposed. The e-model approach was described in several publications [27], [28], [29] as a method for evaluating QoE over a wireless link using VoIP applications. Variations of the e-model implementation [30] as well as new approaches [31], [32] are investigated to evaluate QoE under QoS-aware mobility mechanisms [33]. In this paper authors focus on QoE solutions designed for wireless environments, especially WiMAX systems [19] [34]. The following section reviews the System-Level Simulation methodology and introduces Cell-Level simulation in WiMAX.

### 3. Cell-level versus system-level simulations

Link-level simulations are typically performed at the first stage of evaluation of a radio technology to provide results and fundamental knowledge of the behaviour of the air interface. Key performance indicators include spectral efficiency, robustness of the codes and modulations, influence of the HPA non linearity and so on. Usually such analysis is accomplished by performing simulations in an environment limited to transmitter and receiver circuitry. The role of PHY Layer simulation is to capture the relevant factors which influence the transmitted signal and to provide basic understanding of radio link-level performance. Real-world WiMAX network deployments are by definition attached to particular geographical area where multiple base stations provide service to hundreds of moving users in an environment characterized by path loss, signal distraction and fading. To evaluate performance of such system with novel FEC codes the standardized system-level simulation methodology has to be considered [1]. The extension of the link-level simulation towards system-level simulation may start by adding multiple users in one cell as defined in [1] and [2]. Numerous studies were conducted towards development of System-Level Simulations methodology and the mandatory recommendations to perform them are given in [1] and [2]. However the above documents do not state how to assess performance of WiMAX with Call Admission Control algorithms. To perform simulations with CAC algorithms authors narrow the scope to a Cell-Level Based approach as presented in Fig. 1.

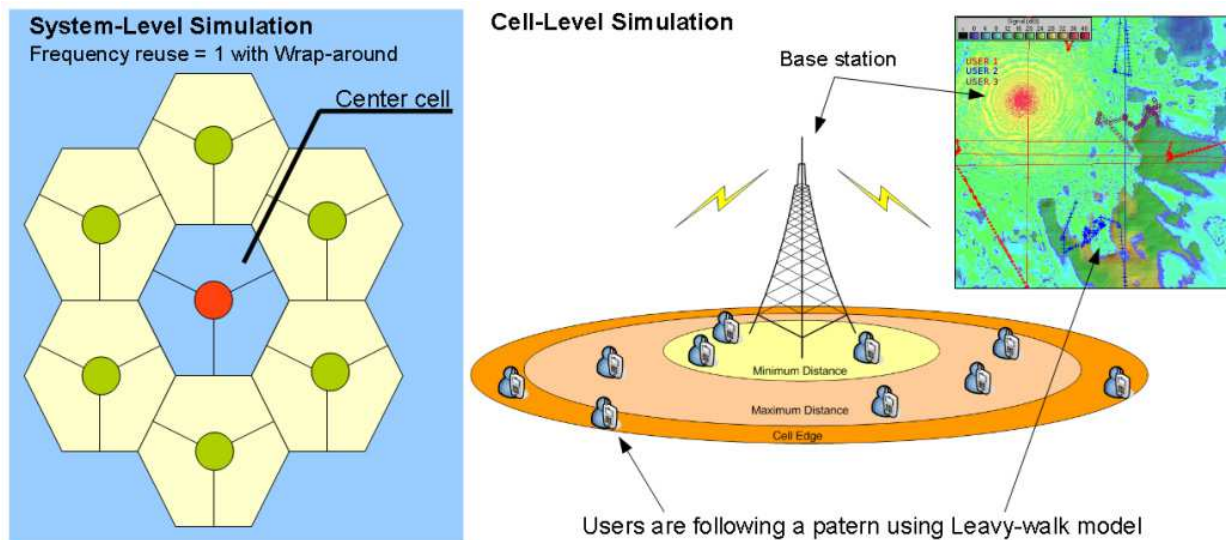

Fig. 1. System-Level Simulations versus Cell-Level Simulations own elaboration based on [1], [5]

As opposed to the approach described in [1] authors deploy one cell with single base station with no cell sectorization (as presented in Fig. 1). This straightforward approach is more suitable for simulations with CAC as it can produce results closer to reality by providing the control of the user movement patterns (conforming to Levy-Walk model [35]) and apply them in a real-life scenario by generating maps with SNR distribution using the Radio Mobile application. In a limited geographical area the movement of mobile users is usually predictable. People are driving or walking to work/school each day taking the same path. In the end they follow a specific pattern on a day-by-day basis [49]. The SNR conditions of each user's channel may vary and depend also on the exact user location at a given moment. This observation is the underlying assumption for our methodology. We first assign a specific mobility pattern to each user. After aligning this pattern with the underlying map, we pick particular SNR values which correspond to the signal strength distribution on the map. Finally this procedure provides us with SNR trace files for our simulator. Each scenario can be repeated numerous times to increase reliability of results. Thus, even though users will take the same path each time, SNR distribution may change due to fading and path loss. The SNR matrices were prepared using the Radio Mobile application. The matrices represent two distinct geographical areas - rural and hilly terrains, both limited to 16 square kilometres. Mobility models are generated using Matlab source files provided by [35]. Radio mobile uses the ITS (Irregular Terrain Model) radio propagation model, developed by Longley & Rice. All calculations in this model are based on the distance of a terminal and the variation of the signal. Signal frequency can vary from 20 MHz to 20 GHz. This general purpose model is used in many fields of science, and can be utilized for WiMAX based network simulations. In the following section the simulation environment based on concept of L2S interface is described.

#### 4. Link to System (L2S) interface

In a real cell-deployment user traffic flows are influenced by various transmission impairments of the air interface. Thus it is important to provide an accurate channel model

which captures the channel characteristics to provide conditions closer to reality. As a preliminary work on WiMAX system performance authors have investigated the capabilities of the NS2 NIST patch and implemented (literature based) Guard-channel based CAC algorithms to measure the performance with nbLDPC codes. The outcome was the development of VIMACCS patch which includes mechanisms for Connection Admission Control deployed for cell level simulation. Implemented and evaluated CAC algorithms for nbLDPC codes included Complete Sharing CAC (CSCAC), Dynamic Hierarchical CAC (DHCAC) and Fair CAC (FCAC) [3][6].

The evident challenges in acquiring reliable simulation environment arise from numerous facts related to physical layer with nbLDPC FEC codes: computational complexity of nbLDPC decoder, the need of adapting decoder implementation to external cell level simulator requirements, requirement for facilitating multiple OFDM subcarriers experiencing different channel conditions.

In the first stage of development it was clear that the (FEC decoder) integration process would be computationally demanding [36]. At that time the available implementation of nbLDPC codes was not optimized for real-time transmission. Thus the decoding process took too much time to be executed on a standard PC with event based simulator in the loop. To reduce the excessive simulation times a method based on effective Signal-to-Noise-and-Interference computation has been evaluated and integrated into Matlab. This method is used to produce a PHY Layer abstraction which in turn can be deployed with different realizations of the decoder. By using eSINR computation we can omit the need for implementing the decoder and in result decrease the computation time. This method is described in the evaluation methodology documents [1] [2] and referred to as the Link-To-System mapping interface. First we compute the AWGN vs. CWER curves for every Modulation Coding Scheme (MCS) using the nbLDPC decoder. The results are not only useful for the PHY Layer abstraction but also provide basic information about the link-level performance. Once the AWGN vs. CWER lookup tables have been generated they can be used to predict the CWER value in mobile non-linear channels. In result we obtain AWGN Lookup Tables (LUTs) which, when used together with a L2S interface, can be used instead of the decoder itself and provide accurate CWER prediction in mobile channels. For more information about performing effective SINR computation the reader is referred to [37] and [38]. Authors decided to use a method based on Mutual Information [1] [37]. In particular the Mutual Information Per Received Bit (RBIR) method was implemented. The Mutual Information is calculated according to formula:

$$SI(SINR_n, m(n)) = \log_2 M - \frac{1}{M} \sum_{m=1}^M E_U \left\{ \log_2 \left( 1 + \sum_{k=1, k \neq m}^M \exp \left[ -\frac{|X_k - X_m + U|^2 - |U|^2}{1/SINR_n} \right] \right) \right\} \quad (1)$$

In the above equation we take  $U$  as the zero mean complex Gaussian with variance  $\frac{1}{2}(SINR_n)$  per OFDM symbol, where  $SINR_n$  is the post-equalizer SINR at the  $n$ -th symbol or sub-carrier;  $m(n)$  is the number of bits at the  $n$ -th symbol (or sub-carrier) and  $X$  is the constellation alphabet. Now assuming that a number of  $N$  subcarriers was used to transmit a codeword (in case FFT-256 is used  $N$  is equal to 192) then the normalized mutual information per received bit (RBIR) is given by:



$$RBIR = \frac{\sum_{n=1}^N SI(SINR_n, m(n))}{\sum_{n=1}^N m(n)} \quad (2)$$

Eventually the above mentioned equations are used to model the behaviour of a mobile radio channel and to generate LUT tables with ESINR values. The LUT tables follow the behaviour of physical layer with a decoder implementation, but without the complexity trade-off. In turn L2S can be used within NS2 simulator to provide more realistic results for simulations with CAC in mobile channels. Since we want to compare system capacity/performance for given FEC schemes, two distinct LUT tables were generated - one for nbLDPC codes and one for CTC.

Network configuration parameters	Value
Carrier frequency	3.5 GHz
Bandwidth	3.5 MHz
Number of sub-carriers	256
Number of data sub-carriers	192
Cyclic prefix	1/8
Modulation	QPSK, 16-QAM, 64-QAM
Coding scheme	nbLDPC, CTC
Codeword length	48, 96, 144, 288
Rates	1/2, 2/3, 3/4, 5/6
Velocity	0.83 m/s
Scheduler	Priority scheduler
Traffic type	UDP CBR or VBR
Transmission direction	Uplink

Table 1. Configuration parameters for integrated simulator

The LUTs were calculated with the assumption that Adaptive Modulation and Coding (AMC) mechanism is enabled thus the target CWER value of ca.  $10^{-3}$  is selected - see Table 5 for details. A more detailed simulator configuration is provided in Table 1.

## 5. Connection admission control performance assessment - WiMAX networks

This section presents the results of test methodology that focused on the three major questions:

- What is the system capacity and performance when different FEC codes are deployed (CTC, nbLDPC) under declaration based admission control and varying system load?
- To what extent does the capacity change if some users follow the VoIP traffic pattern with silence-suppression enabled - depending on the admission control algorithm used (EMAC, ARAC)?

The above questions have been assessed by applying the testing methodology that assumes worst case user mobility [39]. In simulations with admission control we decided to follow an approach similar to the one presented in [40]. This approach assumes that admission control

could be triggered not only by the arrival of a new connection request. Such an approach seems logical in a system utilizing adaptive coding and modulation, since resource requirements of a given connection can change over time. Therefore admission control is triggered in situations when:

- new connection request arrives
- peer’s MCS (Modulation and Coding Scheme) changes
- parameters of a given service flow have been changed.

Since admission control is triggered also when parameters of a given flow have been changed, admission control algorithms are functioning also as Congestion Control algorithms. In this chapter we have evaluated the three following admission control algorithms:

- Complete Sharing Admission Control (CSCAC)
- EMA – based Admission Control (EMAC)
- Arrival Rate aided Admission Control (ARAC) – modified version of the algorithm proposed in [41].

Complete Sharing Admission Control is a parameter based admission control making admission decision based on the declarations provided by arriving connections requests. Connections are accepted as long as there are free resources available at the base station. CSCAC is used in simulations with nbLDPC and CTC codes (section 5.2).

Moreover two measurement-based admission control algorithms (MBAC) have been compared (section 5.3). First we propose a measurement based connection admission control algorithm for the CAC module, which is aware of the current network state and is able to cope with the problem of batch arrivals. It is called Arrival Rate aided Admission Control (ARAC or ARAC) and represents another approach to Measurement-Aided Admission Control (MAAC) algorithm presented in [41]. We then compare the proposed ARAC algorithm with algorithm utilizing exponentially moving average (EMA-MBAC) this algorithm has also been presented in [41] and in this chapter is referred to as EMAC. Since EMAC does not provide protection against problem of estimating resources when connections start arriving in large batches (EMAC underestimates number of used symbols - Fig. 2), in [41] authors propose a threshold – based solution.

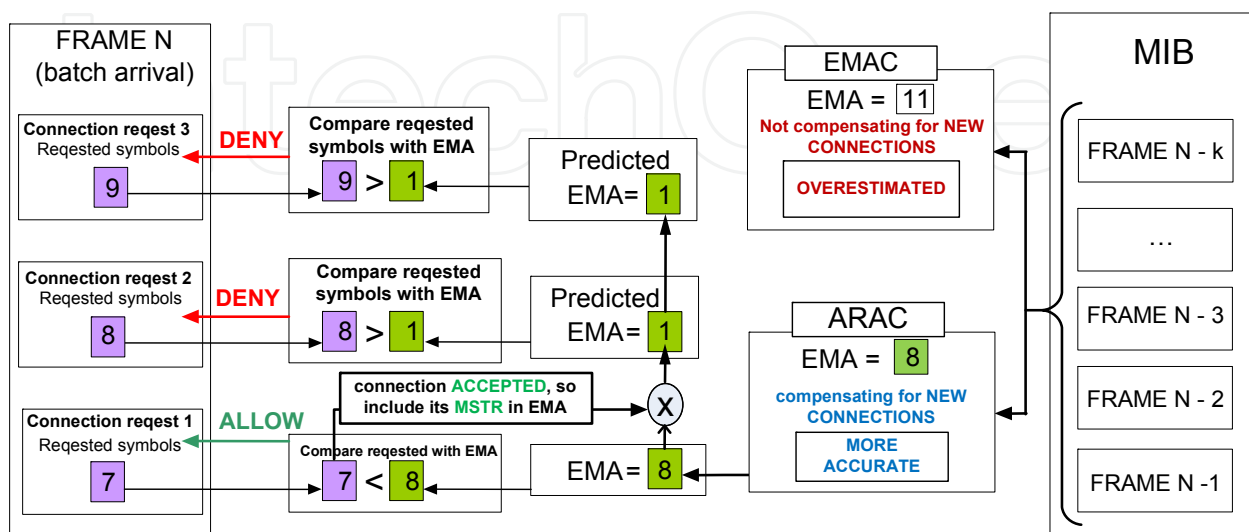

Fig. 2. EMAC vs. ARAC – example of the process of estimating resources for four frames

Value of guard channel (threshold) is adjusted based on the value of the declared Minimum Reserved Traffic Rate (MRTR) of existing connections and recent bandwidth utilization. Instead of using predefined thresholds, the proposed ARCAC takes an advantage of the fact that Base Station (BS) has the ability to monitor information about current arrival rate. Based

EMAC:

```

for each frame  $N_i$  in the current measurement window  $T_{window}$ :
{
     $S_{all}$  = number of all symbols of frame  $N_i$ 
    //  $S_{used}$  = sum of symbols used by ongoing connections during frame  $N_i$ 
    for each connection  $C_j$ :
    {
         $S_{C_j}$  = symbols used by  $C_j$ th connection during frame  $N_i$ 
         $S_{used} = S_{used} + S_{C_j}$ 
    }

     $S_{req}$  = number of symbols required by incoming new connection (based on connection's MSTR)

    //compute predicted free symbols during  $N_i$ th frame
     $S_{pred\_i} = (S_{all} - S_{used} - S_{req}) / S_{all}$ 
    treat  $S_{pred\_i}$  as the  $i$ th sample for EMA calculations
}

when finished compute EMA of free resources

are there enough free resources to accept connection?
YES -> accept connection
NO -> reject connection

```

Fig. 3. Pseudo code for EMAC algorithm

```

for each frame  $N_i$  in the current measurement window  $T_{window}$ :
{
     $S_{all}$  = number of all symbols of frame  $N_i$ 
    //  $S_{used}$  = sum of symbols used during frame  $N_i$  taking into consideration:
    // a) connections ongoing during  $N_i$ th frame
    // b) freshly accepted connections that did not exist during  $N_i$ th frame

    for each connection  $C_j$ :
    {
         $T_{conn}$  = time the  $C_j$  connection exists
        // ? does the connection  $C_j$  exist longer than the measurement window?
        // and ? did the connection  $C_j$  exist already in the current  $N_i$ th frame?
        if ( $T_{conn} > T_{window}$  and  $T_{conn} > T_{currentFrame}$ ) {
            // the connection did exist during current frame
             $S_{C_j}$  = symbols used by  $C_j$ th connection during frame  $N_i$ 
        } else {
            // the connection did not exist during current frame
             $S_{C_j}$  = predict symbols that the  $C_j$ th connection would have used using e.g. MSTR
        }
         $S_{used} = S_{used} + S_{C_j}$ ;
    }
     $S_{req}$  = number of symbols required by incoming new connection (based on connection's MSTR)

    //compute predicted free symbols during  $N_i$ th frame
     $S_{pred\_i} = (S_{all} - S_{used} - S_{req}) / S_{all}$ 
    treat  $S_{pred\_i}$  as the  $i$ th sample for EMA calculations
}

when finished compute EMA of free resources

are there enough free resources to accept connection?
YES -> accept connection
NO -> reject connection

```

Fig. 4. Pseudo code for ARAC algorithm

on this value BS calculates, if the measured EMA of resources used does take into consideration recently accepted connections. If connection requests start arriving in large batches, in order to predict future value of average free symbols ARCAC also takes into consideration QoS parameters (e.g. MSTR) of connections that have already been accepted, but do not exist long enough to influence average symbols utilization (Fig. 2). Below we present the pseudo - code of both EMAC (Fig. 3) and ARAC (Fig. 4).

### 5.1 Traffic characteristics for simulations with CAC

All simulated nodes are generating VoIP traffic which is widely used for its suitability for evaluating QoS performance (stringent QoS requirements) although large number of streams is needed to shift the system under test towards its capacity limits. There are two types of traffic characteristics used throughout the simulation – namely CBR (Constant Bit Rate) and VBR (Variable Bit Rate) streams. The contributing nodes include thirty WiMAX nodes for each simulation, although intensity of the requests for connections sent by each one is governed by generator that fulfils requirements of a given arrival rate.

The VBR flows are represented by VoIP traffic streams conforming to the ON-OFF distribution typical for voice codecs with silence-suppression. Thus depending on the type of codec used user packets are classified as the UGS traffic class (CBR) or rtPS (when silence-suppression is used). The UGS connections are transmitting packets with CBR and 64 kbps. For VBR rtPS VoIP we use two codecs – namely G.711 and G.729 with “one-to-one” voice detection model. In order to use realistic VoIP traffic models, the NS2 VoIP traffic generators developed as part of EuQoS European project [42] were integrated into our simulator (ViMACCS).

All simulated users are assumed to be mobile. Their mobility path follows the well-known mobility pattern – namely Levy-walk distribution. To increase the reality of the simulated environment a COTS tool for coverage planning was used to provide SNR distribution in a given geographic area. Since the first aim of early stages of measurements (section 5.2) was to evaluate system capacity, it was essential to overload the base station. This condition can be achieved sooner if large (1000B) packets are being used. On the other hand, in order to fulfil the requirements of the ITU G.107 QoE method, packets should be small (64B). Thus the results in section 6.3 are following similar configuration but with smaller packets. The following section shows the results obtained during cell-level simulations with CAC.

### 5.2 Parameter based admission and congestion control with nbLDPC and CTC FEC schemes

In this scenario we compare results obtained for the two aforementioned FEC schemes – nbLDPC and CTC. We assume “worst - case” scenario where all users are moving in a dynamically changing SNR environment.

As mentioned before, user mobility patterns are generated according to the Levy-Walk model [35]. SNR map has been generated for two villages – one near the city of Warsaw (Poland) and one near the city of Katowice (Poland). The *Map 1* represents good SNR conditions (on average) whereas *Map 2* mimics a bad SNR environment. The arrival rate of user requests follows Poisson process. The CSCAC is configured to handle both admission and congestion control algorithm. Simulation parameters have been presented in Table 2. The code word error rate (CWER) for both FEC schemes in presence of ACM is assumed to

be 1%. All simulations have been repeated 20 times in order to increase statistical reliability of results. All figures present average values together with 95% confidence interval.

For simulations with nbLDPC we can observe lower Dropping Probabilities (Fig. 5) than for simulations with CTC. This is due to less MCS transitions (Fig. 6) as for similar simulation conditions there is less MCS changes for the nbLDPC codes. This results in average system throughput being slightly higher (by 5-10%) for simulations with the nbLDPC FEC (Fig. 7) as less resources are freed prematurely due to connections being dropped. This also finds reflection in BW utilization, which is slightly higher for nbLDPC (Fig. 8), and Blocking Probability (Fig. 9), which is higher for nbLDPC (fewer resources freed prematurely means higher probability that new connection requests will be rejected due to insufficient resources). It has to be noted that data connection's MCS change triggers admission control - thus in high mobility scenarios the offered traffic arrival rate should be adjusted by the average number of instantaneous MCS changes to make it realistic from a resource point of view.

Network configuration parameters	Value
Arrival rate	20 to 140 conn/minute (Poisson)
SF class	UGS
Average Connection Time	20 s (exponential)
Traffic characteristics	UDP CBR (1000 B at 20 ms)
FEC	CTC   nbLDPC
L2S	Enabled
MAP	Enabled - MAP 1; MAP 2
Simulation time	200 s
CAC	CSCAC (parameter - based)
Congestion Control	Enabled
Scenario Repetitions	20
CWER	0.01

Table 2. Configuration for CAC simulation with two FEC schemes

Network configuration parameters	Value
Arrival rate	25 to 250 conn/minute (Poisson)
SF class	UGS   rtPS
Average Connection Time	20 s (exponential)
Traffic characteristics (Codecs)	G.711 G.729
Voice Detection Model	One-to-one
L2S	Enabled
MAP	MAP 1
Simulation time	200 s
CAC	MBCAC   ARCAC
Congestion Control	Enabled
Scenario Repetitions	8
FEC	nbLDPC
CWER	0.01

Table 3. Configuration for simulations with the two MBCAC algorithms



In case of a environment with lower average SNR values, the nbLDPC gain observed for Map 1 is still present for Map 2, but becomes almost negligible (e.g. in terms of average system throughput - Fig. 10). This is due to nature of nbLDPC codes, as nbLDPC gain is most visible for high order modulations. In case of low SNR, when more robust modulations are being used (e.g. QPSK), nbLDPC gain becomes insignificant. It is worth noticing, that results obtained in this section are similar to the results obtained by authors in [43] where DAVINCI/nbLDPC gain in average sector throughput has been found to be approximately 5% higher compared to that achieved with CTC codes.

### 5.3 Measurement based admission and congestion control with nbLDPC FEC scheme

In this section we compare two measurement based admission control (MBCAC or MBAC) algorithms. Approach to simulation environment remains the same as for section 5.2 although within the set of mobile nodes there are now 60% of users that use VoIP codecs with silence suppression enabled. For all VoIP sources we assumed one - to - one conversation model.

Simulations are conducted only for *Map1*. In order to be able to measure performance of MBCAC algorithms alongside CBR VoIP traffic we introduce VBR VoIP traffic with silence suppression, which is marked as rtPS traffic. The amount of nodes using each type of VoIP traffic is equal (eg. 10 users with G.711, 10 with G.729 and 10 with CBR). The nbLDPC (DAVINCI) FEC scheme is used for all simulations. As in previous section admission control algorithm is used also as a congestion control algorithm.

All the figures below present average values together with 95% confidence interval (outliers in the charts). Simulation parameters can be found in Table 3. Figures Fig. 11 to Fig. 13 present average delays for VoIP for both tested Admission Control algorithms. It can be observed, that all VoIP connections experience lower delays when ARAC is used as admission control algorithm.

The reason is that if multiple connection requests arrive in a short period of time, ARAC can estimate remaining resources more accurately than EMAC. This becomes more evident for high arrival rates. For G.711 codec and high arrival rates difference in delay reaches approximately 25% and for G.729 approximately 23%. These findings are in compliance with the results obtained by researchers in [41], where using EMAC algorithm also caused increase in delay. The highest sensitivity to increased arrival rate can be observed for VoIP connections with silence suppression. These streams are scheduled as rtPS service class (G.711 and G.729).

UGS always takes priority over rtPS, thus its delay remains virtually constant. At the same time Blocking Probability for ARAC is similar to EMAC (approx. 2% difference for high arrival rates - Fig. 14). If we assume, that each MCS change should trigger CAC algorithm (working as a congestion control), EMAC is characterized by moderately lower Dropping Probabilities (ap. 14% for high arrival rates - Fig. 15). Although delay observed for both CAC algorithms is still acceptable for VoIP conversation it should be noted, that tests have been conducted assuming end application is located in the local network adjacent to the BS serving the VoIP source, therefore assuming the core network delay to be “zero” between the caller and callee. Therefore it should be noted that depending on the core network delay (especially when it exceeds 80ms) the ARAC should be considered a more robust choice.

Results obtained in this section show that ARAC provides means to cope with batch arrivals. As it utilizes data available at BS rather than incrementally adjusts values of guard channel, it can be considered as an alternative choice to threshold - based solutions like MAAC presented in [41].

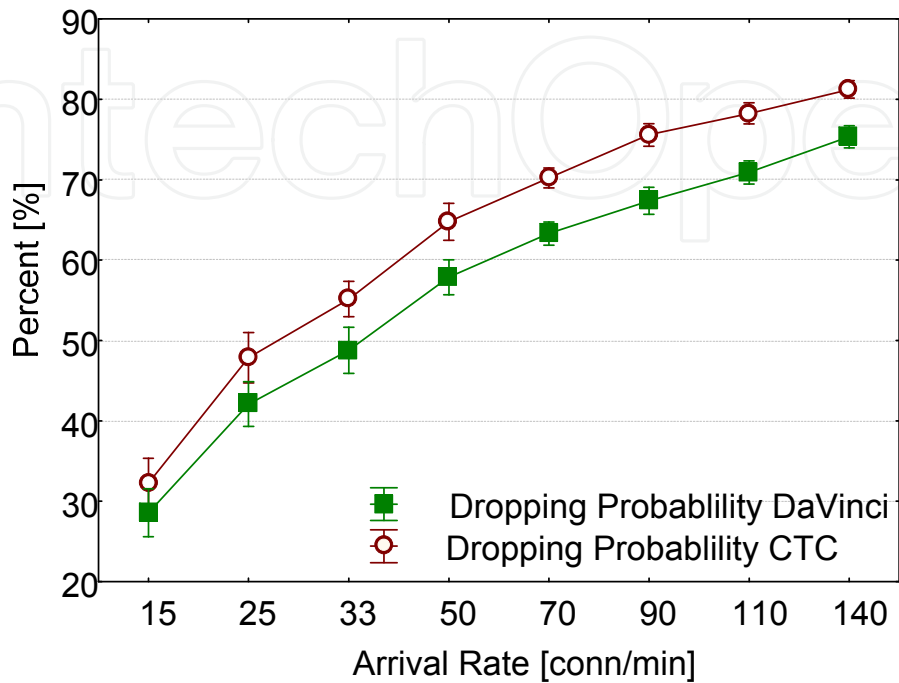

Fig. 5. Dropping Probabilities for DV and CTC Map1

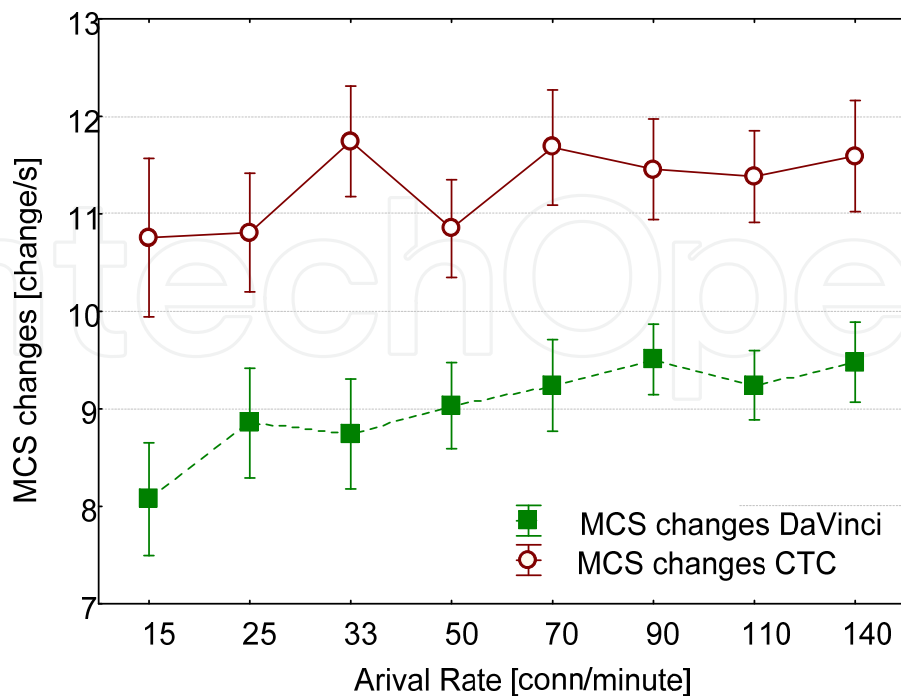

Fig. 6. MCS changes for DV and CTC Map1

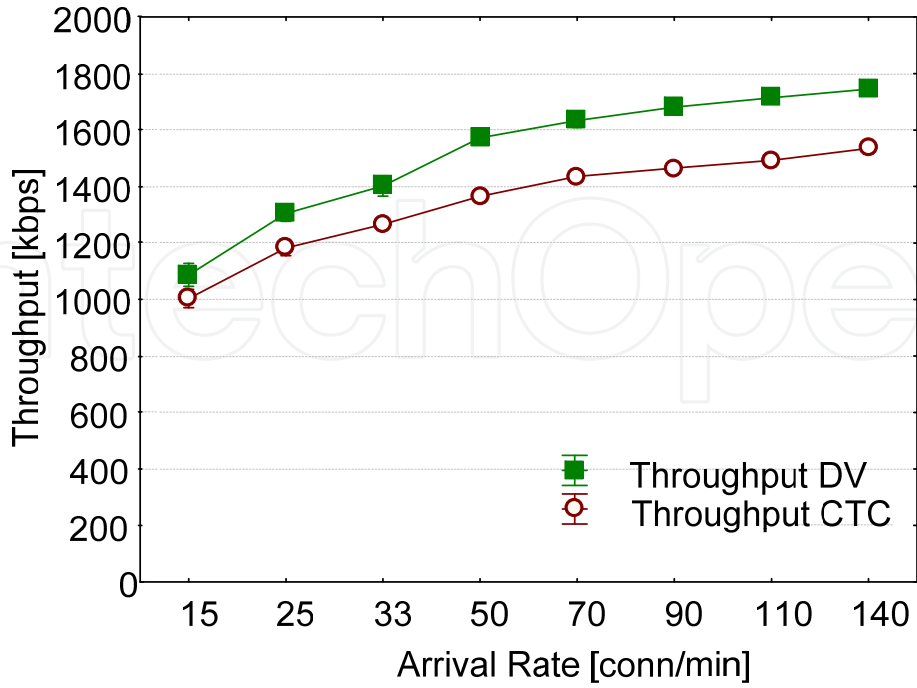

Fig. 7. System throughput for DV and CTC - Map1

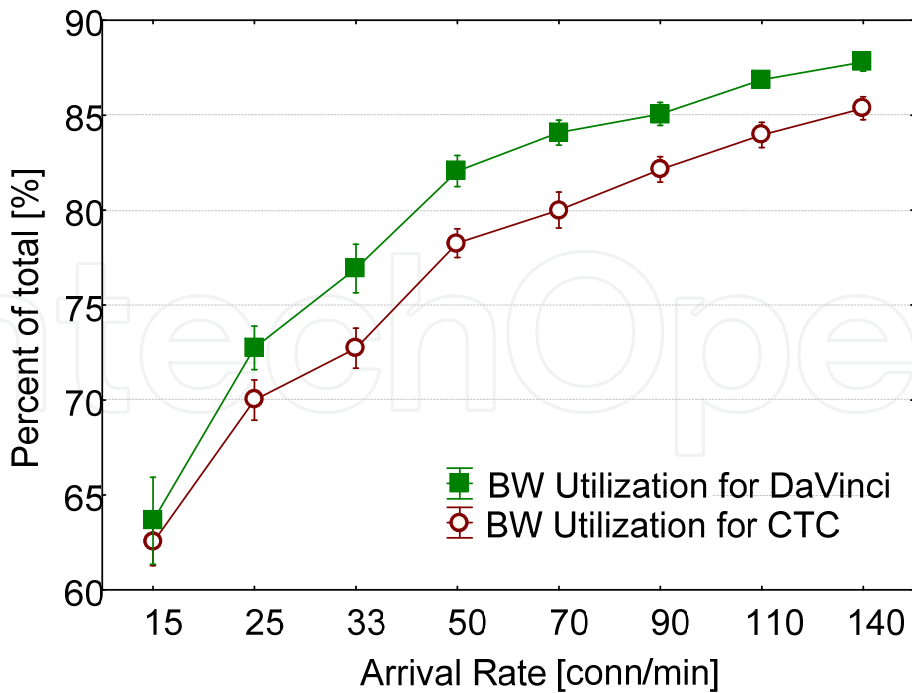

Fig. 8. Bandwidth utilization for DV and CTC - Map 1

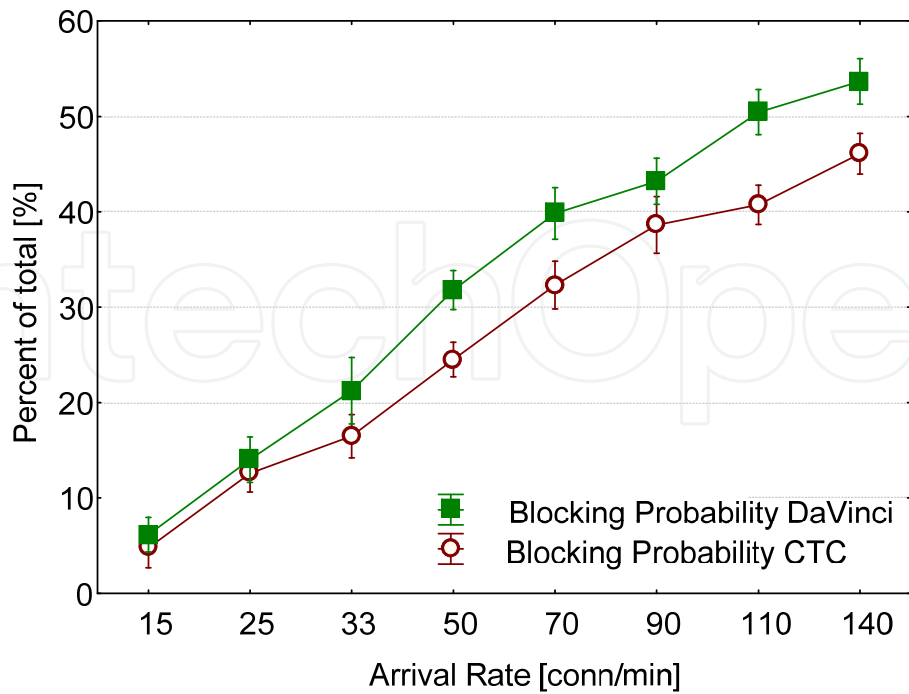

Fig. 9. Blocking probabilities for DV and CTC - *Map1*

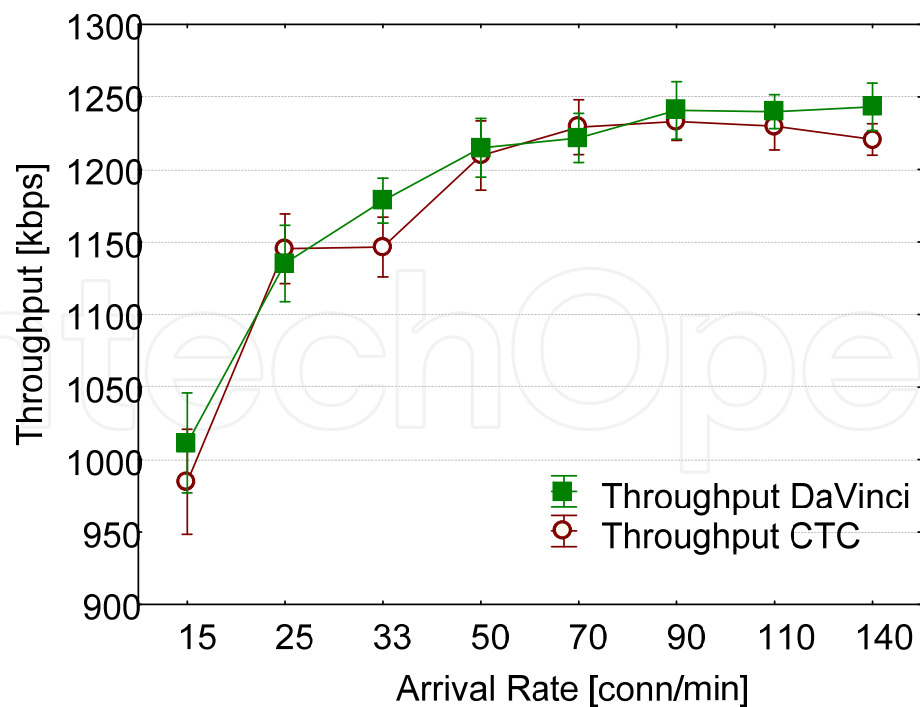

Fig. 10. System throughput for DV and CTC - *Map2*

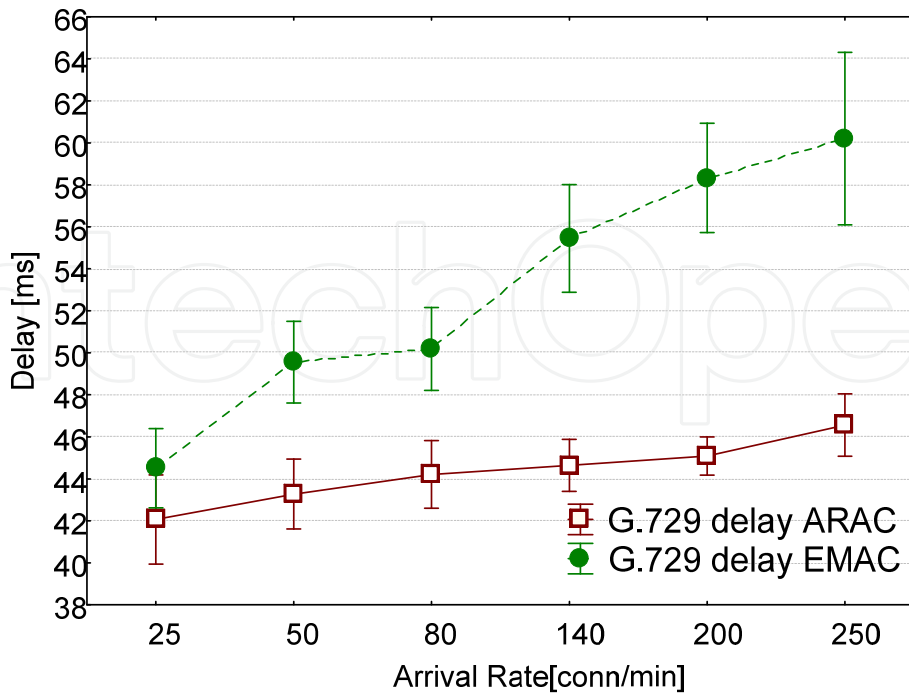

Fig. 11. G.729 VoIP delay for ARAC and EMAC (rtPS)

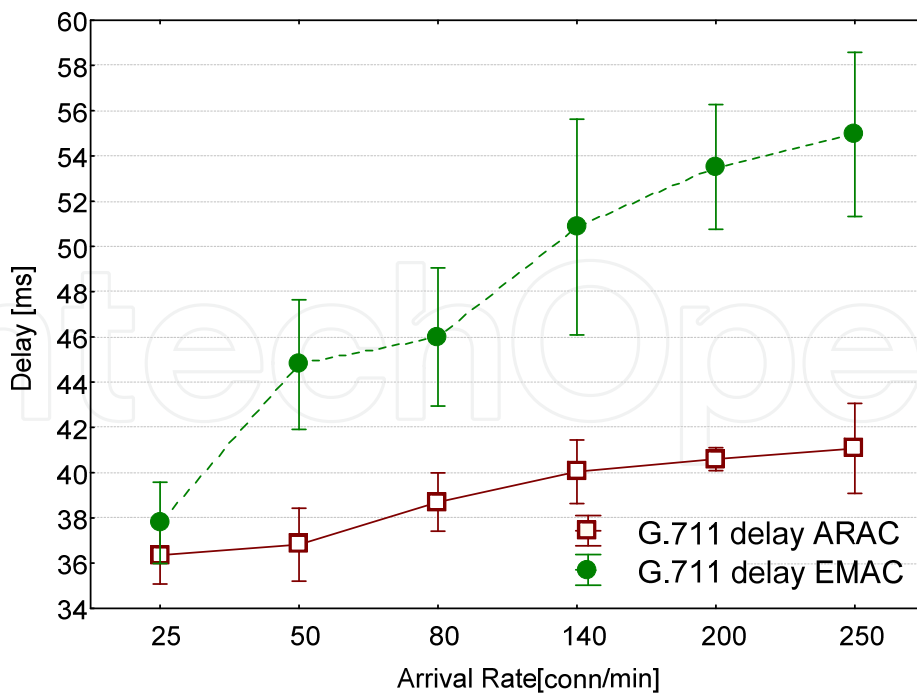

Fig. 12. G.711 VoIP delay for ARAC and EMAC (rtPS)



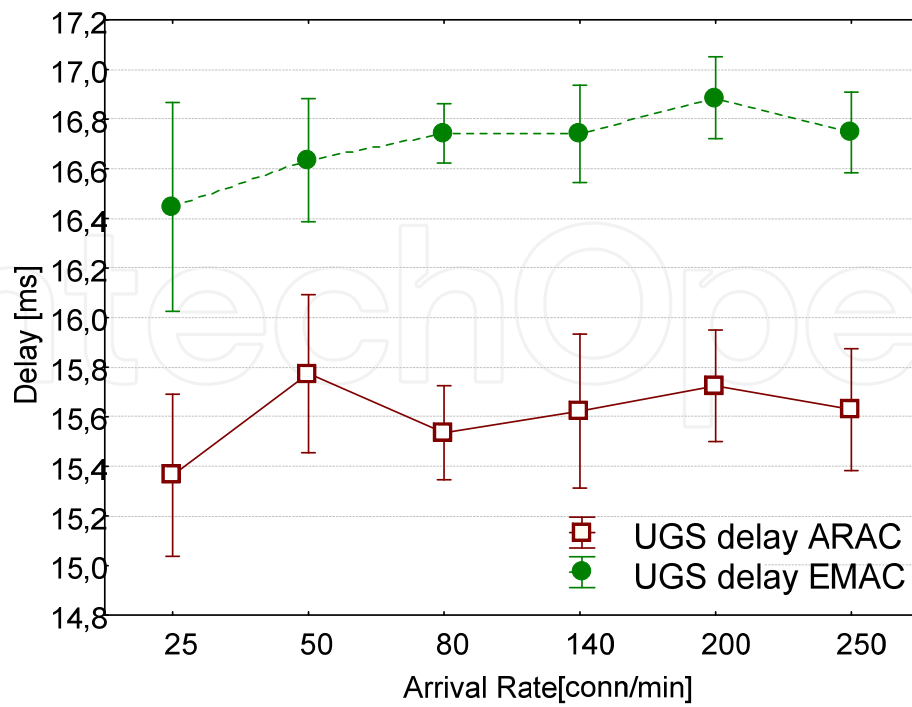

Fig. 13. CBR VoIP delay for ARAC and EMAC (UGS)

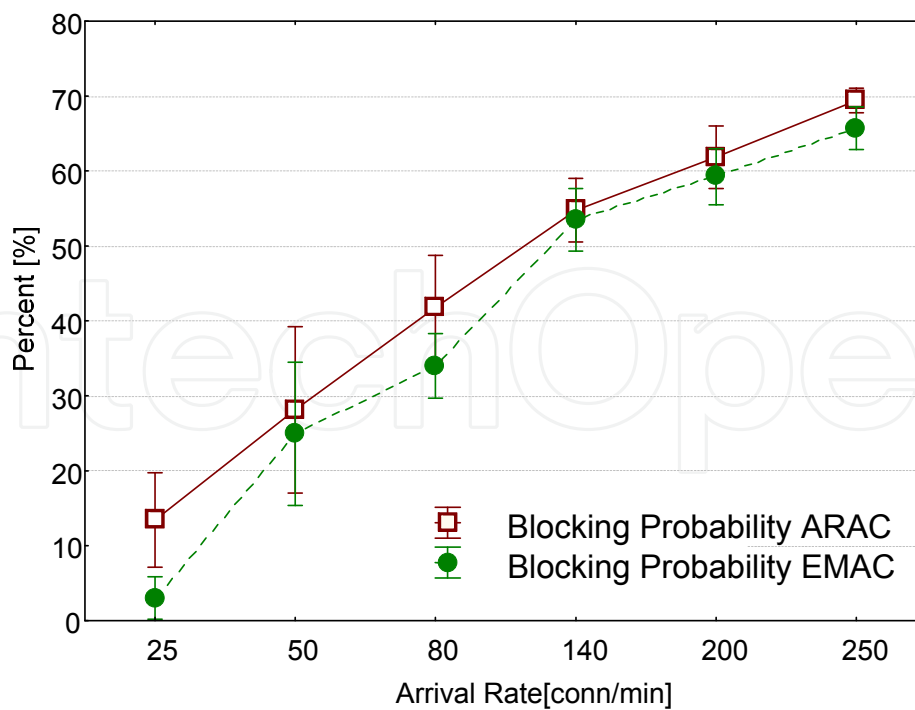

Fig. 14. Blocking probabilities for ARAC and EMAC

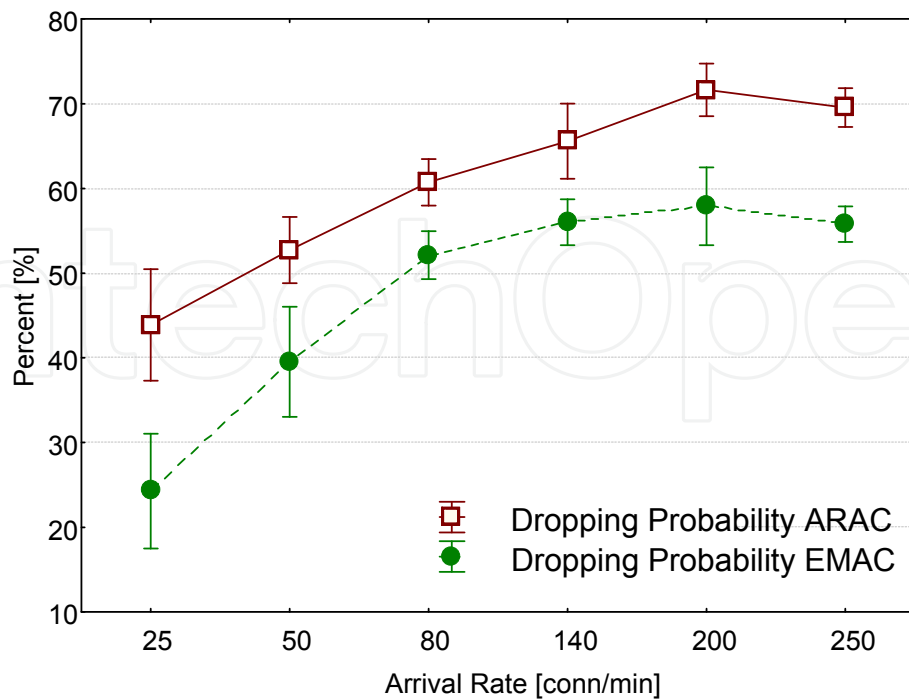

Fig. 15. Dropping probabilities for ARAC and EMAC

## 6. QoE VoIP performance assessment in WiMAX networks

Among key goals of our research was to assess the degree to which the new coding scheme affect the voice quality as perceived by the VoIP user using conversational service (VoIP). Since measurements using COTS HW implementing LDPC are not feasible (at the moment of writing) with nbLDPC codes authors implemented Matlab based E-model to estimate an appropriate grade of the signal quality in form of R-factor.

### 6.1 E-model for QoE calculation

The E-model (ITU G.107) was originally used to help PSTN network planners and telephone service providers to perform basic evaluation test for voice quality to determine the system requirements for telephone line [44]. However there are several publications which prove that a consistent and reliable approach towards the adoption of the E-model in an IP wireless environment for VoIP quality assessment is possible [45], [46]. The authors are using the simplified model that adjusts the equations defined by ITU-T for PSTN E-model to assess VoIP connection quality as proposed in [45]. The output of the E-model is calculated as follows:

$$R = 93.35 - I_d - I_e + A \quad (3)$$

Where  $I_d$  is the delay impairment and  $I_e$  the packet loss impairment. The calculated R-factor can be further used to map the objective measurement to subjective MOS scale resulting in an approximation of the user perceived quality. This allows overcoming the disadvantages of the subjective approach and achieve reliable results as shown in [45]. This approach has also been employed by authors in article [47].

## 6.2 Simulation parameters

In this subsection authors describe the simulation scenario used to perform QoE assessment. User's application is sending 200B voice packets in a 20 ms time interval. Each simulation run requires a number of repetitions and for each set of repetitions the number of users in the system increases as specified in Table 4. The number of users was chosen to show the point where the perceived quality falls below acceptable limits (from the point with most users satisfied to dissatisfied). Additionally in the scenarios users are moving at a constant speed of 3 km/h (pedestrian speed). They follow Levy-walk mobility pattern on a map generated by radio planning tool [5]. In this scenario it is assumed that both CAC and congestion control algorithms are turned off. Simulations are performed for ACM with nbLDPC and CTC codes. The simulation parameters are gathered in Table 4.

The next section presents the results obtained during simulations with NS2 and the L2S physical layer abstraction interface (described above). The results include the delay, packet loss impairments and show how this parameters influence the perceived quality (in R-factor scale).

Parameter	Value
Nodes	30 to 33 (for MAP 1), 23 to 26 (for MAP 2)
SF class	UGS (no rtPS)
Traffic	UDP CBR (200 B at 20 ms)
FEC	CTC   nbLDPC
L2S	Enabled
MAP	Enabled (Map1, Map2)
Mobility	All users are mobile
Velocity	3 km/h
Simulation time	200 s (for MAP 1), 100 s (for MAP 2)
CAC	Disabled
Congestion Control	Disabled
Scenario Repetitions	6 (for MAP1), 3 (for MAP2)

Table 4. Parameters for simulation scenario

## 6.3 Results for VoIP QoE

In this subsection authors present the results of evaluating the QoE of a VoIP connection in WiMAX network. Authors measured latency (Fig. 16) and packet loss (Fig. 17) as a function of the number of active users in the system. The measurements were conducted for both maps. The captured parameter values were fed into the E-model equations for computing the R-factor Fig. 18.

The resulting R-factor represents the estimated degradation of QoE. The results depicted in Fig. 18 show that the R-factor is within acceptable limits for up to 32 (MAP1) and 25 (MAP2) users respectively. As more users are being served in a cell the quality drops instantly. A small performance gain of nbLDPC codes over CTC was achieved in terms of QoE. For simulations with worse SNR conditions (*Map2*) the nbLDPC gain further increases. Additionally when comparing the results for *Map1* and *Map2* it can be seen that QoE drops very fast when the channel conditions are bad (low SNR values).

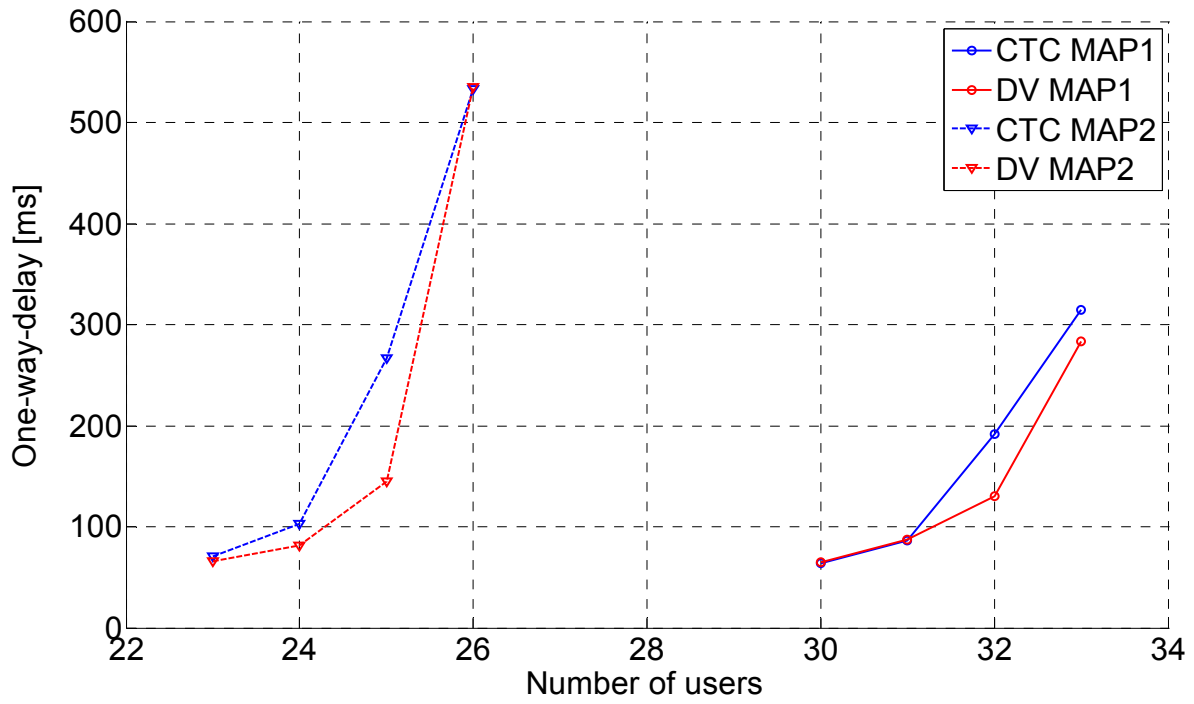

Fig. 16. Average delay for DV (nbLDPC) and CTC

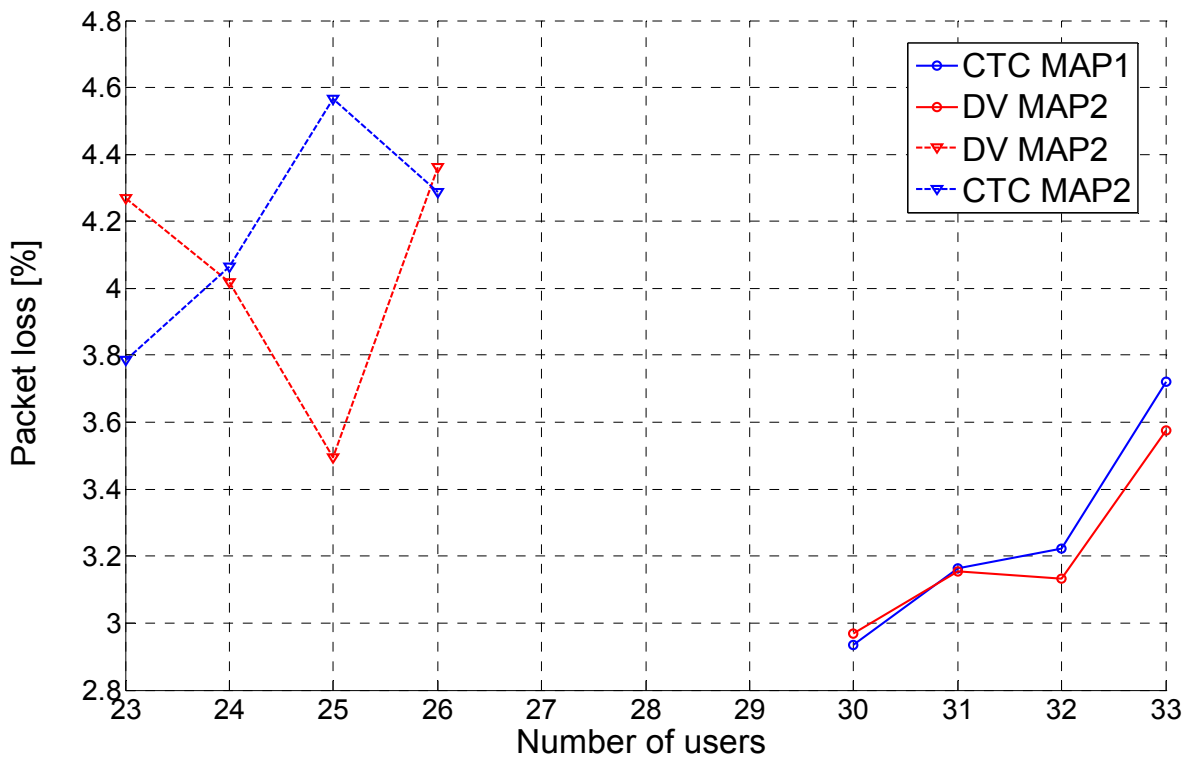

Fig. 17. Average packet loss for DV (nbLDPC) and CTC

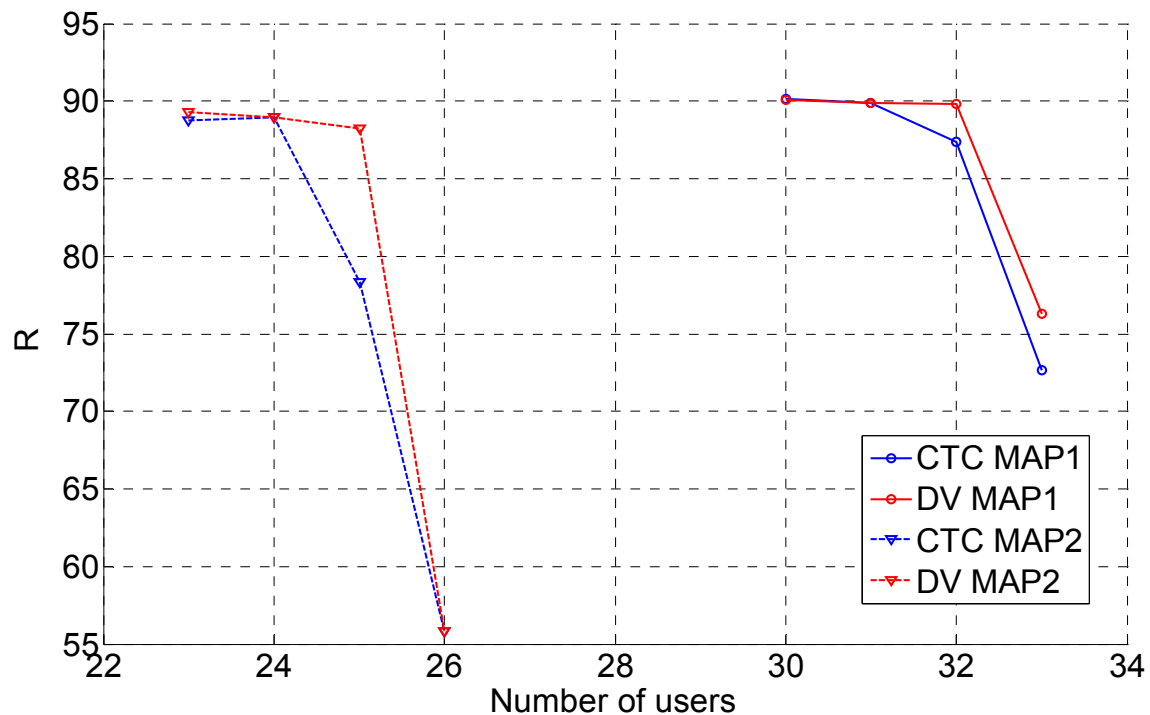

Fig. 18. R-factor for DV (nbLDPC) and CTC

## 7. Conclusions

The main focus of this chapter was to apply simulation methodology to facilitate cell - level simulations covering QoE measurements and CAC in WiMAX network with Time Division Multiplexing Access scheme (TDMA), OFDM and uplink traffic. The research addresses also the topic of what impact the dynamics of the system (such as resource optimization techniques e.g. AMC) has on admission control and quality of service. In order to evaluate the performance of envisaged algorithms and assess their impact on the system, authors have developed a cell-level simulation environment that relies on the proposed methodology. Previous work in the field is enhanced by improving the fidelity level of the proposed IEEE 802.16 simulator. In order to compare SUT's performance using either nbLDPC or legacy CTC (Convolutional Turbo Coding) codes in a mobile channel, a method called Link-To-System interface (L2S) has been implemented. In particular a method based on mutual information (MI) called RBIR (Mutual Information Per Received Bit | Received coded Bit Information Rate) was selected. The simulation environment relies on Network Simulator 2 integrated with Matlab software.

For admission control simulations with nbLDPC and CTC codes we come to conclusion, that achievable gain of nbLDPC can only be observed if users experience relatively good channel conditions. For higher modulations we observe less MCS transitions for nbLDPC codes, which results in lowering dropping probability and slightly increasing average system throughput. Nevertheless if users experience moderate or bad channel conditions, gain achieved thanks to nbLDPC codes becomes insignificant.

System under test (SUT) controls resources using either novel admission control mechanism ARAC (adopted by authors) or its predecessor EMAC, introduced in [41]. The algorithms



are both traffic – aware and designed for controlling the VBR traffic with burst arrivals but one of them relies on calculating simple exponential weighted moving average (EWMA) of the overall resource consumption, whereas the other in the process of resource estimation differentiates between the new and the ongoing connections, thus providing more accurate resource estimations. Simulation results show that both of presented algorithms can provide appropriate QoS levels in the tested configuration. However ARAC provides protection against connections arriving in large batches. Therefore average delays of ARAC are generally lower than that of EMAC and reach the difference of approximately 23 – 25ms at maximum (depending on the codec used). These differences could prove crucial in a system with non – negligible core network delays. Results of CAC comparison prove that proposed ARAC algorithm decreases the delay experienced by VoIP connections the more the higher the arrival rate for the cost of increased blocking probability

Eventually authors provide results of assessing quality of VoIP (Voice Over IP) conversations. CTC and nbLDPC codes are compared in terms of system capacity and resulting quality of experience (QoE) performance of VoIP flows. It is shown that DaVINCI/nbLDPC codes outperform CTC in the total cell utilization and decreased dropping probability. The QoE metrics measured show slightly more users are satisfied in a cell with DaVINCI codes than when CTC is used. Therefore the nbLDPC FEC codes have proven to be a reliable coding scheme.

## 8. Attachments

Below in table (Table 5) the thresholds for the AMC mechanism are given. Code rate, codeword sizes and SNR thresholds are given for the codes being compared (CTC, nbLDPC).

Mod	BPSK		QPSK				16-QAM				64-QAM		
	1/2	2/3	1/2	2/3	3/4	5/6	1/2	2/3	3/4	5/6	2/3	3/4	5/6
Rate	1/2	2/3	1/2	2/3	3/4	5/6	1/2	2/3	3/4	5/6	2/3	3/4	5/6
Codeword length	48	48	96	96	96	96	144	144	144	144	288	288	288
SNR CTC	-0,50	1,20	1,78	3,90	4,97	6,30	7,09	9,69	11,06	12,43	14,35	15,97	17,64
SNR DAVINCI	-0,12	1,37	1,77	4,04	5,17	6,69	7,43	10,03	11,50	12,87	14,52	16,16	17,89
DAVINCI gain	0,38	0,17	-0,01	0,14	0,20	0,39	0,34	0,34	0,44	0,44	0,17	0,19	0,25

Table 5. SNR threshold for DAVINCI and CTC [48]

## 9. References

- [1] IEEE 802.16m Evaluation Methodology Document (EMD), 2008
- [2] WiMAX System Evaluation Methodology, 2008
- [3] IEEE 802.16-2009: Part 16: Air Interface for Broadband Wireless Access Systems, 2009
- [4] Radio Mobile <http://www.cplus.org/rmw/english1.html>
- [5] A. Flizikowski, W. Hołubowicz, M. Przybyszewski, Sławomir Grzegorzewski, "Admission control and system capacity assessment of WiMAX with ACM and

- nb-LDPC codes - simulation study with ViMACCS NS2 patch", The International Conference on Advanced Information Networking and Applications, Perth, Australia
- [6] Adam Flizikowski, Marcin Przybyszewski, Mateusz Majewski, Rafał Kozik, "Evaluation of guard channel admission control schemes for IEEE 802.16 with integrated nb-LDPC codes", International Conference on Ultra Modern Telecommunications, ICUMT St.-Petersburg, Russia 2009
- [7] Alasti M., Neekzad B., Jie Hui, Vannithamby R., "Quality of service in WiMAX and LTE networks [Topics in Wireless Communications]", IEEE Communications Magazine, vol.48, no.5, p.104-111, May 2010
- [8] Anas M., Rosa C., Calabrese, F.D., Pedersen K.I., Mogensen P.E., "Combined Admission Control and Scheduling for QoS Differentiation in LTE Uplink", IEEE 86<sup>th</sup> Vehicular Technology Conference, 2008. VTC 2008-Fall.
- [9] Kalikivayi, S.; Misra, I.S.; Saha, K., "Bandwidth and Delay Guaranteed Call Admission Control Scheme for QoS Provisioning in IEEE 802.16e Mobile WiMAX" Global Telecommunications Conference, 2008. IEEE GLOBECOM 2008. IEEE Nov. 30 2008-Dec. 4 2008
- [10] D. Hong and S. S. Rappaport, Traffic model and performance analysis for cellular mobile radio telephone systems with prioritized and nonprioritized handoff procedures, IEEE Trans. Veh. Technol., 1986, vol. VT-35, pp. 77-92.(9)
- [11] Liping Wang, Fuqiang Liu, Yusheng Ji, and Nararat Ruangchaijatupon. Admission Control for Non-preprovisioned Service Flow in Wireless Metropolitan Area Networks, ECUMN2007, 14-16, 2007, Toulouse, France.
- [12] Kuo G. S., Yao H. J., A QoS-Adaptive Admission Control for IEEE 802.16e-based Mobile BWA Networks Consumer Communications and Networking Conference, 2007. CCNC 2007. 4th IEEE
- [13] Xin Guo, Wenchao Ma, Zihua Guo, and Zifeng Hou, Dynamic Bandwidth Reservation Admission Control Scheme for the IEEE 802.16e Broadband Wireless Access Systems WCNC 2007, 11-15 March 2007(9)
- [14] Sidi-Mohammed Senouci, Andre-Luc Beylot, and Guy Pujolle. 2004. "Call admission control in cellular networks: a reinforcement learning solution." Int. J. Netw. Manag. 14, 2 (March 2004), 89-103.
- [15] Siomina I., Wanstedt S., "The impact of QoS support on the end user satisfaction in LTE networks with mixed traffic", IEEE 19<sup>th</sup> International Symposium on Personal, Indoor and Mobile Radio Communications, 2008. PIMRC 2008.
- [16] Sueng Jae Bae, Bum-Gon Choi, Min Young Chung, Jin Ju Lee, Sungoh Kwon, "Delay-aware call admission control algorithm in 3GPP LTE system", TENCON 2009 - 2009 IEEE Region 10 Conference.
- [17] Anas M., Rosa C., Calabrese F.D., Michaelsen P.H., Pedersen K.I., Mogensen, P.E., "QoS-Aware Single Cell Admission Control for UTRAN LTE Uplink", IEEE Vehicular Technology Conference, 2008. VTC Spring 2008.
- [18] Manli Qian, Yi Huang, Jinglin Shi, Yao Yuan, Lin Tian, Dutkiewicz E., "A Novel Radio Admission Control Scheme for Multiclass Service in LTE Systems", IEEE Global Telecommunications Conference, Issued: Nov. 30 2009-Dec. 4 2009, p.1-4, 2009
- [19] M.D. Katz, F.H.P. Fitzek, "WiMAX Evolution. Emerging Technologies and Applications", Wiley 2009

- [20] ITU-T Recommendation P.800, Series P: Telephone Transmission Quality, Methods for objective and subjective assessment of quality - Methods for subjective determination of transmission quality, 1996
- [21] R.G. Garroppo, S. Giordano, D. Gacono, A. Cignoni, M. Falzarano, "Wimax testbed for interconnection of mobile navy units in operation scenarios", University of Pisa in Italy, May 2008
- [22] T. Deryckere, W. Joseph, L. Martens, "A software tool to relate technical performance to user experience in a mobile context", Department of Information Technology, August 2008
- [23] A.A. Webster, C.T. Jones, M.H. Pinson, S.D. Voran, S. Wolf, "An objective video quality assessment system based on human perception", The Institute for Telecommunication Sciences, February 20
- [24] Perceptual evaluation of speech quality (PESQ): An objective method for end-to-end speech quality assessment of narrow-band telephone networks and speech codecs, Telecommunications Standardization Sector of ITU
- [25] K. Piamratm A. Ksentini, C. Viho, J. Bonnin, "Perceptual evaluation of speech quality (PESQ) : An objective method for end-to-end speech quality assessment of narrow-band telephone networks and speech codecs", University of Rennes, September 2009
- [26] A. Paulo Couta de Silva, M. Varela, E. de Souza Silva, Rosa M.M. Lea, G. Rubino, "Quality assessment of interactive voice applications", Federal University of Rio De Janeiro, January 2008
- [27] R.G. Cole, J.H. Rosenbluth, "Voice over IP performance monitoring", Computer Communications Review, 2001
- [28] L. Carvalho, E. Mota, R. Auiar, A.F. Lima, J.N. de Souza, A. Baretto, "An E-model Implementation for Speech Quality Evaluation in VoIP Systems", 2004
- [29] J.Q. Walker, "Assessing VoIP call quality using the E-model", netIQ
- [30] A. Meddahi, H. Afifi, D. Zeghlache, "Packet-E-Model: E-model for Wireless VoIP Quality Evaluation", IEEE Symposium on Personal, Indoor and Mobile Radio Communication Proceedings
- [31] Hyun-Jong Kim, Dong-Hyeon Lee, Jong-Min Lee, Kyoung-Hee Lee, Won Lyu, Seong-Gon Choi, "The QoE Evaluation Method through the QoS-QoE correlation model", Fourth International Conference on Networked Computing and Advanced Information Management, 2008
- [32] A. Raja, R. Muhammad Atif Azad, C. Flanagan, C. Ryan, Real-Tiem, "Non-intrusive Evaluation of VoIP", Springer 2007
- [33] F. Bernardo, N. Vucevic, A. Umbert, M. Lopez-Benitez, "Quality of Experience Evaluation under QoS-aware Mobility Mechanisms",
- [34] S. Sengupta, M. Chatterjee, S. Ganguly, R. Izmailov, "Improving R-score of VoIP Streams over w WiMAX", University of Central Florida
- [35] North Carolina State Univeristy, Human Mobility Model and DTN Group <http://netsrv.csc.ncsu.edu/twiki/bin/view/Main/MobilityModels>
- [36] A.Flizikowski. R.Kozik, H.Gierszal, M.Przybyszewski, W.Hołubowicz, "WiMAX system level simulation platform based on NS2 and DSP integration", Broadbandcom2009, Wrocław, Poland

- [37] J. Zhang, H. Zheng, Z. Tan, Y. Chen, „Principle of Link Evaluation“, Communications and Network, 2009 06-19 p.6-19
- [38] A. Kliks, A. Zalonis, I. Dages, A. Polydoros, H. Bogucka, „PHY Abstraction Methods for OFDM and NOFDM Systems“, Journal of telecommunications and information technology
- [39] INFSCO-ICT-216203 DA VINCI D5.4.1 v1.0: Evaluation criteria for multimedia services, issue 1
- [40] Olli Alanen; “Quality of Service for Triple Play Services in Heterogeneous Networks”; p. 38-39; University of Jyväskylä 2007; Finland
- [41] J. Lakkakorpi, A.Sayenko *Measurement-Based Connection Admission Control Methods for Real-Time Services in IEEE 802.16e* 2009 Second International Conference on Communication Theory, Reliability, and Quality of Service
- [42] EuQoS project <http://www.euqos.eu/>
- [43] Alain Mourad, Ismael Gutierrez; “System level evaluation, Issue 2”; Jan. 2010, Samsung Electronics UK Ltd., United Kingdom
- [44] ITU-T Recommendation G.107, The E-model, a computational model for use in transmission planning
- [45] R.G. Cole, J.H. Rosenbluth, *Voice over IP performance monitoring*, Computer Communications Review, 2001
- [46] J.Q. Walker, *Assessing VoIP call quality using the E-model*, net1
- [47] A. Flizikowski, M. Majewski, M. Przybyszewski, W. Hołubowicz, "QoE assessment of VoIP over IEEE 802.16 networks with DaVinci codes using E-model", Future Network & Mobile Summit, Italy, June 2010
- [48] INFSCO-ICT-216203 DAVINCI D2.2.1 v1.0: Link level evaluation, Issue 1
- [49] Chaoming Song, Zehui Qu, Nicholas Blumm, and Albert-László Barabási “Limits of Predictability in Human Mobility” *Science* 19 February 2010: 327 (5968), 1018-1021. Lima, P.; Bonarini, A. & Mataric, M. (2004). *Application of Machine Learning*, InTech, ISBN 978-953-7619-34-3, Vienna, Austria

IntechOpen

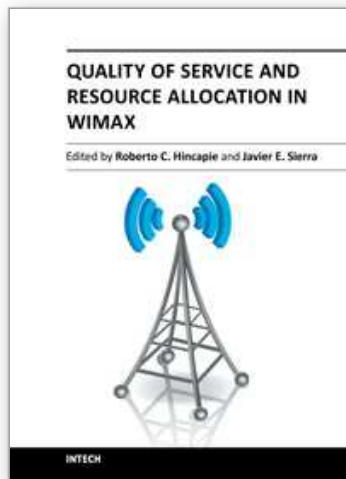

## **Quality of Service and Resource Allocation in WiMAX**

Edited by Dr. Roberto Hincapie

ISBN 978-953-307-956-1

Hard cover, 376 pages

**Publisher** InTech

**Published online** 03, February, 2012

**Published in print edition** February, 2012

This book has been prepared to present state of the art on WiMAX Technology. It has been constructed with the support of many researchers around the world, working on resource allocation, quality of service and WiMAX applications. Such many different works on WiMAX, show the great worldwide importance of WiMAX as a wireless broadband access technology. This book is intended for readers interested in resource allocation and quality of service in wireless environments, which is known to be a complex problem. All chapters include both theoretical and technical information, which provides an in depth review of the most recent advances in the field for engineers and researchers, and other readers interested in WiMAX.

### **How to reference**

In order to correctly reference this scholarly work, feel free to copy and paste the following:

Adam Flizikowski, Marcin Przybyszewski Mateusz Majewski and Witold Hołubowicz (2012). Evaluation of QoS and QoE in Mobile WIMAX – Systematic Approach, Quality of Service and Resource Allocation in WiMAX, Dr. Roberto Hincapie (Ed.), ISBN: 978-953-307-956-1, InTech, Available from:

<http://www.intechopen.com/books/quality-of-service-and-resource-allocation-in-wimax/evaluation-of-qos-and-qoe-in-mobile-wimax-systematic-approach>

**INTECH**  
open science | open minds

### **InTech Europe**

University Campus STeP Ri  
Slavka Krautzeka 83/A  
51000 Rijeka, Croatia  
Phone: +385 (51) 770 447  
Fax: +385 (51) 686 166  
[www.intechopen.com](http://www.intechopen.com)

### **InTech China**

Unit 405, Office Block, Hotel Equatorial Shanghai  
No.65, Yan An Road (West), Shanghai, 200040, China  
中国上海市延安西路65号上海国际贵都大饭店办公楼405单元  
Phone: +86-21-62489820  
Fax: +86-21-62489821

© 2012 The Author(s). Licensee IntechOpen. This is an open access article distributed under the terms of the [Creative Commons Attribution 3.0 License](#), which permits unrestricted use, distribution, and reproduction in any medium, provided the original work is properly cited.

IntechOpen

IntechOpen