

We are IntechOpen, the world's leading publisher of Open Access books Built by scientists, for scientists

5,300

Open access books available

130,000

International authors and editors

155M

Downloads

Our authors are among the

154

Countries delivered to

TOP 1%

most cited scientists

12.2%

Contributors from top 500 universities



WEB OF SCIENCE™

Selection of our books indexed in the Book Citation Index
in Web of Science™ Core Collection (BKCI)

Interested in publishing with us?
Contact book.department@intechopen.com

Numbers displayed above are based on latest data collected.
For more information visit www.intechopen.com



A Fuzzy Logic Approach for Remote Healthcare Monitoring by Learning and Recognizing Human Activities of Daily Living

Hamid Medjahed¹, Dan Istrate¹, Jérôme Boudy²,
Jean Louis Baldinger², Lamine Bougueroua¹,
Mohamed Achraf Dhouib¹ and Bernadette Dorizzi²

¹ESIGETEL-LRIT, Avon,

²Telecom SudParis, Evry,
France

1. Introduction

Improvement of life quality in the developed nations has systematically generated an increase in the life expectancy. A statistic studies carried out by the French national institute of statistic and economic studies (INSEE) shows a new distribution of age classes in France. In fact, almost one in three people will be over 60 years in 2050, against one in five in 2005, and France will have over 10 million of people over 75 years and over 4 million of people over 85 years. Nevertheless, the increasing number of elderly person implies more resources for aftercare, paramedical care and natural assistance in their habitats. The current healthcare infrastructure in those countries is widely considered to be inadequate to meet the needs of this increasingly older population. In this case a permanent assistance is necessary wherever they are, healthcare monitoring is a solution to deal with this problem and ensure the elderly to live safely and independently in their own home for as long as possible.

In order to improve the quality of life of elderly, researchers are developing technologies to enhance a resident's safety and monitor health conditions using sensors and other devices. Numerous projects are carried out in the world especially in Europe, Asia and North America on the home healthcare telemonitoring topic. They aim for example to define a generic architecture for such telemonitoring systems (Doermann et al., 1998), to conduct experiment of a remote monitoring system on a specific category of patients, like people with insufficient cardiac heart, asthma, diabets, patients with Alzheimer's disease, or cognitive impairments (Noury et al., 2003)., or to build smart apartments (Elger et al., 1998), sensors and alarm systems adapted to the healthcare telemonitoring requirements (West et al., 2005). The project CompanionAble is an Integration Project founded by European commission (FP7). In this project we propose a multimodal platform for recognizing human activities of daily living (ADLs) in the home environment, by using a set of sensors in order to provide proactive healthcare telemonitoring for elderly people at home. This platform uses a fuzzy logic approach to fuse three main subsystems, which have been technically

validated from end to end, through their hardware and software. The first subsystem is Anason (Rougui et al., 2009) with its set of microphones that allow sound remote monitoring of the acoustical environment of the elderly. The second subsystem is RFpat (Medjahed et al., 2008), a wearable device fixed on the elderly person, which can measure physiological data (cardiac frequency, activity or agitation, posture and fall detection sensor). The last subsystem is a set of infrared sensors and domotic sensors like contact sensors, temperature sensors, smoke sensors and several other domotic sensors for environment conditions monitoring (Medjahed et al., 2008). This fuzzy logic approach allowed us to recognize several activities of daily living (ADLs) for ubiquitous healthcare. The decision of this multimodal data fusion platform is sent to a remote monitoring center to take action in the case of distress situation.

2. CompanionAble project

The CompanionAble project aim to provide the synergy of Robotics and Ambient Intelligence technologies and their semantic integration to provide for a care-giver's assistive environment. This will support the cognitive stimulation and therapy management of the care-recipient. This is mediated by a robotic companion (mobile facilitation) working collaboratively with a smart home environment (stationary facilitation).

There are widely acknowledged imperatives for helping the elderly live at home (semi)-independently for as long as possible. Without cognitive stimulation support the elderly dementia and depression sufferers can deteriorate rapidly and the carers will face a more demanding task. Both groups are increasingly at the risk of social exclusion.

The distinguishing advantages of the CompanionAble Framework Architecture arise from the objective of graceful, scalable and cost-effective integration. Thus CompanionAble addresses the issues of social inclusion and homecare of persons suffering from chronic cognitive disabilities prevalent among the increasing European older population. A participative and inclusive co-design and scenario validation approach will drive the RTD efforts in CompanionAble; involving care recipients and their close carers as well as the wider stakeholders. This is to ensure end-to-end systemic viability, flexibility, modularity and affordability as well as a focus on overall care support governance and integration with quality of experience issues such as dignity-privacy-security preserving responsibilities fully considered.

CompanionAble will be evaluated at a number of testbeds representing a diverse European user-base as the proving ground for its socio-technical-ethical validation. The collaboration of leading gerontologists, specialist elderly care institutions, industrial and academic RTD partners, including a strong cognitive robotics and smart-house capability makes for an excellent confluence of expertise for this innovative project.

Everyday life activities in the home split into two categories. Some activities show the motion of the human body and its structure. Examples are walking, running, standing up, setting down, laying and exercising. These activities may be mostly recognized by using sensors that are placed on the body (Lee et al., 2002). A second class of activities is recognized by identifying or looking for patterns in how people move things. In this work we focus on some activities identification belong to these both categories.

3.1 Data fusion

In order to maximize a correct recognition of the various ADLs like sleeping, cleaning, bathing etc..., data fusion over the different sensors types is studied. The area of data fusion has generated great interest among researchers in several science disciplines and engineering domains. We have identified two major classes of fusion techniques:

- Those that are based on probabilistic models such as Bayesian reasoning (Cowell et al., 1999) and the geometric decision reasoning like Mahalanobis distance, but their performances are limited when the data are heterogeneous and insufficient for a correct statistical modeling of classes.
- Those based on connectionist models such as neural networks MLP (Dreyfus et al., 2002) and SVM (Burges et al., 1998) which are very powerful because they can model the strong nonlinearity of data but with complex architecture.

Based on those facts the use of fuzzy logic in our platform is motivated by two main reasons from a global point of view:

- Firstly the characteristic of data to merge which are measurements obtained from different sensors, thus they could be imprecise and imperfect. Plus the lack of training sets that reflect activities of daily living.
- Secondly, Fuzzy logic can gather performance and intelligibility and it deals with imprecision and uncertainty. Its history proves that it is used in many cases which are necessary for pattern recognition applications. It has a background application history to clinical problems including use in automated diagnosis (Adlassnig et al., 1986), control systems (Mason et al., 1997), image processing (Lalande et al., 1997) and pattern recognition (Zahlmann et al., 1997). For medical experts it is easier to map their knowledge onto fuzzy relationships than to manipulate complex probabilistic tools.

3.2 Fuzzy logic and patterns recognition systems

Fuzzy logic is a fuzzy set theory, introduced by Lotfi A. Zadeh (Zadeh, 1978) in 1965; it is an extension of classical set theory. Historically, this was closely related to the concept of fuzzy measure, proposed just after by Sugeno (Sugeno, 1974). Similar attempts at proposing fuzzy concept were also made at the same time by Shafer (evidence theory (Shafer, 1974)) and Shackle (surprise theory (Shackle, 1961)). Since that time, fuzzy logic has been more studied, and several applications were developed, essentially in Japan. The use of fuzzy sets can be done mainly at two levels:

- **Attributes representation:** It may happen that data are uncompleted or noisy, unreliable, or some attributes are difficult to measure accurately or difficult to quantify numerically. At that time, it is natural to use fuzzy sets to describe the value of these parameters. The attributes are linguistic variables, whose values are built with adjectives and adverbs of language: large, small, medium etc...and as an illustrating example, we found the recognition system proposed by Mandal et al. (Mandal et al., 1992). Some methods are based on a discretization of the attributes space defined as language. Thus a numerical scale of length will be replaced by a set of fuzzy labels, for example (very small, small, medium, large, extra large), and any measure of length, even numerical is converted on this scale. The underlying idea is to work with the maximal granularity, i.e. the minimal accuracy.

- **Class representation:** Groups do not create a clear partition of the data space, but a fuzzy partition where recovery is allowed will be better adapted. A significant number of fuzzy patterns recognition methods, are just an extension of traditional methods based on the idea of fuzzy partition for example the fuzzy c-means algorithm (Pedrycz, 1990). Historically, the idea of fuzzy partition was first proposed by Ruspini in 1969 (Ruspini, 1969).

Rather than creating new methods of fusion and patterns recognition based on entirely different approaches, fuzzy logic fits naturally in the expression of the problem of classification, and tend to make a generalization of the classification methods that already exist. Taking into account the four steps of a recognition system proposed by Bezdek et al (Bezdek et al., 1992), fuzzy logic is very useful for these steps.

- **Data description:** Fuzzy logic is used to describe syntactic data (Mizumoto et al., 1972), numerical and contextual data, conceptual or rules based data (Pao et al., 1989) which is the most significant contribution for the data description.
- **Analysis of discriminate parameters:** In image processing, there are many techniques based on fuzzy logic for segmentation, detection, contrast enhancement (Keller et al 1992) and extraction (Pal et al., 1986).
- **Clustering algorithms:** The aim of these algorithms is to label a set of data into C groups, so that obtained groups contain the most possible similar individuals. Fuzzy c-mean algorithm and fuzzy ISODATA (Dunn, 1973) algorithm are the better known in this category.
- **Design of the discriminator:** The discriminator is designed to produce a fuzzy partition or a clear one, describing the data. This partition corresponds to a set of classes. Indeed the fuzzy ISODATA algorithm is adapted for this step.

3.3 Fuzzy logic steps

We concentrate our efforts in emphasizing the fuzzy logic concept in order to integrate this fundamental approach within the telemonitoring platform. The main concept of fuzzy logic is that many problems in the real world are imprecise rather than exact (Buckley et al., 2002). It is believed that the effectiveness of the human brain is not only from precise cognition, but also from fuzzy concepts, fuzzy judgment, and fuzzy reasoning. An advantage of fuzzy classification techniques lies in the fact that they provide a soft decision, a value that describes the degree to which a pattern fits within a class, rather than only a hard decision, i.e., a pattern matches a class or not. Fuzzy logic is based on natural language which makes it quite attracting field in artificial intelligence. It allows the natural description of problem domains, in linguistic terms, rather than in terms of relationships between precise numerical values.

A fuzzy set, as the foundation of fuzzy logic, is a set without a hard, clearly sharp defined boundary. A fuzzy set extends a standard set by allowing degrees of membership of an element to this set, measured by real numbers in the $[0;1]$ interval. If X is the universe of discourse (the input space variable) and its elements are denoted by x , then a fuzzy set A on X is defined as a set of ordered pairs $(x, \mu_A(x))$ such that:

$$A = \{x, \mu_A(x) / x, 0 \leq \mu_A(x) \leq 1 \} \quad (1)$$

Where $\mu_A(x)$ in equation (1), is the membership function (MF) of each x in A . In contrast to classical logic where the membership function $\mu_A(x)$ of an element x belonging to a set A could take only two values: $\mu_A(x) = 1$ if $x \in A$ or $\mu_A(x) = 0$ if $x \notin A$, fuzzy logic introduces the concept of membership degree of an element x to a set A and $\mu_A(x) \in [0;1]$, here we speak about the truth value.

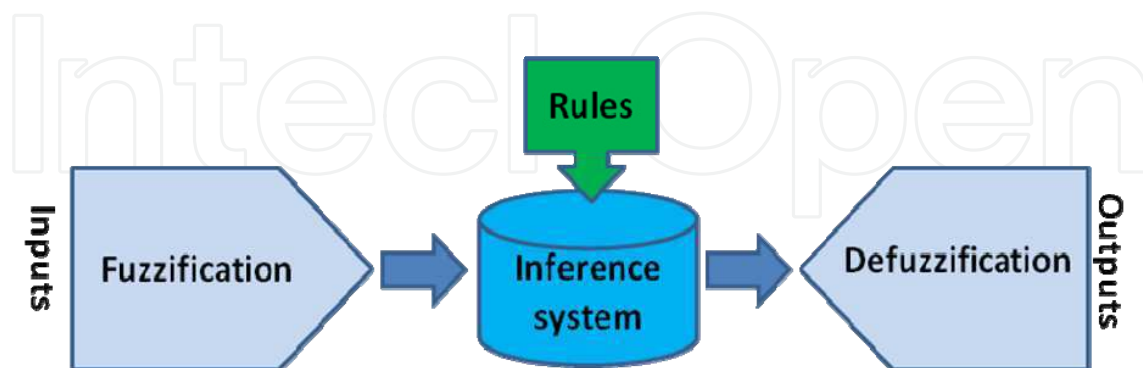

Fig. 1. Fuzzy inference system steps.

A typical fuzzy logic inference system has four components: the fuzzification, the fuzzy rule base plus the inference engine, and the defuzzification. Figure 1 shows those main fuzzy inference system steps.

3.3.1 Fuzzification

First step in fuzzy logic is to convert the measured data into a set of fuzzy variables. It is done by giving value (these will be our variables) to each of a membership functions set. Membership functions take different shape. A Triangular membership function with straight lines can formally be defined as follows:

$$\Lambda(x, a, b, c) = \begin{cases} 0, & x \leq a \\ (x - a) / (b - a), & a \leq x \leq b \\ (c - x) / (c - b), & b \leq x \leq c \\ 0, & x \geq c \end{cases} \quad (2)$$

Trapezoidal function furnished in the equation (3).

$$f(x, a, b, c, d) = \begin{cases} 0, & x \leq a \\ (x - a) / (b - a), & a \leq x \leq b \\ 1, & b \leq x \leq c \\ (d - x) / (d - c), & c \leq x \leq d \\ 0, & x \geq d \end{cases} \quad (3)$$

A Gaussian membership function with the parameters m and σ to control the center and width of the function is defined by:

$$G(x, m, \sigma) = e^{-\frac{(x-m)^2}{2\sigma^2}} \quad (4)$$

The generalized Bell function depends on three parameters a, b, and c is given by:

$$f(x, a, b, c) = \frac{1}{1 + \left\| \frac{(x-c)}{a} \right\|^{2b}} \quad (5)$$

There are also other memberships functions like sigmoid shaped function, single function etc... The choice of the function shape is iteratively determined, according to the type of data and taking into account the experimental results.

3.3.2 Fuzzy rules and inference system

The fuzzy inference system uses fuzzy equivalents of logical AND, OR and NOT operations to build up fuzzy logic rules. An inference engine operates on rules that are structured in an IF-THEN format. The IF part of the rule is called the antecedent, while the THEN part of the rule is called the consequent. Rules are constructed from linguistic variables. These variables take on the fuzzy values or fuzzy terms that are represented as words and modeled as fuzzy subsets of an appropriate domain. There are several types of fuzzy rules, we only mention the two mains used in our system:

- **Mamdani rules** (Jang et al., 1997) : which are on the form: *If x_1 is A_1 and x_2 is A_2 and...and x_p is A_p Then y_1 is C_1 and y_2 is C_2 and...and y_p is C_p* Where A_i and C_i are fuzzy sets that define the partition space. The conclusion of a Mamdani rule is a fuzzy set. It uses the algebraic product and the maximum as T-norm and S-norm respectively, but there are many variations by using other operators.
- **Takagi/Sugeno rules** (Jang et al., 1997): those rules are on the form : *If x_1 is A_1 and x_2 is A_2 and...and x_p is A_p Then $y = b_0 + b_1 x_1 + b_2 x_2 + \dots + b_p x_p$.* In the Sugeno model the conclusion is numerical. The rules aggregation is in fact the weighted sum of rules outputs.

3.3.3 Defuzzification

The last step of a fuzzy logic system consists in turning the fuzzy variables generated by the fuzzy logic rules into real values again which can then be used to perform some action. There are different defuzzification methods; in our platform decision module we could use Centroid Of Area (COA), Bisector Of Area (BOA), Mean Of Maximum (MOM), Smallest Of Maximum (SOM) and Largest Of Maximum (LOM). Equations 6, 7, 8 and 9 illustrate them.

$$Z_{COA} = \frac{\sum_{i=1}^n \mu_A(x_i) x_i}{\sum_{i=1}^n \mu_A(x_i)} \quad (6)$$

$$Z_{BOA} = x_M; \sum_{i=1}^M \mu_A(x_i) = \sum_{j=M+1}^n \mu_A(x_j) \quad (7)$$

$$Z_{MOM} = \frac{\sum_{i=1}^N x_i^*}{N} \quad (8)$$

$$Z_{SOM} = \min(x_i^*) \text{ and } Z_{LOM} = \max(x_i^*) \quad (9)$$

Where $x_i^* (i = 1, 2, \dots, N)$ reach the maximal values of $\mu_A(x)$

4. The multimodal telemonitoring platform

We define a smart environment as one with the ability to adapt the environment to the inhabitants and meet the goals of comfort and efficiency. In order to achieve these goals, our first aim is focused on providing such an environment. We consider our system as an intelligent agent, which perceives the state of the environment using sensors and acts consequently using device controllers.

4.1 Sound environment analysis (Anason)

In-home healthcare devices face a real problem of acceptance by end users and also caregivers. Sound sensors are easily accepted by care receivers and their family, they are considered less intrusive than cameras, smart T-shirts, etc. In order to preserve the care-receiver privacy while ensuring his protection and safety, we propose to equip his house with some microphones. In this context, the sound signal flow is continuously analyzed but not continuously recorded. Among different everyday life sounds, only some of them are considered alarming sounds: glass breaking, screams, etc. In order to have a reliable sound telemonitoring system, every sound event is detected (a sudden change in the environmental noise), extracted, and used as input for the classification stage. The sound analysis system has been divided in three modules as shown in Figure 2.

The first module (M.1) is applied to each channel or microphone in order to detect sound events and to extract them from the signal flow. This module uses an algorithm based on energy of discrete wavelet transform (DWT) coefficients, which was proposed and evaluated in (Rougui et al., 2009). This algorithm detects precisely the signal beginning and its end, using properties of wavelet transform.

The second module (M.2) is a low-stage classification one. It processes the sound received from the first module (M.1) in order to separate the speech signals from the sound ones. The method used by this module is based on Gaussian Mixture Model (GMM) [14] (K-means followed by Expectation Maximization in 20 steps). There are other possibilities for signal classification: Hidden Markov Model (HMM), Bayesian method, etc. Even if similar results have been obtained with other methods, their high complexity and high time consumption prevent from real-time implementation. A preliminary step before signal classification is the extraction of acoustic parameters: LFCC (Linear Frequency Cepstral Coefficients) 24 filters. The choice of this type of parameters relies on their properties: bank of filters with constant bandwidth, which leads to equal resolution at high frequencies often encountered in life sounds. The best performances have been obtained with 24 Gaussians.

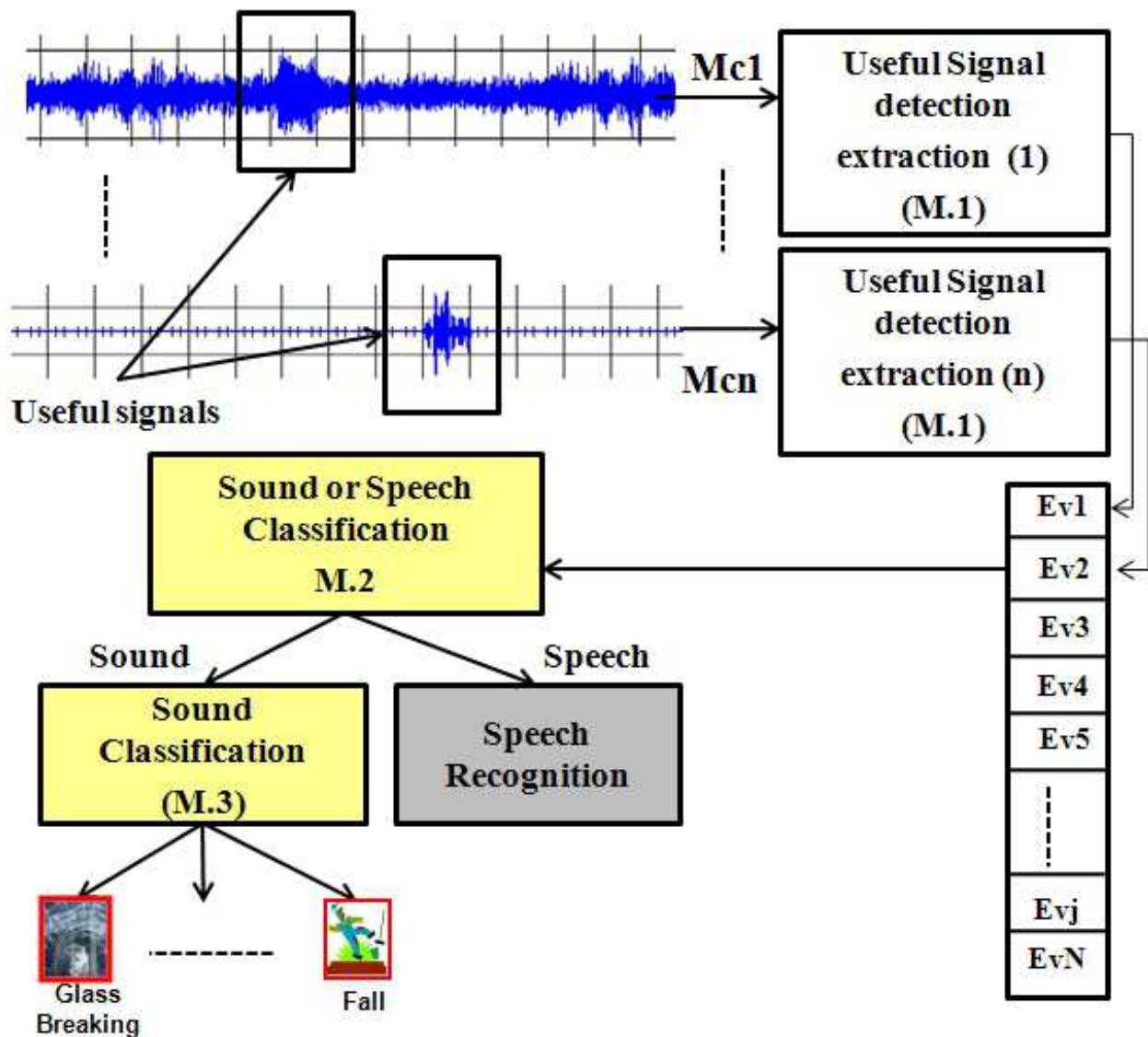

Fig. 2. Anason software architecture

The sound classification module (M.3) classifies the detected sound between predefined sound classes. This module is based, also, on a GMM algorithm. The LFCC acoustical parameters have been used for the same reasons than for sound/speech module and with the same composition: 24 filters. A loglikelihood is computed for the unknown signal according to each predefined sound classes; the sound class with the biggest log likelihood is the output of this module.

4.2 Vital signals wearable device (RFpat)

The wearable device named RFpat (Hoppenot et al., 2009), designed by Telecom SudParis and integrated by ASICA, is devoted to the surveillance of the vital status of the care receiver, transmitting a fall index after validation by an embedded algorithm. Further functionalities of the wearable device include the eventual use of the emergency call button, the determination of the heart pulse rate (beat/minute) and of a posture index, a movement frequency index and a technical status of the device.

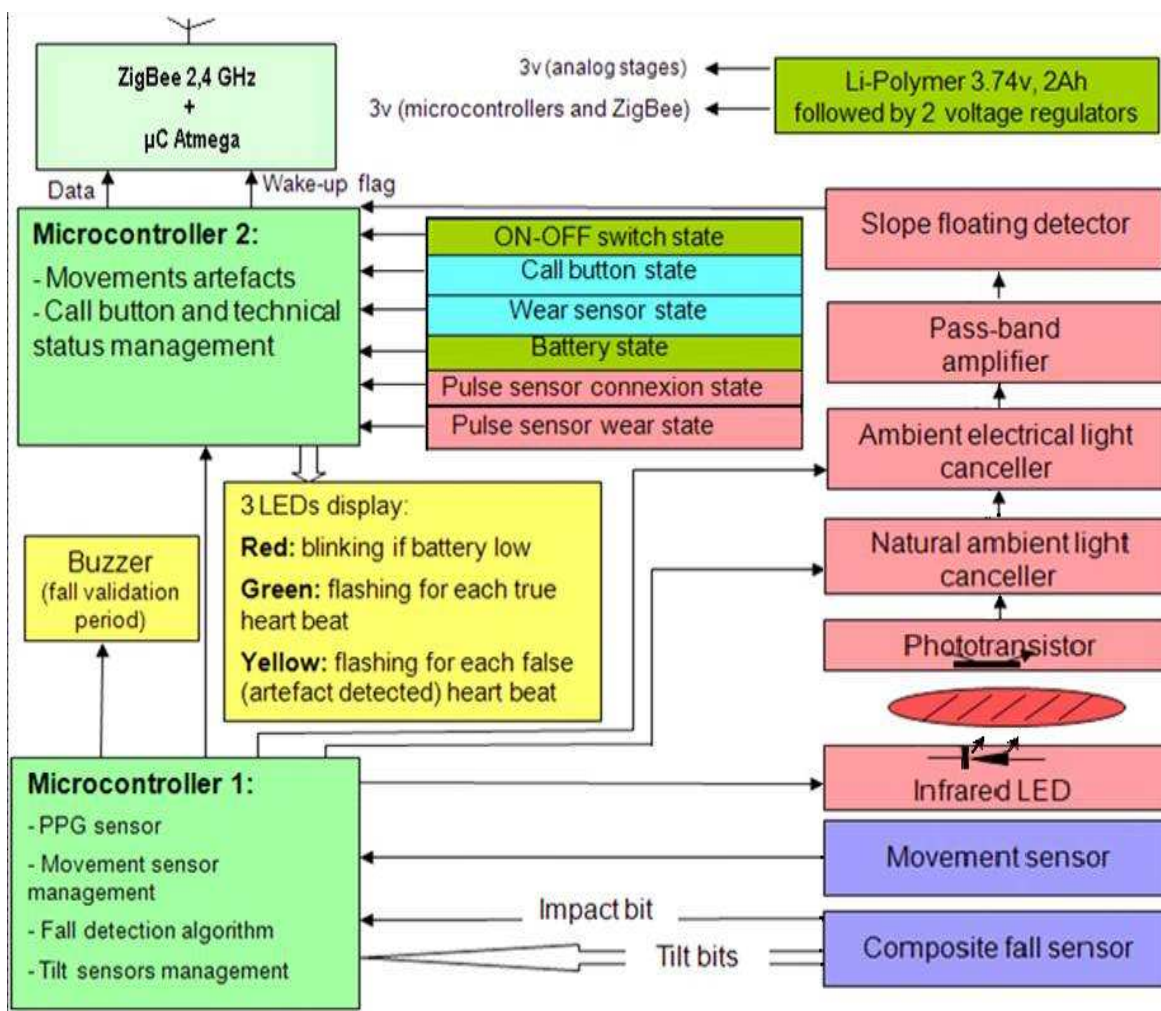

Fig. 3. Internal structure of the wearable device (RFpat)

In a case of emergency situation, for example if the care receiver has fallen down without standing up, with an eventual short delay, afterwards or has pushed the call button, the wearable device will transmit via ZigBee communication the corresponding alarm index to an in-home base station, which is connected to the multimodal platform. If no emergency event occurs, data are transmitted to this receiver every 30 seconds. In case of wireless link interruption, the data will be stored into an internal flash memory of the ZigBee transceiver and pushed through this ZigBee link when recovered.

The device use two microcontrollers (Figure 3), the first is processing "actimetric" sensors i.e. fall, movement and tilt sensor and driving analog switches used for the sampling process of the PPG signal pre-conditioner, the second being devoted to the processing of the pulse sensor. The ZigBee transceiver is also driven by the second microcontroller. All the circuits are supplied by a Lithium-Polymer battery element of 3.7 volts followed by 2 voltage regulators providing a voltage of 3 volts, one for the digital circuits and the ZigBee module, the second being used to supply the analog circuits.

The vital signals terminal is planned as a mobile device worn by the person of care in the smart home environment as well as in the short range outside environment (garden etc.).

The mobile device is connected to the base station with a ZigBee network. The simple version of the network is working with two nodes. One node is defined as the coordinator, which is the base station on the central smart home control PC. The other node is defined as one end device, which is normally the wearable device. In poor RF conditions another node defined as a routing device that can extend the range between the base station and the wearable device. We have chosen the ZigBee IEEE 802.15.4 protocol because it is a secure and common protocol in the smart home environment. The most important advantages are the good power management and a good indoor wireless range with added routers if needed, which was preferred to a high bandwidth (WiFi for instance). We normally transmit 3 bytes every 30 seconds.

4.3 Home automation sensors

The in-home healthcare monitoring systems have to solve an important issue of privacy. When developing our multi-modal platform, we chose the monitoring modules such that they have the less intrusive incidence on the monitored elderly person. We equipped our test apartment with wireless infrared sensors connected to a remote computer. The computer automatically receives and saves data obtained from the different sensors. Data corresponding to movements are collected twice per second, and stored with the event time in a specific file.

The sensors are activated by the person's passage underneath, and remained activated as long as there is movement under that sensor and for an additional time period of $\frac{1}{2}$ seconds after the movement end. The results from the automatic processing of this data are displayed in the form of list with all movements noted together with the time and each movement's duration. This subsystem called Gardien is also able to display the data either in the form of graph (activity duration versus days) or as three-dimensional histograms (each sensor activation versus time).

A set of wireless ambient sensors is added to this subsystem, they are designated for telemonitoring the environment of the patient and his surroundings. It includes state change sensors for active devices detection, contact sensors which are responsible for door and windows opening /closing detection, temperature sensors, fire sensors, flood sensors and light sensors.

5. Fuzzy logic activities recognition approach

5.1 Parameter and method elaboration

The main advantages of using fuzzy logic system are the simplicity of the approach and the capacity of dealing with the complex data acquired from the different sensors. Fuzzy set theory offers a convenient way to do all possible combinations with these sensors. Fuzzy set theory is used in this system to monitor and to recognize the activities of people within the environment in order to timely provide support for safety, comfort, and convenience. Automatic health monitoring is predominantly composed of location and activity information. Abnormality also could be indicated by the lack of an activity or an abnormal activity detection which will cause or raise the home anxiety. Table 1 lists what we wish to automatically recognize.

ADLs of using devices	ADLs of Human body motion
getting up, toilet, bathing, going out of home, enter home, washing dishes, doing laundry, washing hands, watching TV, listening radio, cleaning talking on telephone, cooking	sleeping, walking, standing up setting down, laying exercising

Table 1. Fuzzy List ADLS to be recognized by the telemonitoring platform

The first step for developing this approach is the Fuzzification of system outputs and inputs obtained from each sensor and subsystem.

From Anason subsystem three inputs are built. The first one is the sound environment classification, all detected sound class and expressions are labeled on a numerical scale according to their source. Nine membership functions are set up in this numerical scale according to sound sources as it is in table 2.

Membership Function	Composition
Human Sound	snoring, yawn, sneezing, cough, cry, scream, laugh
Speech	key words and expressions
Multimedia Sounds	TV, radio, computer, music
Door sounds	door clapping, door knob, key ring
Water sounds	water flushing, water in washbasin, coffee filter
Ring tone	telephone ring, bell door, alarm, alarm clock
Object sound	chair, table, tear-turn paper, step foot
Machine sounds	coffee machine, dishwasher, electrical shaver, microwave, vacuum cleaner, washing machine, air conditioner
Dishwasher	glass vs glass, glass wood, plastic vs plastic, plastic vs wood, spoon vs table

Table 2. Fuzzy sets defined for the ANASON classification input

Two other inputs are associated to each SNR calculated on each microphone (two microphones are used in the current application), and these inputs are split into three fuzzy levels: low, medium and high.

The wearable terminal RFpat produce five inputs; Heart rate for which three fuzzy levels are specified normal, low and high; Activity which has four fuzzy sets: immobile, rest, normal and agitation; Posture is represented by two membership functions standing up / sitting down and lying; Fall and call have also two fuzzy levels: Fall/Call and No Fall/Call.

The defined area of each membership function associated to heart rate or activity is adapted to each monitored elderly person. In our application we use only posture, and activity inputs.

For each infrared sensor C_i a counter of motion detection with three fuzzy levels (low, medium, high) is associated, and a global one for all infrared sensors.

The time input has five membership functions morning, noon, afternoon, evening and night which are also adapted to patient habits.

For each main machine in the house a change state sensor S device's name is associated. It has two membership functions turn on and turn off. One debit sensor for water is included in our application. Three membership functions characterize this sensor, low, medium and high. The output of our fuzzy logic ADL recognition contains some activities which are selected from the table I. They are Sleeping (S), Getting up (GU), Toileting (T), Bathing (B), Washing hands (WH), Washing dishes (WD), Doing laundry (DL), Cleaning (CL), Going out of home (GO), Enter home (EH), Walking (W), Standing up (SU), Setting down (SD), Laying (L), Resting (R), Watching TV (WT) and Talking on telephone (TT). These membership functions are ordered, firstly according to the area where they maybe occur and secondly according to the degree of similarity between them.

The next step of our fuzzy logic approach is the fuzzy inference engine which is formulated by a set of fuzzy IF-THEN rules. This second stage uses domain expert knowledge regarding activities to produce a confidence in the occurrence of an activity. Rules allow the recognition of common performances of an activity, as well as the ability to model special cases. An example fuzzy rule for alarm detection is:

If (Anason is Machine sound) and (Activity is motion) and ($C_{Overall}$ is high) and (C_B is high) and (C_5 is high) and (S_{vacuum} is turn on) Then (ADLs is Cleaning).

A confidence factor is accorded to each rule and in order to aggregate these rules we have the choice between Mamdani or Sugeno approaches available under our fuzzy logic component. After rules aggregation the Defuzzification is performed by the centroid of area for the ADLs output.

5.2 Software implementation

Figure 4 provides a synoptic block-diagram scheme of the software architecture of the ADL recognition platform; it is implemented under LabwindowsCVI and C++ software. It is developed in a form of design component. We can distinguish three main components, the acquisition module, the synchronization module and the fuzzy inference component.

It can run off-line by reading data from a data base or online by processing in real time data acquired via the acquisition module. To avoid the loss of data, a real time module with two multithreading tasks is integrated in the synchronization component. The platform is now synchronized on Gardien subsystem because of his smallest sampling rate (2 Hz) and periodicity. Indeed in some situations the RFpat system may be not used by the elderly person, namely if no recommendations relative to its cardiac watch or a particular risk of fall are given by the Doctor.

The telemonitoring system with its Fuzzy tools allows the easy configuration of input intervals of fuzzification, the writing of fuzzy rules and the configuration of the defuzzification method. The general interface of the system allows to build up membership functions of inputs and outputs and displaying them. We could also write rules on text file

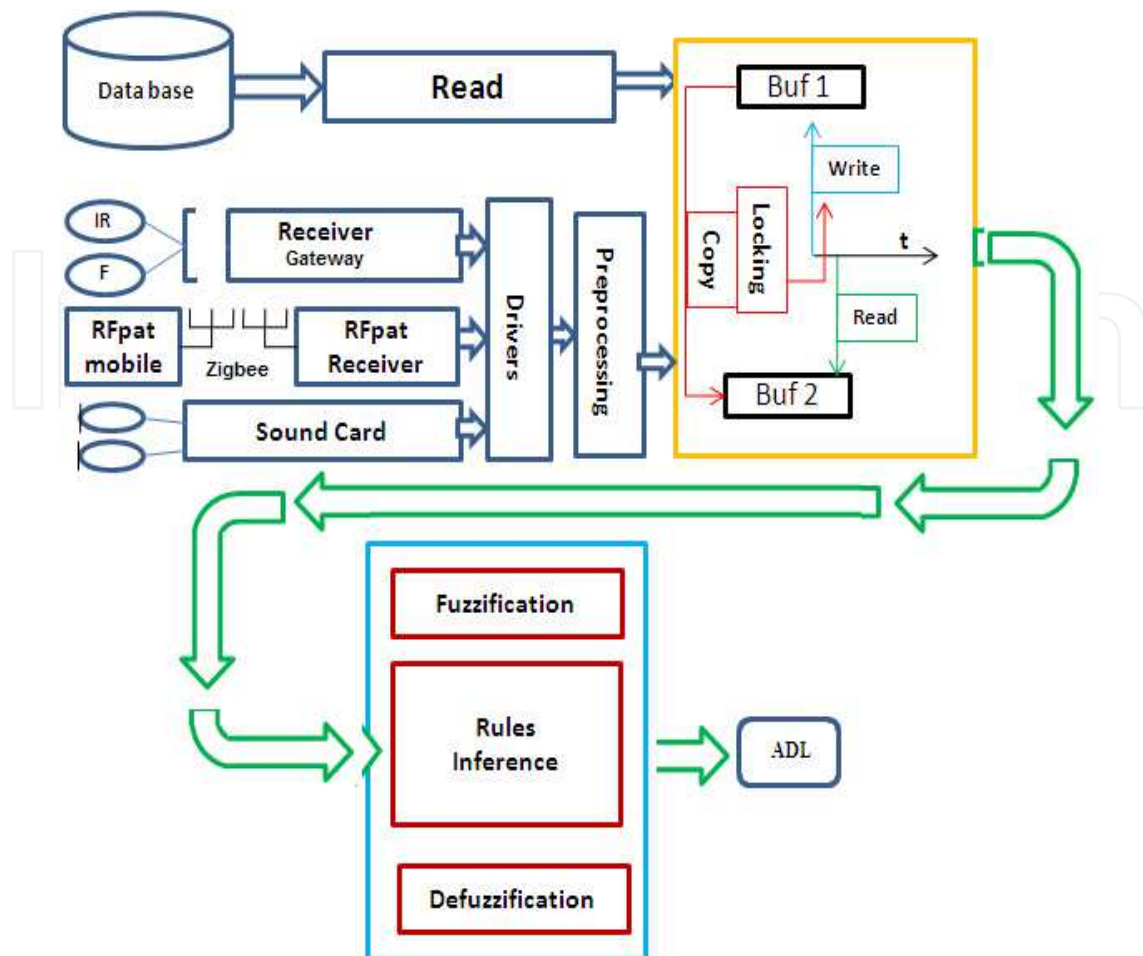

Fig. 4. software implementation design

by using a specific language, understandable by the telemonitoring system. This framework also allows for rules to be added, deleted, or modified to fit each particular resident based on knowledge about their typical daily activities, physical status, cognitive status, and age. The software implementation is validated with many experimental tests. The results and the rules which produced them are displayed on the main panel.

6. DSS integration system

The decision of this multimodal data fusion platform is sent to a real time decision integration system. This integration is performed by a multi-agent system (MAS) in which each agent coordinates separately with a decision support systems (DSS). The pertinence of each DSS is determined by the occurrence of false and undetected alarms.

The agent delegates the decisional task to its corresponding DSS. The out coming decisions' data are then formatted by the agent in an abstract decision report. This report format is recognized in the whole system and enables a central agent to make the final decision. A real-time negotiation of the decisions is able to improve the usage of appropriate resources within an acceptable response time. Thus, this multi-agent system architecture enables these DSS to have uniform view of the decision concept and to exchanges both knowledge and

intelligence, even if they implement several decisional techniques (Neural networks, fuzzy logic). In a remote healthcare monitoring system, we need such a solution in order to understand the behavior of the patient and the state of its domicile. Then, we can make the system evolve according to the analyzed behavior.

6.1 Decision abstraction and priority assignation

In intelligent remote healthcare monitoring, a decision support system uses the data flow of several modalities to generate decisions about the patient's situation. To standardize the decision concept, we classify the generated decisions by the modalities used. The considered modalities in our system are: sound, speech, physiological data (e.g. activeness and pulse rate), actimetric data (localization, falls), video, sensor states and alarm calls. Generally, every decision is based on global pertinence calculated by combining the pertinence affected to each decision modality. For a d decision, the global pertinence is:

$$Gp(d) = \sum_{m_i} p_i(d) \cdot c_i \quad (10)$$

Where: m_i is the modalities used for the decision d , p_i is the pertinence of the decision d according to the modality m_i , c_i is the coefficient of the modality m_i accorded by the DSS.

When a DSS generates a decision, it sends the data concerning this decision to its encapsulating agent. The agent reorganizes these data in a decision report (type, pertinence, arrival date ...), which it then sends to the central agent.

The collective decision is made in two phases:

- Phase 1: the central agent starts the wait window of phase-1. The duration of the wait window depends on the trigger decision data (agent affinity, modalities used ...). In this paper, we do not detail the computing algorithm of the waiting duration. The decision messages received in phase-1 are called SEND decisions. A SEND decision is a spontaneous decision. It is not a response to a previous request. In the case of a trigger decision, we also define the pertinence threshold. The arriving decision reports during this first wait window are fused with the trigger decision. If the final decision's pertinence surpasses the threshold, the decision is confirmed as an alert. If the wait window is terminated without attaining the pertinence threshold, the central agent starts the second phase of decision.
- Phase 2: the central agent starts a new wait window. During this wait window, a real-time consensus is launched among the agents concerned by the trigger decision modalities. For this purpose, the central agent assigns to each concerned agent a consensus priority. This is computed as follows:

$$p_i(d) = \sum_{m_j \in d} A_{ij} \cdot c_j \quad (11)$$

Where m_j is the modalities used in the trigger decision d , c_j is the corresponding coefficient for each modality, A_{ij} is the affinity of the agent i for the modality m_j .

During this second wait window, the received message may be SEND decisions. As they do not concern the launched consensus, they are placed in the wait queue. The response messages are called CALL BACK decisions. At the end of the second wait window, the central agent computes the global pertinence of the received CALL BACK decisions. If the pertinence threshold is reached, the trigger decision is confirmed otherwise it is rejected and a learning procedure is sent to the responsible agent. In this article, we do not detail the inner learning procedure of such an agent.

6.2 Real-time scheduling of the collective decision process

One of the major problems in the field of multi-agent systems is the need for methods and tools that facilitate the development of systems of this kind. In fact, the acceptance of multi-agent system development methods in industry depends on the existence of the necessary tools to support the analysis, design and implementation of agent-based software. The emergence of useful real-time artificial intelligence systems makes the multi-agent system especially appropriate for development in a real-time environment (Julian and Botti, 2004). Furthermore, the response time of the DSS in a remote healthcare monitoring system is a central issue. Unfortunately the DSS studied in this context does not give a real-time response. For this reason we aim to control, as much as possible, the response time of their encapsulating Agents. The Gaia role model we presented in section 3 guaranties that the agent encapsulation of a DSS makes its response time transparent to the other agents.

6.2.1 General operating principle

This work has focused on a time-critical environment in which the acting systems can be monitored by intelligent agents which require real-time communication in order to better achieve the system's goal, which is detecting, as fast as possible, the distress situation of the patient. The works of (Julian and Botti, 2004) define a real-time agent as an agent with temporal restrictions in some of its responsibilities or tasks. According to this same work, a real-time multi-agent system is one where at least one of its agents is a real-time agent. The central agent is the unique decision output of our system. We will apply these definitions by focusing on the real-time scheduling of the central agent tasks. Firstly the different tasks of this agent must be defined. Subsequently, diverse scenarios and the priority assignation rules may be defined.

As explained previously, the central agent receives all the decision reports in the system. The first main issue is thus the scheduling of the treatment of these messages. For each decision received the central agent chooses the concerned agents and assigns a response deadline to each one, based on the degree of expertise of the concerned agent in the modalities used. We propose a scheduling model that enables the reaching of a consensus between the different concerned agents while respecting the defined response deadlines.

6.2.2 Definition of the central agent tasks

As described in figure 6, an agent has two main functions: conative and cognitive. In the case of the central agent, the cognitive function consists of communicating with the other agents. The conative function consists of making final decisions.

This classification leads us to this list of tasks assigned to the central agent:

- Cognitive tasks:
 - Message reception: connection establishing and stream reading.
 - Message classification: according to the type of the request, this task classifies each message in the appropriate wait queue.
 - Entities representation: this task comes into play at each collective decision cycle. Its role is to keep the state of the other agents in the central agent memory, as well as that of the central agent itself.
 - Message send : connection establishing and stream writing
- Conative tasks:
 - Request analysis and execution: this task executes the selected message requests. Generally it triggers another task of the central agent (representation, message send, decision)
 - Decision: this task maintains a fusion buffer in which the message execution task puts the decision message. When this task is activated, it adds all the un-executed messages in the highest priority wait queue to the fusion buffer.
 - Deadline assignation: this task assigns an absolute deadline to each message before classification
 - Message selection: this task selects the message to be executed from the message buffer.
 - Phase manager: this task is responsible for the transition between the collective decision phases. It comes into operation when a wait window is closed or when a collective decision is made. Its main role is changing the priority of central agent tasks.

Each task is executed according to the automaton described in figure 6.

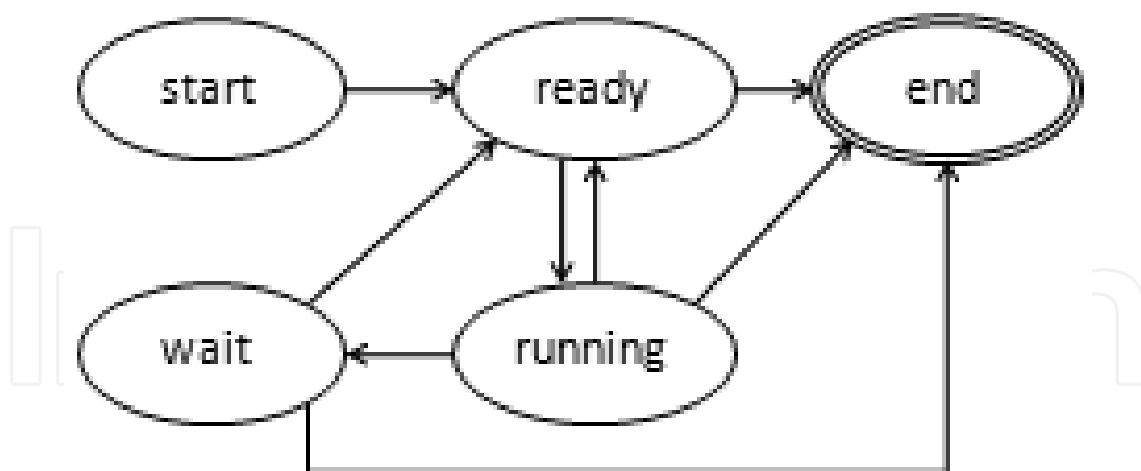

Fig. 6. Execution states of the central agent tasks.

6.2.3 Message classification

The central agent message buffer consists of 3 different wait queues (WQ): the CALL BACK queue, for the CALL BACK decision messages, the SEND queue, for the SEND decision message and the Best Effort queue, for the other communication messages (decisions, service requests ...)

The BE queue is FIFO scheduled (First In First Out). There is no deadline or priority consideration in this queue. The CALL BACK and the SEND queue are EDF scheduled (George et al., 1996). EDF is the preemptive version of Earliest Deadline First non idling scheduling. EDF schedules the tasks according to their absolute deadlines: the task with the shortest absolute deadline has the highest priority.

Each message deadline must be determined before being classified in a wait queue. For this reason the Deadline assignment task, the message classification task and the message reception task must be fused. In fact, when a message arrives, the message reception task is activated. It cannot then be preempted before assigning the message to its corresponding wait queue.

6.2.4 Queue priority and message selection

The message queues have dynamic priorities. This priority is assigned by a phase manager task. In phase-1, the SEND queue has the highest priority. In phase-2, the CALL BACK queue has the highest priority. While the message buffer is not empty, the message execution task's state is *Ready*. When it passes to execution, it selects the shortest deadline message from the highest priority queue. During the wait window of phase-1, the received SEND must be executed first. Thus we assign the highest priority to the SEND queue. When this wait window is closed, the decision task gets the highest priority. The CALL BACK queue has the highest priority in phase-2. Thus a phase cannot be terminated until the corresponding wait queue is empty and all the received decisions fused.

6.2.5 Global scheduling of the central agent

The main scheduling algorithm of the central agent is FP/HPF. FP/HPF denotes the preemptive Fixed Priority Highest Priority First algorithm with an arbitrary priority assignment (Lehoczky, 1990).

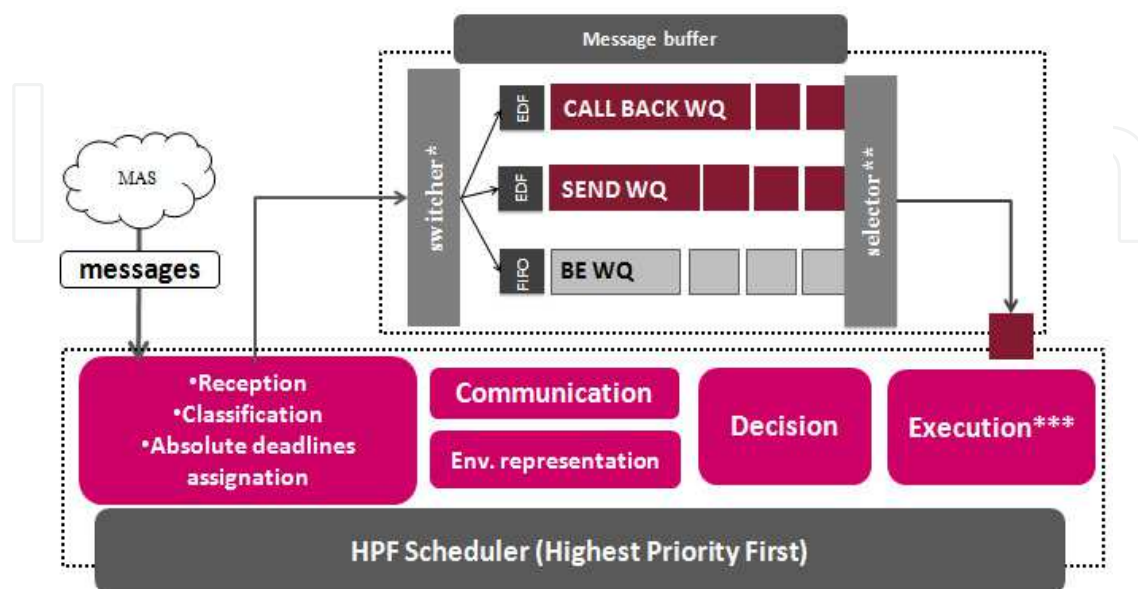

Fig. 7. Real-time scheduling of the central agent.

In table 2, we present the priority evolution of each task during the different steps of the 2-phase collective decision (the higher the number, the higher the priority). The phase manager task always has the highest priority. In fact, it is responsible for changing the system phase and the priority assignation.

6.2.6 Scheduling sample

In figure 8, we present a scheduling sample in a system composed of a central agent (CA) and five other agents (A1, A2, A3, A4, A5). The red arrows represent the movement of the task to the ready state. Here we present the priority assigned to each task at the beginning of each phase. We suppose that the message wait queues are initially empty.

Task	Wait For trigger	Phase-1		Phase-2	
		wait	Decision	wait	Decision
reception	4	4	2	3	1
Send	1	1	3	4	3
decision	2	2	4	1	4
execution	3	3	1	2	2
phase manager	5	5	5	5	5

Table 3. Priority variation of the central agent tasks

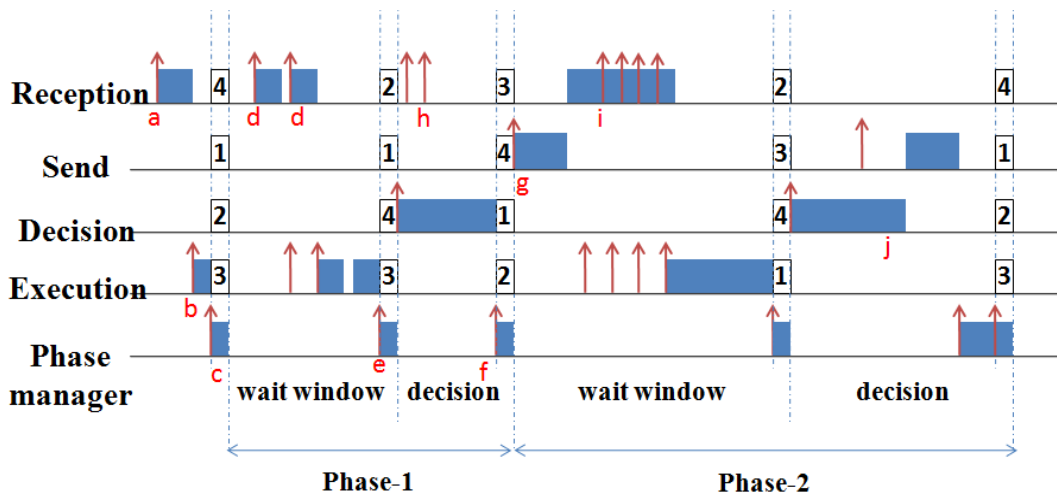

Fig. 8. Temporal diagram of a scheduling sample

Our sample scenario goes through these stages: a trigger decision from A3 is received. The execution task treats the received trigger and then requests that the phase manager start a new collective decision process. The phase manager starts the first phase. It opens a new wait window and changes the priority of the CA tasks. During phase-1, two SEND decisions are received (from A1 and A4). The first wait window is terminated by the phase manager task.

The highest priority is assigned to the decision task. The pertinence threshold is not reached. The phase manager task starts the second phase. The highest priority in this task is accorded to the send task in order to allow the CA to activate the consensus.

During the phase-1 decision process, the CA receives two SEND messages. The reception task is preempted because it has a lower priority. In phase-2, A1, A2, A4 and A5 are involved in the consensus (a choice based on the trigger decision modalities). A SEND and 3 CALL BACK decisions are received (positive: A1 and A5, negative: A4). The final fusion reaches the pertinence threshold. Two learning procedures are sent to A4 and A2. We suppose that the message buffer is initially empty.

The phase manager task is responsible for changing the priority of the central Agent tasks. We can observe on figure 8 the priority assigned to each task at the start of each new phase. The task manager is activated at the end of the wait windows to hand over to the decision task. At the end of its treatment, the decision task hands back to the phase manager task which starts a new phase by changing the priority of the other tasks.

7. Experimentation and results

The proposed method was experimentally achieved on a simulated data in order to demonstrate its effectiveness. This simulation gives very promising results for the ADLs recognition. Figure 9 shows results for a stream of a data. This fist study was devoted to the evaluation of the system by taking into account rules used in this fuzzy inference system.

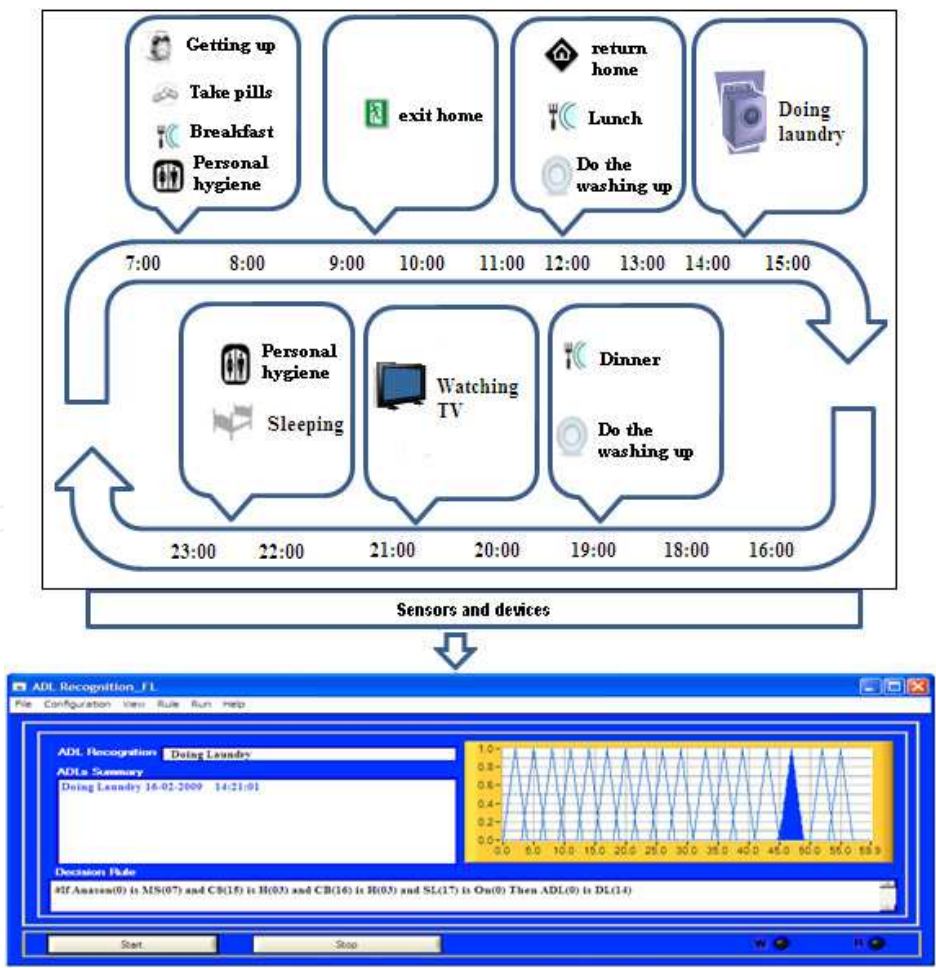

Fig. 9. ADLs recognition experiment for a stream data.

The used strategy consisted in realizing several tests with different combination rules, and based on obtained results one rule is added to the selected set of rules in order to get the missed detection. With this strategy good results are reached for the ADL output (about 97% of good ADL detection).

The experimentation described here is preliminary but demonstrates that ubiquitous, simple sensor devices can be used to recognize activities of daily living from real homes. The system can be easily retrofitted in existing home environments with no major modifications or damage.

8. Conclusion

In this chapter we have explore the cutting-edge research and technologies in monitoring daily activities using a set of sensors deployed in the house. The objective of the research is to provide a feasible solution for improving care for elderly people, while significantly reducing the healthcare cost. Focusing on the open problem of multiple persons monitoring, we have used an optimal set of sensors, design an algorithm for ADL recognition based on fuzzy logic, and implement a prototype. This approach provides robust and high accuracy recognition rate. Assisting elderly persons in place will benefit from the results of this research. The next objective of this research is to use these identification activities for building a model for measuring the home anxiety, that increases or decreases according to the detection activity and the state of each device in the home.

9. Acknowledgments

This work is supported by the European Commission in the frame of the Seventh Framework Program (FP7/2007-2011) within the CompanionAble Project (grant agreement n. 216487).

10. References

- Adlassnig K. P., Fuzzy set theory in medical diagnosis, *IEEE Tr. On Syst.,Man, and Cybernetics*, March/April 1986,pp. 260–265.
- Bezdek J. C. & Pal S. K., “Fuzzy Models for Pattern Recognition,” IEEE Press, 1992.
- Buckley,J.J , Eslami E, An introduction to fuzzy logic and fuzzy sets. *Advances in Soft Computing*. Physica-Verlag, Germany, 2002.
- Burges C. J. C., A tutorial on SVM for Pattern Recognition. *Data Mining and Knowledge Discovery*, volume 2, 1998, pp. 121–167.
- Cowell R., Dawid A., Lauritzen S. & Spiegelhalter D., *Probabilistic Networks and Expert Systems*, 1999, ISBN : 0-387-98767-3.
- Doermann D. and Mihalcik D., A system approach to achieving carernet, an integrated and intelligent telecare system, *IEEE Trans Biomed Eng*, 2:1-9, 1998.
- Dreyfus G., Martinez J.M, Samuelides M., Gordon M., Badran F., Thiria S. & Hrault L., *Réseaux de neurones. Méthodologie et applications*, Eyrolles, 2002.
- Dunn J.C., A fuzzy relative of the isodata process and its use in detecting compact well-separated clusters. *IEEE Tran. on Systems, Man, and Cybernetics*, pp. 32–57, 1973.

- Elger G. & Furugren B., "smartbo", an ICT and computer-based demonstration home for disabled people, in Proc. of the 3rd TIDE Congress : Technology for Inclusive Design and Equality Improving the Quality of Life for the European Citizen, Helsinki, Finland, 1998.
- George, L., Rivierre, N., Spuri, M.: Preemptive and non-preemptive real-time uniprocessor scheduling". INRIA, research Report 2966, Sept. 1996.
- Hoppenot P., Boudy J., Delarue S., Baldinger J.-L. , Colle E., "Assistance to the maintenance in residence of handicapped or old people JESA - Volume 43 - N° 3/2009 pp. 315 - 335.
- Jang J.S.R., Sun C. T. & Mizutani E., Neuro-Fuzzy and Soft Computing :A Computational Approach to Learning and Machine Intelligence. Prentice Hall Upper Saddle River, NJ 1997.
- Julian V., Botti V., Developing real-time multi-agent systems. Integr. Comput.-Aided Eng. vol. 11,n° 2, p. 135-149, Amsterdam, April 2004.
- Keller J.M. & Krishnapuram R., "Fuzzy set methods in computer vision," In R.R. Yager and L.A. Zadeh, editors, An Introduction to Fuzzy logic Applications in Intelligent Systems Kluwer Academic, pp. 121-145, 1992.
- Lalande A., Legrand L., Walker P. M., Jaulent M. C., Guy F., Cottin Y. & Brunotte F., Automatic detection of cardiac contours on MR images using fuzzy logic and dynamic programming, Proc. AMIA Ann. Fall Symp. 1997, pp. 474-478.
- Lee S.W & Mase K., "Activity and location recognition using wearable sensors," IEEE Pervasive Computing, 1(3):2432, 2002.
- Lehoczky J.P., Fixed priority scheduling of periodic task sets with arbitrary deadlines. Proc. 11th IEEE Real-Time Systems Symposium, FL, USA, pp. 201-209, 5-7 Dec. 1990.
- Mandal D.P., Murthy C. A. & Pal S. K., "Formulation of a multivalued recognition system," IEEE Transactions on Systems, Man, and Cybernetics, 22:607-620 1992.
- Mason D., Linkens D. & Edwards N., Self-learning fuzzy logic control in medicine, Proc. AIME'97, (E. Keravnou et al., eds.), Lecture Notes in Artificial Intelligence 1211, Springer-Verlag, Berlin 1997, pp. 300-303.
- Medjahed H., Istrate D., Boudy J., Steenkeste F., Baldinger J.L., Belfeki I., Martins V. & Dorizzi B. , A Multimodal Platform for Database Recording and Elderly People Monitoring, BIOSIGNALS 2008, Jan 2008, Funchal-Madeira, Portugal, pp.385-392.
- Mizumoto M., Toyoda J. & Tanaka K., "General formulation of formal grammars," Info Sci., 4:87-100, 1972.
- Noury N., Barralon P., Virone G., Boissy P., Hamel M. & Rumeau P., A smart sensor based on rules and its evaluation in daily routines, in Proc of the IEEE-EMBC, pages 3286-3289, Cancun, Mexico, September 2003.
- Pal S.K. & Chakraborty B., "Fuzzy set theoretic measure for automatic feature evaluation," IEEE Transactions on Systems, Man, and Cybernetics, 16:754-760, 1986.
- Pao Y. H., "Adaptive Pattern Recognition and Neural Networks," Addison-Wesley, 1989.
- Pedrycz W., "Fuzzy sets in pattern recognition: methodology and methods," Pattern Recognition, 23(1/2):121-146, 1990.
- Rougui J.E., Istrate D. & Souidene W., Audio Sound Event Identification for distress situations and context awareness, EMBC2009, September 2-6, Minneapolis, USA, 2009, pp. 3501-3504.
- Ruspini E. H., "A new approach to clustering," Inform, Control, 15(1):22-32, 1969.
- Shackle G.L., "Decision, Order and Time in Human Affairs," Cambridge Univ. Press

Shafer G., "A Mathematical Theory of Evidence," Princeton Univ. Press 1979.

Sugeno M., Theory of fuzzy integrals and its applications. Doct. Thesis, Tokyo IT 1974.

West G.A.W., Greenhill S. & Venkatesh S., A probabilistic approach to the anxious home for activity monitoring. in Proc. 29th Annual International Computer Software and Applications Conference: COMPSAC, pages 335-340, Edinburgh, Scotland 2005.

Zadeh L.A., Fuzzy sets as a basis for theory of possibility, Fuzzy Set Systems. pp. 3-28, 1978.

Zahlmann G., Scherf M. & Wegner A., A neurofuzzy classifier for a knowledge-based glaucoma monitor, Proc. AIME'97, (E. Keravnou et al., eds.), Lecture Notes in Artificial Intelligence 1211, Springer-Verlag, Berlin 1997, pp. 273-284.

IntechOpen

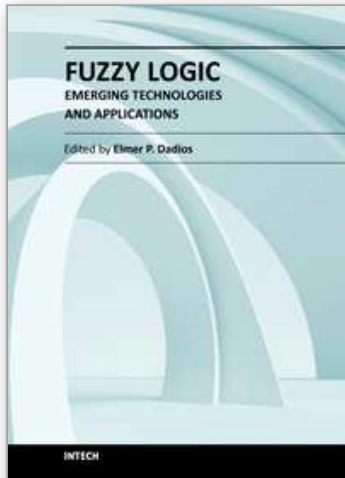

Fuzzy Logic - Emerging Technologies and Applications

Edited by Prof. Elmer Dadios

ISBN 978-953-51-0337-0

Hard cover, 348 pages

Publisher InTech

Published online 16, March, 2012

Published in print edition March, 2012

The capability of Fuzzy Logic in the development of emerging technologies is introduced in this book. The book consists of sixteen chapters showing various applications in the field of Bioinformatics, Health, Security, Communications, Transportations, Financial Management, Energy and Environment Systems. This book is a major reference source for all those concerned with applied intelligent systems. The intended readers are researchers, engineers, medical practitioners, and graduate students interested in fuzzy logic systems.

How to reference

In order to correctly reference this scholarly work, feel free to copy and paste the following:

Hamid Medjahed, Dan Istrate, Jérôme Boudy, Jean Louis Baldinger, Lamine Bougueroua, Mohamed Achraf Dhouib and Bernadette Dorizzi (2012). A Fuzzy Logic Approach for Remote Healthcare Monitoring by Learning and Recognizing Human Activities of Daily Living, *Fuzzy Logic - Emerging Technologies and Applications*, Prof. Elmer Dadios (Ed.), ISBN: 978-953-51-0337-0, InTech, Available from:

<http://www.intechopen.com/books/fuzzy-logic-emerging-technologies-and-applications/a-fuzzy-logic-approach-for-remote-healthcare-monitoring-by-learning-and-recognizing-human-activities>

INTECH

open science | open minds

InTech Europe

University Campus STeP Ri
Slavka Krautzeka 83/A
51000 Rijeka, Croatia
Phone: +385 (51) 770 447
Fax: +385 (51) 686 166
www.intechopen.com

InTech China

Unit 405, Office Block, Hotel Equatorial Shanghai
No.65, Yan An Road (West), Shanghai, 200040, China
中国上海市延安西路65号上海国际贵都大饭店办公楼405单元
Phone: +86-21-62489820
Fax: +86-21-62489821

© 2012 The Author(s). Licensee IntechOpen. This is an open access article distributed under the terms of the [Creative Commons Attribution 3.0 License](#), which permits unrestricted use, distribution, and reproduction in any medium, provided the original work is properly cited.

IntechOpen

IntechOpen