

# We are IntechOpen, the world's leading publisher of Open Access books Built by scientists, for scientists

5,300

Open access books available

130,000

International authors and editors

155M

Downloads

Our authors are among the

154

Countries delivered to

TOP 1%

most cited scientists

12.2%

Contributors from top 500 universities



WEB OF SCIENCE™

Selection of our books indexed in the Book Citation Index  
in Web of Science™ Core Collection (BKCI)

Interested in publishing with us?  
Contact [book.department@intechopen.com](mailto:book.department@intechopen.com)

Numbers displayed above are based on latest data collected.  
For more information visit [www.intechopen.com](http://www.intechopen.com)



# Optical Absorption Spectroscopy for Quality Assessment of Extra Virgin Olive Oil

Anna Grazia Mignani<sup>1</sup>, Leonardo Ciaccheri<sup>1\*</sup>,  
Andrea Azelio Mencaglia<sup>1</sup> and Antonio Cimato<sup>2</sup>

<sup>1</sup>CNR – Istituto di Fisica Applicata “Nello Carrara”

<sup>2</sup>CNR – Istituto per la Valorizzazione del Legno e delle Specie Arboree  
Italy

## 1. Introduction

Light travels through space in the form of electromagnetic waves of different wavelengths. The entire wavelength range represents the electromagnetic spectrum. Spectroscopy studies the interaction between light and matter, in order to draw information about the chemical composition inside (Lee et al., 2011). Figure 1 shows the various bands of the electromagnetic spectrum. This chapter refers to measurements performed in the 200-2500 nm band, which is usually subdivided into three portions: the ultraviolet (UV), the visible (VIS) – perceivable by human eyes – and the near-infrared (NIR). They correspond to the 200-400 nm, 400-780 nm, and 780-2500 nm ranges, respectively.

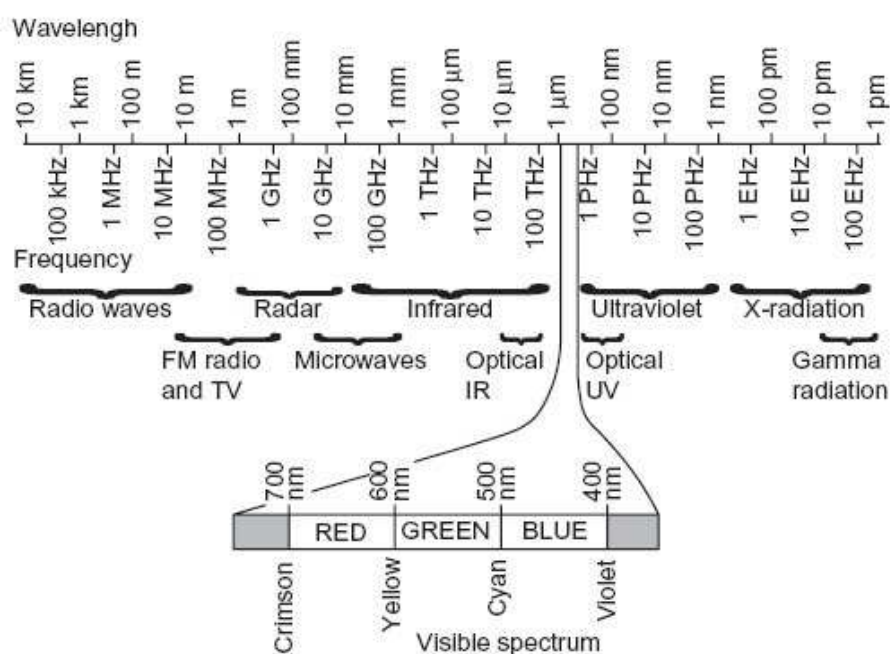

Fig. 1. The electromagnetic spectrum

\* Corresponding Author

A light beam illuminating an olive oil sample gives rise to reflected, transmitted, and scattered intensities. Optical absorption spectroscopy, as shown in Figure 2, makes use of a broadband UV-VIS-NIR source of intensity  $I_0$  to illuminate the olive oil sample. Then, the transmitted light intensity  $I$ , as a function of the illumination wavelength is measured. The change in light intensity, providing the transmittance  $T$ , is determined by the molar absorptivity  $\varepsilon$ , the concentration of absorbing species  $C$ , and the optical path  $L$ , via the Lambert-Beer relationship, expressed by Equations 1 and 2.  $T$  is frequently expressed logarithmically as in Equation 3, to give the so called optical absorbance  $A$ , which results linearly dependent on concentration.

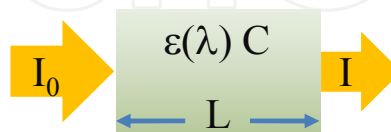

Fig. 2. Optical absorption spectroscopy: the working principle

$$I = I_0 \exp(-\varepsilon C L) \quad (1)$$

$$T = \frac{I}{I_0} = \exp(-\varepsilon C L) \quad (2)$$

$$A = \log \frac{I_0}{I} = \varepsilon C L \quad (3)$$

This chapter focuses on extra virgin olive oil quality evaluation achieved by means of UV-VIS-NIR absorption spectroscopy. The composition of olive oil is about 98% triglycerides and approximately 2% non glycerid constituents.

- The UV spectrum involves the electronic absorption of fatty acids; in particular, the 230-270 nm band shows high absorption when conjugated dienes and trienes of unsaturated fatty acids are present. For this reason, the absorbances measured at 232 nm and 270 nm, namely  $K_{232}$  and  $K_{270}$ , provide an official method for olive oil quality control, which is capable of detecting product oxidation and adulteration by means of rectified oils. In addition, the 300-400 nm band provides information about polyphenols (Jiménez Márquez, 2003; Cerretani et al., 2005).
- The VIS spectrum reveals the presence of dyes and pigments (Wrolstad et al., 2005). A and B chlorophylls and their derivatives (pheophytins), carotenoids, and flavonoids such as anthocyanins present distinctive absorption bands in the VIS.
- The wide NIR range is informative for the molecular structure of fats, thanks to the presence of overtones and combinations of vibrational modes of C-H and O-H bonds (Osborne et al., 1993; Ozaki et al., 2007).

In practice, the entire UV-VIS-NIR absorption spectrum can be considered an optical signature, a sort of univocal *fingerprnt* of the olive oil. The spectroscopic data can be suitably processed for obtaining a correlation to quality indicators, to the geographic origin of production, to product authenticity as well as to adulteration detection.

## 2. Instrumentation

Absorption spectroscopy in the UV-VIS-NIR range is one of the most popular measuring methods of conventional analytic chemistry (Mellon, 1950; Bauman, 1962). The most relevant advantages offered are:

- direct measurement: little or no sample preparation is necessary; consequently, the analysis is simple, fast, and does not require manual intervention;
- non-destructive analysis by means of a small quantity of sample;
- compatibility for use in an industrial setting by means of compact instruments.

The conventional instrument for absorption spectroscopy is the double-beam spectrophotometer, the working principle of which is depicted in Figure 3. Since quartz-based optical fibers are transparent in the UV-VIS-NIR range, they are used to equip conventional spectrophotometers by flexible means. Indeed, optical fibers offer the unique possibility of localized probing, a particularly attractive feature for online measurements, which can be carried out in real time without any sample drawing. Moreover, the recent availability of bright LEDs and miniaturized spectrometers further enhances the intrinsic optical and mechanical characteristics of optical fibers and makes it possible to implement compact and moderate-cost instruments.

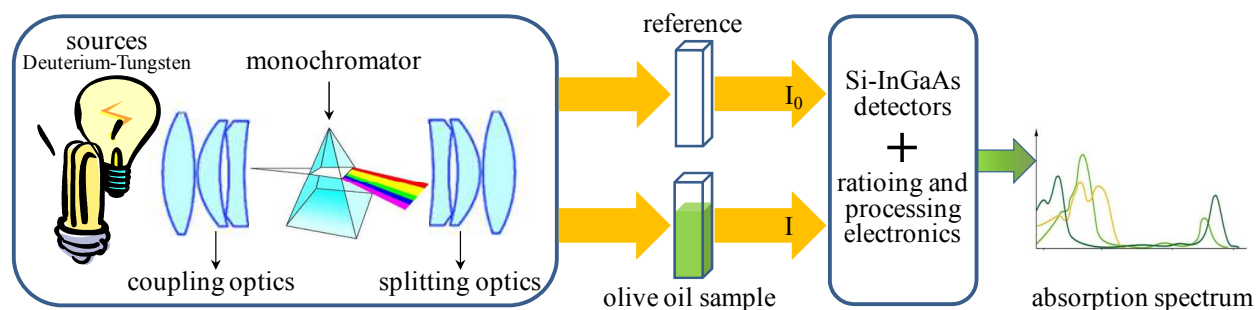

Fig. 3. Working principle of a double-beam spectrophotometer

The conventional spectrophotometer, implemented by means of optical fiber technology, is depicted in Figure 4. In this case, optical fibers are used for both illumination and detection,

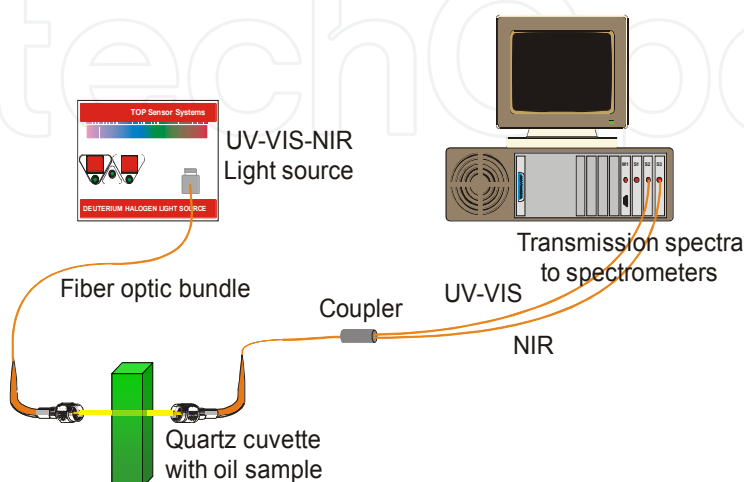

Fig. 4. Fiber optic setup for absorption spectroscopy

and a single cuvette is used. The reference spectrum is measured prior to sample analysis. While the optical fiber strand for illumination can be a single optical fiber or a bundle, the detection is necessarily carried out by means of a bifurcated bundle, or by a coupling device, so as to split the detected light intensity into two spectrometers, for the UV-VIS and the NIR spectroscopic range, respectively.

### 3. A touch of chemometrics

The chemical information given by an absorption spectrum is contained in the positions and intensities of the absorption bands. Whereas the band positions give information about the appearance and the structure of certain chemical compounds in a mixture, the intensities of the bands are related to the yield of these compounds. Since olive oil contains numerous compounds, the UV-VIS-NIR absorption spectrum shows broad peaks resulting from the convolution of the many overlapping bands, as summarized in Figure 5 (Osborne, 2000).

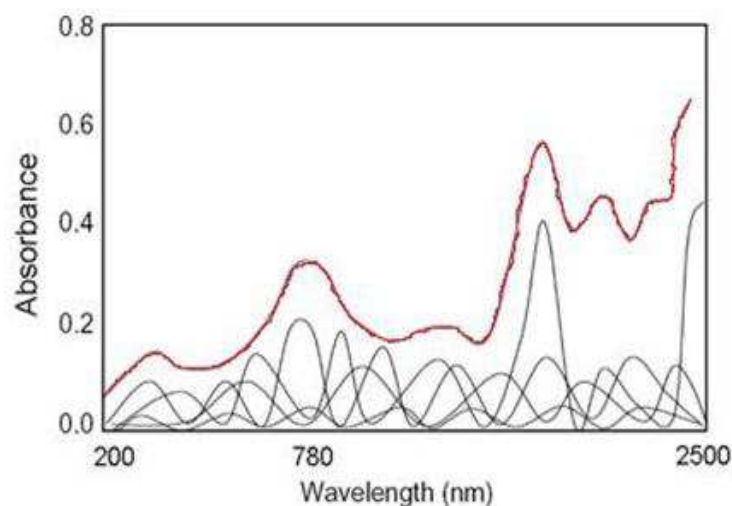

Fig. 5. Absorption spectrum – convolution of absorption spectra of many compounds in a mixture

For qualitative and quantitative analysis, the spectroscopic fingerprinting must be calibrated against reference analytical data from a database of samples representing the best variability in the population. Figure 6 summarizes the steps to follow for achieving a multicomponent analysis from absorption spectroscopy.

- What is needed is a library of representative spectra and relative analytical data to which the spectrum of a test sample may be matched.
- Firstly, a data dimensionality reduction is carried out, which usually leads to a scatter plot where samples are clustered according to the similarity of their spectra. This allows a preliminary inspection of data structure and the detection of what parameters are more likely to be correlated with spectroscopic data.
- Then a more specific analytical tool is chosen according to the type of variable that has to be predicted (quantitative or qualitative). A “Calibration Matrix” is created from which the constituent of interest may be calculated by means of a linear combination of spectroscopic data. The calibration equation has associated statistics which define the closeness of the actual and predicted values. A scatter plot is usually created to detect

any aberrant data. Ideally, the scatter plot should contain data points distributed evenly along a straight line with a narrow confidence limit.

- A validation procedure is then applied for testing the effectiveness of calibration method. While the data dimensionality reduction is usually capable of identifying similarities among products, the correlation to quality indicators always needs the further steps of calibration and validation.

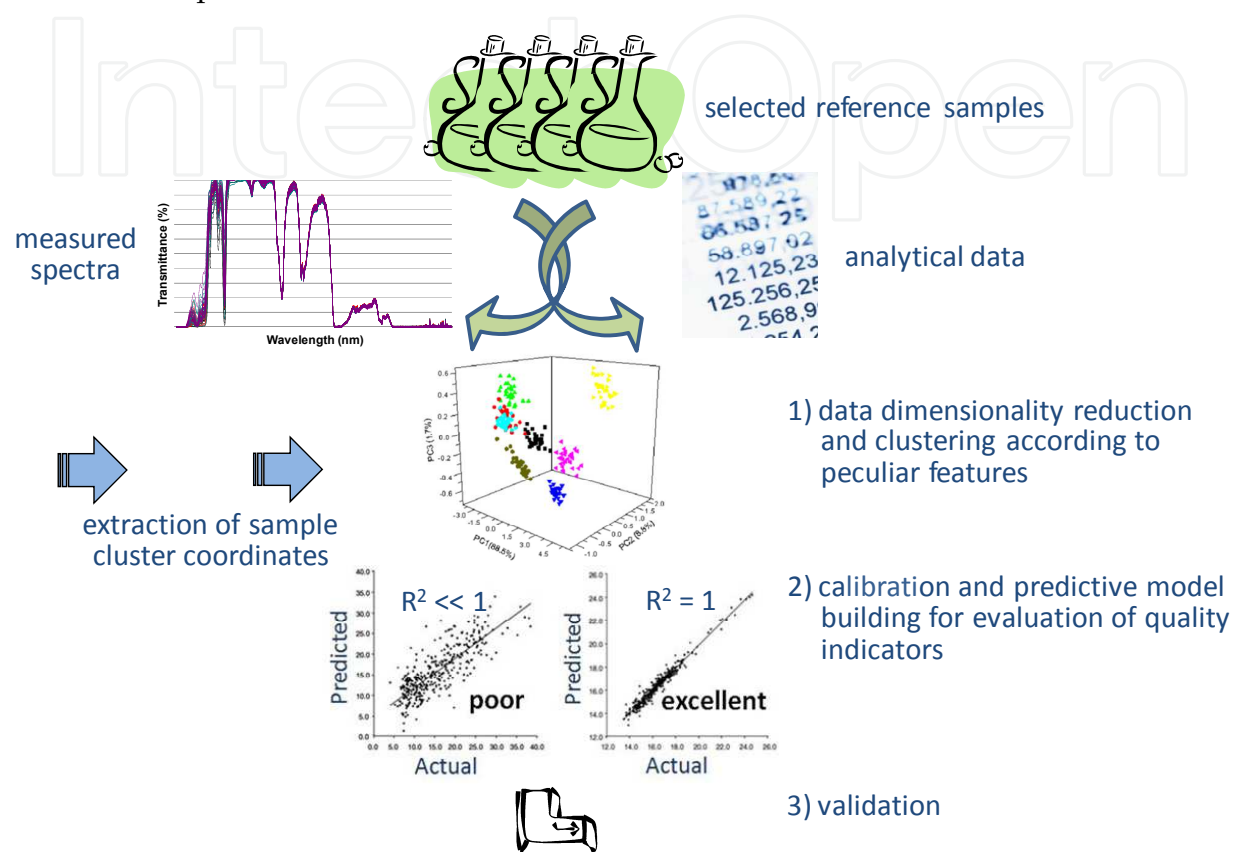

Fig. 6. Steps toward a multicomponent analysis by spectroscopy and chemometrics

Given the nature and complexity of the spectroscopic and analytical data sets involved, many multivariate chemometric techniques have been proposed (Ingle et al., 1988; Mark et al., 2007). The challenge of every multivariate data processing method is to provide excellent classification performance even when few training data are available. Indeed, smart data processing by means of chemometrics makes UV-VIS-NIR optical spectroscopy a rapid and non-destructive method for quality assessment of extra virgin olive oil.

One of the most popular techniques for explorative analysis, data dimensionality reduction, and clustering is the Principal Component Analysis (PCA) that provides the coordinates for identifying the samples in a 2D or 3D map (Jackson, 2003). It linearly combines the spectroscopic data characterizing each oil sample to produce new variables. The coefficients giving the weight of each variable in the linear combination are called *loadings*. The new variables are called Principal Components (PCs), and have the following properties:

- the PCs are mutually uncorrelated (orthogonality);
- the 1<sup>st</sup> PC (PC1) has the largest variance among all possible linear combination of the starting variables;



- the PC<sub>n</sub> has the largest variance among all linear combination of the starting variables that are orthogonal to PC<sub>1</sub> ... PC<sub>(n - 1)</sub>.

This means that high order PCs have little weight in characterizing the oil samples, and can be disregarded with little loss of information. The loading plots are useful to interpret the score map: they show what variables are important for a given PC. A variable with 0 loading has no importance, a variable with high (positive or negative) loading is important. If a PC has a positive or negative loading at a given wavelength, a sample having high absorbance at that wavelength will tend to have a positive or negative score along that PC.

PCA can also be used for prediction of categorical variables, that is classification, at least in those cases in which they are clearly distinguishable. However, when PCA does not provide satisfactory classification, a more dedicated multivariate data processing tool must be used, such as the Linear Discriminant Analysis (LDA). LDA is a powerful tool that provides both a reduction in dimensionality and automatic object classification. Like PCA, LDA projects a high-dimensional pattern onto a subspace of smaller dimension, but the axes for projection are chosen using a different criterion (Vandeginste et al., 1998).

From the point of view of discriminant analysis, PCA has a drawback: because it weighs the variables in terms of their variance, the features with good discriminating power but limited variance are disregarded. On the contrary, LDA is a tool that is specifically suited for identification, and looks for those variables that show a large spread among different clusters (inter-class variance), but limited variance within each cluster (intra-class variance). Given an N-class problem, the LDA extracts from the data matrix N-1 Discriminating Functions (DFs), which correspond to Principal Components in the PCA, but show a better resolution with regard to poorly-separated clusters. LDA is a *supervised* method. It needs a training set of already classified objects to estimate inter-class and intra-class variances. If all starting variables obey the Gaussian distribution, LDA also provides an easy way to classify unknown patterns. In this case, the points of each cluster in the DF space are distributed following the (N-1)-dimensional Gaussian density function. Thus, classification is achieved simply by evaluating the coordinates of a pattern in the DF space, and then by seeing which of the N density function is higher at that point.

One of the most popular techniques for the prediction of quantitative variables, such as the concentration of an analyte in a multicomponent mixture, is the Partial Least Squares regression (PLS) (Wold et al., 2001). This method is used when the predictor matrix has many collinear variables and the usual Multiple Linear Regression (MLR) cannot be applied. PLS looks for a limited number of PLS factors (PF) which are linear combinations of the original predictors. These new variables are mutually orthogonal (thus uncorrelated) and have the maximum possible covariance with the target variable, among all possible combinations of the original predictors. The idea is that each PF should be linked to a different source of data variance, with the first PF being the most linked to the target variable. The estimation of the optimal number of factors needed to fit the data is a critical issue of PLS. The optimal number of factors is usually assessed by testing each PLS model on the validation set and by minimizing the RMSEP (Root Mean Square Error of Prediction). There are two other fundamental parameters for assessing the goodness of the fit: the RMSEC (Root Mean Square Error of Calibration) and the determination coefficient ( $R^2$ ), respectively. RMSEC is, like RMSEP, an estimation of the expected prediction error, but is

evaluated on the calibration set. The closeness of RMSEC and RMSEP provides an estimation of robustness of the predictive model.  $R^2$  is, instead, the squared correlation coefficients between predicted and reference values, for the calibration set; thus the fit is as better as this value is closer to 1 ( $R^2 \leq 1$ ).

#### 4. Scattered colorimetry – Looking at olive oil as it is

The extra virgin olive oil is a blend of *cultivars* – different varieties of fruit species – which determine the blend's organoleptic properties. In addition to a distinctive taste, each oil blend has a distinctive color and turbidity. Color is mainly determined by the pigment content of the olives, and by the stage of ripening when they are harvested, whereas turbidity is mainly related to the mill type. Moreover, some commercial oils are filtered before bottling, while other oils are bottled unfiltered to provide a natural appearance. Anyway, both color and turbidity provide a means for oil assessment, and standard techniques are used for their independent measurement.

- Color: the intensity of a white-light source crossing the liquid is measured by a spectrometer, giving the transmission spectrum. The chromaticity coordinates  $L^*$ ,  $a^*$ , and  $b^*$  of the CIE1976 Chromaticity Diagram, are then computed (Figure 7, top-left) (Billmeyer et al., 1981; Hunt, 1987).
- Turbidity: the intensities of the monochromatic light crossing the liquid along its axis and scattered at  $90^\circ$  are measured. The ratio between the two is the turbidity in nephelometric turbidity units (Figure 7, top-right) (ISO 7027, 1999).

These color and turbidity measurement methods are popular because of their generality, simplicity, and applicability. In the case of color, since the definition of color is independent of the substance, the method can be applied to any liquid. In the case of turbidity, the independence of the test material is attained by reference to an ISO standard turbid material.

However, both methods view the characteristics separately, i.e., the color method never considers the liquid's turbidity, while the turbidity method never considers the color. Usually, in order to avoid mutual interferences, the olive oil is filtered prior to color measurements, while turbidity measurements are performed at a color-independent wavelength – typically at 830 nm. In order to evaluate the olive oil sample as it is, a new technique combining color and turbidity measurements was proposed, which was called scattered colorimetry or spectral nephelometry, since it extended the color and turbidity standards by adding light sources and observation angles, as shown in Figure 7-bottom (Mignani et al., 2003).

Scattered colorimetry makes use of four white light sources, which span the 450-630 nm spectroscopic range, and a miniaturized optical fiber spectrometer as detector. The sources, positioned at different angles with respect to the detector, are sequentially switched on to measure, in addition to the transmitted spectrum, the scattered spectra at the given angles. The transmitted spectrum mainly provides information regarding color, which is also dependent on the turbidity, while the scattered spectra mainly provide information on turbidity, which is also dependent on the color. Measurements on a vial filled by distilled water are carried out prior to sample analysis, so as to obtain reference signals. Then, the spectroscopic data are processed by means of chemometrics, thus providing few coordinates that summarize the combined effects of color and turbidity.



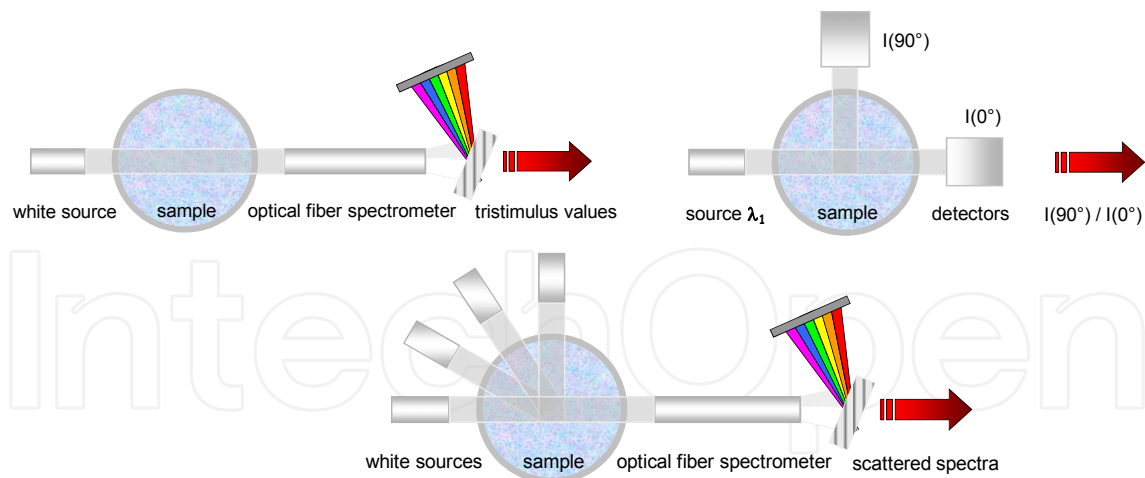

Fig. 7. The working principle of scattered colorimetry (bottom), compared to colorimetry (top-left) and turbidimetry (top-right)

Scattered colorimetry showed effectiveness in discriminating the geographic regions of production (Mignani et al., 2005). Figure 8 shows the clustering maps of a couple of experiments carried out by analyzing collections of extra virgin olive oils produced in different geographic regions of the Mediterranean area. Figure 8-left shows the 3D map obtained by LDA processing the spectra of a collection of 236 oils. The collection comprises 115 Tuscan and 53 Calabrian extra virgin olive oils produced by traditional methods, and 68 oils (58 extra virgin and 10 non extra virgin) purchased from retailers. The Tuscan oils are clearly distinguishable from the other extra virgin oils as are the Calabrian oils. As expected, the cluster of non extra virgin olive oils is distinctly separated. Figure 8-right shows another 2D map, again achieved by means of LDA processing of spectroscopic data of a collection of 270 extra virgin olive oils artesinally produced. This collection comprises 213 Italian (90 Tuscan and 123 Sicilian) and 57 Spanish samples. The olive oils of the two countries have intrinsic differences influenced by the diverse cultivars, weather conditions, harvest times, and production methods. An evident clustering according to geographic regions of origin is achieved.

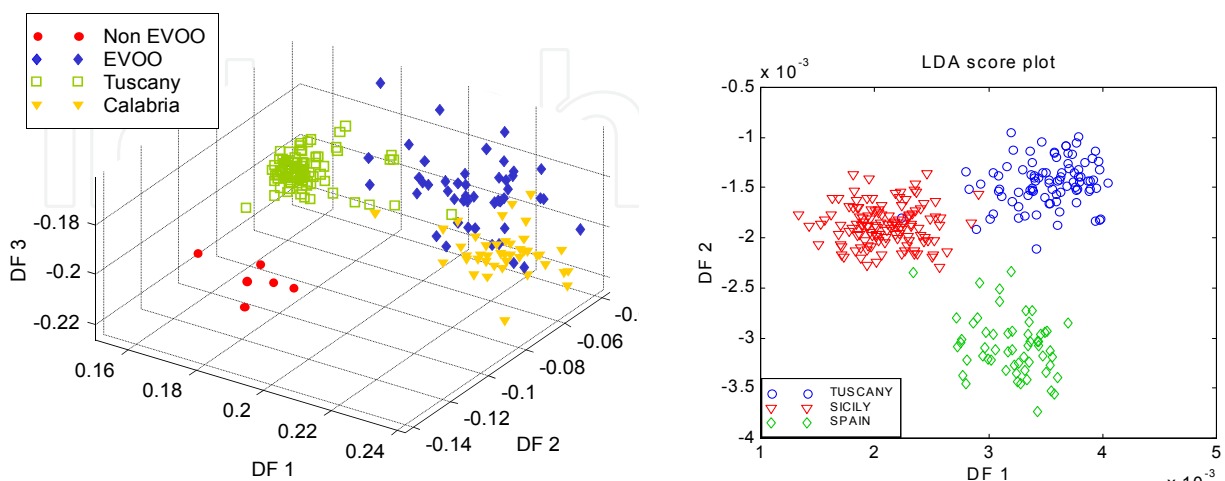

Fig. 8. Effectiveness of scattered colorimetry for discriminating the geographic area of production: Italian extra virgin olive oils from different regions and oils from retailers (left); Spanish and Italian oils (right) (with kind permission of Elsevier and SPIE)

## 5. UV-VIS-NIR absorption spectroscopy

The little VIS range used in scattered colorimetry only allows to classify oils according to their geographic region of production. In this paragraph, traditional absorption spectroscopy is discussed, which is applied to filtered olive oil samples in order to avoid the influence of turbidity. Indeed, traditional absorption spectroscopy, with or without optical fibers, is certainly the most frequently used spectroscopic technique for olive oil analysis. Since every spectroscopic range is bringing peculiar information, the combination of UV-VIS, or VIS-NIR bands, or the entire UV-VIS-NIR range makes it possible to achieve wider information. Nutraceutic parameters can be predicted, which allow to recognize olive oils of different qualities. In addition, mixtures of extra virgin with lower quality oils can be detected.

Many types of extra virgin olive oils of the Mediterranean region were classified according to their geographic origin by means of absorption spectroscopy combined to chemometrics. The NIR band was used to classify French oils from several regions holding quality labels as registered designation of origin; squalene and fatty acids were also predicted (Galtier et al., 2007). The NIR was also used to classify Spanish oils (Bertran et al., 2000), to predict acidity and peroxide index (Armenta et al., 2007), and to detect and quantify the adulteration with sunflower and corn oil (Özdemir et al., 2007) and other vegetable oils (Christy et al., 2004; Öztürk et al., 2010). Greek oils from Crete, Peloponnese and Central Greece were classified both by the UV-VIS (Kružlicová et al., 2008) and the VIS-NIR bands (Downey et al., 2003), the latter being effective for detecting the adulteration with sunflower oil (Downey et al., 2002). The UV-VIS band was also used to detect the adulteration of extra virgin olive oils mixed with lower quality olive oils (Torrecilla et al., 2010).

The entire UV-VIS-NIR spectrum was exploited to both classify according to geographic region of production, and to predict quality indicators of Italian extra virgin olive oils. The spectra shown in Figure 9-left refer to a collection of 80 extra virgin olive oils produced in four different regions of Italy: Lombardy, Tuscany, Calabria and Sicily. Lombardy is located in the northern part of Italy, Tuscany in the center, while Calabria and Sicily in the south, being Sicily the southwest region. A chemometric data processing of these spectra allowed to achieve the regional clustering shown in Figure 9-right, and to predict quality indicators, as shown in Tables 1 and 2 (Mignani et al., 2008).

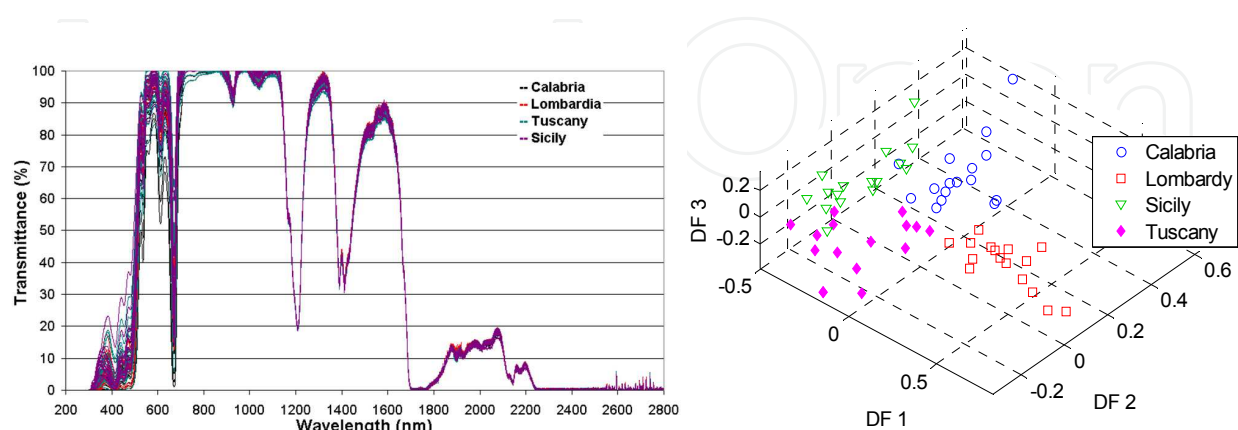

Fig. 9. Transmission spectra in the UV-VIS-VIR ranges of 80 extra virgin olive oil samples from four Italian regions (left), and regional clustering obtained by a chemometric processing of spectroscopic data (right) (with kind permission of SPIE)

Quality parameters	Calibration range	Spectroscopic range (nm)	Number of PLS regressors	R <sup>2</sup>
Oleic acidity (% oleic acid)	0.12 - 1.555	780 - 2500	3	0.8407
Peroxide value (meq O / kg. oil)	3.76 - 13.98	1000 - 2333	2	0.9628
K <sub>232</sub>	0.922 - 1.548	1333 - 2222	3	0.9942
K <sub>270</sub>	0.062 - 0.1178	1333 - 2222	3	0.9825
ΔK	-0.004 - 0.01	1333 - 2222	2	0.4344

Table 1. Prediction of quality parameters of the extra virgin olive oil collection of Figure 9

Fatty acids	Calibration range (%)	Spectroscopic range (nm)	# PLS regressors	R <sup>2</sup>
Oleic	65.847 - 76.334	1333 - 2222	1	0.9986
Palmitic	9.62 - 17.113	300 - 2300	2	0.9847
Linoleic	4.469 - 10.95	1333 - 2222	1	0.9553
Stearic	2.565 - 4.046	780 - 2500	2	0.9942
Palmiticoleic	0.367 - 1.457	1333 - 2222	2	0.9504
Linolenic	0.646 - 1.066	1000 - 2300	1	0.9822
Arachidic	0.382 - 0.642	1000 - 2222	1	0.9896
Eicosenoic	0.212 - 0.431	1000 - 2300	2	0.9821
Behenic	0.042 - 0.411	300 - 2300	2	0.8892
Heptadecenoic	0.053 - 0.356	300 - 2300	2	0.8081
Heptadecanoic	0.025 - 0.29	1000 - 2300	2	0.8337
Lignoceric	0.026 - 0.205	1333 - 2222	1	0.8532

Table 2. Prediction of fatty acids of the Sicilian extra virgin olive oils of Figure 9

## 6. Diffuse-light absorption spectroscopy

The scattered colorimetry technique allows for assessing the olive oil by considering both color and turbidity. Indeed, although the intrinsic turbidity of the oil can be regarded as a peculiar characteristic, it has an unstable and non-reproducible influence on absorption measurements because of its time dependent nature. In fact, suspended particles created during production of the olive oil usually settle down in a non-reversible way, because they tend to aggregate at the bottom of the container, creating a sort of sludge. Absorption spectroscopy in the UV-VIS-NIR of filtered samples demonstrated effectiveness to achieve wider quality information. However, sample filtering is not only a time-consuming procedure, but is also an action that alters the composition of the sample. In fact, turbidity is also due to the presence of water, and water removal causes a serious loss of water-soluble compounds—such as polyphenols—that are responsible for the unusual character and authenticity of olive oil.

Diffuse-light absorption spectroscopy, that is, spectroscopy carried out by means of an integrating cavity, is an alternative spectroscopic technique which allows to achieve scattering-free absorption spectra, that is, without caring about the intrinsic turbidity of the olive oil. It has been proposed in the literature as an effective method for overcoming scattering problems in process control (Fecht et al., 1999) and biological applications (Merzlyak et al., 2000), as well as for more general quantitative spectrophotometry (Jàvorfi et al., 2006).

Diffuse-light absorption spectroscopy makes use of an integrating sphere that contains the sample under test. The source and the detector are butt-coupled to the sphere, as shown in Figure 10.

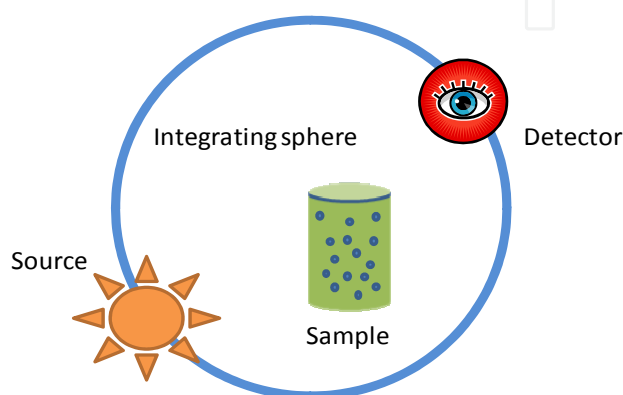

Fig. 10. Setup for diffuse-light absorption spectroscopy by means of an integrating sphere

Almost all the light shining on the sphere surface is diffusely reflected, and the detector can be placed anywhere in the sphere in order to gather the average flux (Elterman, 1970; Fry et al., 1992; Nelson et al., 1993; Kirk, 1995). By inserting an absorbing medium in the cavity, a reduction of the radiance in the sphere occurs. The reduction is related to the absorption of the medium and to its volume, and is independent of non-absorbing objects within it, such as suspended scattering particles. The light intensity detected by means of this measuring setup is described by Equation 4:

$$I = \frac{R I_0 A_d}{S} \frac{1}{1 - \frac{R}{S} (S - A_s - \alpha V)} \quad (4)$$

where  $I_0$ : source power;  $I$ : detected power;  $\alpha = \epsilon C$ : sample absorption coefficient;  $V$ : sample volume;  $A_d$ : detector area;  $A_s$ : source area;  $R$ : cavity power reflectivity;  $S$ : cavity surface area.

This technique was used to detect the adulteration of high quality extra virgin olive oils produced in Tuscany caused by lower quality olive oils such as olive pomace, refined olive pomace, refined olive, and deodorized olive oils (Mignani et al., 2011). Mixtures of four original extra virgin olive oils and the four types of adulterants were artificially created at different adulterant concentration. Figure 11-top shows the diffuse-light absorption spectra of high quality oils (left) and the others used as adulterants (right). Then, chemometrics was applied for achieving adulterant discrimination and prediction of relative concentration. Figure 11-bottom shows the discriminating maps: PCA was capable of discriminating

samples adulterated by means of deodorized olive oil (left), while a deeper LDA processing was needed for discriminating the other adulterants (right).

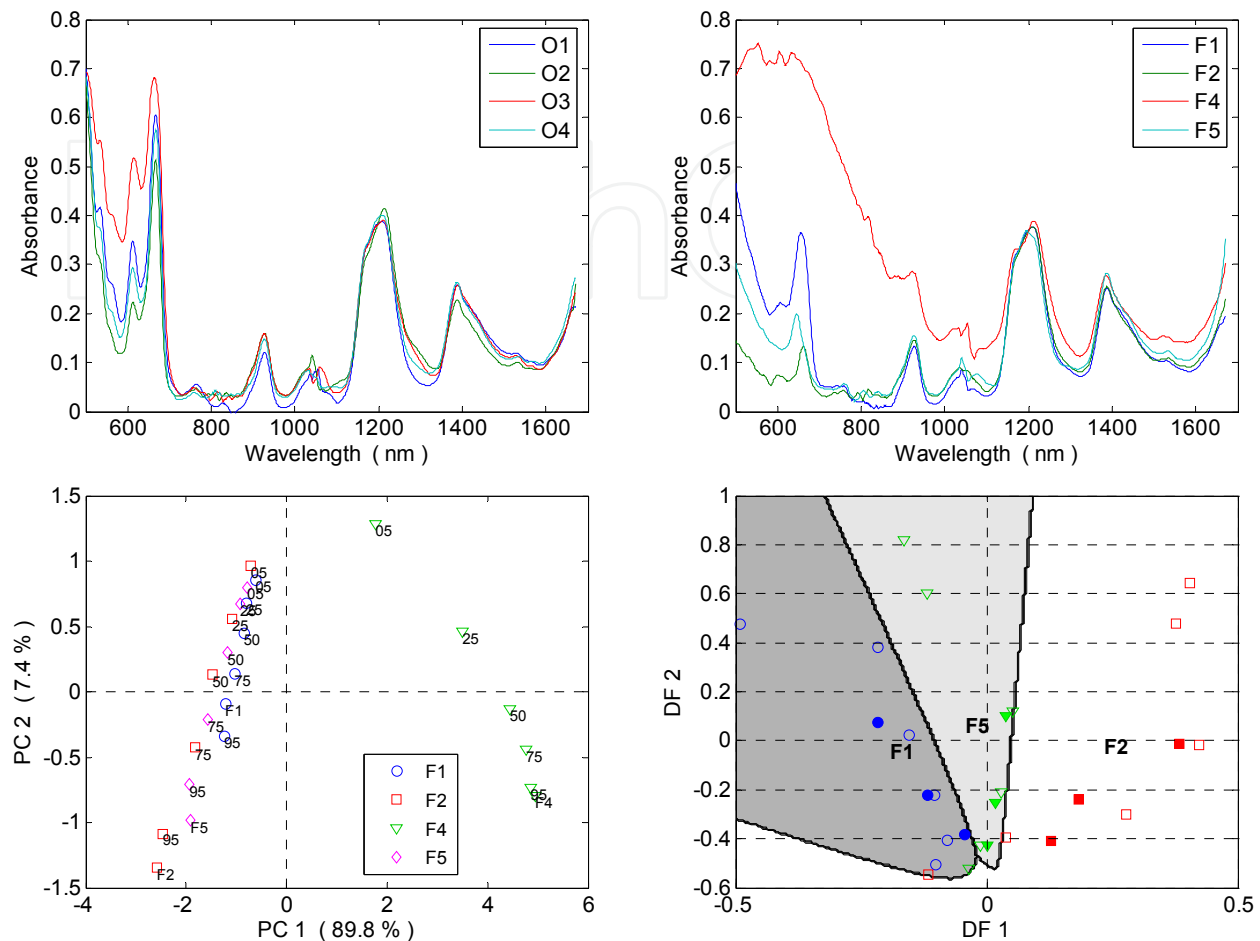

Fig. 11. Top: Diffuse-light absorption spectra of original extra virgin olive oils (left) and other lower quality olive oils commonly used as adulterants (right). Bottom: Discriminating maps obtained by chemometric data processing of absorption spectra (with kind permission of Springer Science+Business Media)

## 7. Perspectives

Absorption spectroscopy, carried out in the UV-VIS-NIR and combined with chemometrics, can be used for authentication, fraud detection, as well as for quantifying quality indicators. Optical fibers can be used for localized or online analyses.

Absorption spectroscopy for assessing the extra virgin olive oil can be performed also in other spectroscopic bands of the electromagnetic spectrum, especially in the mid-infrared (MIR) and far-infrared (FIR). Recently, NIR and MIR bands were successfully combined and showed effectiveness not only for classifying Italian and French olive oils (Sinelli et al., 2008; Galtier et al., 2011), but also for a classification on the basis of the fruity sensory attribute (Sinelli et al., 2010). The instrumentation for MIR absorption spectroscopy makes use of other types of sources/detectors/optics and measuring schemes. Usually, the attenuated total reflection modality is used, which allows absorption measurements even in high absorption liquids, like olive oil is in the MIR.



Other optical spectroscopic techniques are emerging for the quality assessment of extra virgin olive oils, especially the fluorescence and the Raman spectroscopies. The interested readers can have a look at the most recent bibliography (Ross Kunz et al., 2011; El-Abassy et al., 2010; Paiva-Martins et al., 2010; El-Abassy et al., 2009; Tena et al., 2009; Zou et al., 2009; Sikorska et al., 2008; Poulli et al., 2007).

## 8. Acknowledgments

Many sponsors and people contributed to the scientific work of the authors of this chapter. The following deserve a special acknowledgement:

- Projects: EC#SMT4-CT97-2157 "Optical Technologies for Intelligent Monitoring Online", EC#003887 "Network of Excellence for Micro-Optics", EC#224014 "Network of Excellence for Biophotonics", Regional Board of Tuscany "Biotechnological characterization and traceability of Tuscan wines and oils", the Spanish Government's Ministry of Science and Technology by means of TEC'2005-08218-C02-02 and TEC'2007-67987-C02-01 projects.
- People: Heidi Ottevaere and Hugo Thienpont, Vrije Universiteit Brussel-Belgium; Cristina Attilio, formerly at CNR IVALSÀ-Italy; Lanfranco Conte and Milena Marega, Università degli Studi di Udine-Italy; Angelo Cichelli, Università degli Studi di Pescara-Italy; Pilar Beatriz García-Allende and Olga Maria Conde, Universidad de Cantabria-Spain; Debora Tura, Università degli Studi di Milano-Italy.

## 9. References

- Armenta, S., Garrigues, S. & de la Guardia, M. (2007). Determination of edible oil parameters by near infrared spectrometry. *Analytica Chimica Acta*, Vol. 596, pp. 330-337.
- Bauman, R.P. (1962). *Absorption Spectroscopy*, John Wiley & Sons Inc., New York.
- Bertran, E., Blanco, M., Coello, J., Iturriaga, H., MasPOCH, S. & Montoliu, I. (2000). Near infrared spectrometry and pattern recognition as screening methods for the authentication of virgin olive oils of very close geographical origins. *Journal of Near Infrared Spectroscopy*, Vol. 8, pp. 45-52.
- Billmeyer, F.W. Jr. & Saltzman, M. (1981). *Principles of Color Technology*, Wiley, New York.
- Cerretani, L., Bendini, A., Rotondi, A., Lercker, G. & Gallina Toschi, T. (2005). Analytical comparison of monovarietal virgin olive oils obtained by both a continuous industrial plant and a low-scale mill. *European Journal of Lipid Science and Technology*, Vol. 107, pp. 93-100.
- Christy, A.A., Kasemsumra, S., Du, Y. & Ozaki, Y. (2004). The detection and quantification of adulteration in olive oil by near-infrared spectroscopy and chemometrics. *Analytical Sciences*, Vol. 20, pp. 935-940.
- Downey, G., McIntire, P. & Davies, A.Y. (2002). Detecting and quantifying sunflower oil adulteration in extra virgin olive oils from the Eastern Mediterranean by visible and near-infrared spectroscopy. *Journal of Agricultural and Food Chemistry*, Vol. 50, pp. 5520-5525.

- Downey, G., McIntyre, P. & Davies, A.N. (2003). Geographic classification of extra virgin olive oils from the Eastern Mediterranean by chemometric analysis of visible and near-infrared spectroscopic data. *Applied Spectroscopy*, Vol. 57, pp. 158-163.
- El-Abassy, R.M., Donfack, P. & Materny, A. (2009). Visible Raman spectroscopy for the discrimination of olive oils from different vegetable oils and the detection of adulteration. *Journal of the Science of Food and Agriculture*, Vol. 40, pp. 1284-1289.
- El-Abassy, R.M., Donfack, P. & Materny, A. (2010). Assessment of conventional and microwave heating induced degradation of carotenoids in olive oil by VIS Raman spectroscopy and classical methods. *Food Research International*, Vol. 43, pp. 694-700.
- Elterman, P. (1970). Integrating cavity spectroscopy. *Applied Optics*, Vol. 9, pp. 2140-2142.
- Fecht, I. & Johnson, M. (1999). Non-contact scattering independent water absorption measurement using a falling stream and integrating sphere. *Measurement, Science & Technology*, Vol. 10, pp. 612-618.
- Fry, E.S., Kattawar, G.W. & Pope, R.M. (1992). Integrating cavity absorption meter. *Applied Optics*, Vol. 31, pp. 2055-2065.
- Galtier, O., Dupuy, N., Le Dréau, Y., Ollivier, D., Pinatel, C., Kister, J. & Artaud, J. (2007). Geographic origins and compositions of virgin oils determined by chemometric analysis of NIR spectra. *Analytica Chimica Acta*, Vol. 595, pp. 136-144.
- Galtier, O., Abbas, O., Le Dréau, Y., Rebufa, C., Kister, J., Artaud, J. & Dupuy, N. (2011). Comparison of PLS1-DA, PLS2-DA and SIMCA for classification by origin of crude petroleum oils by MIR and virgin olive oils by NIR for different spectral regions. *Vibrational Spectroscopy*, Vol. 55, pp. 132-140.
- Hunt, R.W.G. (1987). *Measuring Color*, Wiley, New York.
- Ingle, J.D.J. & Crouch S.R. (1988). *Spectrochemical Analysis*. Prentice Hall, New Jersey.
- ISO-International Organization for Standards. (1999). ISO-7027
- Jackson, J.E. (2003). *A User's Guide to Principal Components*, J. Wiley & Sons Inc., Hoboken.
- Jávorfí, T., Erostyák, J., Gál, J., Buzády, A., Menczel, L., Garab, G. & Razi Naqvi, K. (2006). Quantitative spectrophotometry using integrating cavities. *Journal of Photochemistry and Photobiology B: Biology*, Vol. 82, pp. 127-131.
- Jiménez Márquez, A. (2003). Monitoring carotenoid and chlorophyll pigments in virgin olive oil by visible-near infrared transmittance spectroscopy. *Journal of Near Infrared Spectroscopy*, Vol. 11, pp. 219-226.
- Kirk, J.T.O. (1995). Modeling the performance of an integrating-cavity absorption meter: theory and calculations for a spherical cavity. *Applied Optics*, Vol. 34, pp. 4397-4408.
- Kružlicová, D., Mocák, J., Katsoyannos, E. & Lankmayr, E. (2008). Classification and characterization of olive oils by UV-Vis absorption spectrometry and sensorial analysis. *Journal of Food Nutrition Research*, Vol. 47, pp. 181-188.
- Lee, C.H. & Hill, T.W. (2011). *Light-Matter Interaction*. Wiley online library, DOI:10.1002/9783527619016.index
- Mark, H. & Workman, J. Jr. (2007). *Chemometrics in Spectroscopy*, Academic Press, London.
- Mellon, M.G. (1950). *Analytical Absorption Spectroscopy*, John Wiley & Sons Inc., New York.
- Merzlyak, M.N. & Razi Naqvi, K. (2000). On recording the true absorption spectrum and the scattering spectrum of a turbid sample: application to cell suspensions of the cyanobacterium *Anabaena variabilis*. *Journal of Photochemistry and Photobiology B: Biology*, Vol. 58, pp. 123-129.

- Mignani, A.G., Smith, P.R., Ciaccheri, L., Cimato, A. & Sani, G. (2003). Spectral nephelometry for making extravirgin olive oil fingerprints. *Sensors and Actuators B*, Vol. 90, pp. 157-162.
- Mignani, A.G., Ciaccheri, L., Cimato, A., Attilio, C. & Smith, P.R. (2005) Spectral nephelometry for the geographic classification of Italian extra virgin olive oils. *Sensors and Actuators B*, Vol. 111-112, pp. 363-369.
- Mignani, A.G., García-Allende, P.B., Ciaccheri, L., Conde, O.M., Cimato, A., Attilio, C. & Tura, D. (2008). Comparative analysis of quality parameters of Italian extra virgin olive oils according to their region of origin. *Proceedings of SPIE: Optical Sensors 2008*, Vol. 7003, pp. 700326-1/6.
- Mignani, A.G., Ciaccheri, L., Ottevaere, H., Thienpont, H., Conte, L., Marega, M., Cichelli, A., Attilio, C. & Cimato, A. (2011). Visible and near-infrared absorption spectroscopy by an integrating sphere and optical fibers for quantifying and discriminating the adulteration of extra virgin olive oil from Tuscany. *Analytical, Bioanalytical Chemistry*, Vol. 399, pp. 1315-1324.
- Nelson, N.B. & Prézelin, B.B. (1993). Calibration of an integrating sphere for determining the absorption coefficient of scattering suspensions. *Applied Optics*, Vol. 32 pp. 6710-6717.
- Osborne, B.G., Fearn, T. & Hindle, P.T. (1993). *Practical NIR Spectroscopy with Applications in Food and Beverage Analysis*, Longman Scientific & Technical-Wiley, New York.
- Osborne, B.G. (2000). Near-infrared spectroscopy in food analysis, In: *Encyclopedia of Analytical Chemistry*, Meyers, R.A. (Ed.), pp. 1-14, J. Wiley & Sons Ltd., Chichester.
- Ozaki, Y., McClure, W.F. & Christy, A.A. (2007). *Near Infrared Spectroscopy in Food Science and Technology*, J. Wiley & Sons, Hoboken.
- Özdemir, D. & Öztürk, B. (2007). Near infrared spectroscopic determination of olive oil adulteration with sunflower and corn oil. *Journal of Food and Drug Analysis*, Vol. 15, pp. 40-47.
- Öztürk, B., Yalçın, A. & Özdemir, D. (2010). Determination of olive oil adulteration with vegetable oils by near infrared spectroscopy coupled with multivariate calibration. *Journal of Near Infrared Spectroscopy*, Vol. 16, pp. 191-201.
- Paiva-Martins, F., Rodrigues, V., Calheiros, R. & Marques, M.P.M. (2010). Characterization of antioxidant olive oil biophenols by spectroscopic methods. *Journal of the Science of Food and Agriculture*, Vol. 91, pp. 309-314.
- Poulli, K.I., Mousdis, G.A. & Georgiou, A. (2007). Rapid synchronous fluorescence method for virgin olive oil adulteration assessment. *Food Chemistry*, Vol. 105, pp. 369-375.
- Ross Kunz, M., Ottaway, J., Kalivas, J.H., Georgiou, C.A. & Mousdis, G.A. (2011). Updating a synchronous fluorescence spectroscopic virgin olive oil adulteration calibration to a new geographical region. *Journal of the Agricultural and Food Chemistry*, Vol. 59, pp. 1051-1057.
- Sikorska, E., Khmelinskii, I.V., Sikorski, M., Caponio, F., Bilancia, M.T., Pasqualone, A. & Gomes, T. (2008). Fluorescence spectroscopy in monitoring of extra virgin olive oil during storage. *International Journal of Food Science and Technology*, Vol. 43, pp. 52-61.
- Sinelli, N., Casiraghi, E., Tura, D. & Downey, G. (2008). Characterisation and classification of Italian virgin oil by near- and mid-infrared spectroscopy. *Journal of Near Infrared Spectroscopy*, Vol. 16, pp. 335-342.

- Sinelli, N., Cerretani, L., Di Egidio, V., Bendini, A. & Casiraghi, E. (2010). Application of near (NIR) infrared and mid (MIR) infrared spectroscopy as a rapid tool to classify extra virgin olive oil on the basis of fruity attribute intensity. *Food Research International*, Vol. 42, pp. 369-375.
- Torrecilla, J.S., Rojo, E., Domínguez, J.C. & Rodríguez, F. (2010). A novel method to quantify the adulteration of extra virgin olive oil with low-grade olive oils by UV-Vis. *Journal of Agricultural and Food Chemistry*, Vol. 58, pp. 1679-1684.
- Tena, N., García-González, D.L. & Aparicio, R. (2009). Evaluation of virgin oil thermal deterioration by fluorescence spectroscopy. *Journal of the Agricultural and Food Chemistry*, Vol. 57, pp. 10505-10511.
- Vandeginste, B.G.M., Massart, D.L., Buydens, L.C.M., De Jong, S., Lewi, D.J. & Smeyers-Verbeke, J. (1998). *Handbook of Chemometrics and Qualimetrics*, Elsevier Science BV, Amsterdam—chapter 33.
- Wold, S., Sjöström, M. & Eriksson, L. (2001). PLS-regression: a basic tool for chemometrics. *Chemometrics and Intelligent Laboratory Systems*, Vol. 58, pp. 109-130.
- Wrolstad, R.E., Acree, T.E., Decker, E.A., Penner, M.H., Reid, D.S., Schwartz, S.J., Shoemaker, C.F. & Sporns, P. (2005). *Handbook of Food Analytical Chemistry, Pigments, Colorants, Flavours, Texture, and Bioactive Food Components*, J. Wiley & Sons, Hoboken.
- Zou, M.Q., Zhang, X.F., Qi, X.H., Ma, H.L., Dong, Y., Liu, C.W., Guo, X. & Wang, H. (2009). Rapid authentication of olive oil adulteration by Raman spectrometry. *Journal of the Agricultural and Food Chemistry*, Vol. 57, pp. 6001-6006.

IntechOpen

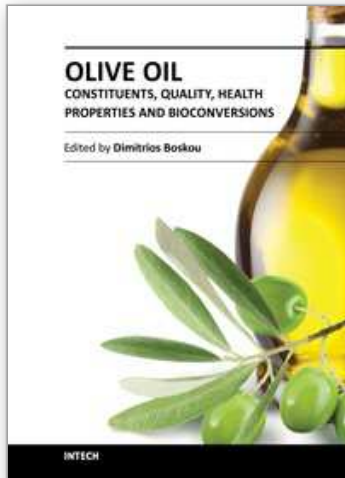

## **Olive Oil - Constituents, Quality, Health Properties and Bioconversions**

Edited by Dr. Dimitrios Boskou

ISBN 978-953-307-921-9

Hard cover, 510 pages

**Publisher** InTech

**Published online** 01, February, 2012

**Published in print edition** February, 2012

The health-promoting effects attributed to olive oil, and the development of the olive oil industry have intensified the quest for new information, stimulating wide areas of research. This book is a source of recently accumulated information. It covers a broad range of topics from chemistry, technology, and quality assessment, to bioavailability and function of important molecules, recovery of bioactive compounds, preparation of olive oil-based functional products, and identification of novel pharmacological targets for the prevention and treatment of certain diseases.

### **How to reference**

In order to correctly reference this scholarly work, feel free to copy and paste the following:

Anna Grazia Mignani, Leonardo Ciaccheri, Andrea Azelio Mencaglia and Antonio Cimato (2012). Optical Absorption Spectroscopy for Quality Assessment of Extra Virgin Olive Oil, *Olive Oil - Constituents, Quality, Health Properties and Bioconversions*, Dr. Dimitrios Boskou (Ed.), ISBN: 978-953-307-921-9, InTech, Available from: <http://www.intechopen.com/books/olive-oil-constituents-quality-health-properties-and-bioconversions/optical-absorption-spectroscopy-for-quality-assessment-of-extra-virgin-olive-oil>

# **INTECH**

open science | open minds

### **InTech Europe**

University Campus STeP Ri  
Slavka Krautzeka 83/A  
51000 Rijeka, Croatia  
Phone: +385 (51) 770 447  
Fax: +385 (51) 686 166  
[www.intechopen.com](http://www.intechopen.com)

### **InTech China**

Unit 405, Office Block, Hotel Equatorial Shanghai  
No.65, Yan An Road (West), Shanghai, 200040, China  
中国上海市延安西路65号上海国际贵都大饭店办公楼405单元  
Phone: +86-21-62489820  
Fax: +86-21-62489821



© 2012 The Author(s). Licensee IntechOpen. This is an open access article distributed under the terms of the [Creative Commons Attribution 3.0 License](#), which permits unrestricted use, distribution, and reproduction in any medium, provided the original work is properly cited.

IntechOpen

IntechOpen