

# We are IntechOpen, the world's leading publisher of Open Access books Built by scientists, for scientists

5,300

Open access books available

130,000

International authors and editors

155M

Downloads

Our authors are among the

154

Countries delivered to

TOP 1%

most cited scientists

12.2%

Contributors from top 500 universities



WEB OF SCIENCE™

Selection of our books indexed in the Book Citation Index  
in Web of Science™ Core Collection (BKCI)

Interested in publishing with us?  
Contact [book.department@intechopen.com](mailto:book.department@intechopen.com)

Numbers displayed above are based on latest data collected.  
For more information visit [www.intechopen.com](http://www.intechopen.com)



---

# Multuser MAC Schemes for High-Throughput IEEE 802.11n/ac WLANs

---

Elli Kartsakli, Nizar Zorba, Luis Alonso and Christos Verikoukis

Additional information is available at the end of the chapter

<http://dx.doi.org/10.5772/57129>

---

## 1. Introduction

In the last decade, the Wireless Local Area Network (WLAN) market has been experiencing an impressive growth that began with the broad acceptance of the IEEE 802.11 standard [1]. Given the widespread deployment of WLANs and the increasing requirements of multimedia applications, the need for high capacity and enhanced reliability has become imperative. Multiple-Input Multiple-Output (MIMO) technology and its single receiving antenna version, MISO (Multiple-Input Single-Output (MISO)), promise a significant performance boost and have been incorporated in the emerging IEEE 802.11n standard [2].

Several multiple antenna transmission techniques such as spatial multiplexing and transmit beamforming are used to provide rapid and robust point-to-point wireless connectivity. On the other hand, due to the inherent diversity of the MIMO channel, it is possible to achieve simultaneous point-to-multipoint transmissions and serve multiple users at the same time, through the same frequency. The MIMO multiuser transmission concept, where multiple users are served through different data streams, can increase the overall system capacity when compared to single-user MIMO transmission, where all streams are dedicated to just one user [3].

Even though IEEE 802.11n has been designed with MIMO technology in mind, its main focus is on maximizing throughput in point-to-point transmissions, through spatial multiplexing and mechanisms such as frame aggregation. Neither the standard nor the majority of related work consider any Medium Access Control (MAC) mechanisms for multiuser scheduling, thus leaving a significant MIMO capability unexploited. As accurately pointed out in [4], there is a need for low-complexity multiuser transmission schemes, especially for downlink communications.

Recently, the IEEE 802.11ac task group has been working on an amendment of the 802.11 standard aiming to extend the total network throughput beyond the gigabit-per-second

barrier. The new draft standard contemplates, among other things, multiuser transmissions in the downlink but leaves many open issues, especially on multiuser scheduling.

Motivated by this open line of work, this chapter is dedicated to the investigation of solutions for the incorporation of multiuser capabilities in IEEE 802.11n/ac WLAN systems by using Cross-Layer (CL) information, while maintaining backward compatibility with the standard. The main contribution is the design of a number of opportunistic channel-aware multiple antenna MAC schemes that handle multiuser downlink transmissions and explore the advantages that can be gained by exploiting multiuser diversity. Backward compatibility with the existing 802.11n standard and possible integration within the new 802.11ac draft standard are also key issue.

The remaining part of this chapter is divided into six sections. Section 2 provides an overview of the state of the art on multiuser MAC layer protocols, a review of the multiuser mechanism included in the 802.11ac draft standard and the additional challenges that arise from simultaneous transmissions. Section 3 discusses the problem statement and presents the Employed beamforming transmission technique. The description of the proposed multiuser MAC schemes is given in Section 4. Section 5 provides the performance evaluation of the proposed schemes and discusses the obtained trade-offs and finally, Section 6 closes the chapter with some general conclusions.

## 2. State of the art

Multiuser transmissions require the use of multiple antenna transmission techniques and advanced signal processing at the Physical (PHY) layer, as well as more complex MAC layer schemes. An overview of the most representative transmission techniques for smart antennas and MIMO systems is given in Section 2.1, whereas the available multiuser MAC schemes are presented in Section 2.2. Finally, a brief description of the multiuser capabilities of the IEEE 802.11ac draft standard and the relevant open issues are presented in Section 2.3.

### 2.1. PHY layer techniques for multiple antenna systems

In recent years, the technology of smart antennas has been widely investigated in an effort to increase the capacity of wireless networks. A smart antenna system combines multiple spatially distributed antenna elements with intelligent signal processing algorithms that adjust the antenna radiation pattern in order to achieve some desired objective. Smart antennas can be classified into three categories according to their level of intelligence [5]:

- The *switched beam antennas* have the lowest intelligence and can employ beamforming towards specific, predefined directions.
- The *dynamically phased antennas* can determine the direction of arrival of a received signal and steer a beam towards that direction to enhance reception.
- Finally, the *adaptive array antennas* can additionally adjust their radiation pattern to null out interference sources.

MIMO systems employ smart antenna technology with a high level of intelligence, aiming to improve transmission rates and enhance reliability and robustness. The term MIMO implies the availability of at least two antennas at each end of the communication link. When multiple antennas are employed only at the transmitter side the system is known

as Multiple-Input Single-Output (MISO), whereas Single-Input Multiple-Output (SIMO) systems imply a single transmitting and multiple receiving antennas.

There are several techniques for the exploitation of multiple antennas at the PHY layer, schematically illustrated in Figure 1. A brief description of each technique will be given next, but more detailed explanation can be found in [6] and [7].

The most conventional techniques are beamforming and interference suppression, shown in Figure 1a. By means of beamforming, the received signal strength of a point-to-point communication link is increased thus resulting to higher supported data rates and extended coverage range. Interference suppression is achieved by steering the nulls of the antenna radiation pattern towards specific directions. This technique can be employed to reduce the interference produced by the transmitter but also to limit the received interference by other systems. As a result the link reliability and the spectral efficiency of the system are enhanced.

Another very efficient technique is spatial diversity that effectively mitigates multi-path fading and therefore provides increased robustness against errors (Figure 1b). Depending on whether the multiple antenna elements are placed at the receiver (SIMO) or the transmitter (MISO), the spatial diversity schemes can be classified as receive and transmit diversity, respectively. In receive-diversity schemes, independently faded copies (due to different propagation paths) of the same signal arrive at each antenna element of the receiver and are appropriately combined or selected to enhance reception [8]. In transmit-diversity schemes the same signal is transmitted over multiple antennas after some processing has taken place to ensure that the received multiple copies of the signal will be successfully separated by the receiver [9][10][11]. Clearly, in MIMO systems, joint receive and transmit diversity schemes can be implemented.

A very powerful transmit-diversity technique that achieves both diversity and coding gain is the Space-Time Coding (STC) that involves signal coding over space (multiple antennas) and time (multiple symbol times). There are two main approaches to STC design, the Space-Time Trellis Coding (STTC) [12] and the Space-Time Block Coding (STBC) [13][14]. STTC provides considerable coding and diversity gains with the cost of high decoding complexity. On the other hand, STBC is less efficient since it mainly offers diversity gain (and minimal or zero coding gain) but has the significant property of using linear decoding at the receiver.

Another PHY layer technique is spatial multiplexing (Figure 1c), according to which multiple independent data streams are simultaneously transmitted in the same frequency spectrum using multiple antennas. The receiver manages to extract the data streams from the received signal by employing spatial processing techniques that exploit multi-path fading. As a result, the throughput performance is increased. A very popular and spectral efficient spatial multiplexing scheme is V-BLAST (Vertical- Bell Laboratories Layered Space Time) [15]. As far as point-to-multipoint links are concerned, the spatial multiplexing of signals known as SDMA allows multiple simultaneous transmissions in the same frequency, thus multiplying the capacity of the system [16].

Summarizing, the main PHY layer techniques that are available in multiple antenna systems are beam-forming, interference cancellation, spatial diversity and spatial multiplexing. These techniques can be used separately or in combination, to obtain the desired effect. Finally, it has been demonstrated that there is a fundamental trade-off between diversity gain and

spatial multiplexing gain that reflects to a design decision in favor of increased reliability or throughput, respectively [17][18].

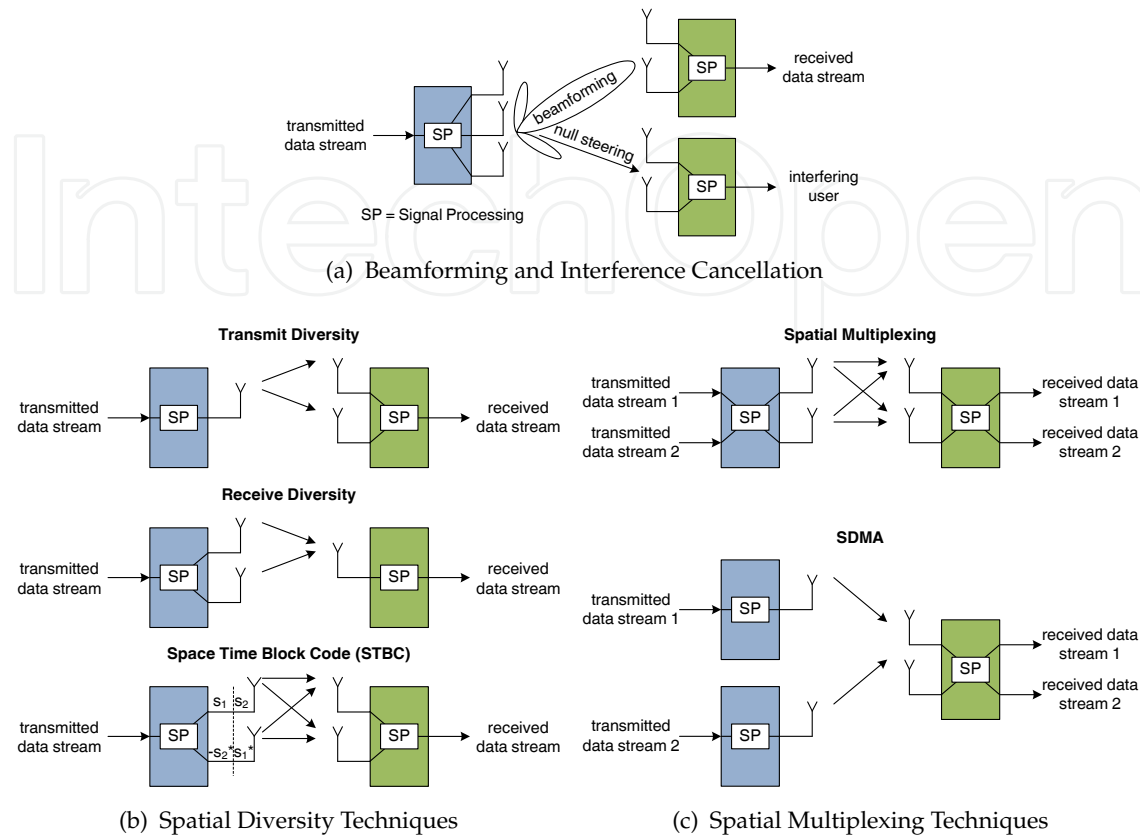

**Figure 1.** Multiple antenna transmission techniques

## 2.2. MAC protocols for multiuser transmissions

An overview of the most representative examples of multiuser scheduling and resource allocation can be found in [19]. The authors stress that selecting the best user subset for each transmission is the key to achieving multiuser diversity, but also point out several practical issues that must be taken care of, including the need for feedback acquisition on the channel state.

A significant number of contributions has been dedicated to the development of user selection and scheduling algorithms in the context of multiple antenna systems. An early work proposes the first-fit algorithm, a sub-optimum but less complex scheduling method that selects sets of packets that can be transmitted simultaneously [20]. However, one of the basic assumptions of this work is that the channel between the base station and the users is quasi-static and is considered known by the base-station, whereas scenarios with varying channel conditions are left for future consideration. In [21] the authors propose a SDMA/TDMA scheduler that assigns packets to time slots depending on their Quality of Service (QoS) requirements. Multiple packets can be spatially multiplexed in the same slot if they satisfy a Signal-to-Noise-and-Interference Ratio (SNIR) constraint. Again, this work mainly focuses on the scheduling policy and assumes that the spatial signature and QoS requirements for each packet are acquired during an initial admission phase.

Nevertheless, in realistic scenarios the channel condition cannot be considered known and a feedback mechanism must be established. Naturally, there is a trade-off between the potential performance enhancement when the channel is known and the reduced efficiency due to the introduced control overhead required for the feedback mechanism. One way to decrease feedback is by applying a threshold to exclude users with poor channel conditions from gaining access to the channel. This idea has been extensively studied in [22]. This work offers some guidelines for the threshold selection but it does not consider a specific multiple access scheme, nor the implementation of an actual feedback acquisition mechanism. In a different approach, binary feedback (1 or 0) is used by users to express whether they satisfy the threshold condition [23]. The idea is effective but assumes the presence of a dedicated low bit rate feedback channel, which is not the case in IEEE 802.11 based WLANs. Finally, another proposal combines the principle of splitting algorithms with threshold selection to determine the user with the best channel in less than three slots on average [24]. This work has been extended to provide detection of multiple users with good channel and needs on average 4.4 slots to find the best two users in the system [25].

Finally, there are some contributions that aim to include multiuser MAC schemes for IEEE 802.11 based systems. One example is the Multi-User Distributed Coordination Function (MU-DCF), presented in [26], that uses a four-way handshake that begins with a polling multiuser RTS frame. However there are several issues, mostly regarding the PHY layer implementation, that are not considered. A mathematical model for a downlink multiuser scheme for IEEE 802.11 is given in [27]. They show that performance can be improved by exploiting spatial multiplexing and conclude that there is still a need to design a modified MAC to support multiple transmissions and perform a good channel estimation mechanism.

### **2.3. Multiuser transmissions in the IEEE 802.11ac draft standard**

In an effort to obtain WLAN throughputs beyond the gigabit per second barrier, a new draft standard, the IEEE 802.11 ac, is being developed, to extend the 802.11n capabilities in the 5 GHz band. The main target of the IEEE 802.11ac draft standard is to provide high aggregate throughput beyond 1 Gbps. The task group is currently in the process of developing the draft 7.0 version of the standard, with the final approval of the amendment expected towards the first quarter of 2014.

An important innovative feature of IEEE 802.11ac is the support of point-to-multipoint transmissions that are possible thanks to the multiuser capability of MIMO systems. In other words, a MU-MIMO capable device can transmit multiple packets simultaneously to multiple destinations. A maximum number of four users can be simultaneously supported and up to eight spatial streams can be employed for transmissions (with a maximum of four spatial streams per user).

The standard is not yet in its final form, but the most prevailing approach so far for the scheduling of multiple data frames is presented in [28]. The authors propose some modifications to the IEEE 802.11 backoff procedure and introduce new mode known as sharing of the transmission opportunity limit (TXOP). The main idea is that when a station gains access to the channel, it may be allowed to transmit simultaneously multiple packets that may belong to different access categories (i.e., traffic priorities), something that was not permitted in previous versions of IEEE 802.11. However, the exact rules of packet selection

among the different access categories, and more generally, user and resource allocation issues and rate adaptation are not explicitly defined in the IEEE 802.11ac draft standard and pose interesting open issues.

### 3. System setup and multiuser physical layer

This section discusses the problem statement and describes the considered setup. In continuation, a brief description of the channel model is given and the multiuser transmission technique used at the PHY layer is explained. In general, the IEEE 802.11n MIMO specification with OFDM has been considered as the base for the PHY layer, with some modifications that will be explained in this section.

#### 3.1. Problem statement and system setup

As indicated in the state of the art, it can generally be said that most contributions on multiuser transmission schemes focus on particular aspects of the problem and simplify the rest. Usually, when the focus is laid on the PHY layer transmission techniques, practical mechanisms for the channel access and the feedback acquisition are not considered, whereas multiuser MAC schemes often fail to consider PHY layer implementation issues. For example, some schemes optimize resource allocation but ignore feedback mechanisms and others minimize the required feedback but assume a dedicated control channel and a less sophisticated scheduling policy.

This chapter will introduce a multiuser MAC mechanism that handles in a joint manner the processes of channel access, scheduling, channel estimation and feedback acquisition, in conjunction with a low-complexity beamforming technique at the PHY layer. The proposed schemes have been designed in the context of a downlink communication channel in an infrastructure WLAN in which multiple antennas are available at the transmitter side. Without loss of generality, a MISO scenario with single-antenna users has been considered, even though the presented analysis can be also applied to MIMO systems with multiple-antenna users.

The considered setup is illustrated in Figure 2. The proposed schemes can be considered as a downlink transmission phase, initiated by an Access Point (AP) equipped with  $n_t$  antennas ( $n_t \geq 2$ ) in a system with  $N$  single-antenna users. By exploiting the MIMO/MISO spatial signal processing capabilities and employing an appropriate transmission technique, the AP can serve up to  $n_t$  users at the same frequency and time. Nevertheless, in order to extract multiuser diversity gain, the pool of served users should exceed the number of transmitting antennas (i.e.,  $N > n_t$ ). Transmitting multiple downlink packets simultaneously, however, is feasible only when there is no interference among the selected users, or in a more realistic case, when the interference is relatively low. Hence, the AP must have some knowledge of the channel to select the most appropriate set of users for each transmission. These issues must be handled by the MAC layer in a practical way, as it will be described in detail in the following sections.

#### 3.2. MIMO/MISO channel

With the use of OFDM, the frequency selective MIMO/MISO channel is transformed into a number of frequency flat channels. In particular, a block-fading model is considered

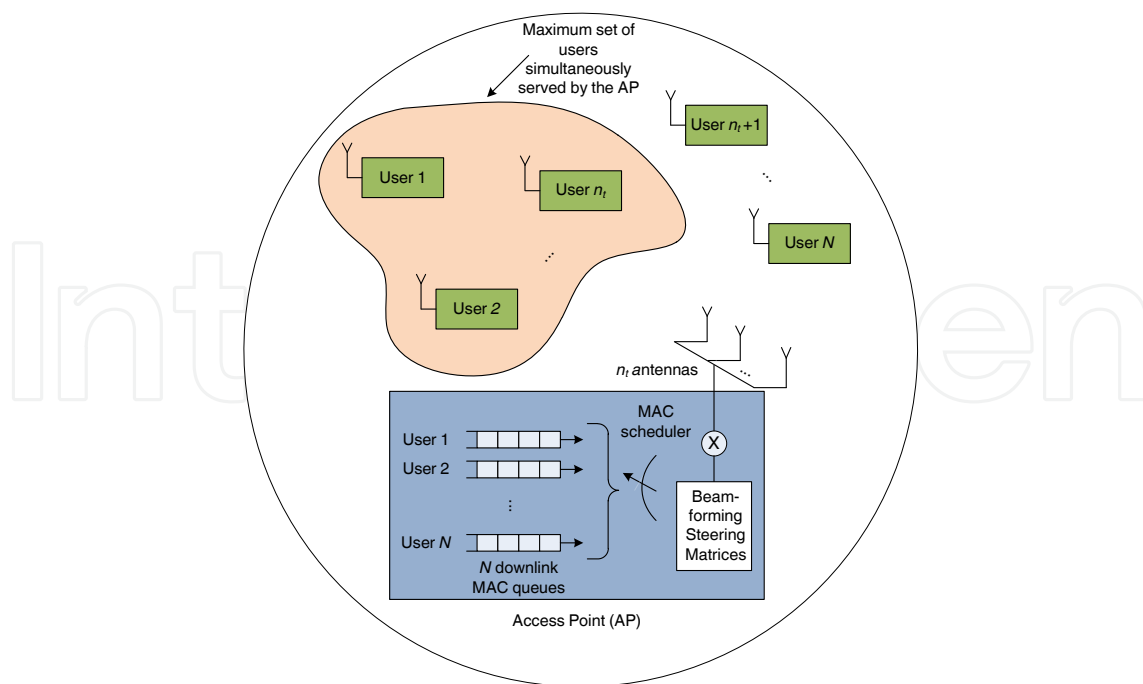

**Figure 2.** Scenario setup

for the channel which remains constant during the coherence time and changes between consecutive time intervals with independent and identically distributed complex Gaussian entries  $\sim \mathcal{CN}(0,1)$ . This model represents the IEEE 802.11n channel model B in NLOS conditions [29], assuming that there are no time correlations among the different blocks and that the channel impulse response changes at a much slower rate than the transmitted baseband signal.

In the considered MISO downlink scenario, the channel between the AP that is equipped with  $n_t$  antennas and the  $i$ th single-antenna user (out of  $N$  total users with  $N > n_t$ ) is described by a  $1 \times n_t$  complex channel matrix  $\mathbf{h}_i(t)$ . Let  $\mathbf{x}(t)$  be the  $n_t \times 1$  vector with the transmitted signal to all the selected users in a particular transmission sequence and  $y_i(t)$ . Then, the received signal for the  $i^{th}$  user can be expressed as

$$y_i(t) = \mathbf{h}_i(t)\mathbf{x}(t) + z_i(t) \quad (1)$$

where  $z_i(t)$  is an additive Gaussian complex noise component with zero mean and  $E\{|z_i|^2\} = \sigma^2$  is the noise variance. The transmitted signal  $\mathbf{x}(t)$  encloses the independent data symbols  $s_i(t)$  to all the selected users with  $E\{|s_i|^2\} = 1$ . A total transmitted power constraint  $P_t = 1$  is considered and for ease of notation, time index is dropped whenever possible.

### 3.3. Multibeam Opportunistic Beamforming (MOB)

Multibeam Opportunistic Beamforming (MOB) is a low-complexity transmission technique for multiple-antenna broadcast channels [30]. MOB requires the presence of multiple antennas at the transmitter side and one or more antennas at each receiving user, meaning that it can be applied to MISO or MIMO scenarios. Its goal is to exploit multiuser diversity



by finding a set of orthogonal users that can be simultaneously served on orthogonal beams, while maintaining the interference low. The key advantage of this transmission scheme is that it only requires partial Channel State Information (CSI) at the transmitter side in terms of the user received SNIR, making it very suitable for multiuser downlink communications.

The main steps of MOB are illustrated in Figure 3. It should be mentioned that these steps describe the main concept behind the MOB scheme without entering into implementation details. These will be more thoroughly addressed in Section 4 where the description of the proposed multiuser MAC schemes will take place. At the beginning of each transmission sequence, the AP forms  $n_t$  random orthogonal beams, equal to the number of its transmitting antennas (plot (a)). The users measure the SNIR related to each beam, select the highest measured SNIR value to the AP (plot (b)). In turn, the AP selects the best user for each beam and initiates the downlink data transmission (plot (c)). The scheme presented in [30] involves the opportunistic transmission by the users with the highest instantaneous SNIR for each beam, although MOB can also be combined with different scheduling policies.

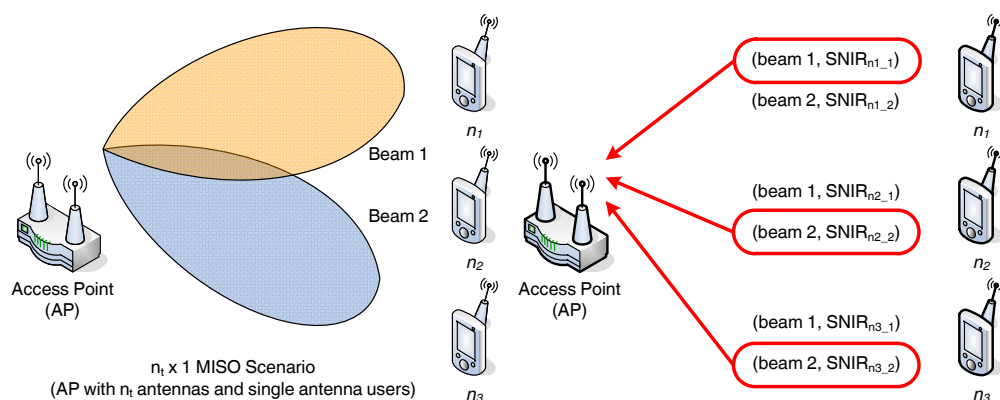

(a) MOB Step 1: The AP generates  $n_t$  random orthonormal beams (b) MOB Step 2: Users measure the SNIR on each beam and feed back their best value

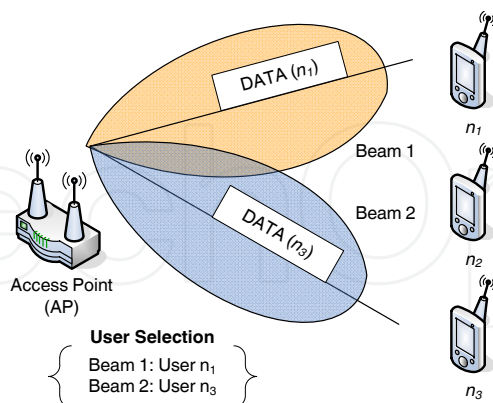

(c) MOB Step 3: The AP maps best users on beams and begins downlink transmission

**Figure 3.** Basic steps of MOB transmission technique

Through this low-complexity processing based on the instantaneous SNIR values, the MOB scheme achieves a high system sum rate by spatially multiplexing several users at the same

time. In the best case where  $n_t$  users are selected for downlink transmission, the transmitted signal  $\mathbf{x}$  can be expressed as

$$\mathbf{x} = \sqrt{\frac{1}{n_t}} \sum_{k=1}^{n_t} \mathbf{b}_k s_k \quad (2)$$

where  $s_k$  are the data symbols that correspond to the  $k$ th selected user,  $\mathbf{b}_k$  is the assigned unit-power beam and the square root term is employed for total power constraint.

Although the beams are orthogonally generated, some of this orthogonality is lost in the propagation channel [30]. Consequently, some interference is generated by each beam on non-intended users. The SNIR formulation for the  $k$ th user that is served by the  $v$ th beam is

$$SNIR_{k,v} = \frac{\frac{1}{n_t} |\mathbf{h}_k \mathbf{b}_k|^2}{\sigma^2 + \sum_{u \neq v} \frac{1}{n_t} |\mathbf{h}_k \mathbf{b}_u|^2} \quad (3)$$

where a uniform power allocation is considered. The numerator is the received power from the desired beam, while the denominator represents the noise plus the interference power from the other beams.

As the number of users  $N$  grows, the AP can search for users in a larger pool, thus increasing the probability of finding a set of  $n_t$  users that do not interfere a lot among themselves [30]. Obviously, having  $N \approx n_t$  results in an interference limited system, but for more practical values, such as  $n_t = 2$  transmit antennas and  $N \geq 10$  users, this scheme is efficient and has been shown to obtain higher performance with respect to single user opportunistic beamforming [31], [32].

The IEEE 802.11n PHY layer specification does not contemplate multuser transmissions, even though it supports beamforming as a means to achieve higher data rates in point-to-point communications. Since the MOB scheme is practically a random beamforming transmission technique, it can be easily implemented within the standard without any further requirements in terms of hardware. The only necessary modification is to set accordingly the values of the beamforming steering matrices defined in the standard in order to form the random orthonormal beams.

#### 4. Multuser MAC schemes

The MOB technique is a low-complexity transmission scheme that can be easily implemented at the PHY layer to provide multuser downlink communications. In a practical system, however, the beamforming scheme must be accompanied by a set of MAC layer functions to collect the necessary feedback information and handle the additional challenges that stem from simultaneous multuser transmissions. This section will present three MAC layer schemes that modify the IEEE 802.11n MAC protocol to account for the demands and restrictions of the MOB technique. The required modifications are easy to implement within the IEEE 802.11n/ac standards and are backward compatible with the legacy single user transmission, in the sense that MOB and legacy users can coexist in the system.

Since the proposed MAC schemes aim to support the MOB transmission technique, they provide a common set of functions, graphically shown in Figure 4. These functions provide a practical MAC layer implementation to complement the three steps of the MOB scheme, namely the generation of the orthonormal beams, the acquisition of CSI feedback and the multiuser downlink transmission. In continuation, it is convenient to first present the common framework that applies to the three proposed schemes before proceeding with their detailed description that will focus on their differences in terms of complexity and efficiency.

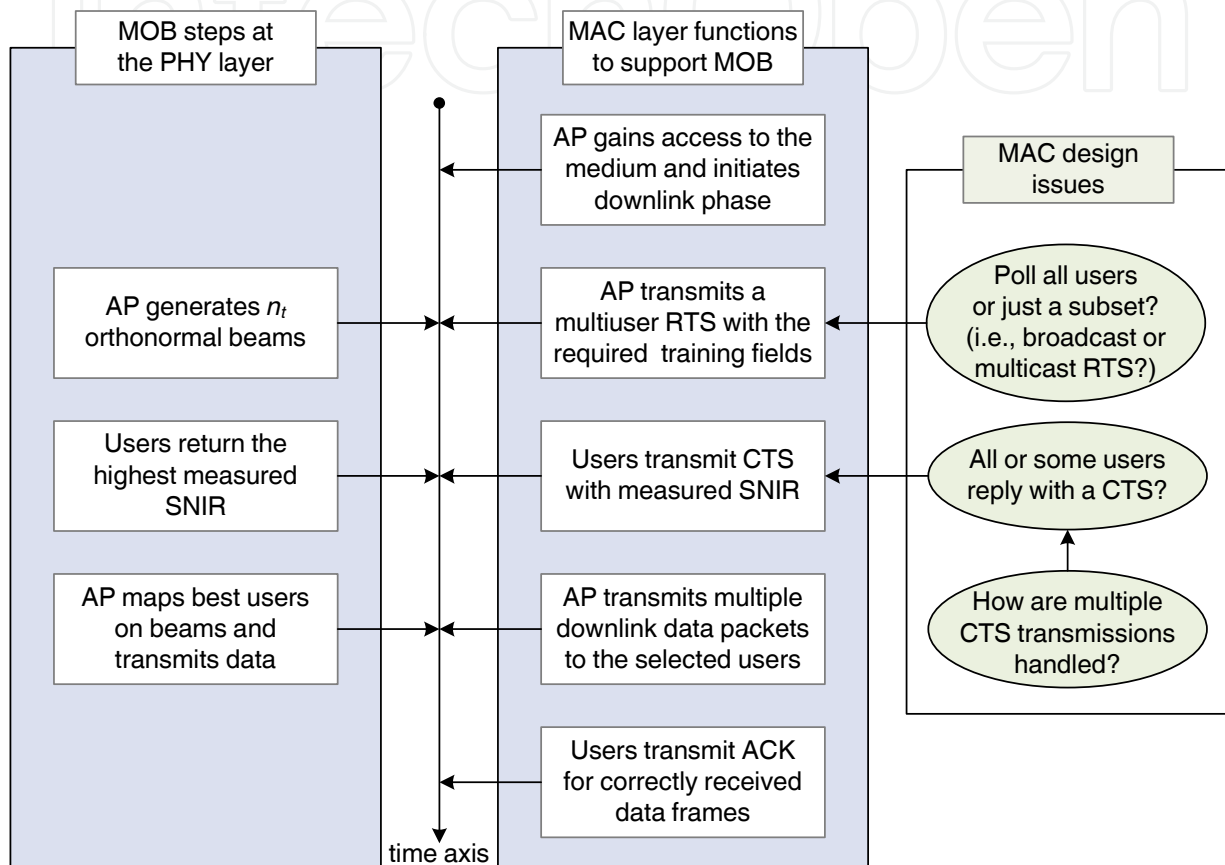

**Figure 4.** MAC layer functions to support the MOB transmission technique

As illustrated in Figure 4, the common functions provided by the MAC layer schemes are:

- *The initiation of the downlink phase.* The proposed multiuser schemes constitute a downlink phase that is always initiated by the AP, so for the sake of simplicity the backoff mechanism defined in the IEEE 802.11 specification is not employed in this study. Generally, in a scenario with both uplink and downlink transmissions, the AP would have to follow the backoff rules to gain access to the medium before initiating the downlink phase.
- *The generation of a multiuser RTS frame.* The initiation of the downlink phase is marked by the transmission of a modified RTS frame that basically serves two purposes:
  1. It is a call for participation in the downlink phase that may be addressed to a subset or to all the associated users (i.e., multicast or broadcast). The employed receiver address

included in the RTS is a point of differentiation between the proposed schemes and will be discussed later in this section.

2. It acts as a sounding frame that will enable the receiving users to measure the SNIR on each of the  $n_t$  generated beams. For this reason, the PHY layer preamble of the RTS contains a number of HT-LTFs (High-Throughput Long Training Fields), as defined in IEEE 802.11n standard. Apart from the training fields, the main body of the RTS frame is transmitted conventionally (i.e., on a single beam).

The structure of the modified RTS frame is shown in Figure 5. The length of the PHY layer preamble of the RTS frame is determined by the number  $n_t$  of spatial streams (i.e., orthonormal beams and subsequently antennas). For a single-antenna transmission, a PHY layer header of  $28 \mu\text{s}$  is introduced, whereas for every additional spatial stream an extra HT-LTF of  $4 \mu\text{s}$  is required. The description of the PHY header fields is given in Table 1 and more details can be found in the IEEE 802.11n specification [2].<sup>1</sup> The length of the MAC header mainly depends on the receiver address field. When a single receiver address is employed, the MAC header has a length of 20 bytes. Nevertheless, some of the proposed MAC schemes include multiple destinations in this address field, as it will be further clarified later.

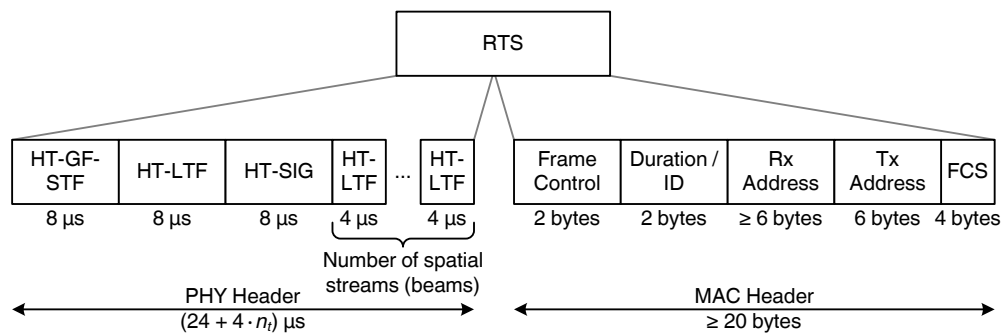

Figure 5. Structure of the modified RTS frame

Element	Description
HT-GF-STF	High-Throughput (HT) Greenfield Short Training Field
HT-LTF1	First HT Long Training Field
HT-SIG	HT SIGNAL Field
HT-LTF	HT Long Training Field

Table 1. Elements of the PHY layer header for the Multuser MAC schemes

- *The transmission of a CTS frame by the downlink users.* Once the users receive the RTS frame and estimate their channel quality, they reply with a CTS frame that, unless otherwise stated, contains the best measured SNIR value and an integer identifier that corresponds to the respective beam. The structure of the modified CTS frame is shown in Figure 6. Assuming single-antenna users, a  $28 \mu\text{s}$  PHY layer preamble is required,

<sup>1</sup> The PHY layer header structure presented in this section has been based on the IEEE 802.11n greenfield operation mode meant for IEEE 802.11n-only compatible stations. If compatibility with legacy devices is desired, the PHY layer headers should be modified accordingly, as indicated in Clause 20 of the IEEE 802.11n specification [2].

whereas the MAC header complies with the IEEE 802.11n specification, with the addition of an extra 1-byte field that contains the CSI information (i.e., the SNIR and the beam identifier).<sup>2</sup> Two design issues arise at this point. The first is whether a CTS should be transmitted by every polled user, or a limit should be posed to the number of CTS replies, for example by filtering out users with very bad channel conditions. The second issue concerns the transmission order of the CTS frames by the multiple users which can be either deterministic, thus collision-free, or random (probabilistic) that will likely result to collisions among simultaneously transmitted CTS. These two issues will be handled in different ways by the proposed MAC schemes, as it will be discussed later.

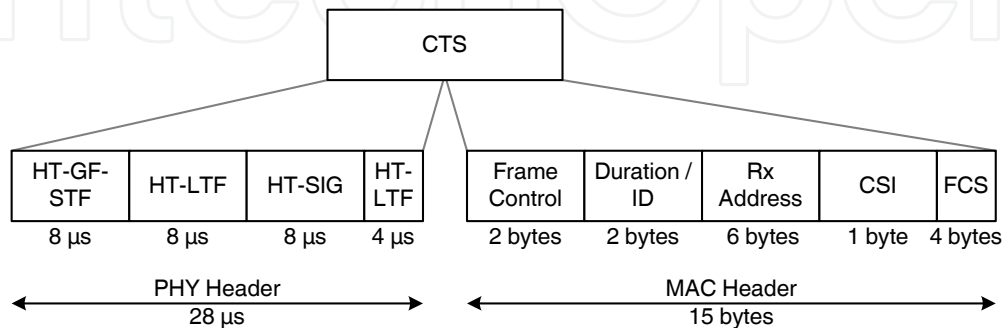

**Figure 6.** Structure of the modified CTS frame, including CSI feedback

- *The transmission of multiuser data frames by the AP.* Once the AP collects the feedback information included in the CTS frames it assigns the user with the highest measured SNIR on each beam (at most one user per beam) and transmits a maximum of  $n_t$  data packets simultaneously. The data packets employ the channel over the same time, frequency and code but are transmitted over different beams. This can be supported by the IEEE 802.11n standard, by exploiting the multiplexing capabilities of multi-antenna systems. This is actually an important shift from current systems where the simultaneous transmission of multiple packets in the same medium leads to collision and packet loss. Link adaptation is also employed and the transmission rate on each beam is determined by the measured SNIR.
- *The transmission of ACK frames.* The users signal the correct reception of a data frame by transmitting an ACK. In the proposed schemes, the multiple (up to  $n_t$ ) ACK frames are transmitted sequentially, following the mapping of the users onto the beams.

In the remaining part of this section, the three proposed MAC layer schemes will be described in detail.

#### 4.1. Mu-Basic scheme

The first and simplest scheme is called *Mu-Basic* and is a straightforward adaptation of the IEEE 802.11 mechanism to support downlink multiuser transmission. This scheme is based on the principle that at most  $n_t$  users can be served simultaneously by an AP equipped with  $n_t$  transmitting antennas that generate an equal number of orthogonal beams. Hence, in the

<sup>2</sup> In this work, it has been assumed that a SNIR quantization scheme has been employed so that the CSI field can be sufficiently represented by 1 byte.

beginning of the transmission sequence, the AP randomly selects  $n_t$  users from the downlink message buffer and transmits a multidestination RTS frame that includes the respective  $n_t$  receiver addresses, as illustrated in Figure 7.

The figure focuses on the receiver address field, since the remaining part of the RTS frame follows the structure indicated previously (Figure 5). The order in which the addresses are listed serves two purposes. First, it indicates the order in which CTS frames are to be sent in order to avoid collisions. Second, the address list is used to implicitly map the polled users to the beams. The users that receive the RTS frame check whether their address is in the list and wait for a predefined time before sending a CTS, which includes the SNIR measurement that corresponds to the assigned beam.<sup>3</sup> Note that in this case, the users do not reply with the best SNIR value since the beam assignment is predefined by the AP.

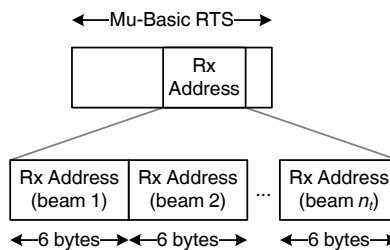

**Figure 7.** The modified RTS frame for the Mu-Basic scheme

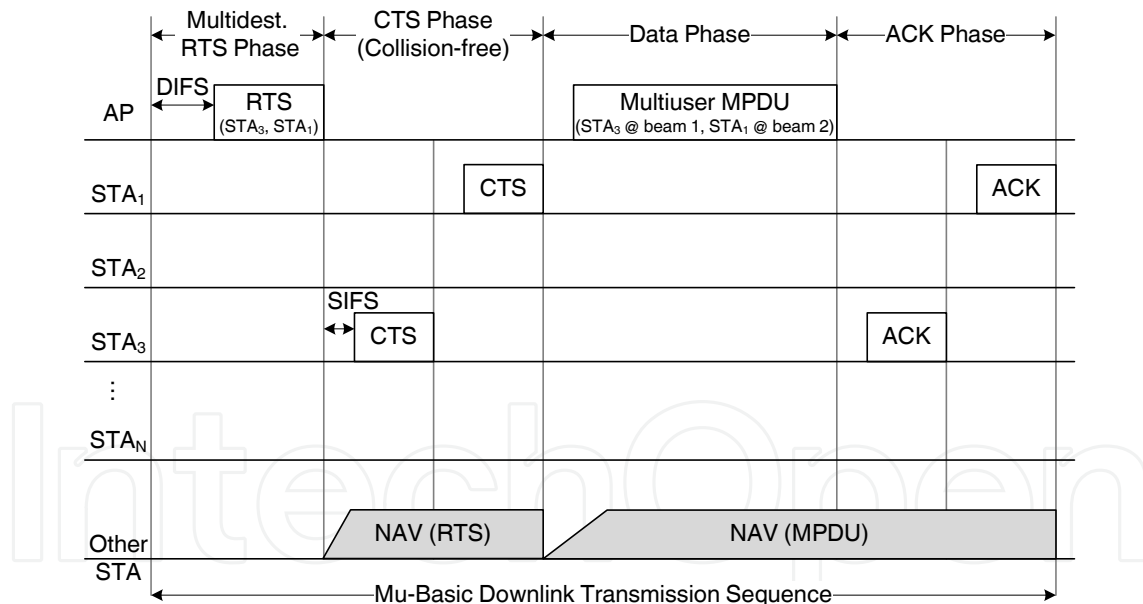

**Figure 8.** Transmission sequence example for the Mu-Basic scheme

The AP proceeds to the simultaneous transmission of the  $n_t$  data packets after selecting the transmission rate for each beam, according to the corresponding SNIR measurement that indicates the link quality. The users acknowledge the data reception by sequentially sending

<sup>3</sup> Since each CTS slot is of a fixed duration (i.e., a SIFS time and the time required for the transmission of the 15 byte CTS with the minimum available transmission rate) and assuming negligible propagation delays, each user can determine when to initiate the CTS transmission.

an ACK frame. An example of the transmission sequence according to the Mu-Basic scheme is given in Figure 8. In this example, there are  $n_t = 2$  antennas at the AP, so two users are randomly selected for transmission (STA<sub>3</sub> and STA<sub>1</sub>).

To avoid collisions by users that do not participate in the process, the IEEE 802.11 NAV mechanism can be employed. For this reason, the time from the transmission of the RTS until the end of the CTS phase is marked in the duration field of the RTS frame (Figure 5). The remaining time of the frame sequence, from the end of the CTS phase until the transmission of the last ACK, is indicated in the respective duration field of the data packet MAC header. Hence, non-participating users can set their NAV timer upon the RTS reception and can later update it when the header of a data packet is decoded.

Mu-Basic is easy to implement since it is a simple polling scheme initiated by the AP. Its performance will serve as a benchmark for the evaluation of the two more advanced multiuser schemes that will be presented next. In the considered case the destination users are randomly selected, however different criteria could also be applied to prioritize users with specific demands (e.g., with delay sensitive applications). Mu-Basic requires some additional overhead in the RTS frame as multiple receiver addresses must be included, but has the shortest possible CTS phase, since the number of received CTS frames is equal to the  $n_t$  served users (it would not make sense to receive feedback from less than  $n_t$  users if all the parallel streams were to be employed). On the other hand, multiuser diversity is not exploited since the users are scheduled without any consideration of their channel quality. Thus, the user selection and the beam assignment processes are not optimally done. As a result, the interference among the scheduled set of users may be high, leading to transmissions at low data rates (i.e. interference controlled system).

## 4.2. Mu-Opportunistic scheme

In an effort to exploit multiuser diversity and transmit opportunistically to the best set of users, according to the principles of the MOB transmission technique, the *Mu-opportunistic* scheme has been proposed. This scheme provides a mechanism for the AP to acquire the CSI of all users before reaching a scheduling decision, in order to optimize user selection and beam allocation. To this end, in the beginning of the transmission sequence, the AP polls all users with available data for downlink transmission. For the sake of simplicity, it will be assumed that the system is under saturation and there is always downlink traffic for each of the  $N$  system users.<sup>4</sup> Hence, the AP transmits a multidestination RTS frame that includes the  $N$  receiver addresses of all the network, as illustrated in Figure 9.

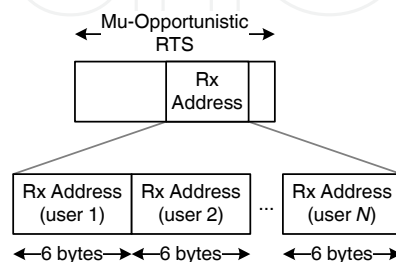

**Figure 9.** The modified RTS frame for the Mu-Opportunistic scheme

<sup>4</sup> The non saturation case will be examined later in this chapter.

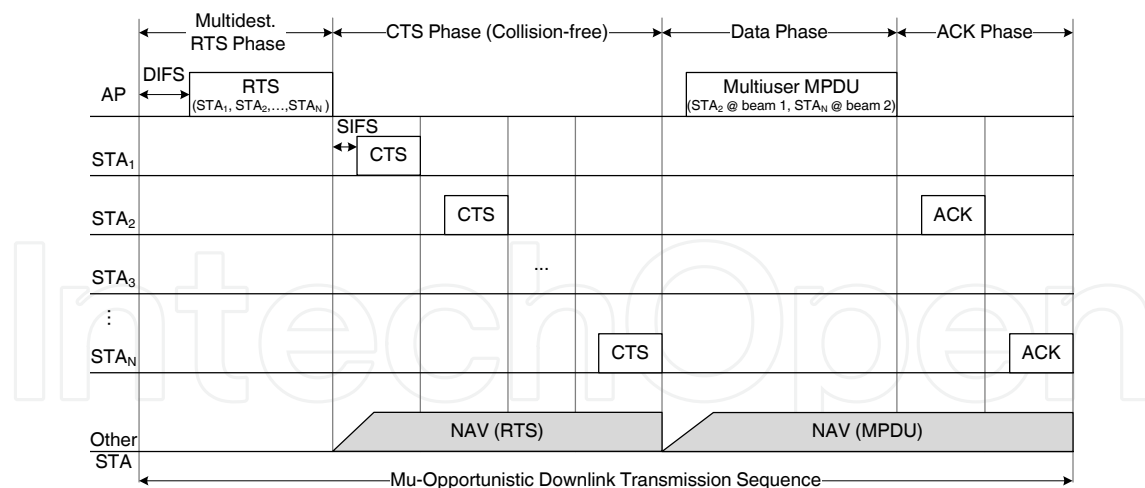

**Figure 10.** Transmission sequence example for the Mu-Opportunistic scheme

The users measure the SNIR on all the beams and include the maximum SNIR value in the CTS, along with an integer identifier of the beam that yielded that value. As before, CTS packets are transmitted in a collision-free manner, following the order of the address list in the RTS. After receiving all the feedback, the AP assigns each beam to the user with the highest SNIR and proceeds to the downlink data transmission. If a beam is not selected by any user then it is not used for transmission, even though this is not likely to happen very often for a large number of active users and a time-varying channel. Correct data reception is marked by the transmission of ACK frames that are sent sequentially, according to the beam allocation order (the user served on the first beam replies first, and so on). An example of the transmission sequence according to the Mu-Opportunistic scheme is given in Figure 10. In this example, there are  $n_t = 2$  antennas at the AP and  $N$  users with available data. The AP receives  $N$  CTS frames and then selects the best set of users ( $STA_2$  and  $STA_N$ , in the example) for the downlink data transmission.

The Mu-Opportunistic fully exploits multiuser diversity since it opportunistically schedules users with good channel conditions and with low mutual interference (i.e., users with high SNIR values measured on different beams). The weakness of this scheme is that it introduces significant overhead, mainly due to the long CTS phase, and the trade-off between overhead and efficiency becomes critical, especially as the number of users  $N$  grows.

### 4.3. Mu-Threshold scheme

The Multiuser Threshold-Selective algorithm (*Mu-Threshold*) is the third proposed multiuser MAC layer scheme. It maintains the opportunistic scheduling policy of selecting a set of users with high rates and low mutual interference but also aims to limit the additional control overhead. In order to achieve these objectives, it introduces two major changes with respect to the Mu-Opportunistic scheme:

- Instead of the deterministic, collision-free CTS transmissions, Mu-Threshold introduces a CTS contention phase during which users compete with each other within a predefined number of slots. Generally, even though collisions among CTS frames are likely to occur, the number of slots is smaller than the total number of users, thus reducing the length of the CTS phase.



- In order to reduce the CTS collision probability, the algorithm imposes a SNIR threshold so that only users with a relatively good channel are allowed to participate in the feedback process. Even though the idea of threshold application is not new, the novelty lies in the inclusion of this concept in a feasible MAC scheme for a multiuser MIMO scenario.

The frame exchange sequence of the Mu-Threshold scheme is initiated with the broadcast transmission of an RTS by the AP. The advantage of this configuration is that it calls all the users to participate in the CTS contention phase by employing a single 6-byte destination address instead of a long address list, as shown in Figure 11. Without doubt, this setup is meaningful under a saturation scenario in which the AP has always packets to transmit to all the associated users. This consideration is made to facilitate the evaluation of the full potential of the Mu-Threshold scheme, given that opportunistic downlink schemes are mostly needed under high-traffic conditions. In non-saturation conditions, the Mu-Threshold scheme could be applied with a minor modification. In this case, the AP would have to periodically set up multicast groups with the subset of active users (i.e., those who are waiting to receive downlink data) and use a multicast instead of a broadcast address.

After the RTS transmission, a CTS contention phase of  $m$  slots is initiated, with  $m$  being a system parameter subject to optimization. The slots have a predefined length, equal to a SIFS duration plus the time required for the transmission of the 15 byte CTS with the minimum available transmission rate. Depending on whether the maximum SNIR measured by a user is above or below the threshold, the user is either allowed to participate in this phase, or forced to remain silent until the beginning of a new frame sequence. Those allowed to participate select randomly a slot with equal probability and transmit a CTS containing the maximum measured SNIR and the corresponding beam identifier. Whenever multiple users select the same slot a collision occurs and the involved CTS frames are considered lost (the capture effect is not considered, even though it could increase the effectiveness of the proposed scheme). A slot can also remain empty if no user selects it for transmission.

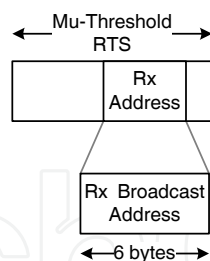

**Figure 11.** The modified RTS frame for the Mu-Threshold scheme

The next stage of the algorithm depends on the outcome of the contention phase. If no CTS has been correctly received (due to either collisions or lack of user participation because of the SNIR threshold value) no data is transmitted and a new contention phase is initiated.<sup>5</sup> User synchronization has been assumed, so that a collision in the  $m$ th slot only affects the involved CTS packets and does not have any effect on transmissions in the remaining slots of the contention phase. Thus, if at least one CTS is received, transmission of downlink data packets can take place. As before, the AP assigns the best user on each beam, based on

<sup>5</sup> Different policies could be implemented to avoid the presence of empty frames (e.g., transmission to a randomly selected user or to a user with a long waiting time using a basic rate) but will not be considered in this work.

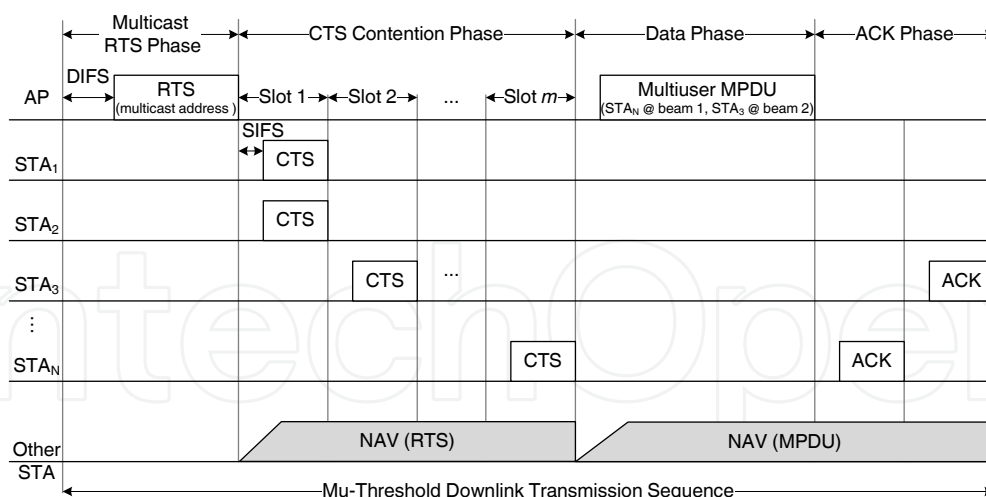

**Figure 12.** Transmission sequence example for the Mu-Threshold scheme

the feedback information collected by the received CTS frames and transmits a maximum of  $n_t$  data packets simultaneously. Note that, unlike the contention phase where collisions among CTS frames can occur, the transmission of data is collision-free. Finally, the users acknowledge the data reception by sequentially sending an ACK frame, following the order of the user mapping onto the beams.

An example of the transmission sequence according to the Mu-Threshold scheme is given in Figure 12. In this example, there are  $n_t = 2$  antennas at the AP and  $N$  users with available data that compete in  $m$  CTS slots (with  $m < N$  in general). Some users may select the same slot and collide (e.g., STA<sub>1</sub> and STA<sub>2</sub>), others may transmit a CTS successfully (e.g. STA<sub>3</sub> and STA<sub>N</sub>) and finally a number of users will refrain from this phase due to their unfavorable channel conditions.

An important decision is the selection of the SNIR threshold that serves two purposes: it reduces the number of contending users, thus decreasing the probability of CTS collisions, and it filters out those users with harsh channel condition, resulting to transmissions with higher data rates. Nevertheless, selecting a high threshold could cause adverse effects such as starvation if the majority of users experience low link quality. The threshold is determined by the AP and it is made known to the users during an initial association phase (alternatively, it could be included in the RTS packet, thus increasing its size by a few overhead bits). It is also possible to design a dynamic scheme that will adapt the threshold value at runtime depending on measured channel statistics.

The number of the CTS contention slots  $m$  is another important parameter that depends on the number of participating users which, in turn, is determined by the total number of users  $N$ , their channel condition and the selected threshold. An interesting observation is that, since the duration of each CTS slot is fixed, the duration field of the RTS packet (that indicates the length of the CTS phase) implicitly reveals the number of contention slots  $m$ . Therefore, the AP can let the users know the value of  $m$  without requiring an additional control field.

## 5. Performance evaluation

### 5.1. Simulation setup

This section will focus on the performance evaluation of the proposed multiuser schemes. Simulation results have been obtained with the help of a custom-made link layer simulation tool implemented in C++. Theoretical analysis of the proposed schemes has also been derived and more details can be found in [33].

The simulation setup considers an infrastructure downlink network that consists of an AP with  $n_t = 2$  transmitting antennas and  $N = 10$  single-antenna users (MISO scenario). An ideal Adaptive Modulation and Coding (AMC) that ensures error-free data transmission has been assumed at the PHY layer, given that the rate for each transmission is selected according to the link quality, as expressed by the SNIR.

A channel model that represents the IEEE 802.11n channel model B in Non-line-of-sight (NLOS) conditions has been considered [29]. As mentioned in Section 3.2, a block-fading model with independent and identically distributed complex Gaussian entries  $\sim \mathcal{CN}(0,1)$  has been considered, with a noise variance of 0.1.<sup>6</sup> Each block corresponds to the duration of a frame sequence and no correlations have been assumed among the different blocks. This model has been employed to generate a SNIR matrix that represents the channel condition of each user on a frame-by-frame basis. The SNIR limits employed to determine the available transmission rate of each user are given in Table 2 [34].

Rate (Mbps)	SNIR (dB)
0 (no transmission)	$\leq -8$
6	-8 to 12.5
9	12.5 to 14
12	14 to 16.5
18	16.5 to 19
24	19 to 22.5
36	22.5 to 26
48	26 to 28
54	$>28$

**Table 2.** SNIR thresholds

Four different scenarios have been considered, characterized by four channel implementations (i.e., different SNIR matrices) denoted by  $Ch_A$ ,  $Ch_B$ ,  $Ch_C$  and  $Ch_D$ . The average link quality varies for each channel, with  $Ch_A$  corresponding to the most unfavorable conditions and  $Ch_D$  representing a channel with high quality links. For reference, the average user SNIR for channels  $Ch_A$  to  $Ch_D$  is 15dB, 17dB, 20dB and 25dB, respectively. According to Table 2, the average user rate for each scenario will be 12, 18, 24, and 36 Mbps, respectively. Since the channel realizations are random, the available rate for each user at every time

<sup>6</sup> Without loss of generality, a relatively low noise variance has been used. Higher values would lead to different numerical results but without affecting the behavior of the evaluated MAC schemes.

instance will oscillate around the mean value (with the same variance for all users), through the block fading channel defined in Section 3.2.

Parameter	Value
Number of antennas (AP)	$n_t = 2$
Number of antennas (Users)	$n_r = 1$
Downlink Users	$N = 10$
SIFS	$16 \mu s$
aSlotTime	$9 \mu s$
PHY Header (AP)	$28 \mu s$
PHY Header (Users)	$32 \mu s$
MAC Header	40 bytes
RTS (Mu-Basic)	$14 + 6 \cdot n_t$ bytes
RTS (Mu-Opportunistic)	$14 + 6 \cdot N$ bytes
RTS (Mu-Threshold)	20 bytes
CTS	15 bytes
DATA	2312 bytes
ACK	14 bytes
Bandwidth	20 MHz

**Table 3.** Simulation parameters

Saturated traffic conditions have been considered, with a constant flow of downlink traffic for all users always available at the buffers of the AP. The rationale behind this assumption has been to evaluate the maximum gain that can be extracted from downlink transmissions, which requires the system to operate under heavy traffic load. Unless otherwise stated, the size of the data packets has been fixed to 2312 bytes. All control frames are transmitted at the lowest rate (i.e., at 6 Mbps) to ensure correct reception. The IEEE 802.11n frame format has been adopted at the MAC layer, with the modifications proposed in Section 4 for each multiuser scheme. A summary of the simulation parameters is given in Table 3.

## 5.2. Performance comparison of the multiuser schemes

This section compares the performance achieved by the proposed multiuser MAC schemes, Mu-Basic, Mu-Opportunistic and Mu-Threshold. Figures 13 and 14 plot the throughput and mean total delay performance for the four channel models,  $N = 10$  users and a packet size of  $L = 2312$  bytes. The performance of the non-realistic Mu-Ideal scheme is also depicted, as a reference of the upper bound that corresponds to the considered scenarios. Mu-Ideal is an ideal opportunistic multiuser scheme in which the users with the highest SNIR values are scheduled on each beam. In other words, the same scheduling objective as in the Mu-Opportunistic scheme (Section 4.2) is targeted. The difference is that, in the Mu-Ideal scheme it has been assumed that the AP has a perfect knowledge of the channel condition and can select the best set of users without any additional overhead. Clearly, this scheme is not practical, since some mechanism for the CSI acquisition must be available at the AP.

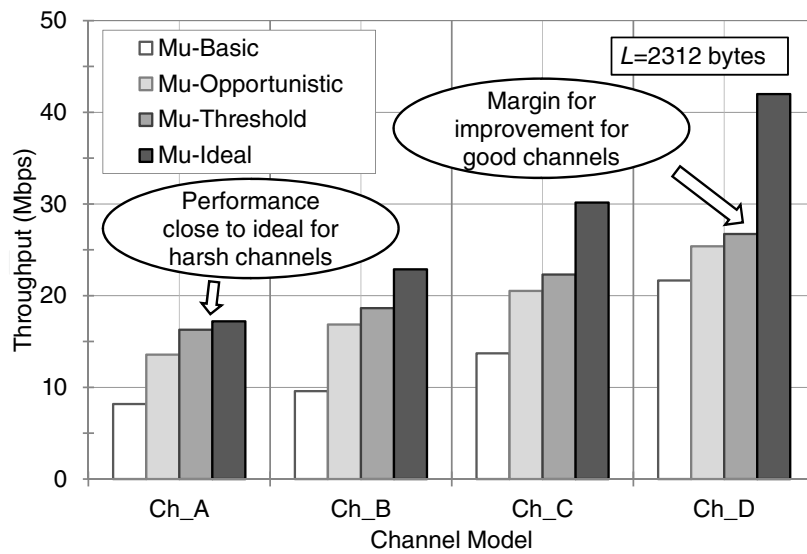

Figure 13. Throughput performance comparison

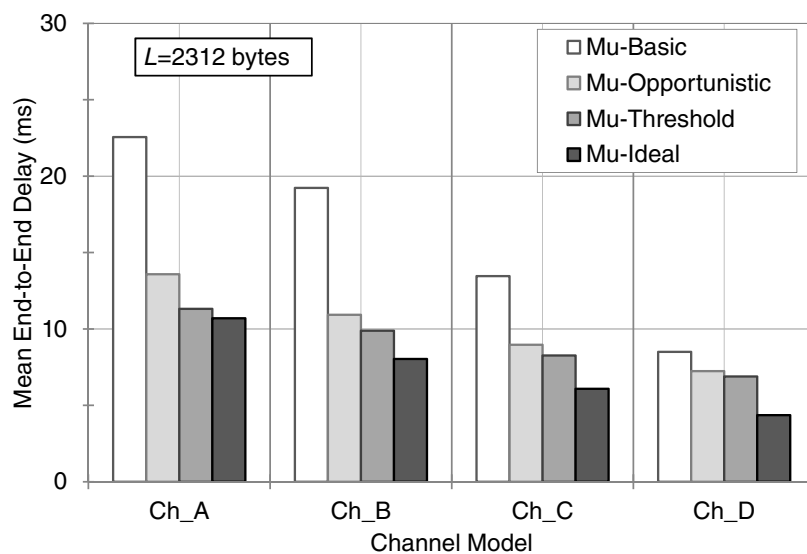

Figure 14. End-to-End delay performance comparison

The presented results for the Mu-Threshold have been obtained by considering the best combination of threshold and CTS slot number values. These optimum parameters are summarized in Table 4. In general, the channel statistics influence heavily the Mu-Threshold performance and the optimization of the algorithm is not straightforward since different objectives must be met to maximize performance in diverse scenarios. This can be better understood by examining the percentage of empty frames, given in the last column of the table. In the case of  $Ch_D$ , this percentage is low, meaning that the majority of frames feature single or double data transmissions. On the other hand, for harsh channels the minislot-threshold combination that maximizes throughput may result to a higher number of empty frames (even up to 50% for  $Ch_A$ ), thus revealing that it is more efficient, as far as

throughput is concerned, to transmit fewer packets but with a higher rate than to transmit in every transmit sequence with lower rates.

Channel	Threshold	Slots	Empty Frames
	$r_\gamma$	$m$	%
$Ch_A$	24	2	49.9
$Ch_B$	24	3	29.2
$Ch_C$	36	3	30.7
$Ch_D$	48	3	23.9

**Table 4.** Best configuration for Mu-Threshold scheme

The performance of the two opportunistic schemes, Mu-Opportunistic and Mu-Threshold, is bound between Mu-Basic and Mu-Ideal schemes. To illustrate this point, two performance statistics have been calculated in Table 5. The first metric reflects the throughput gain of the two schemes with respect to the Mu-Basic algorithm. It can be observed that both schemes improve performance under all the considered channel models by scheduling users with high available transmission rates. However, the exact value of the achieved gain depends on the channel quality. For harsh channels, the improvement is more pronounced. In the case of  $Ch_A$ , for instance, a gain of approximately 66 % and 99 % is obtained by Mu-Opportunistic and Mu-Threshold, respectively. On the other hand, when the channel quality is good, as in  $Ch_D$ , the need for opportunistic scheduling is less critical. Nevertheless, even in that case, an enhancement of more than 20 % can be achieved.

Channel	Throughput gain (%)		Improvement margin (%)	
	with respect to Mu-Basic		with respect to Mu-Ideal	
	Mu-Opport.	Mu-Thres.	Mu-Opport.	Mu-Thres.
$Ch_A$	65.84	99.21	26.80	5.56
$Ch_B$	75.76	94.36	35.64	22.66
$Ch_C$	49.67	62.69	47.03	35.25
$Ch_D$	17.25	23.47	65.45	57.11

**Table 5.** Performance statistics for the proposed multuser schemes

Mu-Opportunistic and Mu-Threshold are two efficient multuser schemes but there is still a margin for improvement in order to achieve the upper bound set by the Mu-Ideal. The second metric presented in Table 5 refers to the available improvement margin. The three schemes share the principle of opportunistic scheduling, but implement it in different ways. Mu-Ideal assumes perfect CSI knowledge without any additional overhead cost, which is an assumption that does not hold for realistic schemes. Mu-Opportunistic introduces considerable overhead since  $N = 10$  CTS packets are sent in each transmission sequence. Finally, Mu-Threshold manages to reduce overhead by employing  $m$  control slots, with  $m$  usually much smaller than the number of total users  $N$  (in the presented example, the best

performance throughput has been obtained for no more than  $m = 3$  slots). As a result, Mu-Threshold is closer to the Mu-Ideal.

Another interesting observation is that the two practical schemes are closer to the ideal under worse channel conditions. In the case of  $Ch_A$ , for instance, the improvement margin is 26.8 % for Mu-Opportunistic and only 5.6 % for Mu-Threshold (less than 1 Mbps below the upper throughput bound). The gap between the achieved throughput and the ideal performance opens as the channel conditions improve and in the case of  $Ch_D$  both schemes have an improvement margin of more than 50 %. This occurs because the overhead information, consisting of control packets transmitted at the lowest rate, has a greater impact on performance when high data rates are employed.

Table 6 gives an estimation of the improvement achieved by exploiting the multiuser diversity. This gain is reflected in the increase of the average data transmission rate compared to the average user rate for each channel model. The average data transmission rate is calculated as the average of the rates employed for the transmission of all data frames. The average user rate is obtained by calculating the average value of the maximum rate at which a user can transmit, if the best beam (i.e., with the higher SNIR) for the particular user is selected. This value depends on the channel model and is indicated in the second column of the table.

Channel	Avg. User	Avg. Tx Rate (Mbps)			
	Rate (Mbps)	Mu-Basic	Mu-Opport.	Mu-Thres.	Mu-Ideal
$Ch_A$	12	9.73	18.77	27.60	18.77
$Ch_B$	18	14.37	23.76	30.48	23.76
$Ch_C$	24	19.01	34.46	44.40	34.46
$Ch_D$	36	32.41	46.73	51.64	46.73

**Table 6.** Multiuser diversity gain

In the case of Mu-Basic, the average transmission rate is lower than the average user rate. This is a direct consequence of random scheduling and beam allocation: users may be selected for transmission when their channel quality is low, or they may receive increased interference from other simultaneous transmissions due to the suboptimal beam allocation. Mu-Opportunistic, on the other hand, exploits multiuser diversity by assigning the best user on every beam. As a result, most transmissions take place at rates above the average. In the case of  $Ch_D$ , for instance, the transmission rate is 46.7 Mbps whereas the average user rate is limited to 36 Mbps. It should be noted that Mu-Opportunistic yields the same average transmission rate as the Mu-Ideal scheme, since both schemes implement the same scheduling policy. Despite providing the same transmission rate, the throughput performance of Mu-Opportunistic is lower than the ideal, due to the additional control overhead required for the CSI acquisition.

Finally, the maximum transmission rate values are achieved by Mu-Threshold. At first glance, it seems puzzling to obtain rates above those of the Mu-Ideal scheme. Nevertheless, this can be explained with the help of the data presented in Table 4. By imposing a rate threshold, Mu-Threshold scheme controls the minimum rate that can be employed for transmission.

For instance, in the case of  $Ch_D$ , the optimum performance is achieved for a threshold of 48 Mbps, meaning that all transmissions have taken place at the rates of 48 and 54 Mbps, thus increasing the average transmission rate. On the other hand, since the average user rate for this channel is 36 Mbps, there is a high possibility that users may not satisfy the threshold condition, resulting to empty frames with no data transmissions. For the best configuration of Mu-Threshold for  $Ch_D$ , the percentage of empty frames is approximately 24% of the total frame sequences, as indicated in the last column of Table 4.

So far, a relatively small number of users,  $N = 10$  has been considered. The following set of plots in Figure 15 shows the maximum throughput obtained by Mu-Opportunistic and Mu-Threshold as a function of the number of system users  $N$  for channel models  $Ch_A$  and  $Ch_D$ . The best configuration for the Mu-Threshold has been considered and the employed values for the slot number and the rate threshold are also indicated in the figure.

In the case of Mu-Opportunistic, throughput decreases as the number of users grows. This is an unavoidable consequence of the control overhead required for the acquisition of CSI by all the system users. The degradation is more pronounced as the channel improves (e.g.,  $Ch_D$ ) and higher rates are employed for the data transmission (but not the overhead that is sent at the lowest supported rate). The lesson learned from this observation is that when multiple users are present, the Mu-Opportunistic mechanism is not very efficient. As a more viable alternative, the AP could divide the users in smaller groups and poll a user subset in each transmission sequence. This would reduce the multiuser gain but would also limit the introduced overhead.

On the other hand, Mu-Threshold handles multiple users in a more efficient way and throughput is actually improved as the user number increases. Several factors affect this behavior. First, when more users are present, the gain extracted from multiuser diversity also increases, since there is a higher probability of assigning a high-user rate on each beam. Second, unlike the Mu-Opportunistic scheme, the control overhead does not increase linearly with  $N$  but depends on the number of CTS slots  $m$ .

The selection of the slot number and the rate threshold provides a flexible mechanism to control the number of participating users in each transmission sequence. The best configuration depends on the channel distribution but generally the following principles hold:

- More slots are required as the number of user grows, to reduce the collision probability in the contention window. By observing the best configuration for each case, marked in Figure 15, it can be said that  $m$  generally follows an increasing trend.
- The collision probability can also be reduced by increasing the rate threshold, which results to a smaller number of participating users (but with higher available rates). Again, as the number of users grows, the threshold is progressively raised.

## 6. Conclusions

This chapter has presented a novel approach for the integration of multiuser capabilities in IEEE 802.11n/ac based WLANs. On one hand, a low-complexity beamforming technique named MOB has been employed at the PHY layer. The main strength of MOB lies in the



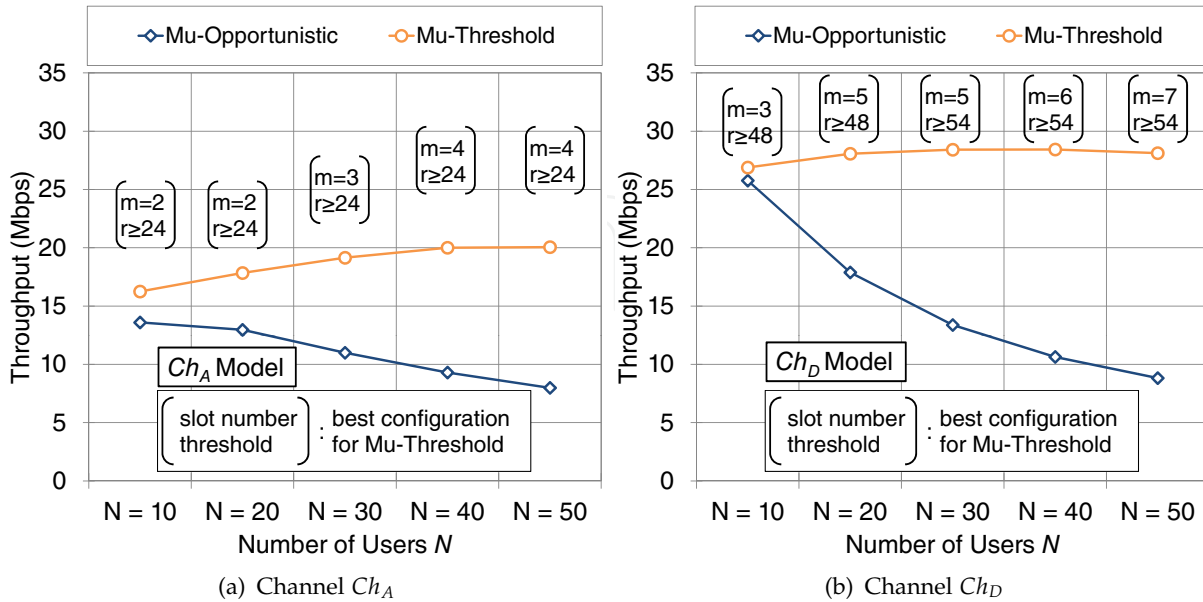

Figure 15. Throughput performance comparison versus the number of users

fact that it only requires partial CSI information at the transmitter side, in the form of SNIR measurements acquired by the downlink users. Since the IEEE 802.11n/ac specifications support beamforming, MOB can be easily implemented with minor modifications in the beamforming steering matrices.

On the other hand, in order to exploit the potential of the MOB technique in a realistic scenario, it is necessary to design appropriate MAC layer mechanisms to handle multiuser transmissions. In this chapter, three MAC layer schemes have been proposed. The first scheme, Mu-Basic, implemented a simple random scheduling multiuser scheme, meant to serve as a performance reference. Then, two opportunistic schemes have been proposed, Mu-Opportunistic and Mu-Threshold, that enhance performance by extracting the multiuser diversity gain.

The performance evaluation of the proposed multiuser schemes has led to many interesting observations. The lessons learned can be employed to improve the proposed algorithms but also as more general guidelines in the design of multiuser MAC schemes. The more remarkable conclusions are summarized as follows:

- When the best set of users is opportunistically selected depending on their measured channel quality, the gain achieved by multiuser transmissions can be significant.
- Multiuser diversity gain increases with the number of system users, since there is a higher probability of finding a high-rate set of users among a larger user pool. On the other hand, more users come with a cost of additional control overhead for the CSI acquisition. Mu-Threshold handles efficiently multiple users by setting appropriately the slot number

and the rate threshold parameters. In the case of Mu-Opportunistic scheme, the control overhead increases linearly with the user number and performance eventually drops.

- Under harsh channels, the performance of the proposed multiuser schemes approaches the upper performance bound set by the ideal case of having perfect CSI knowledge with no additional overhead. On the other hand, under more favorable channel conditions, there is still a margin for potential improvement by exploiting multiuser transmissions.

## Acknowledgements

This work has been funded by the Research Projects GREENET (PITN-GA-2010-264759), CO2GREEN (TEC2010-20823), Green-T (CP8-006) and GEOCOM (TEC2011-27723-C02-01).

## Author details

Elli Kartsakli<sup>1,\*</sup>, Nizar Zorba<sup>1</sup>, Luis Alonso<sup>2</sup> and Christos Verikoukis<sup>3</sup>

\* Address all correspondence to: [ellik@tsc.upc.edu](mailto:ellik@tsc.upc.edu)

1 Signal Theory and Communications Department of Technical University of Catalunya (UPC), Barcelona, Spain

2 Electrical Engineering Department of The University of Jordan, Jordan

3 Telecommunications Technological Center of Catalunya (CTTC), Barcelona, Spain

## References

- [1] IEEE Standard for Information technology – Telecommunications and information exchange between systems – Local and metropolitan area networks – Specific requirements – Part 11: Wireless LAN Medium Access Control (MAC) and Physical Layer (PHY) specifications. *IEEE Std 802.11-2007 (Rev. of IEEE Std 802.11-1999)*, December 2007.
- [2] IEEE Standard for Information Technology – Telecommunications and information exchange between systems – Local and metropolitan area networks – Specific requirements Part 11: Wireless LAN Medium Access Control (MAC) and Physical Layer (PHY) specifications Amendment 5: Enhancements for Higher Throughput. *IEEE Std 802.11n-2009*, pages c1–502, October 2009.
- [3] G. Caire and S. Shamai. On the achievable throughput of a multiantenna Gaussian broadcast channel. *IEEE Transactions on Information Theory*, 49(7):1691–1706, July 2003.
- [4] M.Z. Siam and M. Krunz. An overview of MIMO-oriented channel access in wireless networks [medium access control protocols for wireless LANs]. *IEEE Wireless Communications Magazine*, 15(1):63–69, February 2008.
- [5] Per H. Lehne and Magne Pettersen. An Overview of Smart Antenna Technology for Mobile Communications Systems. *IEEE Communication Surveys & Tutorials*, 2(4):2–13, 4th Quarter 1999.

- [6] M. Zorzi, J. Zeidler, A. Anderson, B. Rao, J. Proakis, A.L. Swindlehurst, M. Jensen, and S. Krishnamurthy. Cross-layer issues in MAC protocol design for MIMO ad hoc networks. *IEEE Wireless Communications Magazine*, 13(4):62 – 76, August 2006.
- [7] D. Gesbert, M. Shafi, Da shan Shiu, P.J. Smith, and A. Naguib. From theory to practice: an overview of MIMO space-time coded wireless systems. *IEEE Journal on Selected Areas in Communications*, 21(3):281–302, April 2003.
- [8] W. C. Jakes. *Microwave Mobile Communications*. Wiley and Sons, New York, NY, 1974.
- [9] N. Seshadri and J.H. Winters. Two signaling schemes for improving the error performance of frequency-division-duplex (FDD) transmission systems using transmitter antenna diversity. In *Proc. of IEEE 43rd Vehicular Technology Conference (VTC 1993)*, pages 508 – 511, May 1993.
- [10] A. Wittneben. Basestation modulation diversity for digital simulcast. In *Proc. of IEEE 41th Vehicular Technology Conference (VTC 1991)*, pages 848–853, May 1991.
- [11] A. Wittneben. A new bandwidth efficient transmit antenna modulation diversity scheme for linear digital modulation. In *Proc. of IEEE International Conference on Communications (ICC 1993)*, pages 1630 – 1634 vol.3, May 1993.
- [12] S.M. Alamouti. A simple transmit diversity technique for wireless communications. *IEEE Journal on Selected Areas in Communications*, 16(8):1451–1458, October 1998.
- [13] V. Tarokh, N. Seshadri, and A.R. Calderbank. Space-time codes for high data rate wireless communication: Performance criterion and code construction. *IEEE Transactions on Information Theory*, 44(2):744–765, March 1998.
- [14] V. Tarokh, H. Jafarkhani, and A.R. Calderbank. Space-time block codes from orthogonal designs. *IEEE Transactions on Information Theory*, 45(5):1456 – 1467, July 1999.
- [15] P.W. Wolniansky, G.J. Foschini, G.D. Golden, and R.A. Valenzuela. V-BLAST: an architecture for realizing very high data rates over the rich-scattering wireless channel. In *URSI International Symposium on Signals, Systems, and Electronics (ISSSE 1998)*, pages 295–300, September 1998.
- [16] A.J. Paulraj and C.B. Papadias. Space-time processing for wireless communications. *IEEE Signal Processing Magazine*, 14(6):49–83, November 1997.
- [17] Lihong Zheng and D.N.C. Tse. Diversity and multiplexing: a fundamental tradeoff in multiple-antenna channels. *IEEE Transactions on Information Theory*, 49(5):1073 – 1096, May 2003.
- [18] D.N.C. Tse, P. Viswanath, and Lihong Zheng. Diversity-multiplexing tradeoff in multiple-access channels. *IEEE Transactions on Information Theory*, 50(9):1859–1874, September 2004.

- [19] C. Anton-Haro, P. Svedman, M. Bengtsson, A. Alexiou, and A. Gameiro. Cross-layer scheduling for multi-user MIMO systems. *IEEE Communications Magazine*, 44(9):39–45, September 2006.
- [20] A.S. Macedo and E.S. Sousa. Antenna-sector time-division multiple access for broadband indoor wireless systems. *IEEE Journal on Selected Areas in Communications*, 16(6):937–952, August 1998.
- [21] Hujun Yin and Hui Liu. Performance of space-division multiple-access (SDMA) with scheduling. *IEEE Transactions on Wireless Communications*, 1(4):611–618, October 2002.
- [22] D. Gesbert and M.-S. Alouini. How much feedback is multi-user diversity really worth? In *Proc. of IEEE International Conference on Communications (ICC 2004)*, pages 234–238, June 2004.
- [23] S. Sanayei and A. Nosratinia. Opportunistic Downlink Transmission With Limited Feedback. *IEEE Transactions on Information Theory*, 53(11):4363–4372, November 2007.
- [24] Xiangping Qin and R. Berry. Opportunistic splitting algorithms for wireless networks. In *Proc. of the 23rd Annual Joint Conference of the IEEE Computer and Communications Societies (INFOCOM 2004)*, pages 1662–1672, vol.3, 2004.
- [25] V. Shah, N.B. Mehta, and R. Yim. Analysis, Insights and Generalization of a Fast Decentralized Relay Selection Mechanism. In *Proc. of IEEE International Conference on Communications (ICC 2009)*, pages 1–6, June 2009.
- [26] J. Mirkovic, Jing Zhao, and D. Denteneer. A MAC Protocol with Multi-User MIMO Support for Ad-Hoc WLANs. In *Proc. of IEEE 18th International Symposium on Personal, Indoor and Mobile Radio Communications (PIMRC 2007)*, pages 1–5, September 2007.
- [27] Young-June Choi, Neung-Hyung Lee, and Saewoong Bahk. Exploiting Multuser MIMO in the IEEE 802.11 Wireless LAN Systems. *Wireless Personal Communications*, 54(3):385–396, August 2008.
- [28] V. Shah, N.B. Mehta, and R. Yim. MAC enhancements for downlink multi-user MIMO transmission in next generation WLAN. In *Proc. of IEEE Consumer Communications and Networking Conference (CCNC 2012)*, pages 832–837, January 2012.
- [29] IEEE 802 11-03/161r2. TGn Indoor MIMO WLAN Channel Models, 2004.
- [30] M. Sharif and B. Hassibi. On the capacity of MIMO broadcast channels with partial side information. *IEEE Transactions on Information Theory*, 51(2):506–522, February 2005.
- [31] Nizar Zorba and A.I. Pérez-Neira. CAC for Multibeam Opportunistic Schemes in Heterogeneous WiMax Systems Under QoS Constraints. In *Proc. of IEEE Global Telecommunications Conference (GLOBECOM 2007)*, pages 4296–4300, November 2007.
- [32] P. Viswanath, D.N.C. Tse, and R. Laroia. Opportunistic beamforming using dumb antennas. *IEEE Transactions on Information Theory*, 48(6):1277–1294, June 2002.

- [33] Elli Kartsakli, Nizar Zorba, Luis Alonso, and Christos Verikoukis. A threshold-selective multiuser downlink mac scheme for 802.11n wireless networks. *IEEE Transactions on Wireless Communications*, 10(3):857–867, March 2011.
- [34] D. Pubill and A.I. Pérez-Neira. Handoff Optimization with Fuzzy Logic in 802.11 Networks. In *Proc. of Conference on Information Processing and Management of Uncertainty in Knowledge-Based Systems (IPMU 2006)*, July 2006.

IntechOpen

IntechOpen