

AN INTRODUCTION TO  
**WASTE  
MANAGEMENT  
AND  
CIRCULAR  
ECONOMY**

STIJN VAN EWIK &  
JULIA STEGEMANN

**UCLPRESS**





# **An Introduction to Waste Management and Circular Economy**



# An Introduction to Waste Management and Circular Economy

Stijn van Ewijk &  
Julia Stegemann

*UCL Press, the UK's first fully open access university press, is investing in an open access textbook programme. Publishing for courses at UCL and for other universities globally, it reflects our commitment to widening the use of open educational resources. The rising cost of textbooks, combined with issues of availability, particularly digitally, are a challenge for universities and a potential barrier to student learning. Open access publishing provides a means to make textbooks accessible to a wider audience, while also reducing the burden on library budgets.*

*If you are using this textbook to teach a course at your institution, please notify us at [uclpresspublishing@ucl.ac.uk](mailto:uclpresspublishing@ucl.ac.uk) so that we can track adoptions and build metrics that evidence how open access textbooks are used and the value they deliver.*





First published in 2023 by  
UCL Press  
University College London  
Gower Street  
London WC1E 6BT

Available to download free: [www.uclpress.co.uk](http://www.uclpress.co.uk)

Text © Authors, 2023  
Images © Authors and copyright holders named in captions, 2023

The authors have asserted their rights under the Copyright, Designs and Patents Act 1988 to be identified as the authors of this work.

A CIP catalogue record for this book is available from The British Library.



Any third-party material in this book is not covered by the book's Creative Commons licence. Details of the copyright ownership and permitted use of third-party material is given in the image (or extract) credit lines. If you would like to reuse any third-party material not covered by the book's Creative Commons licence, you will need to obtain permission directly from the copyright owner.

This book is published under a Creative Commons Attribution-Non-Commercial 4.0 International licence (CC BY-NC 4.0), <https://creativecommons.org/licenses/by-nc/4.0/>. This licence allows you to share and adapt the work for non-commercial use providing attribution is made to the author and publisher (but not in any way that suggests that they endorse you or your use of the work) and any changes are indicated. Attribution should include the following information:

van Ewijk, S. and Stegemann, S. 2023. *An Introduction to Waste Management and Circular Economy*. London: UCL Press.  
<https://doi.org/10.14324/111.9781800084650>

Further details about Creative Commons licences are available at  
<https://creativecommons.org/licenses/>

ISBN: 978-1-80008-466-7 (Pbk.)  
ISBN: 978-1-80008-465-0 (PDF)  
ISBN: 978-1-80008-468-1 (epub)  
DOI: <https://doi.org/10.14324/111.9781800084650>

## **CONTENTS**

<i>Abbreviations</i>	x
<i>SI units and prefixes</i>	xi
<i>List of boxes</i>	xii
<i>List of exercises</i>	xiv
<i>Foreword</i>	xv
<i>Acknowledgements</i>	xvi
1 Materials and waste	2
1.1 Introduction	3
1.2 Drivers of material use	4
1.3 The material lifecycle	9
1.4 Waste generation	14
1.5 Waste management	21
1.6 The challenges of waste	30
1.7 Summary	36
1.8 Review	37
2 The impacts of waste	38
2.1 Introduction	39
2.2 Sustainability and the environment	40
2.3 The environmental impacts of waste	44
2.4 The social impacts of waste	53
2.5 The economics of waste	58
2.6 Summary	62
2.7 Review	63
3 Assessment methods	64
3.1 Introduction	65
3.2 Material flow analysis (MFA)	66
3.3 Lifecycle assessment (LCA)	74
3.4 Other assessment methods	89
3.5 Summary	99
3.6 Review	100
4 Policy and legislation	102
4.1 Introduction	103
4.2 The drivers of waste management	104

4.3	Waste legislation	110
4.4	Policy instruments	118
4.5	The making of policy	126
4.6	Summary	135
4.7	Review	136
5	Waste prevention	138
5.1	Introduction	139
5.2	Overview of waste prevention	140
5.3	Efficient production and manufacturing	144
5.4	Efficient use	149
5.5	Product avoidance	154
5.6	Achieving prevention	157
5.7	Summary	161
5.8	Review	162
6	Collection and treatment	164
6.1	Introduction	165
6.2	Waste collection	166
6.3	Waste treatment	176
6.4	Physical treatment	185
6.5	Physicochemical treatment	195
6.6	Biological treatment	200
6.7	Thermal treatment	208
6.8	Summary	213
6.9	Review	214
7	Waste recycling	216
7.1	Introduction	217
7.2	Recycling overview	218
7.3	Metal recycling	224
7.4	Plastics recycling	231
7.5	Paper recycling	237
7.6	Other materials and products	242
7.7	Summary	253
7.8	Review	254
8	Energy recovery and disposal	256
8.1	Introduction	257
8.2	Waste as a fuel	257



8.3	Municipal solid waste incineration	260
8.4	Anaerobic digestion	272
8.5	Landfill of municipal solid waste	284
8.6	Other types of disposal and recovery	299
8.7	Summary	302
8.8	Review	303
9	The circular economy	306
9.1	Introduction	307
9.2	Sustainability goals	308
9.3	Material circularity	314
9.4	Circular strategies	324
9.5	Achieving circularity	336
9.6	Summary	346
9.7	Review	347
	<i>Further reading</i>	349
	<i>References</i>	352
	<i>Index</i>	367

## ABBREVIATIONS

---

BAT	best available technique
BOD	biological oxygen demand
CFC	chlorofluorocarbon
CHP	combined heat and power
CLO	compost-like output
C:N	carbon-to-nitrogen ratio
CO <sub>2</sub> eq	carbon dioxide equivalents
COD	chemical oxygen demand
EEIO	environmentally extended input-output
EIA	environmental impact assessment
EPR	extended producer responsibility
EU	European Union
GDP	gross domestic product
GHG	greenhouse gas
GHV	gross heating value
HDPE	high-density polyethylene
HHV	higher heating value
LCA	lifecycle assessment
LCI	lifecycle inventory
LCIA	lifecycle impact assessment
LHV	lower heating value
MBT	mechanical biological treatment
MFA	material flow analysis
MRF	material recovery facility
MSW	municipal solid waste
POP	persistent organic pollutant
RCRA	Resource Conservation and Recovery Act
RDF	refuse-derived fuel
three Rs	reduce, reuse, recycle
SDGs	Sustainable Development Goals
SIA	social impact assessment
US EPA	United States Environmental Protection Agency
VOC	volatile organic compound
WFD	Waste Framework Directive

## SI UNITS AND PREFIXES

---

d	day
g	gram
G	giga
ha	hectare
J	joule
k	kilo
L	litre
m	milli
M	mega
m	metre
m <sup>2</sup>	square metre
m <sup>3</sup>	cubic metre
μ	micro
t	tonne
W	watt
Wh	watt hour

## LIST OF BOXES

---

1.1	The context of waste generation and composition	20
1.2	Waste crime	31
1.3	Contamination of steel with copper	35
2.1	Disentangling entanglement	48
2.2	Throwaway living	54
2.3	Informal waste work in Mexico City	56
2.4	If only... an opportunity cost perspective	60
3.1	Examples of MFA studies	67
3.2	An MFA of coprocessing of contaminated waste	71
3.3	The ‘zero-burden’ approach in waste LCA	76
3.4	LCA of the waste hierarchy: Goal and scope	79
3.5	LCA of the waste hierarchy: Allocation issues	81
3.6	LCA of the waste hierarchy: Impact assessment	84
3.7	LCA of the waste hierarchy: Interpretation	86
3.8	Contested evidence: How to dry your hands	88
3.9	An EIA for the Dilla City sanitary landfill	91
3.10	An SEIA for the Adjara Solid Waste Project	93
3.11	Cost-benefit analysis of a landfill mining project	95
3.12	Consumption-based accounting with EEIO	97
4.1	The return of resource value in Japan	106
4.2	Waste in the time of cholera	107
4.3	Not such a lovely canal	109
4.4	<i>Khian Sea</i> and the Basel Convention	120
4.5	ISO 14001: A very successful voluntary programme?	121
4.6	Don’t mess with Texas	123
4.7	What is the right price for landfilling waste?	125
4.8	Competing ‘frames’ in defining policy problems	130
4.9	Developing countries as policy leaders?	132
5.1	Why a food seller may want to waste food	142
5.2	Phasing out lead-based paint	146
5.3	Getting more beer out of malt and hops	147
5.4	The environmental benefits of lean manufacturing	148
5.5	Planned obsolescence	150
5.6	Product substitution: Newer is better?	154
5.7	Service demand reduction: Did we ever need straws?	156
5.8	An EPR scheme for textiles in France	160
6.1	Making waste collection a breeze	170
6.2	An example of BAT	177



6.3	Waste generation by the metal-finishing industry	184
6.4	In the headlines: Waste storage	185
7.1	Is there an optimal level of recycling?	229
7.2	Bio-based and biodegradable plastics	236
7.3	Doubling down on timber	249
7.4	Where does a tired tyre retire?	252
8.1	Who lives next to an incinerator?	267
8.2	Living laboratories for micro-anaerobic digestion	273
8.3	Energy and raw materials from anaerobic degradation	278
8.4	Landfill siting: The birth of environmental justice	286
8.5	Modelling landfill gas generation in Mexico	294
8.6	Getting rich from landfill mining of Bitcoin	297
9.1	The intellectual history of circular economy	309
9.2	The Sustainable Development Goals	313
9.3	Limits and opportunities for upcycling	320
9.4	Rebound effects of buying a used smartphone	323
9.5	Examples of circular product design	326
9.6	Supply chain waste of sandwiches	331

## **LIST OF EXERCISES**

---

1.1	Varieties of the waste hierarchy	27
1.2	Waste audit: Food packaging waste	29
2.1	Matching impact categories and DPSIR	48
2.2	Social impacts of closing Jardim Gramacho landfill	58
3.1	A common stock-and-flow problem	74
3.2	Understanding an LCA study	86
4.1	Major legislation in your country	111
4.2	Choosing policy instruments	132
4.3	Using MFA and LCA for policy evaluation	134
5.1	Addressing causes of waste	141
5.2	Waste prevention policies	159
6.1	Finding the right tool for the job	175
6.2	How to not repeat history	187
6.3	Separating separation processes	194
7.1	Choosing recycling metrics	221
7.2	Recycling smartphones	247
8.1	Calculating heating values	259
8.2	How energy gets lost	264
8.3	Feedstock properties	275
8.4	Finding the perfect match... between waste and soil	302
9.1	Applying the 10 Rs	318
9.2	Making a profit in a circular economy	328
9.3	Symbiosis on campus	336
9.4	Meso and micro circular economy indicators	338
9.5	The transition from recycling to reuse	345

## **FOREWORD**

---

This book starts from the belief that waste management cannot be understood without considering the wider context of production and consumption. Products and services result from complex material lifecycles, starting with the extraction of raw materials, followed by material processing and product manufacturing, before delivering their intended service to consumers. After their use, products are discarded and may be recovered or disposed. This systems perspective on material use is essential to address the social and environmental impacts of waste.

The early chapters of this book describe the wider systemic context of waste management, the impacts of materials and waste throughout the lifecycle and the methods used to evaluate impacts and strategies to mitigate them. The book then turns to policy and regulation, followed by waste management practices and technologies, largely in the order of the waste hierarchy: waste prevention, collection and treatment, recycling and disposal. The final chapter on the circular economy offers both a summary of the book and an outlook for better materials management.

This book is published open-access under a CC-BY licence to avoid barriers to learning and sharing. Educators and learners can distribute, adapt and build on the content of this book as they wish, as long as they attribute the source. Exceptions apply to content that was licensed by others to us, with the relevant permissions stated in the main text or captions. If you find any mistakes or deficiencies in the book, please contact the authors or UCL Press. Your feedback is essential for us to keep developing this learning resource.

## ACKNOWLEDGEMENTS

---

Writing a textbook is harder than the writer imagines beforehand. Fortunately, we received financial and intellectual support to develop this book. We would like to acknowledge the funding from the EPSRC Impact Acceleration Account (IAA) award to UCL (EP/R511638/1) and the in-kind support from the Chartered Institution of Wastes Management (CIWM). The grant supported writing time and knowledge exchange with experts. We are grateful to the attendees of the workshops for sharing insights that helped us shape the book.

A major part of the book was written by Stijn van Ewijk during his time as a postdoctoral associate at the Yale Center for Industrial Ecology. We thank Professor Marian Chertow for providing a supportive writing environment and her unlimited enthusiasm for all things waste. We also appreciate the tolerance and support of our partners, Elze and Greg, throughout the years of writing.

We are grateful to our students at UCL, for whom we designed the module Waste and Resource Efficiency, which prompted the development of this book. The book also draws on the course Industrial Ecology, taught by Stijn van Ewijk and Marian Chertow at Yale University. The enthusiasm of the industrial ecology students made teaching an absolute joy and contributed to various sections of the book. We are also grateful to the students of the Yale course Waste in the Urban Environment, taught by Alessio Miatto, who gave feedback on the first and last chapters of the book.

Finally, we thank UCL Press for their commitment to open-access publishing and the excellent team that supported us. During the years it took to write this book, we worked with four different editors, each of whom provided outstanding support, with seamless handovers between them. We hope this book will further their and our mission to support learning as widely as possible.





# 1

# MATERIALS AND WASTE

## LEARNING OBJECTIVES

After studying this chapter, you should be able to:

- describe the patterns and drivers of global material use
- explain the concept of the anthropogenic material lifecycle
- list the relative quantities and types of waste that are generated
- explain the main elements of a waste management system
- describe fundamental challenges in waste management

## 1.1 INTRODUCTION

---

The things in our lives are converted to waste when they become unwanted and are discarded, abandoned or simply forgotten. Waste is an unintended and often inevitable consequence of the use of products, as well as of the extraction and processing of materials to make these products. According to estimates, the world produces about 20 gigatonnes of processing and end-of-life waste. This equates to an average waste generation rate of 55,000,000,000 kilograms of waste every day, or 7.5 kilograms of waste per person per day.

We generate so much waste that its collection, treatment, recovery and disposal have become an industry in itself. These activities together are called waste management. Waste may sometimes be avoided through waste prevention and the circular use of resources, which is why the title of this book speaks of waste management but also of ‘circular economy’. Together, waste management and circular economy strategies aim to reduce or minimise both resource use and waste generation, as well as their impacts on the environment and human health.

In this book, you will learn about the generation, collection, treatment, recovery and disposal of waste and the efficient and circular use of resources. The current chapter introduces the subject; the subsequent chapters will explain the impacts of waste, waste policy and legislation, and practices and technologies for waste prevention, collection and treatment, recycling, energy recovery and disposal. The book concludes with a chapter on the circular economy, which offers a holistic set of strategies for reducing waste.

The present chapter explains key concepts regarding material use and waste generation and management, and outlines the major themes addressed in this book. It first looks at the materials we use and considers why we use so much of them, then turns to the material lifecycle and discusses patterns of waste generation. Finally, the chapter introduces the main elements and challenges of waste management. Altogether, this chapter provides the basic knowledge that is required to understand all of the succeeding chapters.

## 1.2 DRIVERS OF MATERIAL USE

### 1.2.1 Types of materials

Consider for a moment the materials that are required to support your daily activities. You wake up in a building made of wood, brick, concrete, steel and glass. You open the curtains or blinds, which are made of textiles or plastics. For breakfast, you go to the kitchen, where you find chairs, a table, a kitchen top, cupboards, appliances, cutlery, bowls, plates and mugs. These are made of metals, wood, plastics and ceramics. Your fridge and kitchen cupboards may store cereals, bread, fruits, vegetables, dairy products and meat. You may hardly have woken up, but you have already encountered many different materials.

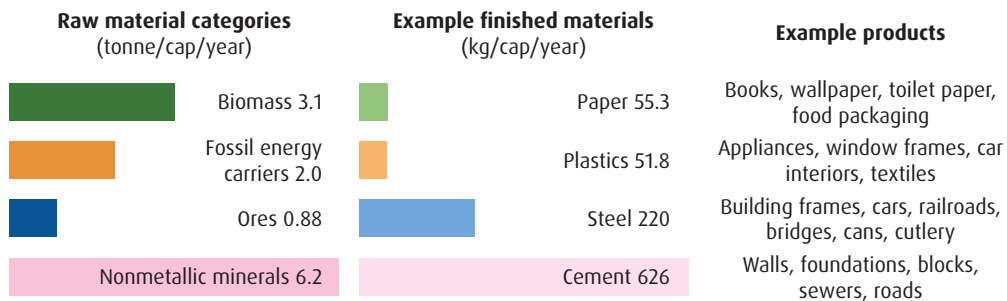

**Figure 1.1 An overview of widely used materials and products in 2015.** Krausmann et al. (2018); FAO (2019); CEMBUREAU (2016); Geyer, Jambeck and Law (2017); Worldsteel Association (2018).

Everything we use is made of some material. In this book we consider only those materials that are directly used or consumed by human beings, excluding all those materials in the natural environment that are not directly used by us. However, we have to consider those parts of the natural environment that are indirectly affected by production and consumption through waste disposal and pollution. For example, the atmosphere, land and water bodies are relevant as sinks for waste that is emitted by our waste management practices.

Figure 1.1 shows some of the most widely used materials, each of which falls into one of four main categories: biomass; fossil energy carriers; metal ores; and nonmetallic minerals. Biomass refers to organic biotic materials, which can be regenerated, assuming good stewardship. Biomass covers foods and materials that are cultivated or taken from natural ecosystems. Cultivated biomass includes wood, meat and fruits that result from plantation forests, livestock farming and agriculture. Foods and materials that are taken from natural ecosystems include

wood, fish, meat and fruits that are gathered from natural ecosystems, such as forests, grasslands, wetlands, rivers and oceans.

Fossil energy carriers include coal, peat, oil and gas; the fossil fuels that are used for the production of plastics are also included. Peat takes more than 100 years to regenerate, while coal, natural gas and oil, although of biological origin, can only be naturally regenerated over millions of years and will eventually run out. Ores include iron ore and ores of nonferrous metals such as copper, aluminium, lithium and cobalt. Nonmetallic minerals include materials such as marble, granite, chalk, slate, limestone, clay, sand, salt and fertilisers. Metals and minerals are not of biological origin and they are not infinitely available.

### 1.2.2 Drivers of material use

Hunter-gatherers, living thousands of years ago, did not wake up in buildings made of concrete and steel. Compared to today, prehistoric societies used virtually no materials, but we need not go so far back in history to conclude that material consumption has grown tremendously; just a century ago, we used far less materials than we do today. [Figure 1.2](#) shows this clearly. Material extraction in 1900 was about 10 times less than in 2000. It is also clear from the illustration that material use has grown exponentially; the most recent years feature the largest increases in extraction.

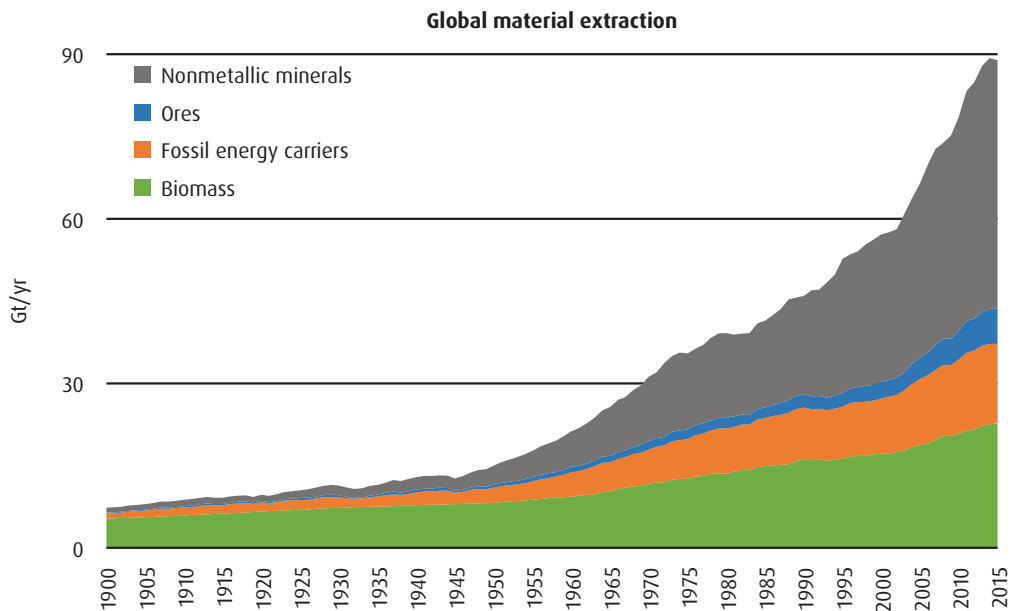

**Figure 1.2 Historical global material extraction.** Data from Krausmann et al. (2018).

Why does material consumption grow so quickly? Consider the following explanations. Which answer do you think is correct?

- Population growth.
- Economic growth.
- Technological change.

In fact, all three answers are correct. Over the past century, the global population grew from 1.6 billion to 6.1 billion, the total economic output grew from 1.9 to 37 trillion USD and we developed a great number of new technologies, such as petrol cars, skyscrapers, passenger planes and mobile phones – technologies that require both greater volume and a greater variety of materials than their predecessors. Simply put, a greater number of people consume more goods, richer people consume more goods, and technology enables us to use more materials to travel faster, to live more comfortably and to eat a greater volume of more diverse foods.

The role of population ( $P$ ), affluence ( $A$ ) and technology ( $T$ ) in generating environmental impacts ( $I$ ) has been formalised in what is called the 'IPAT equation' (Ehrlich and Holdren 1971), shown in Equation 1.1.

$$I = P \times A \times T \quad \text{Equation 1.1}$$

In the IPAT equation,  $I$  could be a variety of impacts, such as material consumption, waste generation or air emissions. For now, we are interested in material consumption, measured in tonnes. For a given group of people, say, the inhabitants of a country, the three variables are defined as in Equation 1.2. The variable  $P$  is defined as the total population, while  $A$  is measured as the annual gross domestic product (GDP) – a monetary estimate of the value of everything produced – divided by the population. The variable  $T$  is defined as the amount of material per unit of economic output, measured in tonnes per unit of GDP

$$\text{Material consumption} = \text{Population} \times \frac{\$}{\text{population}} \times \frac{\text{tonnes}}{\$} \quad \text{Equation 1.2}$$

This equation is very useful; each variable reveals the contribution of the relevant driver to total material consumption. These contributions are helpful to know for the purpose of projecting future material consumption or lowering its impacts. The equation helps us understand some of the most noticeable patterns in material consumption.

- Countries with large populations use more materials.
- High-income countries with large economies use more materials.
- Countries with large primary industries use more materials.

The latter is explained by the technology factor, which asserts that countries that depend on mining and manufacturing for economic growth consume very high tonnages of materials per dollar, whereas countries with a large financial sector use very few materials per dollar of economic output. The technology factor is also called the material intensity of the economy because it describes how intensively an economy uses materials to generate economic output.

### 1.2.3 Why consumption grows

It is intuitive that population growth, economic growth and technological change drive material consumption. It is harder to explain why human beings go through the effort of continuous and increasing production and consumption. Would it not be easier to be happy with what we already have? This question borders on the philosophical, but there is a straightforward way to understand our material desires by looking at universal human needs and the materials and products that are required to satisfy them.

One way to identify your human needs is to consider what your immediate requirements would be if you were dropped alone in a deserted mountain range. What would you need most urgently?

- Clothing to protect you from the weather and cold.
- Food and drink to protect you from hunger and thirst.

Fed and clothed, your life would still be less than great. You would face threats from wild animals, weather events and sickness. You would need other people to help you deal with this; together you could arrange shelter and medical care. Coordinating these activities would require a complex social system with internal demands for communication, transport and safety. By participating in this social system and actively contributing to it through voluntary or paid work, you would meet the need for friendship and a meaningful existence.

Clearly, there are many human needs, and the fulfilment of one need can require a host of activities and material items. We can reduce the complexity by identifying three main categories of human needs (Gough 2017).

- *Health* covers our need for physical and psychological health, the fulfilment of which requires, among others, nutrition, warmth and medical care.
- *Participation* covers our needs for belonging, friendship and a meaningful social life, which requires an organised and safe social environment.
- *Autonomy*, the opposite of powerlessness, relates to our ability to make informed choices about what to do in life and how to achieve it.

These needs are universal; they are shared across cultures and time. However, they can be satisfied in various ways, using various technologies, and herein lies the key for understanding consumption and its growth. First, newer technologies are often better at helping us meet our needs. For example, modern healthcare has greatly reduced child mortality, but it involves a vast range of material applications, for example, hospital buildings, MRI scanners and ambulances.

Second, new technologies require a host of additional technologies and must operate within a wider infrastructure. For example, the introduction of electricity not only required power plants, but also coal mines, rail and road transport, an electricity grid and electric bulbs and appliances. The production of all these new technologies required more metal-ore mines, metallurgical plants, manufacturing facilities and yet more rail and road transport.

Third, some needs are insatiable; the richer we are, the more we will buy to fulfil these needs. In high-income communities, social participation can require multiple cars, laptops and phones per household, which was unthinkable only 100 years ago in these communities and is still unthinkable in low-income communities. Smartphones do not meet an urgent need; however, once they were introduced, it became nearly impossible to maintain a normal social life without one. This effect is reinforced by our tendency to buy what others have to increase our social standing.

Some needs, however, are satiable, including many health-related needs. [Figure 1.2](#) shows that the extraction of biomass has grown much more slowly than that of all other materials. This is partly because the need for food is satiable; it is possible to eat somewhat more if you wish to – maybe even tripling the recommended calorie intake – but even for athletes this could be too much. (To continue to sell more, the food industry markets low-calorie products we can eat greater amounts of.)

There are many more reasons why consumption tends to grow. Most importantly, the dominant political and economic model emphasises economic growth, endorses great consumer and producer freedom and supports relentless advertising and the use of credit for purchases. Without further discussing the workings of free-market economies, we can conclude with a quote by the influential economist Tim Jackson: ‘[P]eople are persuaded to spend money we don’t have, on things we don’t need, to create impressions that won’t last, on people we don’t care about’ (Jackson 2009).



## 1.3 THE MATERIAL LIFECYCLE

### 1.3.1 The anthropogenic material system

From the perspective of materials, human beings are bad travel companions. Consider a steel spoon; on the long journey from the iron ore mine in Chile to the steel plant in the United States, to the manufacturer in Germany, to the consumer in France and to the recycler in China, it hardly gets a chance to establish a meaningful relationship with us. If the spoon is lucky, it may retrace its steps upon being remelted and travel back to the same manufacturer and consumer. But even when that happens, the spoon may have become a fork instead. It could also have become a steel girder in New York or a railroad track in Argentina.

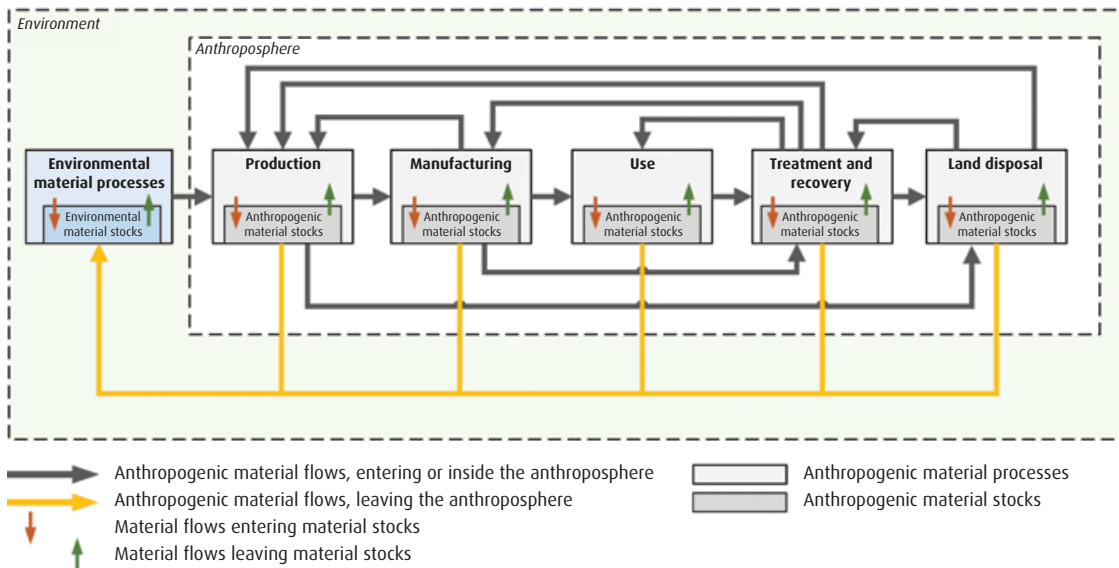

**Figure 1.3** The anthropogenic material lifecycle. UNECE (2018).

The journey of materials is called the material lifecycle as shown in [Figure 1.3](#). Materials are initially extracted from the natural environment through mining, excavation, harvesting, hunting or fishing. They enter the *anthroposphere*, which describes that part of the environment made or modified by humans. The boundary

between the environment and the anthroposphere is somewhat imprecise because very few parts of the planet are completely unaltered by human beings. We stick with the simple convention that materials are initially taken from the natural environment even if this environment is highly engineered, as is the case, for example, in intensive agriculture.

The natural environment is not static. [Figure 1.3](#) indicates ‘environmental material processes’, which are the natural physical, chemical and biological processes by which wastes are decomposed and natural resources are formed, such as the weathering of rock into soils and sediments, the dispersion of elements and the concentration in deposits, and the biological synthesis and decomposition that underpin the biological lifecycle. The timescales of these processes range from seconds to millions of years. The resources become depleted when they are extracted faster than they are generated; [Chapter 2](#) returns to this idea when discussing sustainability.

Extraction is the start of a journey through a very complex system. Extracted resources are subsequently used for materials production and these materials are used for the manufacturing of products. These products are used and discarded, upon which they are collected, treated and recovered or disposed of. The anthropogenic system covers innumerable technologies, infrastructures, organisations, networks and institutions; there are laws and regulations regarding every sector and every product, and for each sector and each product there may be thousands of producers and manufacturers. There are as many users of products as there are people on the planet.

Material may be lost from the anthroposphere to the natural environment through littering, abrasion, biodegradation, corrosion, decomposition, combustion and evaporation. Material may be fed back to earlier stages in the lifecycle through reuse, recycling and recovery. The uncontrolled disposal or loss of material, including as emissions to air, water and soil, constitutes a return to the environment. However, the storage of waste, including the controlled disposal of waste into landfills, is considered an anthropogenic stock of materials because the waste is still in a concentrated form and is thus readily accessible to us.

### 1.3.2 Lifecycle stages, stocks and flows

It is important to remember the stages of the lifecycle because we will return to them throughout the book, as well as other components of [Figure 1.3](#). Though other books may use slightly different terminology, in this book the lifecycle stages are defined as follows:

1. *Production* covers the primary industries that provide primary feedstocks: agriculture, forestry, fishing, and mining and quarrying. At this stage, the feedstocks that are produced still need to be turned into useful materials;
2. *Manufacturing* entails the processing of primary or secondary feedstocks into finished materials and products. It covers the processing of feedstocks (e.g., iron ore or steel scrap) into materials (e.g., steel) and then products (e.g., cars);
3. *Use* is the lifecycle stage at which materials and products are either consumed and burnt, such as food and fuels, or used in durable applications, such as cars and buildings. During this stage, durable products remain largely unaltered;
4. *Treatment and recovery* happen upon the discarding of the product by the consumer or business owner of a product. This stage includes activities to separate components of the waste, reduce its volume or potential to cause harm and recover its material or energy value;
5. *Land disposal* is the final stage for materials and products that are not cycled back to earlier stages of the lifecycle. However, materials may still be removed from landfill and cycled back to production through what is called 'landfill mining'.

Stocks are materials that have accumulated in one of the lifecycle stages (see the arrows inside the lifecycle stage boxes in [Figure 1.3](#)). For example, a stock of trees exists in the natural environment. The stock is reduced in size through felling but increases in size through natural growth. In a sawmill, a stock of lumber may be waiting to be cut. In a paper mill, a stock of timber or pulp may be waiting to be processed further. Consumers and businesses own large stocks of wood and paper in the form of libraries, archives, furniture and buildings. A wooden beam in a house is part of the in-use material stock of timber; it is taken out of stock when the house is demolished. Finally, there may be stocks of discarded wood and paper waiting to be treated and recovered. [Figure 1.4](#) shows the global in-use stocks of materials since 1900.

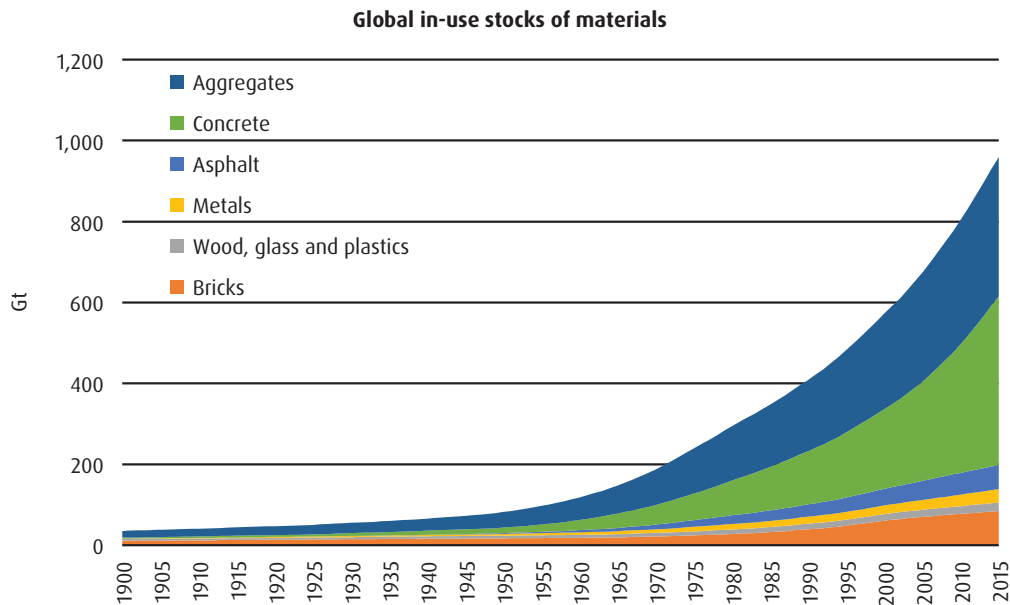
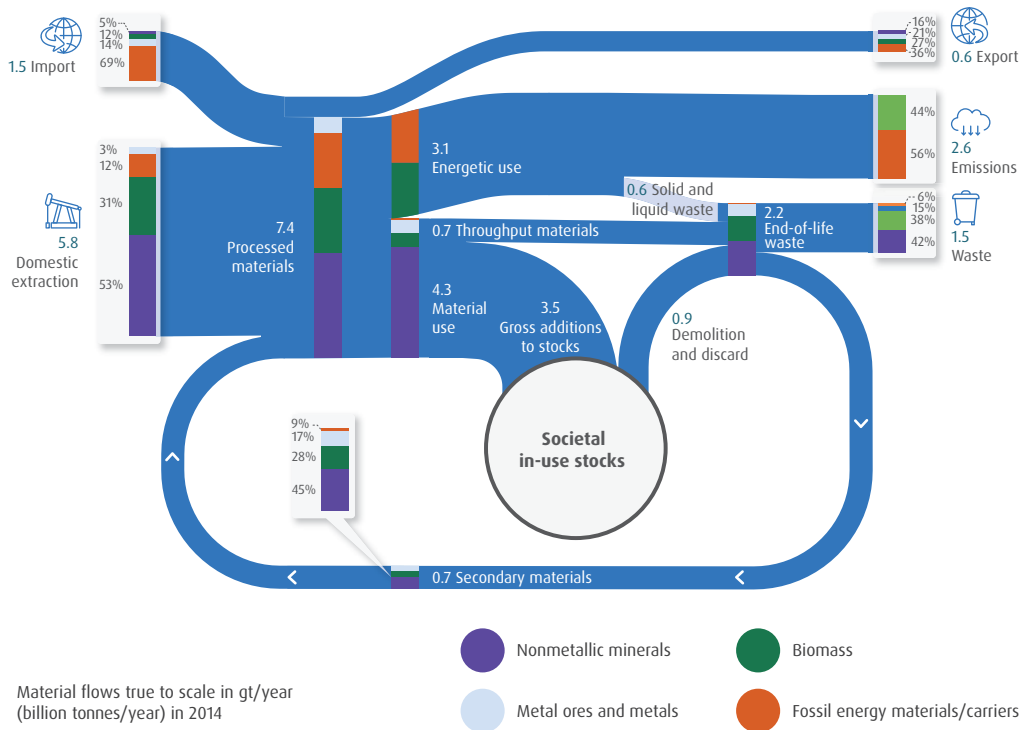

**Figure 1.4 Global stocks of materials.** Data taken from Krausmann et al. (2018).

Figure 1.3 describes both linear and circular modes of production and consumption. The horizontal arrows describe the linear processing of materials from production, to manufacturing, to use, treatment and recovery, and land disposal. The looped arrows describe circularity – the return of materials to earlier stages of the lifecycle with the purpose of avoiding land disposal and reducing the need for primary materials or new products. Waste is generated in production and manufacturing and after use, and goes to treatment and recovery or directly to disposal. Some waste, from any stage of the lifecycle, is returned directly to the natural environment, either through decomposition of biotic materials or through dumping and littering.

### 1.3.3 The economy-wide material lifecycle

Material flows in the anthropogenic lifecycle have been quantified for cities, countries and the globe. Figure 1.5 shows material flows for the economy of the European Union (EU); the width of the flows reflects the quantities, while the arrows indicate the direction. The illustration shows the material lifecycle, including recycling, backfilling (refilling excavations; see Section 8.6.2) and additions and removal from stocks in the use-phase. Similar to Figure 1.3, materials are extracted from the natural environment (‘domestic extraction’), produced and manufactured (‘energetic use’ and ‘material use’), added to stock (‘societal stocks’) or sent for treatment and recovery (‘waste treatment’). The import and export of materials and waste are also included.



**Figure 1.5 The use of materials in the EU in 2019.** Taken from Van Ewijk et al. (2023); redrawn from Mayer et al. (2014).

The colour-coding shows the fractions of the material categories previously introduced in Section 1.2.1. Only two material categories are given for ‘energetic use’: fossil energy materials/carriers and biomass. The other material categories cannot be burnt or eaten. The material use of fossil energy materials/carriers refers mainly to plastic products; the material use of biomass refers to, by and large, paper and timber. A comparison of import and export suggest that the EU is a net importer of, mostly, fossil energy materials/carriers.

Figure 1.5 also shows the materials that leave the system. This includes, first of all, air emissions from the energetic use of materials. When materials are burnt (fuels) or digested (food), they are largely converted into CO<sub>2</sub> and water, which escape into the air. The unburnable residue from combustion – ash – is categorised together with the solid waste from the ‘material use’ of materials. The diagram shows how much of the four categories of materials end up as waste, which together amounts to 2.2 Gt in the EU annually.

Within the category of ‘material use’, Figure 1.5 distinguishes ‘throughput materials’ in non-durable products, such as newspapers and packaging, as well

as dissipated materials such as gritting salt and fertiliser, and ‘additions to stock’ of materials in durable products, such as appliances and buildings. There is no universal distinction between durable and non-durable products, but single-use disposable items generally fall into the latter category. In its waste statistics, the United States Environmental Protection Agency (US EPA) defines durable products as those with a lifetime of at least three years.

## 1.4 WASTE GENERATION

### 1.4.1 Types and quantities of waste

Waste is the unwanted material that we discard. People regularly discard food packaging, food scraps, office paper, plastic carrier bags, newspapers and leaflets. Every once in a while, most people also discard appliances, furniture and clothing. However, as [Figure 1.3](#) showed, the waste we discard as consumers is not the only waste in the economy; waste is also generated by industry and the construction sector. Besides, there is the residual waste from waste treatment and recovery. To describe the sources of waste, we refer to activities that fall within specific economic sectors.

- *Mining and quarrying.* This sector is responsible for extracting fossil fuels (coal, petroleum, gas), metal ores (e.g., iron ore, bauxite) and nonmetallic minerals (e.g., stone, salt). This sector generates mostly mineral waste.
- *Agriculture, forestry and fishing.* This sector cultivates crops (e.g., potatoes, apples) and raises animals (e.g., cattle, poultry). It is also responsible for forestry and logging (e.g., timber production), hunting (e.g., game) and fishing (i.e., wild catch) and aquaculture (i.e., the farming of fish and aquatic plants). This sector generates mostly biotic waste.
- *Industry.* This sector takes raw materials from the above two sectors to manufacture food, textiles, paper, chemicals, plastics, computers, cars and so on. Utilities, which supply mainly electricity and gas, are also counted as industry. Industrial waste is largely abiotic and highly specific to the individual process.
- *Construction.* This sector is responsible for buildings, including housing, and infrastructure such as roads, bridges, tunnels and waterways. The waste from this sector is often called construction and demolition (C&D) waste. This sector produces vast quantities of mostly mineral waste.
- *Households and services.* Household consumption and the service sector (e.g., retail, hospitality) are often considered together because they produce similar waste that is collected together as municipal solid waste (MSW).

- *Waste management.* This sector covers waste collection, treatment and disposal. Waste from water collection, treatment and supply is also included. The waste management sector may seem a taker rather than a generator of waste, but it also generates new wastes (e.g., residues from waste incineration).

Figure 1.6 shows waste generation by sector and type in the EU, illustrating how much each sector (on the left) contributes to the types of waste (on the right). It is immediately apparent that all sectors produce a large variety of waste. It is also apparent that mining and quarrying and construction produce the largest amounts of waste, almost all of which is mineral waste or soil. This does not necessarily mean that the waste from these sectors also has the largest environmental impacts, because the impacts depend strongly on the kind of waste (see Chapter 2).

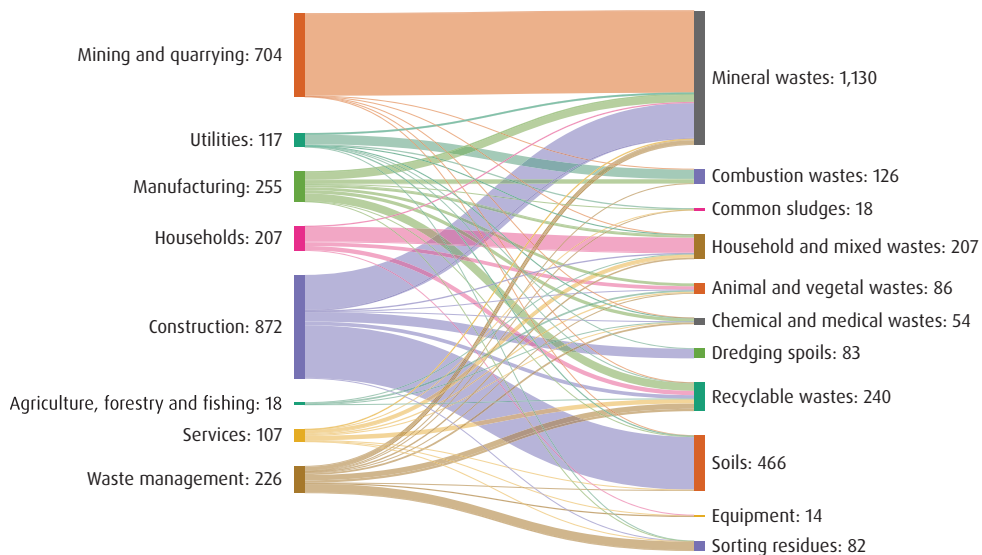

**Figure 1.6 Waste generation in megatonnes in the EU in 2014 by sector and type.** Data taken from Eurostat (2019a). Visualised at Sankeymatic.com.

In Figure 1.6, some waste is double-counted because the collection and treatment of waste generates new forms of waste. For example, ‘waste management’ is shown as a sector which generates waste, but its waste largely results from the collection and sorting of waste from other sectors. Materials that are covered in

'waste management' are shown as a flow from 'waste management' to 'recyclable wastes', and the incineration of waste leaves ash or 'mineral wastes'. Moreover, some of the 'sorting residues' from various sectors are from processing recyclables, including in 'manufacturing'.

Waste can be categorised based on, among others, product type, origin, properties, hazardousness or potential recovery operation. You can recognise these criteria in the waste categories listed in [Figure 1.6](#), which are described in more detail below.

- *Equipment* is a waste stream with the same name as the product. It includes, among others, appliances and end-of-life vehicles.
- *Animal waste* is categorised by its origin; it used to be part of an animal. It includes waste from agriculture and the food processing industry.
- *Recyclable waste* is categorised based on the expected recovery operation and includes metal, rubber, plastics, paper, timber, glass and textiles.
- *Mineral waste* is categorised based on the same properties that define the non-waste minerals, including marble, concrete and sand.
- *Common sludges* are defined by their water content and origin, which are mainly wastewater treatment plants and the food industry.

Some overlap between the categories is inevitable. For example, some materials that fall under 'recyclable waste', such as plastics, are also found in the products categorised as 'equipment'. The category 'mixed ordinary wastes' contains various recyclable waste fractions that are not separately collected for this purpose. Waste that is not separately collected for a specific recovery operation (e.g., sorting for recycling) or that is left after a recovery operation may also be called 'residual waste'.

Municipal wastewater is not within the scope of this book – there are many other books dedicated to municipal wastewater treatment. However, throughout the book, we will refer to the treatment and disposal of the sludge ('sewage sludge') that results from municipal wastewater treatment (and which is included in the aforementioned 'common sludges' shown in [Figure 1.6](#)), as well as the treatment of industrial wastewaters and sludges.

An important categorisation of waste is by its potential impact, typically between hazardous and nonhazardous waste. Hazardous waste poses a major threat to the environment and human health. For example, it may be explosive or toxic. Some types of waste are considered hazardous by definition; other types of waste may need to be tested to find out whether they have hazardous properties. The various hazardous properties of waste are discussed in [Section 2.3.3](#).

Finally, waste is sometimes divided into avoidable and unavoidable waste, to gain a better understanding of the potential for waste prevention. Unavoidable waste includes, for example, banana peels; an example of avoidable waste is



leftovers from dinner. However, the distinction is not set in stone; whether waste is avoidable depends on circumstances including human behaviour, cultural expectations and technological options for waste prevention. Surprisingly, banana peels need not be wasted but can be used in cooking – have a look online for ‘whole banana bread’ or ‘banana peel curry’!

### 1.4.2 Estimating waste generation

How do we know how much waste is generated? Most countries have regulations that require the tracking of waste for the purpose of environmental protection and waste management planning. Different waste types are assigned codes based on their origin or composition, or both (see [Section 4.3.3](#)). The codes are used to track the progress of waste through the waste management system, from generation to treatment and finally to recovery or disposal. To estimate total waste quantities, governments may aggregate the quantities of waste reported to them in ‘consignment notes’ or ‘waste transfer notes’.

Since such reporting systems have limitations, waste quantities are sometimes also estimated using paper or field surveys. For example, to estimate household waste amounts and composition, waste volumes are typically taken from a representative sample of households or waste management facilities. These samples may be further split and subsequently sorted and classified by material and grade. The data is then analysed to arrive at total waste volume and average composition estimates. Analogous sampling programmes may be conducted for industrial sectors. Using statistical techniques, the confidence intervals can be calculated for each waste fraction.

Waste data may also be reported voluntarily by businesses, for example, in the context of sustainability reporting. Moreover, industry associations often gather data from their members to provide an overview of waste generation across their sector.

Often, we do not know exactly how much waste is generated, but only how much is generated in a particular location, by a particular industry or at a particular time. These limited data points can then be used to estimate overall waste volumes, including for locations where a detailed waste survey is not feasible. Essentially, the estimation of waste generation at large scales requires two types of data:

- basic waste data regarding quantity and composition, for example, the quantity and composition of household waste from a middle-income household in Delhi in 2010;
- contextual data regarding source, time and location, for example, the number of middle-income households in Delhi, the wider region, another city or the whole of India.

With detailed knowledge of the waste quantities and composition for middle-income households in Delhi in 2010, it is possible to approximate waste generation in Bangalore, provided we know how many middle-income households there are in Bangalore. If we wanted to estimate waste generation in Delhi and Bangalore in 2020 (a decade later), we could use income data for 2020 and the IPAT equation, assuming waste generation grows proportionally with income (i.e., the technology factor is assumed constant).

The quantity of waste per household is called waste intensity. Another example of waste intensity data is shown in [Table 1.1](#), which depicts waste generation per unit of building floor area – a useful intensity to estimate quantities of demolition waste. The waste intensities are specified by the type of structure, the type of use, the approximate age of the building and the material. The data was collected to help estimate future waste arising from demolition projects, which can support the planning of demolition activities and waste collection and treatment. Other examples of waste intensities include waste generation per person, per unit of economic output and per product sold.

**Table 1.1 Demolition waste intensities per unit of floor area for various building types and time periods in China (kg/m<sup>2</sup>).** Ding and Xiao (2014).

Structure type	Usage	Ages	Steel	Wood	Concrete	Brick or block	Gypsum
Brick-wood	Residential	Before 1980	2	35	–	771	44
Brick-concrete	Residential	Before 1980	9	28	439	676	48
		1980–1999	18	26	716	672	32
		After 2000	54	28	791	683	30
	Non-residential	Before 1980	12	18	529	603	25
		1980–1999	28	24	876	632	21
Concrete	Residential	1980–1989	38	23	925	317	19
		1990–1999	39	22	1,012	329	24
		After 2000	79	21	1,116	343	18
	Non-residential	Before 1980	32	21	592	404	17
		1980–1989	37	25	988	402	14
		1990–1999	41	22	1,186	395	18
		After 2000	110	22	1,252	382	16
Steel	Non-residential	After 1990	197	32	1,246	132	–

The analyst should carefully check how waste quantity and composition data was collected or estimated, as this can explain likely biases or discrepancies in the data, aiding the interpretation of the usefulness of the data. Aspects to watch out for include the following;

- Some waste contains water, which may be reported on a wet basis (moist, as a percentage of total mass), on a dry basis (moist, as a percentage of dry mass) or not at all.
- Mixed waste streams are difficult to categorise and reported data may therefore include a large category of ‘other’ waste of unknown composition.
- The ‘total’ waste generation reported may be incomplete, for example, if some facilities are exempt from reporting, or if data from an industry association only includes members of the association.
- The reported figures may be estimates rather than measurements, and may be based on questionable assumptions. For example, waste generation data may have been calculated based on non-representative waste intensity factors.
- Waste is generally seen as a negative impact and generators may be tempted to report smaller amounts of waste than are actually generated.
- Waste that is recovered may be perceived as not being waste at all, and hence excluded from the estimates. For example, industry reports may only count waste to landfill as ‘waste’ and claim ‘zero waste’ when all waste is recycled or incinerated.

Finally, waste generation may be inferred from material consumption and stock building patterns. For example, if we know how many cars have been sold and how many cars are still in use, we can calculate how many cars must have been scrapped. This method is part of ‘material flow analysis’ (MFA), which is further explained in [Section 3.2](#). [Figure 1.7](#) shows the result of this type of analysis. It presents an estimate of the generation of processing waste from production and manufacturing, and end-of-life waste from used products and infrastructure, based on a systematic assessment of material inputs (as shown in [Figure 1.2](#)) and material stocks (as shown in [Figure 1.4](#)).

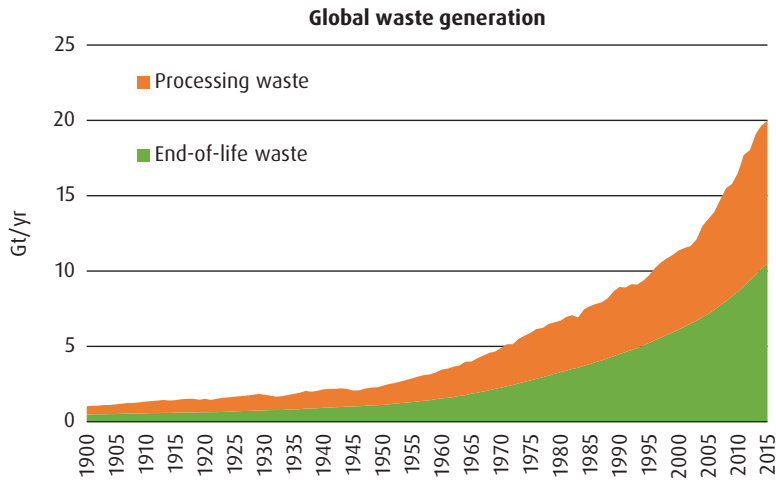

**Figure 1.7 Global generation of processing waste from production and manufacturing, and end-of-life waste from used products and infrastructure.** Data taken from Krausmann et al. (2018).

### BOX 1.1 THE CONTEXT OF WASTE GENERATION AND COMPOSITION

Both waste generation and waste composition depend on contextual factors, including the income levels of waste generators. Figure 1.8 provides key figures regarding municipal solid waste (MSW) composition around the world. It shows that people in high-income countries produce more MSW per person per day, which should have been expected based on the IPAT equation (Section 1.2.2) – higher affluence tends to lead to higher impacts, including waste generation.

The charts also show that MSW in low-income countries has a higher fraction of organic waste. A low income is typically spent only on the most important products, which always include food and drink; the organic fraction in the waste is therefore relatively high. For people with higher incomes, food is just one of many items frequently bought. Besides, low-income households often process basic ingredients at home instead of buying processed foods, generating more organic waste like stalks and peels.





## 1.5 WASTE MANAGEMENT

### 1.5.1 Waste management system

Once a material or product has been discarded, it goes through several management stages. For example, a recycling bin at a university campus is emptied into a truck and the waste is brought to a material recovery facility (MRF, pronounced 'merf'). Here, the waste is treated for recovery by separation into recyclable fractions of paper, glass, plastic and metals. The recyclables are transported to reprocessing facilities, such as paper mills. The sorting process generates several residues, including dust and nonrecyclable materials, and these are incinerated or landfilled. The ash from incineration may also be landfilled.

Waste management is the sum of collection, transport, treatment, recovery and disposal of waste. A large part of this book will focus on its purpose, function and impacts.

- *Collection* includes household and commercial collection, industrial collection, street sweeping and collection from public bins.
- *Transport* consists of the haulage of waste between collection, treatment and disposal facilities. Waste may be temporarily stored at various sites.
- *Treatment* includes physical, physicochemical, biological and thermal treatments to separate, sterilise and stabilise waste and to reduce its volume.
- *Recovery* consists of converting waste into useful material or energy products after it has received the appropriate treatment.
- *Disposal* mainly consists of the indefinite storage of waste in engineered landfills to control potential risks to human health and the environment.

Figure 1.9 gives examples of waste management. It shows advanced options, such as the source-separation of recyclables and the incineration of waste to produce electricity and district heat, as well as more rudimentary practices, such as the landfilling of waste. Informal waste-picking happens everywhere to some extent, from people scavenging on dumps in developing countries, as shown in one of the images in Figure 1.9, to people in the richest cities retrieving bottles from trash cans to obtain the deposit at a bottle-return station.



Source-separation of waste at Table Mountain, Cape Town, South Africa (Rachel Lovinger).



Garbage truck with automated side loader for residential waste collection, United States (ACE Solid Waste).



Material recovery facility for sorting mixed recyclables, London, United Kingdom (Urban Greendom).



Bulldozer distributing waste at the Gila County landfill, Arizona, United States (Alan Levine).



Waste incineration facility producing electricity and district heat, Uppsala, Sweden (Vattenfall).



A waste picker scavenging for valuable materials on a waste dump, Jakarta, Indonesia (Jonathan McIntosh).

**Figure 1.9 Examples of the collection, transport, treatment, recovery and disposal of waste.**



## 1.5.2 Waste management options

Over time, a variety of undesirable practices have been used to get rid of waste, such as littering, dumping in water bodies and uncontrolled burning. However, today, most waste management is guided by the waste (management) hierarchy, which states that waste prevention is most desirable, followed by reuse, recycling and energy recovery. Disposal of waste is considered the least desirable. Often, the waste hierarchy is summarised as the ‘three Rs’: reduce, reuse, recycle. Waste prevention features in the waste hierarchy but it is fundamentally different from waste management. Waste prevention needs to happen before materials become waste and is therefore not under the control of waste managers.

The decision between waste management options is driven by social, technical, economic and environmental concerns. Based on these concerns, it is not always feasible or desirable to achieve the highest priorities in the waste hierarchy, which leaves waste managers with the difficult question of how to manage the trade-off. Figure 1.10 shows waste hierarchies at the city, regional, national and supranational level. The Japanese hierarchy is summarised as the image of the three Rs, explained by the Japanese government as follows: ‘The three figures are taking one step forward, evoking a sense of progress. Orange represents people, green the Earth, and blue the sky.’

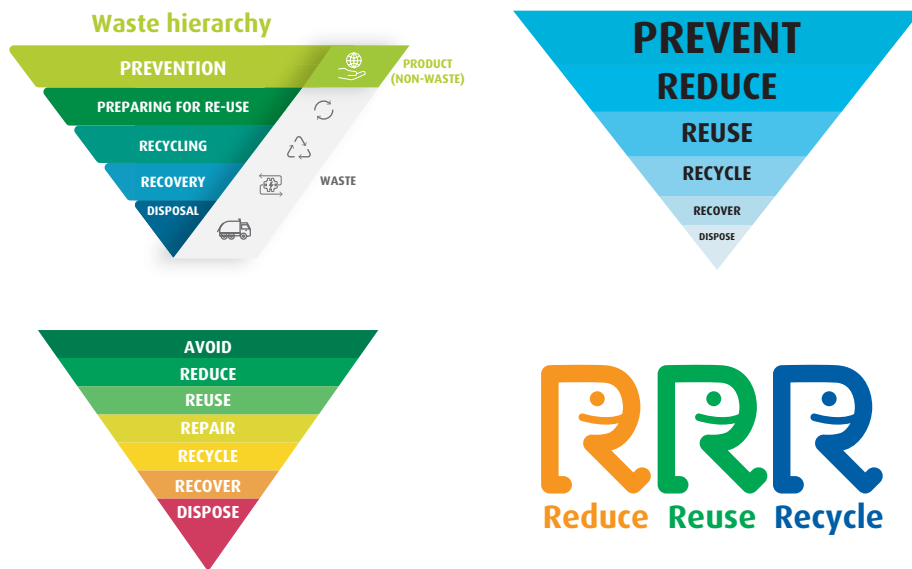

**Figure 1.10 Representation of the waste hierarchy for various jurisdictions. Clockwise from top left: the European Commission, the City of Kirkland in Washington State, United States, the Japanese government, and the Northern Adelaide Waste Management Authority, Australia. EC (2023), City of Kirkland (2023), METI (2023), NAWMA (2023).**



The options in the hierarchy often include the following:

- *Waste prevention* entails the reduction of waste generation and the reduction of the hazardous qualities of waste. It can be achieved through changes in the production and use of products, for example, through innovative manufacturing processes and the design of durable products that can be reused multiple times.
- *Recycling* is the use of waste for a useful purpose that would otherwise be fulfilled by virgin materials. With closed-loop recycling, the waste is used in the original production process. For example, old magazines may be used to produce new magazines. If the wastepaper is used for insulation, it may be called open-loop recycling, because it cannot be turned back into paper at the end of its life.
- *Recovery* most often refers to capturing the energy in the waste through thermal treatment or the conversion of waste into fuels. Potential thermal treatments include energy recovery from the combustion of nonrecyclable waste in large incineration plants, and the anaerobic digestion (AD) of green waste. Other recovery processes include backfilling to fill excavated areas or create landscape features, and the spreading of waste on agricultural land to improve its fertility, provided that these practices cause no harm and serve a useful purpose that would otherwise be filled by virgin materials.
- *Landfill* refers to the indefinite storage of waste in especially prepared sites on land. Modern landfills are designed to control the emission of pollutants to the environment and to minimise risks to human health and the environment. They are different from dumps, which are an uncontrolled form of disposal.

Figure 1.11 shows the MSW treatment fractions in various global cities. The stacked bars are sorted in accordance with the waste hierarchy and the cities are sorted based on their performance, with the city with the highest recycling rate at the top. The category 'other' includes disposal in both modern landfills and dumps. A clear pattern emerges: high-income countries known for strict environmental policies tend to have the highest recycling rates.

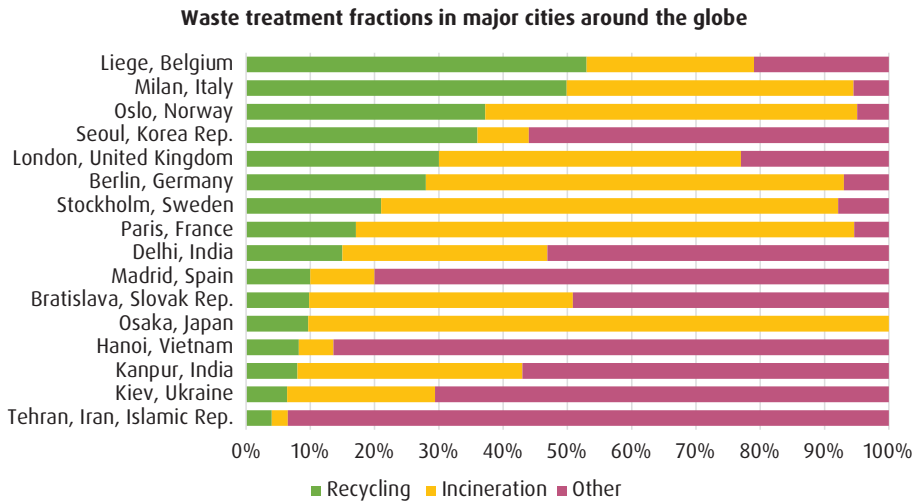

**Figure 1.11 MSW treatment in various cities.** Data taken from Kaza et al. (2018).

Figure 1.12 shows the treatment of all waste, not just MSW, in the European Union. Landfill and other disposal make up the largest fraction of waste treatment, with recycling second. A large proportion of waste that is landfilled is mineral waste, combustion waste (ash) and soils. Incineration is categorised into incineration with and without energy recovery; the latter happens when the waste does not have sufficient heating value or the facility does not have the technology to recover the heat. Backfilling is almost exclusive to mineral waste and soils.

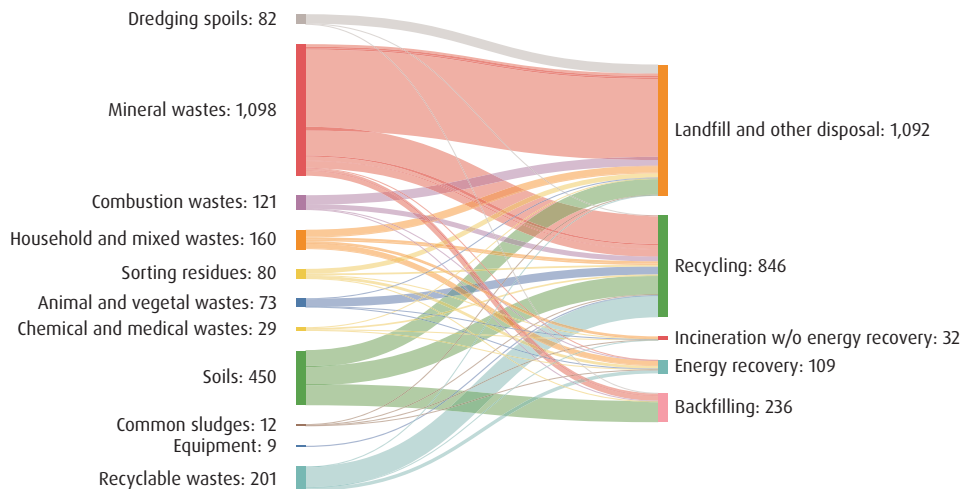

**Figure 1.12 Waste treatment in the EU in 2014 by type of waste and treatment.** Eurostat (2019b). Visualised at Sankeymatic.com.

The quantities of waste treated according to [Figure 1.12](#) do not exactly match the quantities of waste generated in [Figure 1.6](#). This is because, among other reasons, waste generation and treatment are reported separately, waste is treated various times and is thus double-counted (see also the discussion of [Figure 1.6](#)) and some waste is converted to water vapour and CO<sub>2</sub> emissions during treatments such as drying and incineration. Finally, waste is traded with countries outside of the EU.

Besides the waste hierarchy, two further important concepts in waste management are efficiency and circularity. These terms may refer to processes or practices, such as efficient waste separation or the circular use of plastics, or more broadly to material use in the economy, commonly in the context of the terms ‘resource efficiency’ or the ‘circular economy’. The latter two concepts are not always well defined but are generally understood to capture the following.

- *Efficiency*, or resource efficiency, emphasises getting useful outputs – products, services, income – from material inputs.
- *Circularity*, or a circular economy, emphasises keeping materials in use through circulation at their highest value, which includes reuse, recycling and recovery.

Efficiency and circularity are two sides of the same coin; more circular material use leads to higher overall efficiency, whereas efficient processing allows more circulation. For example, steel recycling (the circular use of steel) allows us to make more use of the iron ore that was initially mined to produce the steel (the efficient use of iron ore). At the same time, efficient separation of steel scrap from other waste allows us to circulate more steel. [Chapter 9](#) returns to these subjects in discussing the prospects for a circular economy.

### EXERCISE 1.1 VARIETIES OF THE WASTE HIERARCHY

The waste hierarchy is the backbone of waste management in many countries, cities and organisations. Look up the waste management policies, plans or programmes for your country, city or university. Does the document mention the waste hierarchy? If not, does it recommend actions that are largely consistent with the waste hierarchy? Do any of the plans depart from the hierarchy? How and why?

### 1.5.3 Waste auditing

A waste audit is an essential preliminary step in developing a strategy for waste management – and waste prevention, if possible. Waste auditing is a method for establishing the quantity and composition of waste. It is often conducted at the scale of an organisation, business or city. The waste audit aims to understand the processes that cause waste to arise, as well as to track the quantities and compositions of the arisings. Based on this information, organisations can take measures to reduce waste generation and improve management in accordance with the waste hierarchy.

Universities are among the organisations that conduct waste audits. Such an audit starts with a planning stage, which identifies when and where to look for waste and what types of waste to distinguish. The implementation stage consists of the collection, sorting and analysis of the contents of waste bins and containers. Since waste can be dangerous, an audit requires certain safety precautions, such as the wearing of protective clothing, safety goggles and gloves when handling waste. A good waste audit (whether at a university or elsewhere) considers the following factors:

- *Types of waste.* Depending on the purpose of the assessment, the team may look specifically for wastes that are reusable and recyclable. For university offices, the audit may distinguish between various types of paper, since these could potentially be collected separately for high-quality recycling. For the university canteen, the audit may focus on disposable items such as plastic cutlery, since such waste could have been prevented.
- *Waste sources.* Waste generation varies strongly by source, especially on a university campus. For example, the bin next to the printer will typically contain only paper waste, whereas the bins in the canteen will contain mostly food and packaging waste. In the labs, totally different kinds of waste are discarded. To measure campus-wide waste generation, the waste audit team needs to sample from various locations.
- *Processes.* The processes by which materials become waste reveal opportunities for prevention, treatment and recovery. The audit may identify a lack of seating in the university canteen as a causal driver for take-away purchases, which subsequently leads to more packaging waste. In the labs, the choice of equipment and procedures may lead to excessive use of chemicals or spillages, implying both inefficient use of materials and physical waste.
- *Inventories.* Waste often results from inventories that are deteriorated, spoilt or no longer useful. A waste audit can show how better inventory

management can lead to more efficient use of materials and less waste. For example, waste can be reduced by placing orders more frequently and adjusting each order to the best possible estimate of demand. Inventory management applies to almost anything, from office supplies to lab chemicals.

- *Time.* Waste generation depends on the time of day, the day of the week and the season. It also depends on the patterns of an organisation; waste generation on a university campus may be less on the weekends and during holidays. To understand what types of waste are generated throughout the year, the audit may require several samples and subsequent data analysis to infer the annual or average waste generation.

A waste audit involves close scrutiny of each process and flow, as well as of the overall system. It is more difficult at larger scales, since it is hard to assemble accurate data for a large number of processes and waste flows and to understand the implications of interconnections. Waste audits are often executed by specialised firms on behalf of the organisations that generate the waste. However, you can also do a waste audit yourself. [Exercise 1.2](#) provides guidance for estimating the amount of food packaging waste you generate annually.

### EXERCISE 1.2 WASTE AUDIT: FOOD PACKAGING WASTE

Food packaging is a major component of MSW. With a simple waste audit, you can (roughly) estimate how much food packaging waste you generate on a yearly basis.

Create a table similar to [Table 1.2](#). In the first column, list all the foods you eat on a typical day, such as cereals, milk, pasta or rice. In the second and third columns, list the amount in a typical package, as well as the amount you eat on a daily basis. In the fourth column, calculate the fraction of a package you eat daily. In the fifth and sixth columns, list the packaging materials and the packaging weight. (You can measure the packaging weight using a kitchen scale.) In the final column, calculate your daily packaging waste by multiplying the fraction consumed with the package weight. Sum all the daily waste and multiply by the number of days in a year to estimate your annual food packaging waste generation. Is the figure higher or lower than you expected?

You can also sum the individual materials, such as paper and plastic packaging, to estimate the composition of your waste generation. What are the most common materials in your food packaging waste? What are the greatest uncertainties in your estimate? What would be the easiest way to cut down on food packaging waste?



**Table 1.2** Example table for Exercise 1.2.

Food	Package size	Daily consumption	Fraction	Type of packaging	Package weight (g)	Daily waste (g)
Cereals	500 g	50 g	0.1	Carton	20	2
				Plastic bag	2	0.2
Milk	1 l	200 ml	0.2	Carton	25	5
...	...	...	...	...	...	...

## 1.6 THE CHALLENGES OF WASTE

### 1.6.1 Waste as unwanted material

Waste is unwanted, and the waste owner desires to rid themselves of it and the inconvenience it presents. This fact is the basis for the problems presented by waste. Someone who generates waste does not want it and therefore rarely cares about its destination; waste is 'out of sight, out of mind'. They may be willing to pay someone else to take the waste away; however, since this might be costly, it could be attractive to get rid of the waste by dumping it.

If everybody dumped their waste, the pollution of the environment would be a major burden to everyone. Hence, waste presents a collective action problem: as a whole, society is better off with waste collection systems, but to individuals it may be more attractive to not pay for waste management services and instead dump the waste for free.

Government regulation is critical to prevent dumping and guarantee appropriate waste collection, treatment and disposal. To make sure the regulations are adhered to, dedicated government units and legal experts fight waste crime (See [Box 1.2](#)), but it is difficult to completely root out abuse. If you found that waste had been illegally dumped at a parking lot near your house, how would you expect officials to track down the offender? How would you find the perpetrator of waste dumped from vessels at sea?



**Figure 1.13 Would you store valuable belongings like this? These materials are deemed worthless by whoever discarded them, but they have potential value.** Image: Stijn van Ewijk.

The ‘unwantedness’ of waste and the lack of concern over its destination also lead to limited engagement with source-separation of household waste. Source-separation of waste tends to be rewarded only in the case of commercial or industrial waste generators, who may receive payment for the recyclables they generate (instead of paying a management fee to a waste collector). Again, enforcement is difficult; governments can hardly make it a punishable offence for households to throw recyclables in the trash. The challenges of regulating waste collection will be discussed in [Chapter 3](#).

### BOX 1.2 WASTE CRIME

Waste crime exemplifies the challenges of waste being unwanted. Unless waste has a high value as a recyclable, treatment is costlier than disposal. As a result, waste operators may be tempted to accept payment for treatment, storage or transport, before illegally getting rid of the waste as cheaply as possible. Although rarely immediately visible, waste crime has major environmental impacts, threatening the quality of water, soil and air. Illegal dumping may threaten wildlife habitats, which are attractive locations for dumping because they tend to be remote and with little human oversight.



The complexity of the waste industry is conducive to crime, with myriad types of waste generated, carried or treated by a very large number of organisations. Within this complex system, grey areas are easily exploited and many actors may work (knowingly or unknowingly) with parties who engage in illegal practices. The composition of waste is hard to measure or control, which leaves possibilities for illegal mixing, dilution or disguise. For example, trash may be illegally exported as a recyclable by hiding it inside bales that show only recyclables on the outside, and subsequently dumped in a developing country.

Stricter environmental regulations can prevent or reduce the impacts of waste, but they often also make it costlier to treat, dispose of or recover waste. As a result, the motivation for waste crimes increases and regulators need to step up their crime prevention efforts when introducing stricter regulations.

Waste crime often occurs across borders. Asymmetries in environmental regulation make it attractive to trade waste from rich countries with strict environmental standards (and high waste generation) to developing countries, where loose regulation and weak enforcement create a fertile ground for illegal practices. Waste crime may be interconnected with other types of crime. For example, waste dumping commonly occurs in the context of illegal drugs operations and illegal mining, not least because a legal treatment route might reveal the operation.

Waste crimes are difficult to address because they are rarely directly observed or felt by a victim. For example, the dumping of toxic waste in a water body may not be noticed until the (very serious) effects become visible much later, or until a routine quality measurement takes place. The need for cross-border collaboration between police and prosecutors makes international waste crime harder to address.

Efforts to prevent, rather than punish, waste crime include regulations that prohibit potentially problematic activities. For example, the international trade of hazardous waste is highly restricted because it is vulnerable to abuse and, due to the hazardous character of the waste, has the potential for profound environmental impacts (see also [Box 4.4](#)).

### 1.6.2 Waste as a contaminated resource

Have you heard the phrase ‘waste is a resource’? On the internet, this phrase is about four times as prevalent as the phrase ‘waste is contaminated’. Strictly speaking, waste is the opposite of a resource. The owner wants to get rid of it because it is of no use to them – it is no longer a resource. But the phrase is meant to convey that waste can be turned into a resource through treatment and



recovery, upon which it can be used again by the same person or (more often) by someone else.

Often, the greatest challenge to turning waste into a resource is contamination. Contamination occurs at various levels, as shown in [Figure 1.14](#) for recyclable paper. First, waste may be mixed with various other recoverable materials. For example, a household waste stream may contain plastics, paper, glass and metals and these all need to be sorted into separate fractions. Second, a separate fraction of a certain material includes various qualities that should be separated before recycling. For example, to avoid cross-contamination, corrugated board is ideally recycled into new corrugated board and white paper is ideally recycled into new white paper. Third, a separate fraction of any material is likely to contain trace amounts of contaminants that affect quality. For example, traces of inks, plastics and glues are found in paper for recycling. These can have both technical and environmental or human health impacts (e.g., in food-grade paper packaging such as cereal boxes).

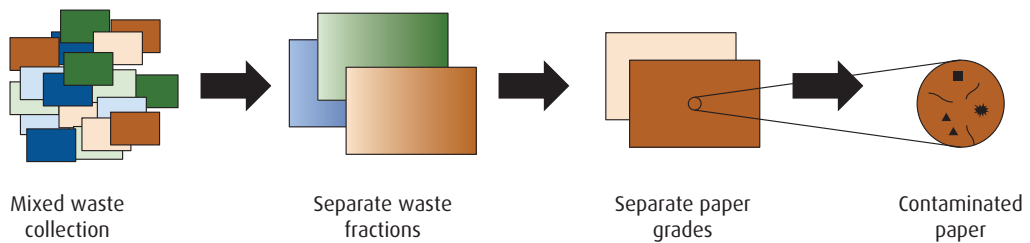

**Figure 1.14 Levels of contamination for paper.** Image: Authors' own.

The use of waste as a resource thus requires separation and decontamination. Generally speaking, better separation requires more energy, which implies a trade-off between waste recovery and energy conservation. Besides, there will be a highly contaminated residue. Sometimes this residue is valuable too, for example, when recyclable metals are removed from iron residues, but often it contains a mix of contaminants whose separation is not economically feasible. Alternatives to separation and decontamination include preventing the introduction of contaminants in products, for example, by avoiding composite material designs. Highly contaminated residues may be destroyed or concentrated through incineration or safely contained in landfill. However, the latter two options exclude material recovery.

In practice, certain levels of contamination are acceptable. In fact, most virgin alternatives also feature some form of contamination, though often these are of a

different kind. Dilution or mixing of waste may seem an attractive way of reducing the concentration of contaminants. After all, if a highly contaminated waste is mixed with a less contaminated waste or other material, the average concentration of contaminants is lower in the mixed materials. However, dilution leads to a further and almost irreversible dispersal of contaminants. Intentional dilution is therefore usually illegal in the case of potentially polluting contaminants. Nevertheless, some dilution may happen during reprocessing. For example, to reduce copper levels in steel, copper-rich scrap is diluted with virgin steel from iron ore, effectively preventing recovery of the copper (see [Box 1.3](#)).

### 1.6.3 Systemic interactions

The quantity and quality of waste is a consequence of decisions regarding the design, production, manufacturing and use of materials. More than anyone in the lifecycle of materials, waste managers must adapt to others. Whereas product designers have immense freedom in choosing materials, waste managers must deal with whatever is left at the end of the lifecycle. This makes waste management a challenging job; new materials and products enter the market continuously and waste managers must then find a way to treat and recover the waste. For example, food packaging for a single food item can include various types of paper and plastics and a variety of contaminants, including inks, and next year's packaging may be different again.

The feasibility of recovery of waste depends in part on the availability of recovery facilities and end-markets for the recovered products. However, there is no guarantee of a stable supply of waste of a constant quality. When the waste stream changes, the recovery facilities need to be adapted or replaced, and the original investment may be lost. Similarly, the end-user of the recovered material, such as a recycled paper mill taking wastepaper, can hardly bet on a stable supply of wastepaper of a constant quality. The owner of the paper mill likes to invest on a decadal scale, but the waste stream is likely to change within a shorter time period; these interdependencies lead to underinvestment in waste treatment and recovery infrastructure.

At the same time, the work of waste managers does to some extent affect production and manufacturing because secondary materials are reintroduced to the lifecycle through recycling and recovery. However, since recovered materials and products contain more contaminants, the waste resulting from using recovered materials is even harder to treat and recover. The accumulation of contaminants in the system is the consequence of systemic interactions; the level of contaminants in the waste stream, and the associated challenges for recovery, depend on a range of actions taken along the lifecycle, including design, production, manufacturing, use, collection, treatment and recovery of products and waste.

The globalisation of supply chains and waste management amplifies the challenges of waste because the cultural and physical distance between the stakeholders in the lifecycle becomes larger. The various activities, such as product design or waste collection, are regulated by different governments, leading to discrepancies in laws, policies, standards and regulations. Globalisation compounds the challenges of 'unwantedness', contamination and systemic interactions because it hinders consistent regulatory action, integrated management of contamination and a coordinated response to the systemic challenges of the material lifecycle. Some of the push for better waste management is therefore about increased coordination of global production and consumption.

### BOX 1.3 CONTAMINATION OF STEEL WITH COPPER

Good steel contains little copper; during hot forming, steel with higher copper content exhibits surface cracking. For some steel applications, such as reinforcing bar for concrete structures, copper concentrations of 0.4 weight percentage (wt%) are acceptable, but for other applications, such as car components, the concentration should be less than 0.06 wt%. Unfortunately, copper is introduced into the scrap when shredding complex products, such as cars and appliances that contain wires and motors.

The immediate solution for the copper contamination problem is to dilute recycled steel with virgin steel from iron ore and to allocate high copper melt to those steel products with a high tolerance. However, with increasing recycling rates, these practices may not be sufficient to manage global copper levels in steel in the future, and therefore limit the applications for which recycled steel can be used. There are several other options to address the issue.

1. Dilution is more effective when trading scrap globally and using it strictly for copper-tolerant steel products only.
2. Product design changes, such as for vehicles, could make copper more easily removable before shredding the steel.
3. Scrapping and removal procedures may be improved with new technologies, reducing the copper content in the scrap.
4. Copper tolerance in the steel production process could be increased through improved processing and forming.



The potential solutions illustrate the combined challenges of contamination and systemic interactions. The outlined solutions require, among others, accurate measurement of steel copper content, improved global standards for steel quality and efficient coordination of global trade. What starts out as a technological challenge in a steel plant turns out to be a systemic challenge for steelmakers, product manufacturers, waste managers, traders and governments globally.

Source: Daehn, Cabrera Serrenho and Allwood (2017).

## 1.7 SUMMARY

This chapter first discussed the many different materials we use and the continuous growth in material consumption. This growth can be analysed using the IPAT equation, which describes how impacts ( $I$ ), such as material consumption, are driven by population ( $P$ ), affluence ( $A$ ) and technology ( $T$ ). Consumption is underpinned by the human need for participation, health and autonomy, the satisfaction of which requires materials and products. These needs are timeless, but technological innovation changes how these needs are satisfied.

The anthropogenic material lifecycle describes how we take materials from the natural environment into the anthroposphere. The lifecycle stages after extraction from nature are production, manufacturing, use, treatment and recovery, and disposal. Materials may move in a linear fashion from one stage to the next but may alternatively be cycled back to earlier stages through reuse, recycling and recovery. Materials can stay in stock, such as the stock of materials in buildings, which leads to a delay between consumption and waste generation.

Waste is commonly categorised by the economic sector that generates it, for example, mining and quarrying, agriculture (and forestry and fishing), industry, construction, households and services, and waste management. Like material consumption, waste generation tends to scale with population and affluence. Waste composition and quantity can be estimated through waste surveys or as part of a mandatory reporting requirement. Waste generation and composition data is often extrapolated to obtain figures for large geographies. Waste generation can also be calculated from the difference between material consumption and stock building.

Waste management consists of the collection, treatment, recovery and disposal of waste. The top priorities indicated by the widely used waste hierarchy are prevention, reuse, recycling, energy recovery and then disposal. Waste prevention is distinct from waste management because it involves only activities that occur before materials and products become waste. In practice, waste management

diverts from the waste hierarchy because of various social, technical, economic and environmental constraints. Waste auditing can be used to identify opportunities for improvements in production and waste management processes.

Waste poses unique challenges. First, waste is essentially unwanted, which makes it hard to ensure safe collection, treatment and recovery. Second, waste is contaminated and even upon decontamination may not be able to fully substitute virgin resources. Finally, waste is the consequence of decisions made across the lifecycle and the mixed waste stream is the combined result of myriads of lifecycles. Waste prevention and management therefore require coordination across lifecycles, industries and countries.

## **1.8 REVIEW**

- 1.** Give examples of materials and products in the four main material categories.
- 2.** Describe trends in steel consumption using the concept of human needs.
- 3.** Explain the anthroposphere and the main stages of the material lifecycle.
- 4.** Describe the main stocks and flows in the lifecycle of a smartphone.
- 5.** List the main categories of waste and comment on their prevalence.
- 6.** Describe how you would conduct a waste audit for a fast-food restaurant.
- 7.** Explain the main components of waste management and the waste hierarchy.
- 8.** Reflect on the role of the waste hierarchy in an efficient or circular system.
- 9.** Explain the consequences of waste being both unwanted and contaminated.
- 10.** Describe which systemic interactions complicate plastic water bottle recycling.

# 2

# THE IMPACTS OF WASTE

## LEARNING OBJECTIVES

After studying this chapter, you should be able to:

- define the concepts of the natural environment and sustainability
- list the main environmental impacts of material use and waste
- discuss the social impacts of waste generation and management
- explain economic distinctions between materials and waste

## 2.1 INTRODUCTION

Production and consumption have both positive and negative consequences for the economy, society and the environment. Positive consequences include economic growth and employment, increased standards of living and services such as advanced healthcare. The ‘impacts’ of production and consumption generally refer to negative consequences, which include economic costs and losses, human health risks and environmental degradation. These negative consequences are unintended and sometimes unforeseen and ill understood.

Waste constitutes a dual environmental problem. First, there are the negative impacts on the environment and human health from the littering, dumping, collection, treatment and disposal of waste. These activities lead to the pollution of the air, water and soils. For example, the transport of waste in fossil-fuel-burning trucks leads to air emissions; leachates from landfills can pollute groundwater. These types of impacts can be reduced through waste prevention and the use of cleaner collection, treatment and disposal technologies, such as electric trucks and well-designed landfills.

Waste also implies the potential loss of natural resources. For example, disposing of old furniture means that the materials, which were once extracted from the natural environment, are not in use anymore and are possibly lost forever. The loss of resources may be lessened by turning the waste into a resource again through material or energy recovery, such as by refurbishing furniture or burning it in a biomass energy plant. This reintroduces the waste as a resource into the economy. Moreover, the loss of natural resources can be prevented by using products for longer, which is a form of waste prevention.

The two environmental problems – negative impacts and loss of resources – are strongly related because waste that is a bigger threat to the environment and human health is often also harder to recover. Good waste management aims to simultaneously address both problems by reducing the contamination levels and quantities of wastes using treatment, recovery and disposal technologies with

minimal environmental impacts. Waste management is most successful when it has low impacts and reduces the need for virgin materials through waste recovery.

Waste tends to be seen as an environmental problem but also presents a social and economic issue. This chapter will reflect on waste from all three angles. The chapter first discusses the concept of sustainability, which includes economic, social and environmental dimensions, and the role of the natural environment (Section 2.2). It then proceeds with a discussion of the environmental impacts (Section 2.3), the social impacts (Section 2.4) and the economics of waste (Section 2.5). The next chapter will look at methods for assessment of all these types of impacts.

## 2.2 SUSTAINABILITY AND THE ENVIRONMENT

### 2.2.1 What is sustainability?

This chapter's focus on the environmental, social and economic impacts of waste is drawn from the concept of sustainability and its environmental, social and economic domains. There are many definitions of sustainability, all of which focus on maintaining or improving the conditions for life on earth. Sustainable development emphasises our long-term obligations to respect the needs of future generations, as well as the economic, social and environmental conditions required to meet them. The influential 1987 Brundtland Report formulated sustainable development as 'development that meets the needs of the present without compromising the ability of future generations to meet their own needs'. This is a human-centric definition, focusing on the role of living systems for human wellbeing.

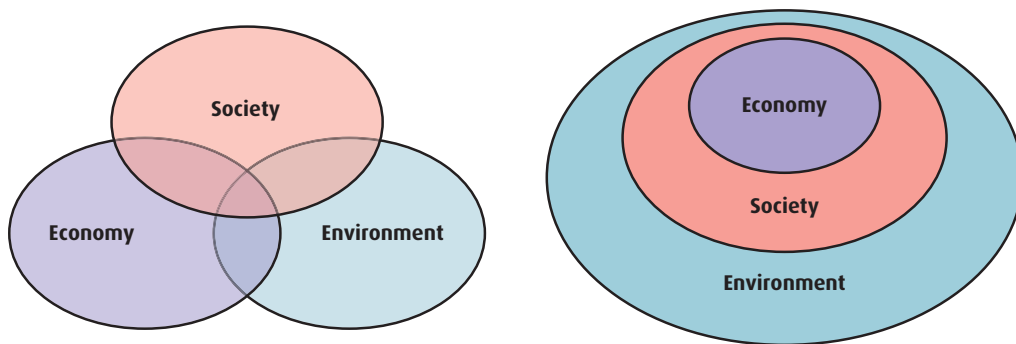

**Figure 2.1** Overlapping and embedded domains of sustainability. Image: Authors' own.



[Figure 2.1](#) presents two depictions of the three domains of sustainability. On the left, it shows equal overlaps between society, the economy and the environment. In the middle is the ‘sweet spot’ of sustainability, combining good performance in all dimensions. This depiction is consistent with the widespread concept of ‘people, planet, profit’ (coined by John Elkington in the early 1990s) but implies that good performance in one dimension is separable from the others. Is it actually possible to combine good social performance with bad environmental performance? For example, could a company that generates a lot of air emissions but that treats its employees well be considered both a polluter and socially responsible?

Perhaps you are inclined to answer this question affirmatively. But think of those whose health and wellbeing are affected by the emissions; would they consider the company to be socially responsible? In practice, social and environmental performance are inextricably linked because we – society – need a healthy environment. Another question is whether we can do well economically while doing badly environmentally. For example, can we be rich while rapidly cutting and degrading a forest? Cutting forests can indeed be profitable, but not in the long run, because the trees regrow only slowly. Again, the economy and the environment turn out to be inextricably linked.

The last question is whether we can do well economically while doing badly socially. This may indeed be possible, but an economy that does not make us better off socially – in terms of relationships, fairness, meaning and happiness – scarcely serves us at all. We would instead be better off by seeking to build an economy that fulfils our needs for participation, health and autonomy (see [Section 1.2.3](#)). At the same time, to fulfil all these needs, we may not necessarily need a very high level of economic output, since studies have shown that being wealthier only makes people happier up to certain income levels. Beyond this, happiness plateaus (Jebb et al. 2018; Easterlin et al. 2010).

The relationship between the three domains can also be represented by the right-hand diagram in [Figure 2.1](#), which shows the three domains of sustainability as embedded layers. In this depiction, the economy serves society, and both are constrained and supported by the natural environment, which is crucial for our health, wealth and wellbeing. This depiction is not perfect either, but it communicates that economic, social or environmental performance cannot be entirely divorced from each other. It also shows that we must respect the limits of the natural environment, such as the finite amounts of space, solar irradiation and mineral deposits that underpin life on earth.

## 2.2.2 The natural environment

Environmental impacts are changes to the environment. But what exactly is the environment and what changes do we make to it? The environment can be

divided into four spheres: the lithosphere (the earth's crust), the hydrosphere (all water on the planet), the biosphere (all life on earth) and the atmosphere (the air around us). An impact, in this view of the environment, is a change in one or more of the spheres. For example, fertiliser runoff can increase phosphorus levels in a lake, which constitutes an impact to the hydrosphere. This in turn affects the health and survival of aquatic species, which are part of the biosphere.

Some of the most useful conceptualisations of the natural environment focus on the relationship between people and the environment. Most prominently, the Millennium Ecosystem Assessment (MEA) conceptualised the environment according to what it does for human beings, for the purpose of understanding how changes in the natural environment affect us. The MEA identified four categories of 'ecosystem services', which are the benefits people obtain from ecosystems. They can be directly linked to the components of human wellbeing, which the MEA defines as security, basic materials for a good life, health, social relations and freedom of choice and action.

- *Provisioning functions* cover the products that ecosystems supply, which include materials, food, water and fuels.
- *Regulating functions* include the processes that ensure, among others, a stable climate, water purification, flood regulation and disease regulation.
- *Cultural functions* can be aesthetic, spiritual or educational, and include recreational enjoyment of the environment.
- *Supporting functions* cover, among others, nutrient circulation, soil formation and photosynthesis, and underpin the other functions.

The MEA shows how the natural environment practically serves human beings but omits other aspects of our relationship to the natural environment. The conceptual framework by the Intergovernmental Platform on Biodiversity and Ecosystem Services (IPBES) goes beyond an instrumental (functional) description of nature by including the following:

- *Intrinsic value* is the inherent value of nature, irrespective of how it affects human beings. It can be compared with the intrinsic value of a human being, which we consider independent of how it serves other human beings.
- *Relational value* describes the meaningfulness of our relationship with nature. It can be compared with relationships between humans, the meaning of which also transcends beyond the instrumental value.

To preserve the natural environment, we need an idea of its vulnerability to pressures created by humans. [Figure 2.2](#) presents an influential overview of environmental limits at the global level and the extent to which they are exceeded. For example, it indicates ‘increasing risk’ regarding climate change because current trajectories of greenhouse gas (GHG) emissions suggest significant global warming in decades to come, which will affect climate and weather patterns globally and will contribute to droughts and extreme weather events. The limits that are most critically endangered relate to biodiversity and the flows of phosphorus and nitrogen, both of which are very important for ecosystem functioning and agricultural production. A more elaborate description of these and other impact categories is provided in [Table 2.1](#).



**Figure 2.2 The planetary boundaries framework.** J. Lokrantz/Azote, based on Steffen et al. (2015).

At the local and regional levels, various other environmental limits are relevant, which is reflected in many environmental regulations. For example, among many others, there are limits for toxic metals in soils, chemicals in discharges to rivers, carbon monoxide (CO) in indoor air, contaminants in recycled food packaging, pesticides on crops and antibiotics in milk. Perhaps confusingly, these limits sometimes refer to a part of the natural environment, such as soils, but also to man-made products, such as recycled packaging. The [next section](#) discusses a framework that helps understand the complexity of the causal chain of environmental impacts and the relevant thresholds or contested evidence.

## 2.3 THE ENVIRONMENTAL IMPACTS OF WASTE

### 2.3.1 The DPSIR framework

The DPSIR framework offers a practical approach for analysing environmental impacts. The framework can be used to identify the drivers, pressures, states, impacts and responses (DPSIR) associated with what may be loosely defined as an ‘environmental problem’. [Figure 2.3](#) presents the framework; the DPSIR elements are shown in boxes and their causal relationships are shown with arrows. The five elements of the DPSIR framework can be described as follows:

- *Driving forces* describe social, demographic and economic developments and the corresponding changes in lifestyles, consumption and production. For climate change, an example driver is landfilling of organic waste.
- *Pressures* describe developments in the release of waste and emissions, physical and biological agents and the use of resources and land. The pressure associated with organic waste in landfill is the production of methane (CH<sub>4</sub>, a potent GHG) emissions when the waste decomposes.
- *State* indicators describe the quantity and quality of physical, biological and chemical phenomena that reflect the quality of the environment. In the example of climate change, state can refer to the concentration of GHGs in the atmosphere.
- *Impact* indicators describe changes in human and ecosystem health, resource availability, losses of goods and services, and biodiversity. Climate change leads to lower crop yields due to droughts and to flooding due to sea level rise.
- *Response* indicators refer to attempts by individuals or groups to prevent, compensate or adapt to changes in the state of the environment. In response to climate change, some countries have banned the landfilling of organic waste.

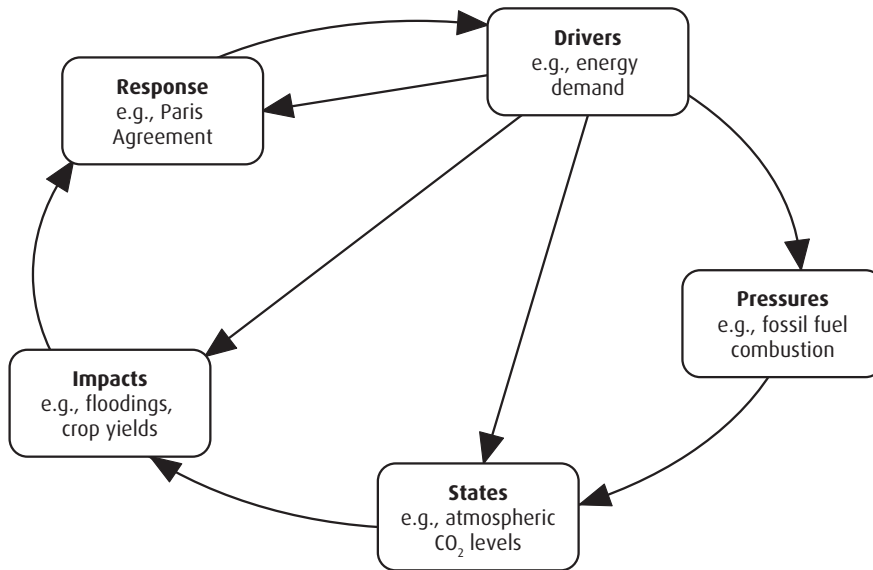

**Figure 2.3 The DPSIR framework.** Redrawn from Gabrielsen and Bosch (2003).

The arrows in [Figure 2.3](#) show that responses can affect not only drivers (such as landfilling of organic waste) but also pressures, states and impacts. An example of a measure that addresses the impacts of climate change is the reinforcement of coastal barriers in low-lying coastal zones to cope with the flood risk stemming from sea level rise and extreme weather events.

Can you tell whether the following responses to climate change are targeting drivers, pressures or states?

1. Planting new forests to store carbon in trees.
2. Capturing and converting methane from landfill into CO<sub>2</sub> (a less potent GHG).
3. Using biofuels instead of petrol in cars.

You probably concluded that a shift to biofuels addresses drivers, while capturing landfill methane addresses pressures. Reducing carbon in the atmosphere by planting forests changes the state of the environment. Still, the interpretation of the DPSIR framework may differ between analyses and analysts. For example, drivers can be defined variously; organic waste to landfill is driven by the consumption of organic materials, which in turn is driven by demand, which may in turn be driven by population growth (remember the IPAT equation in

Section 1.2.2). While the framework can be used flexibly, it should at least be consistently applied within a single study.

### 2.3.2 Types of environmental impacts

Figure 2.4 summarises some of the impacts of waste using the DPSIR framework. The drivers correspond with all the activities in the material lifecycle shown in Figure 1.3. The drivers lead to pressures, which include emissions to the environment and extractions from it, which in turn lead to a new state of the environment. The figure shows a selection of emissions and resources; for example, it includes carbon dioxide (CO<sub>2</sub>) but not methane (CH<sub>4</sub>, the second-most-abundant greenhouse gas). The new state of the environment has impacts on three ‘areas of protection’: human health, the natural environment and natural resources. The responses, which include waste prevention and recycling, are left out of the figure, but they will be discussed in later chapters.

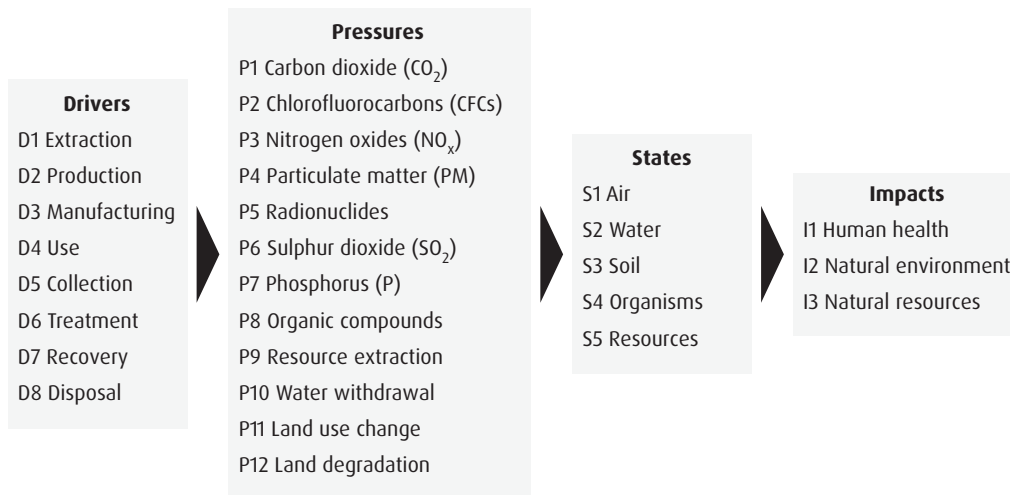

**Figure 2.4 Drivers, pressures, states and impacts for the material lifecycle.**

Image: Author's own.

Environmental problems, such as climate change or ozone depletion, are defined by a specific combination of drivers, pressures, states and impacts. Table 2.1 provides an overview of major environmental problems. These problems are widely studied because they are relevant and relatively well understood.

The listed problems coincide with the environmental impact categories typically covered in lifecycle assessment (see also [Section 3.3](#)). [Figure 2.4](#) and [Table 2.1](#) essentially cover the same content but based on different terminology. If you understand the content of both [Figure 2.4](#) and [Table 2.1](#) well enough, you should be able to link their contents in [Exercise 2.1](#).

**Table 2.1 Major environmental problems typically covered in lifecycle assessment.**

Impact category	Description
Climate change	Air emissions, mostly CO <sub>2</sub> , lead to higher radiative forcing in the atmosphere and average warming, affecting ecosystems, biodiversity and humans (flooding, malnutrition, heat stress, infectious disease).
Stratospheric ozone depletion	Air emissions, including chlorofluorocarbons (CFCs), lead to the breakdown of ozone in the stratosphere, resulting in increased ultraviolet (UV) irradiation, damaging flora, fauna and humans (immune suppression, skin cancer, cataracts).
Human toxicity	Ingestion or inhalation of toxic elements or compounds in air, soil and water leads to health issues due to the compounds being, among others, irritating, corrosive, carcinogenic and neurotoxic.
Particulate matter	Inhalation of fine particles of 10 micrometres and smaller by humans leads to respiratory problems and causes or aggravates lung and heart problems, while also affecting water, soils, crops, forests and ecosystems.
Ionising radiation	Inhalation or ingestion of radionuclides by humans increases chances of cancer and hereditary genetic mutations; internal irradiation and bioaccumulation can also damage ecosystems.
Photochemical ozone formation	Emissions of mainly nitrogen oxides (NO <sub>x</sub> ) and hydrocarbons, due to incomplete combustion of fossil fuels, lead to increased ozone levels and smog, affecting human health, forestry, crops and ecosystems.
Acidification	Deposition of air emissions, such as sulphur dioxide (SO <sub>2</sub> ), mainly from fossil fuel combustion, affect soils, biodiversity and bioproductivity, most prominently as forest dieback from 'acid rain'.
Eutrophication	An excess of nitrogen and phosphorus, often from fertiliser, in water and soils affects vegetation and crops, and aquatic species through algae growth, leading to changes in terrestrial, freshwater and marine ecosystems.
Ecotoxicity	Exposure to toxic elements and compounds from air emissions, wastewater discharges and fertiliser, and contaminated soils, air and water leads to damage to marine, freshwater and terrestrial ecosystems, as well as loss of biodiversity.
Land use	Land use change and cultivation methods affect soils, flora and fauna, and can lead to loss of soil quality, desirable landscapes or sites, and loss of ecosystems and biodiversity.
Resource depletion	The extraction of fossil fuels, ores and industrial minerals, and construction minerals reduces the availability and increases the prices of materials; withdrawal of freshwater can lead to local water shortages and droughts.

### EXERCISE 2.1 MATCHING IMPACT CATEGORIES AND DPSIR

Match the description of each impact category in [Table 2.1](#) with the numbered pressures, states and impacts in [Figure 2.4](#). For example, eutrophication from fertiliser runoff in agriculture corresponds with the *driver* of production (D2), the *pressure* of phosphorus (P7), the *state* of water (S2) and *impacts* on the natural environment (I2). Organise your answers in a table with the impact categories in the first column and the relevant numbered entries for drivers, pressures, states and impacts in the subsequent columns.

Completing [Exercise 2.1](#) reveals that a single impact category can relate to various drivers, pressures, states and impacts. At the same time, the drivers, pressures, states and impacts can be identified at different spatial scales. For example, for climate change, the pressures are often point sources of air emissions, such as landfills, and therefore local. The relevant state of the environment is measured as the concentration of CO<sub>2</sub> equivalents (CO<sub>2</sub>eq) in the atmosphere, which is global. The impacts occur at various scales, with temperature rise affecting crop yields across the globe and sea level rise affecting coastal regions and low-lying islands.

### BOX 2.1 DISENTANGLING ENTANGLEMENT

Images of marine animals entangled in plastics, initially most influentially in the documentary series *Blue Planet*, have put marine litter squarely on the political agenda. Though the images have done a great job of flagging the issue, the measurement of the impacts of plastic pollution is not at all straightforward, requiring a thorough understanding of the fate of plastics, their effect on marine species and the resulting ecosystem damage.

Various studies have looked at the amount of plastic that is currently in rivers and oceans. Scientists know approximately how much plastic is released annually into the oceans and how much is, again approximately, fed by rivers into the oceans. They also know which catchment areas and rivers are likely to contribute the most plastics to the oceans based on population densities, concentrations of economic activity and local (lack of) waste collection practices.

Marine plastic litter can affect species through habitat alteration and destruction, introduction of non-native species (which 'raft' on the plastic debris), ingestion by





marine animals and even entanglement. The extent to which these effects are problematic is largely unknown; for example, researchers do not know how many animals suffer entanglement, nor whether ingestion of small quantities affects animals' health.

Clearly, there are many challenges to be overcome before we can confidently establish the environmental impacts of marine litter. There is also a question as to whether 'marine litter' should constitute a separate impact category or whether it should be integrated with existent ones. For example, ingestion of toxic plastics could fall under 'ecotoxicity' since this describes, among others, water pollution affecting species survival.

Source: Sonnemann and Valdivia (2017); Woods, Rødder and Verones (2019); Lebreton et al. (2017); Jambeck et al. (2015).

### 2.3.3 Pollutants and hazards

The previous two sections focused on the identification and categorisation of environmental impacts. The present section discusses specific pollutants and hazards, many of which will be referenced in later chapters. Pollutants may be associated with the wastes themselves, or may arise due to physical, chemical and biological processes that occur as the waste is stored or processed for treatment or recovery, or both.

The hazards presented by the wastes discussed in this section are summarised in Table 2.2. The hazardous properties of waste are diverse and may not be obvious from how the waste looks, smells or feels, which makes the waste all the more dangerous. Waste that exhibits hazardous properties is often classified as such and is regulated more strictly. Section 4.3.3 explains further how regulatory frameworks deal with hazardous waste. Common pollutants include the following:

- *Biodegradable organic matter* is problematic when discharged to water because its degradation by aerobic micro-organisms reduces the availability of the oxygen needed for the respiration of larger aquatic animals.
- *Nitrogen and phosphorus* are nutrients for growth of algae and other plants. Excessive nutrient discharge to natural waters causes eutrophication and ecologically unbalanced and unsustainable plant growth, which leads to oxygen depletion when the plants die (thereby becoming biodegradable organic matter, as described above).

- *Volatile organic compounds* (VOCs) have low boiling points and therefore evaporate into the gas phase. Apart from their health impacts, they may react with nitrogen oxides in the air to produce photochemical smog. VOCs include thiols and other smelly sulphur-containing compounds, as well as benzene, toluene, ethylbenzene and xylene (BTEX), which are associated with fuels and petrochemical processing. VOCs also include solvents, such as trichloroethylene (TCE) and perchloroethane ('perc'), which are used in dry-cleaning and industrial processes.
- *Products of incomplete combustion* include polycyclic aromatic hydrocarbons (PAHs), dioxins and furans (which may also be formed during the manufacture of herbicides and in the pulp and paper industry), carbon monoxide (CO) and soot. All these products are associated with health impacts, and soot also contributes to climate change, either as a component of the atmosphere or when deposited onto snow and ice surfaces, subsequently absorbing solar radiation.
- *Persistent organic pollutants* (POPs) are chemically stable synthetic compounds that do not break down in the environment. They are absorbed from water and soil by plants and lower animals and tend to accumulate to more harmful levels in higher animals through the food chain. They include many products of incomplete combustion and also polychlorinated biphenyls (PCBs), which are now widely banned but which continue to persist in waste dumps and contaminated environmental media. POPs also include pesticides and herbicides, their chemical precursors and byproducts, and perfluoroalkyl and polyfluoroalkyl substances (PFAS), which are used in a variety of consumer products, such as non-stick cookware, stain retardants and fire retardants.
- *Toxic metals*, such as arsenic, cadmium, chromium, copper, lead, mercury, nickel and zinc, are harmful to human or ecological health.
- *Acids*, such as hydrochloric acid (HCl) or sulphuric acid (H<sub>2</sub>SO<sub>4</sub>), or bases, are common in industrial processes (e.g., titanium production or metal finishing). Acids and bases are corrosive as they have a pH much lower or higher (respectively) than the typical environmental pH of 6–8. They may also be contaminated with toxic metals.
- *Dust* arises from many waste treatment activities, such as the shredding of metal products, the movement of contaminated soils or the storage of ashes. It can be damaging to eyes, skin and respiratory organs.
- *Ammonia* (NH<sub>3</sub>) gas results from anaerobic degradation of proteins during the storage and treatment of organic waste. It becomes the toxic

ammonium ion ( $\text{NH}_4^+$ ) dissolved in water. Ammonia can cause severe skin burns and respiratory irritation and is toxic to aquatic species and plants.

- *Hydrogen sulphide* ( $\text{H}_2\text{S}$ ) gas may be generated during the storage or treatment of organic waste. As it is denser than air,  $\text{H}_2\text{S}$  tends to collect at and below ground level. Even at concentrations of just 0.1 per cent, its inhalation is almost immediately fatal, and the gas is still harmful to health at much lower concentrations.
- *$\text{CO}_2$  and methane*, which were already mentioned in previous sections, result from the thermal treatment of waste and the decomposition of organic matter, with methane more prevalent in oxygen-starved processes such as anaerobic digestion and the decomposition of organic waste in deep landfills.

Although waste may appear to be liquid (for example, pumpable effluents) or solid (such as ashes or contaminated soil), it is often a mixture of solids and water. Waste with a moisture content under 40 per cent usually appears solid, and some waste even appears solid with a moisture content as high as 80 per cent. The pollutants in the waste are usually partitioned between the solid and the liquid, depending on their affinity for water (hydrophobic or hydrophilic) and the chemical environment. Some pollutants, such as ammonia and VOCs, also partition significantly into the gas phase, making them particularly hard to contain and posing risks of inhalation.

Various local environmental impacts have not been addressed so far; a selection of such local impacts is listed below.

- *Noise*. The noise from transport and the operation of equipment can be a significant nuisance for nearby residents and visitors.
- *Aesthetics*. Large facilities change the view for residents and visitors and may render the local environment less attractive.
- *Odour*. Unpleasant smells can arise from industrial and waste facilities, including from chemicals and decaying (waste) organic matter (VOCs,  $\text{NH}_3$ ,  $\text{H}_2\text{S}$  and thiols).

All the above refer to impacts that occur during the normal operation of waste facilities. Further impacts may be caused by accidents at waste facilities, whether completely unintentional or through deliberate mismanagement. While accidents are infrequent, their impact can be large. Examples of waste-related accidents include mining waste dam breaks and other unintentional releases of waste, and

fires and explosions at waste storage, recovery and disposal sites. The collection of waste can also be dangerous, with garbage collectors suffering some of the highest fatal injury rates of any job, largely due to workers getting struck by traffic.

**Table 2.2 Hazardous properties of waste as literally defined by the Waste Framework Directive (emphasis added). EC (2008a).**

<b>Explosive:</b> substances and preparations which may explode under the effect of flame or which are more sensitive to shocks or friction than dinitrobenzene.
<b>Oxidizing:</b> substances and preparations which exhibit highly exothermic reactions when in contact with other substances, particularly flammable substances.
<b>Highly flammable:</b> liquid substances and preparations having a flash point below 21 °C (including extremely flammable liquids); substances and preparations which may become hot and finally catch fire in contact with air at ambient temperature without any application of energy; solid substances and preparations which may readily catch fire after brief contact with a source of ignition and which continue to burn or to be consumed after removal of the source of ignition; gaseous substances and preparations which are flammable in air at normal pressure; substances and preparations which, in contact with water or damp air, evolve highly flammable gases in dangerous quantities.
<b>Flammable:</b> liquid substances and preparations having a flash point equal to or greater than 21 °C and less than or equal to 55 °C.
<b>Irritant:</b> non-corrosive substances and preparations which, through immediate, prolonged or repeated contact with the skin or mucous membrane, can cause inflammation.
<b>Harmful:</b> substances and preparations which, if they are inhaled or ingested or if they penetrate the skin, may involve limited health risks.
<b>Toxic:</b> substances and preparations (including very toxic substances and preparations) which, if they are inhaled or ingested or if they penetrate the skin, may involve serious, acute or chronic health risks and even death.
<b>Carcinogenic:</b> substances and preparations which, if they are inhaled or ingested or if they penetrate the skin, may induce cancer or increase its incidence.
<b>Corrosive:</b> substances and preparations which may destroy living tissue on contact.
<b>Infectious:</b> substances and preparations containing viable micro-organisms or their toxins which are known or reliably believed to cause disease in man or other living organisms.
<b>Toxic for reproduction:</b> substances and preparations which, if they are inhaled or ingested or if they penetrate the skin, may induce non-hereditary congenital malformations or increase their incidence.
<b>Mutagenic:</b> substances and preparations which, if they are inhaled or ingested or if they penetrate the skin, may induce hereditary genetic defects or increase their incidence.
Waste which releases <b>toxic</b> or <b>very toxic</b> gases in contact with water, air or an acid.
<b>Sensitizing:</b> substances and preparations which, if they are inhaled or if they penetrate the skin, are capable of eliciting a reaction of hypersensitization such that on further exposure to the substance or preparation, characteristic adverse effects are produced.
<b>Ecotoxic:</b> waste which presents or may present immediate or delayed risks for one or more sectors of the environment.
Waste capable by any means, after disposal, of <b>yielding another substance</b> , e.g., a leachate, which possesses <b>any of the characteristics listed above</b> .

## 2.4 THE SOCIAL IMPACTS OF WASTE

### 2.4.1 Waste and social norms

Understanding the social impacts of waste starts with how we view waste. Social norms dictate that waste is ‘dirty’ or ‘unhygienic’, even if it has no physical properties that clearly justify this evaluation. The negative judgement of waste extends to waste infrastructure and waste workers – cleaners, garbage truck workers and businesses that deal in recovered materials or second-hand products tend to have a low social status. These social norms are very influential and affect attitudes and behaviour beyond what can be expected from an evaluation of the physical properties of waste.

From the perspective of waste collection and recovery, it is unfortunate that waste generally receives a negative response. People tend to overestimate the extent to which used products or waste are somehow worse than new products. For example, food that is past its ‘best before’ date is only less fresh – it may not have gone off. Unless spoiled, foods that lack their original freshness are rarely less healthy than processed sugary foods that were never ‘fresh’ in the first place; yet we are more afraid of ‘waste’ food than food that is obviously bad for us.

In short, our attitudes towards waste are partly shaped by social norms and not just by the physical material properties. At the same time, for some product categories, excess or waste is even considered desirable. In some cultures, finishing your plate can be interpreted as a sign that the host has not provided enough food – the norm, therefore, is to leave some food uneaten. In other cultures, it can be considered rude to not finish your plate, not because of the waste, but because it suggests a lack of appreciation of the food.

In short, waste is associated with poverty and ill social standing, which makes it difficult to engage consumers and businesses with waste prevention and recovery efforts. The activities associated with waste management are often left to marginalised groups, and waste facilities are often built near marginalised communities. The [next section](#) reflects further on these patterns, while [Box 2.2](#) shows a rare occasion of waste being celebrated, albeit only for the convenience it offers in the context of single-use disposable household items.

## BOX 2.2 THROWAWAY LIVING

The 1 August 1955 issue of the American magazine *Life* (only 20 cents!) features a cover story on the Geneva Summit, where the four great powers met to defuse the rising tensions of the Cold War. The reader was also offered a more light-hearted article on 'throwaway living', which, according to the subtitle, cuts down household chores. The accompanying photo shows items such as plates, diapers and napkins that together would have taken forty hours to clean – fortunately, 'no house-wife need bother', since all of it can be binned. The article highlights various products: a dog bowl with reusable stand and six dishes for \$1; the 'disposapan' with a reusable frame and eight pans for \$2.98. The disposable barbecue still exists (though current prices exceed \$0.79) but the early design marks the evolution of our knowledge of environmental impacts; the shell was made of the material asbestos, which today is largely banned because the fragments can cause cancer.

Source: *Life* (1955).

### 2.4.2 Inequality and waste

The [previous section](#) explained that social norms affect waste behaviour. The reverse is also true; waste affects us socially, due to the combination of waste being physically and symbolically dirty. Waste can be physically 'dirty' because it may be smelly, toxic and dangerous to work with; it can be symbolically 'dirty' because of the aforementioned negative connotations. Together, this has often led people to distance themselves from waste if they can afford it, with the burden subsequently falling on poorer people.

The most obvious example of distancing is the shipment of waste from rich countries to poor countries; the unwanted materials are transported to be processed by people who have few alternative jobs to choose from and are not in a position to demand better payment or reject unsafe and unhealthy working conditions. There is an economic logic that explains this, but the unfortunate result is that waste from rich people is processed under social and environmental conditions unacceptable in developed countries, despite international efforts to minimise such waste trade (see also [Box 4.4](#)).



**Figure 2.5** An informal waste worker separates recyclables on a waste truck in Mexico City. Image: Louise Guibrunet.

Even within rich countries, waste workers tend to be from marginalised communities, often working for low pay and under barely acceptable working conditions. For example, in the UK, a study showed that MRFs rarely employed local people, not even in areas with high unemployment, but rather migrant labour from poorer member states of the European Union, with jobs often exclusively done by selected minorities (Gregson et al. 2016). At the same time, waste facilities, including incinerators, landfills and hazardous waste sites, tend to be located closer to disadvantaged communities, even though they tend to produce less waste.

In low- and middle-income countries, there are large numbers of informal waste workers who operate individually or in small businesses, are not registered and are not officially tasked with waste management. They are involved mostly in the collection of recyclables, on the streets or on waste dumps, and make a living selling recyclables. The workers are often migrants and from groups vulnerable to exploitation, including women and children. Informal waste workers make an important but little acknowledged contribution to waste management. Recognition of informal waste workers could improve the social conditions and efficiency of waste management, yet they are often ignored or shunned by policymakers (Box 2.3).



### BOX 2.3 INFORMAL WASTE WORK IN MEXICO CITY

With around nine million inhabitants, Mexico City produces around 13,000 tonnes of solid waste every day. The municipality employs waste truck drivers, their assistants, called 'pawns', and street sweepers to collect this waste. These are formal workers but they also earn an informal income by selling items from the truck and through tips from local residents.

Close to a third of the waste is potentially recyclable and the majority of the recycling effort is by informal waste-pickers who work on the streets or have gained informal consent to work in buildings or on the waste truck (Figure 2.5). They carry waste in trolleys or on their backs and sell it during the day for lack of storage space. The collected recyclables are processed in – again informal – recycling workshops.

A study on informal waste workers in Tepito, a neighbourhood of Mexico City, reveals the profiles of some of the waste-pickers, one of whom

*... became a waste-picker as a child. Escaping from her abusive parents, she arrived in Tepito alone when she was eight years old and lived in the street. She made a living by collecting organic waste and selling it to animal owners, who used it as feed. Over sixty years later, she is a great-grandmother, and still supports herself and some of her grandchildren and great-grandchildren by picking waste ...*

Other waste-pickers in the study were also from vulnerable groups, struggling with, among other issues, drug addiction, homelessness, disability and criminal records. To these marginalised groups, who rarely find formal jobs, waste-picking is a last resort. Some waste-pickers nevertheless take pride in the work as a dignified alternative to stealing, begging or prostitution.

Poverty is an important factor shaping the informal waste work in Tepito. A lack of resources at the municipal level, and a large group of poor people, creates conditions for informal waste work, including the sweeping of streets inaccessible to trucks because of informal markets blocking the roads. The antagonism between the community and the local government has strengthened community ties and enables the complex organisation of informal waste work.

The informal recycling system achieved a landfill diversion rate of 20 per cent in Tepito, but at the cost of the health and safety of many waste workers. Policymakers largely feel justified in excluding informal waste workers from policymaking and sometimes refer to them as a 'mafia'. However, the informal system supports the formal one, and greater recognition of informal workers may improve the informal sector's working conditions and the system's environmental performance.

Source: Guibrunet (2017).



### 2.4.3 Categories of social impacts

The previous sections focused on the stigma associated with waste and waste work. The social impact of waste can also be viewed from a very practical angle: the ways in which waste-related activity directly affects people's lives. This angle is typically employed for the purpose of planning, design and operation of waste facilities.

The following list was adapted from guidance documentation on assessing social impacts (Vanclay et al. 2015). It presents important aspects of human life, changes to which can be labelled as 'social impacts'. The list includes examples for a nuclear waste site selection process that was conducted in Australia, based on a number of newspaper articles (Opray 2017; Medhora 2016; Wahlquist 2016). The examples show not only the potential impact of a nuclear waste facility, but also the impacts of the process for shortlisting sites (which occur irrespective of whether a site is ultimately chosen). Social impacts relate to the following:

- *Way of life*. This is how we spend our lives on a day-to-day basis: our work, leisure activities and social interactions. At one shortlisted location for the nuclear waste site, it was said that introduction of the site would create new jobs.
- *Culture*. This describes our shared beliefs, customs, values and language. The shortlist of nuclear waste sites included a site close to a significant cultural site for Indigenous peoples, which led traditional owners to strongly object.
- *Community*. This describes how we live together and covers the cohesion, stability and character of a community and the available services and facilities. Even before a decision was made, being shortlisted as a nuclear waste site caused great division in many communities.
- *Political systems*. These help people co-decide about their lives and provide democratic rights. Some local residents were greatly concerned about how information on the waste sites was supplied to residents and how the consultation was run.
- *Environment*. The environment affects the quality and availability of air, water and natural resources. An activist opposing the nuclear waste disposal site pointed out that 'there's always the chance of accidents'.
- *Health and wellbeing*. This captures the absence of disease and infirmity but also physical, mental, social and spiritual wellbeing. For one resident, hearing that a nearby site had been shortlisted for nuclear waste disposal 'felt like hearing news of a death'.
- *Personal and property rights*. This includes rights to property and civil liberties such as freedom of speech. The nuclear waste siting process was plagued by claims of incomplete information or a lack of consultation with residents.

- *Fears and aspirations.* This includes perceptions of safety and fears and aspirations for the future. The nuclear waste disposal siting process caused great distress regarding the near future among local residents at the shortlisted siting locations.

Some of the social impacts strongly relate to economics, such as employment and property rights, whereas others are almost exclusively of a social nature. At the same time, the list includes the environment again because the environment affects both the economy and society, as argued in the description of sustainability in [Section 2.2.1](#). In short, all three dimensions are connected, and the analyst must identify a workable, rather than a perfect, categorisation of impacts. Another example of a waste site and its social impacts is provided in [Exercise 2.2](#), which is about a landfill in Brazil.

### EXERCISE 2.2 SOCIAL IMPACTS OF CLOSING JARDIM GRAMACHO LANDFILL

Watch the movie *Waste Land* by Lucy Walker and get to know some of the workers at the Jardim Gramacho landfill in Brazil, which was formally closed two years after the release of the film. Using the list of social impacts provided in this section, can you describe what the closure of the landfill may have meant for the workers? What possible scenarios can you think of to make the landfill closure beneficial to both the workers and the environment? If you are interested in what happened after the time period covered in the movie, look online for the article ‘SOS Jardim Gramacho Mobilizes Residents and Recycling Cooperatives at Former Mass Landfill Site’, published by *RioOnWatch*.

## 2.5 THE ECONOMICS OF WASTE

### 2.5.1 Waste versus non-waste

The economics of waste – the flows of money associated with waste – are important to understand because they strongly shape waste management activities. This section explains the economics of waste by highlighting the differences with the economics of regular goods. First, consider the following economic description of regular goods:

- *Supply and demand.* The supply of goods is constrained by the cost of extraction, production and manufacturing of materials and products. The demand for goods is constrained by the preferences of consumers and their budgets.

- *Prices.* Product prices are the result of the forces of supply and demand. The price acts as a signal for suppliers and consumers. When demand increases, the price goes up; when supply increases, the price goes down.
- *Substitution.* The substitutability of products allows consumers to opt for alternatives when they wish to. For example, a higher price for apples may shift demand towards other fruits that provide similar benefits.
- *Opportunity cost.* The opportunity cost represents the value of the most attractive foregone option. The opportunity cost is the difference in value between the chosen option and the option that the person would have liked best.

Waste is somewhat different in all four respects. First, the supply of waste is not constrained by extraction, production and manufacturing activities. Instead, waste supply largely depends on the behaviour of consumers and businesses, who discard materials and products when they become unwanted. Waste generation does not respond to a price signal unless the waste collector has differentiated charges by volume, weight or type of waste. Even with differentiated pricing, the price signal tends to be weak compared with primary products.

Second, unlike regular products, which have a positive value, waste tends to have a negative value, and the waste generator pays to get rid of it. For example, a landfill operator is paid to take waste. In economic terms, the sign of the price shows whether a material is a product or a waste. While discarded materials have a negative price, they can be treated for recovery, upon which the price may become positive, depending on the quality and the demand. When the price of the recovered waste (e.g., sorted office paper) is lower than the price of the virgin alternative (e.g., virgin wood), recovery becomes economically attractive.

Third, substitution is problematic because waste quality is highly variable; the composition and level of contamination are dependent on time and location. Waste takers, such as steel mills, cannot substitute between virgin metal and scrap steel at a constant rate; they need to regularly check the quality of the waste. Variability in quality, and the resulting price volatility, can obstruct investment in waste treatment and recovery because it makes it hard for investors to foresee the return on investment.

Fourth, the concept of opportunity cost matters a great deal to waste because it coincides with the description of the problem of waste in the introduction of this chapter. Waste was deemed a 'loss of natural resources'; this loss could be quantified by citing the opportunity cost of losing the materials. The opportunity cost equals the value of the best possible alternative use of the material. For

example, when recyclable waste is landfilled, the opportunity cost may be expressed as the value that would be gained through recycling instead.

Finally, there is an overarching difference between the economics of goods and the economics of waste. Whereas the goods market is relatively free because most businesses and consumers have an interest in high-quality products and services, the waste market is highly regulated to prevent waste generators from choosing the cheapest solution for their waste, which is dumping, with consequent harm to the environment. From the definition of 'waste' to the price of landfill, almost anything in waste management is regulated to prevent careless disposal and environmental pollution.

#### **BOX 2.4 IF ONLY... AN OPPORTUNITY COST PERSPECTIVE**

Food waste represents a significant economic cost and environmental burden in terms of waste collection, treatment and disposal. A major environmental consequence is the release of GHGs from food waste in landfills.

However, the bigger issue with food waste is the opportunity cost; uneaten food represents a missed opportunity to feed more people or, put another way, to use less land to feed the same number of people. Studies show that approximately one third of the food that leaves farms ends up uneaten, which implies an opportunity to reduce land usage by about one third, or increase the number of people who are fed by about half.

The opportunity cost of our diets is even larger; if we ate more plant-based foods instead of meat or dairy, we would greatly reduce the amount of agricultural land that is needed because plant-based foods do not require the inefficient conversion of feed into meat or dairy. For example, instead of using land to grow grass that is eaten by cows that supply meat and milk, we could use the land to grow crops for direct human consumption.

A study on the United States showed the inefficiency of meat and dairy production: just 31 per cent of the protein initially fed to chickens ends up in eggs and just 3 per cent of protein fed to cattle ends up in beef. If all US citizens shifted to a plant-based diet, the world could feed another 350 million people (also on a plant-based diet) using the same land area.

Source: Shepon et al. (2016); Shepon et al. (2018).

## 2.5.2 The cost of waste management

Waste collection and treatment for households and small businesses is typically the responsibility of local governments, who charge or tax residents and business owners and use the revenues to run or contract out waste management services. For example, a municipality may contract a company to collect waste or pay for the services of a privately owned waste incineration plant. For large businesses and industry, waste management is typically not a public service but a direct arrangement between the waste generator and the waste manager.

The main cost components of waste management are for collection and treatment. For MSW, the collection costs tend to dominate and depend on the combination of travel distances between collection points, waste quantities per point and the frequency of collection. These factors, in turn, are the consequence of population density, as well as the extent of source-separation, which may require more trucks and collection points. Collection costs consist of both investment costs (collection points, trucks, transfer stations) and variable costs (fuel, wages).

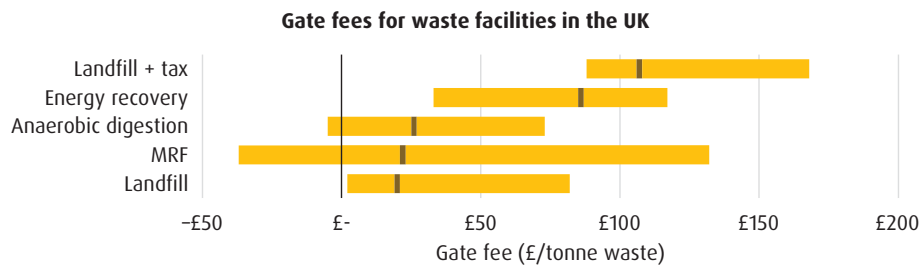

**Figure 2.6 Minimum, median and maximum gate fees for MSW in the UK.** Data taken from WRAP (2018).

The treatment costs typically consist of the gate fees charged by the operators of, among others, incinerators and landfills. Figure 2.6 shows the gate fees reported by local governments in the UK (i.e., the fees the local authorities pay to the operators). The figure illustrates that even within the same country, there are large differences between the lowest and highest reported fees, which may be partly explained by the age and efficiency of the facility and the composition of the waste that is supplied. The price differences can persist because it is often not profitable to transport waste to a cheaper but more distant facility.

According to Figure 2.6, the lowest reported gate fees for anaerobic digestion and MRFs are negative, which means that the operator will pay to receive waste. In this case, the operator apparently gains sufficient revenue from the sale of

treatment outputs to cover its costs. For anaerobic digestion, this could include the sale of electricity, heat and digestate. For an MRF, the sale of recyclables and refuse-derived fuel (RDF) can be a significant source of income. The actual costs of operating the facility will also depend on taxes and subsidies related to these outputs; for example, electricity from anaerobic digestion plants may receive a subsidy for renewable energy.

Any price comparison between the different options should be approached carefully. According to [Figure 2.6](#), landfill has both the lowest and highest average price, depending on whether the landfill tax is included in the price estimate (the tax is meant to reduce landfilling). Besides, not every waste can be practically or legally accepted at every facility. For example, metals cannot be digested or burnt, and the gate fee of anaerobic digestion or incineration is therefore irrelevant. The following chapters will occasionally reference economic aspects of technologies or practices, including economic policies in [Chapter 4](#) and the economics of circular use of materials in [Chapter 9](#).

## **2.6 SUMMARY**

Sustainability means meeting people's needs now and in the future by respecting the finite limits of the natural environment in which society and the economy are embedded. The natural environment consists of the lithosphere, hydrosphere, biosphere and atmosphere, and together these provide ecosystem services to humans – provisioning, regulating, cultural and supporting functions – besides, the natural environment has intrinsic and relational value. To protect these roles of the environment, limits to pollution have been identified, which may inform regulation.

Environmental impacts are those changes to the environment that negatively affect its health and functioning. The causal chain of environmental impacts can be understood using the DPSIR framework. Environmental impacts have an effect on human health, the natural environment or natural resources; key categories include climate change, ozone depletion, the quality of air, water and soils in relation to human and ecological health, as well as the availability of key resources including materials, land and water.

Waste has distinct social and economic characteristics that shape its generation and management. The physical and symbolic properties of waste reinforce patterns of distancing and inequality, with the burden of waste and waste management often falling onto poor and marginalised groups, both locally and globally.

The social impacts of waste and waste management projects include changes to people's way of life, culture, community, politics, environment, health and wellbeing, personal and property rights, and fears and aspirations.

Economically, waste is different from products or 'goods'; waste is a 'bad', which often has a negative price; its supply is detached from demand; it cannot fully substitute virgin resources; and underutilisation implies an opportunity cost. Waste collection costs are a function of travel distances, waste quantities and separate fractions, and collection frequencies. Waste treatment costs are reflected in the gate fees that are charged per tonne of waste accepted. The costs of waste collection and treatment vary widely between technologies, places and over time.

## **2.7 REVIEW**

- 1.** List the domains of sustainability and the four types of ecosystem services.
- 2.** Provide examples of the intrinsic and relational value of nature.
- 3.** List and explain at least ten of the main environmental impact categories.
- 4.** Apply the DPSIR framework to air pollution, assuming the driver is waste incineration.
- 5.** Identify influential social norms regarding waste in your social environment.
- 6.** Reflect on the social impacts an incineration plant could have on your neighbourhood.
- 7.** Explain the main economic differences between products and waste.
- 8.** List the main operational and investment costs of an MSW management system.

# 3

# ASSESSMENT METHODS

## LEARNING OBJECTIVES

After studying this chapter, you should be able to:

- explain the main purposes of conducting an impact assessment
- conduct a basic material flow analysis and reflect on the results
- conduct a basic lifecycle assessment and reflect on the results
- describe other types of assessment methods relevant to waste
- compare the various methods and reflect on their appropriate use



## 3.1 INTRODUCTION

The [previous chapter](#) introduced a great number of environmental, social and economic impacts of material use and waste management. This chapter explains the assessments used to establish when, where and how these impacts occur. There is no single assessment method that covers all the impacts – instead, the chapter will cover various methods, each of which has been developed for application to a selection of impacts. The methods will look somewhat familiar because they focus on the previously discussed impacts and, to a greater or lesser extent, apply the logic of the DPSIR framework. Some impacts will appear in more than one of the assessment methods.

This chapter describes the purposes, steps and limitations of two dominant techniques that focus on understanding resource flows and their impacts: material flow analysis (MFA) ([Section 3.2](#)) and lifecycle assessment (LCA) ([Section 3.3](#)). The relevant sections cover the main steps involved in both methods, providing insights into the origins of current knowledge – for example, when people state it is important to recycle, they (perhaps unknowingly) build on evidence from LCA studies. Moreover, the chapter helps you gain enough of an understanding to conduct a basic version of such an assessment yourself.

Various other methods exist for capturing the environmental, social or economic impacts of man-made products and systems, often covering multiple stages of the lifecycle from raw material extraction to waste management. These other methods will be discussed briefly in [Section 3.4](#), and include environmental impact assessment (EIA), social impact assessment (SIA), cost-benefit analysis (CBA) and environmentally extended input-output analysis (EEIO). The relevant sections will create an understanding of why these methods are applied and what the underlying principles are; you will not, however, learn how to apply these methods yourself.

## 3.2 MATERIAL FLOW ANALYSIS (MFA)

### 3.2.1 The purpose of MFA

Imagine you were asked to improve the waste management system of your city. Improvement, as discussed, probably means ensuring universal collection, moving up the waste hierarchy and lowering environmental impacts. To achieve this, you would need to know how it currently performs, how this is likely to develop into the future and which actions can make a substantial difference. In short, you would need to know how to conduct a material flow analysis. An MFA develops a model of the processes in a system, such as a product lifecycle or waste management system, and how they are connected; it also records the amounts of materials that flow between different parts of the system and accumulate within it. An MFA serves the following purposes:

- It finds inefficiencies in the waste management system and identifies conversion processes that can be improved, such as waste sorting or reprocessing.
- It anticipates the depletion and accumulation of materials, such as an excess of recyclable materials due to a lack of processing capacity.
- It designs efficient and compatible material flow systems with appropriate capacities for collection, treatment, recovery and disposal of waste.

On top of this, an MFA can help project and anticipate future emissions and impacts when it is extended with a description of the environmental pressures presented by the various elements of the material flow system. For example, you could calculate the GHG emissions associated with waste transport, treatment and disposal. Such an extended MFA straddles the line between MFA and LCA. [Section 3.3](#) will further discuss the assessment of environmental impacts in the context of LCA.

What exactly is MFA? According to Brunner and Rechberger (2016), who wrote a handbook on the subject, MFA is ‘a systematic assessment of the flows and stocks of materials within a system defined in space and time’. Such an assessment is based on the conservation of mass; for a closed system, mass cannot be destroyed or created, but must remain constant. In other words, any material that enters the system (an input) must either leave the system (an output) or stay there (a stock); material cannot simply disappear, though it may change its form.

$$\text{Input} - \text{Output} = \text{Stock change}$$

Equation 3.1

The mass balance principle is presented concisely in Equation 3.1. This simple but powerful principle helps in conducting an MFA because it implies that of inputs, outputs and stocks, you only need to know two to calculate the third. For example, knowing how much plastic enters an MRF and how much the stock of plastics in the MRF changed automatically tells how much must have left the facility. In practice, all three may be measured or estimated separately and then compared for validation; if the values do not add up, the analyst has to do further work to harmonise the material balance.

### BOX 3.1 EXAMPLES OF MFA STUDIES

Table 3.1 provides examples of three MFA studies. They differ in terms of the system, space, time, flows, processes and stocks that are described. They also have slightly different purposes. The first study intended to assess whether recycling metrics (Section 7.2.2) provide a fair representation of circularity. The results show that measuring recycling through collection rates leads to an overestimation of the amount of paper that is actually used again. The second study also aimed to develop better metrics. Based on the MFA, it suggests several metrics that capture the magnitude and circularity of the material system.

**Table 3.1 Three examples of MFA studies.**

	Van Ewijk, Stegemann and Ekins (2018)	Mayer et al. (2019)	Chakraborty et al. (2013)
<b>Purpose</b>	Mapping current flows and recycling potential	Assessing the circularity of the EU economy	Assessing mercury flows and pollution control
<b>System</b>	Paper lifecycle	Economy	Economy
<b>Space</b>	Global	European Union	India
<b>Time</b>	2012	2014	2001–20
<b>Flows</b>	E.g., wood, pulp, paper products, mill waste	E.g., imports, domestic extraction, emissions	E.g., emissions to air, soil and water
<b>Processes</b>	E.g., pulping, papermaking, use, waste treatment	E.g., energetic use, material use, addition to stock	E.g., agriculture, wastewater treatment, landfill
<b>Stocks</b>	Various in-use paper products, e.g., books	Buildings, infrastructure, other long-lived products	Products, landfills, ash-containing structures

The third study is called a dynamic MFA because it investigates how flows change over a time frame of several years. Dynamic MFAs are useful for characterising



material systems that change substantially within a given time period. For example, they may estimate future outflows of waste and pollutants based on material inputs and stock-building. In the cited study, the total stock of mercury in products in India was estimated to increase by around 60 per cent over two decades. This was calculated from estimates of inputs of mercury into the economy, the lifetimes of products that contain mercury and the outputs of mercury from the economy.

### 3.2.2 Key concepts

Assuming you agreed to conduct an MFA of the waste management system in your city, you now have to narrow down what exactly the analysis will cover. What does the ‘waste management system’ consist of? What kinds of materials and substances enter or leave the system? Should all of them be recorded in the analysis? Are these materials and substances converted into other materials and substances in processes such as treatment and recovery? And where should you draw the spatial and temporal border? In deciding these questions, the following concepts are essential:

- *System boundary*. The system boundary defines the system in space and time and dictates which materials, processes, flows and stocks are included in the analysis. Only processes inside the system boundary are considered. Flows that enter or exit the system are considered, as well as those that are fully inside the system. Stocks are included only when inside the system.
- *Materials*. Materials is an umbrella term for all physical substances, ranging from natural rocks such as metal ores to products such as smartphones. Materials can be in the gaseous, liquid or solid phase. When conducting an MFA, water and air are often excluded, but they should be considered when the water content of materials changes or when conversions take place, such as the conversion of oxygen to CO<sub>2</sub> and water during combustion.
- *Processes*. Processes carry out the transformation, transport or storage of materials. Transformation refers to changes in the characteristics of material flowing into a process, such as waste separation activities, leading to material outflows of a different composition. Transport occurs in between transformation processes. Storage occurs whenever materials are not moved within the time window of the analysis.
- *Flows*. Flows occur between the processes in a system. They are usually described in terms of the mass units of a material per unit of time. An example of a flow is ‘7.8 Mt of cement in the UK per year’, which described the amount of cement that was produced in the UK in the year 2015.

- *Stocks*. Stocks describe the mass units of materials that accumulate in storage in the defined time period. An example of a stock would be the total amount of cement in concrete buildings in the UK.
- *Transfer coefficients*. Transfer coefficients describe the partitioning of materials in a process. For example, when a mixed waste flow enters an MRF, it may be separated into a paper, metal, plastic and residual waste fraction. The transfer coefficient describes which fraction of the input is converted into one of these separate waste flows. The sum of transfer coefficients for a single process must be 1.
- *Product lifetimes*. The relation between stocks and flows is often mediated by how long products are used before they are discarded. For example, if buildings are used for 50 years on average, we know that the consumption of construction materials in 2020 is likely to equal the amount of demolition waste in 2070. Of course, not every building is used for the same number of years. This variety can be captured in a statistical distribution of product lifetimes.

All of the aforementioned elements, apart from the transfer coefficients and product lifetimes, are shown in the process diagram in [Figure 3.1](#). When conducting an MFA, the process diagram provides the start for your data collection process. This is an iterative process, because data collection efforts often reveal the need to adjust the process diagram. For example, it may turn out that the analyst overlooked a process or perhaps there is no data for certain flows, transfer coefficients or product lifetimes, which means the process diagram has to be changed or simplified.

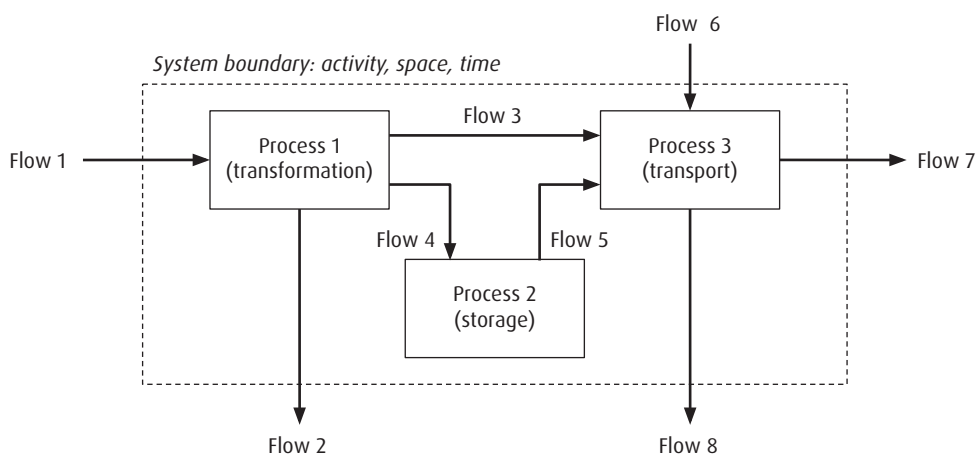

**Figure 3.1** Generic process diagram for MFA. Image: Authors' own.

### 3.2.3 Data collection and calculations

After drawing an initial process diagram of the waste management system, you can start looking for data to quantify the stocks and flows. Flow data for MFA is available from many different sources, depending on the chosen system. The measurement of waste generation data was already discussed in [Section 1.4.2](#). For a geographical area, as opposed to, for example, an industrial facility, the waste flow data is typically collected by governments, but not all this data may be publicly available. Further datasets may be available from waste generators, collectors, recyclers and processors.

Data is often inconsistent or incomplete. Missing data can be calculated in various ways. First, there is the mass-balance principle, but this only works if just one value is missing for a given part of the system. If you have historical data, you can calculate the stocks by aggregating additions to, and removals from, stock over time. If materials are converted, there are four key elements to consider: inputs, outputs, stock changes and transfer coefficients. The following three approaches can also help close the gaps in a material balance.

- *Stock dynamics*. As mentioned, changes in stocks follow from additions and removals in a certain time period. Alternatively, the patterns of stock-building can be inferred from a more fundamental understanding of the process, including the lifetime of products. For example, the number of cars that are scrapped can be inferred from car sales and the typical car lifetime. If cars are used for, on average, about 25 years, the volume of waste in a certain year equals the sales 25 years previously.
- *Stoichiometry*. When the relevant process is a chemical conversion, you can use stoichiometry to calculate the transfer coefficients. For example, the stoichiometric equation for chemical oxidation of cyanide shows that one molecule of hydrogen peroxide is required to destroy a molecule of dissolved cyanide. The mass flows of these substances can be calculated based on their molecular weights.
- *Proxies*. The perfect data may not be out there, but other data may describe something similar. The similarity may be spatial, temporal or in terms of technology. For example, you may be able to find data for a larger or smaller geography, for earlier or more recent years or for a technology resembling the one you are studying. The proxy data may need scaling or averaging; for example, you could take consumption data for the European Union and estimate consumption in Spain or at the global level based on population figures.

Constructing a material balance involves trade-offs between different data sources. While there will often be missing data that can only be estimated, sometimes there may be various ways to calculate the same flow, and the results may be different. In such cases, you will need to make a reasoned decision about what figure to choose. It could be one of the figures, or the average, or you could minimise these discrepancies for the whole balance at the same time (since all flows are interconnected). Unfortunately, differences in data sources are not the only sources of uncertainty, as the following section will explain.

### BOX 3.2 AN MFA OF COPROCESSING OF CONTAMINATED WASTE

Waste incineration plants use filters to clean combustion gases before they enter the atmosphere. This leads to a new waste product, air pollution control residue (APCR), which is a dust rich in toxic metals that is not accepted at a regular landfill. An alternative is to encapsulate the APCR in concrete structures, for example, in buildings, by using it in the production of cement ('coprocessing') used for concrete.

Unfortunately, the contaminants in APCR affect the cement production process and the quality of the resulting cement. To understand this better, a group of researchers, including the authors of this book, conducted a combined MFA of the material flows (e.g., cement) and the substances in the material flows (e.g., lead). The resulting material and substance balance shows how much of what material goes where, and how much of the different contaminants it contains.

The results suggest that the use of APCR in cement significantly raises the level of contaminants in the cement, as well as in the dust and air emissions from the cement-making process. Besides, the contaminants can lead to unacceptable operating conditions in the cement plant. In conclusion, only a limited amount of APCR should be coprocessed, while important questions remain regarding the fate of the contaminants upon future demolition of the concrete structure.

Source: Marchand, Van Ewijk and Stegemann (2019).

#### 3.2.4 Uncertainty and limitations

The sources of uncertainty in MFA can be categorised into two main types. First, *model uncertainty* is introduced when deciding on the system scope and boundary when drawing your process diagram. Did you include all the relevant facilities

and flows? Did you consider transport, where relevant? Did you appropriately include flows for inputs and outputs from the system due to trade with other geographies? The MFA does not need to cover every detail but should include everything that is essential to the purpose of your analysis.

Second, *data uncertainty* is the type of uncertainty that was alluded to in the [previous section](#); when data sources contradict each other, at most one of them is correct, and likely none of them are. When there is only one data source available, it is not possible to validate the data through comparison, but you can still critically assess the quality of the data by studying why, how, when and where the data was generated. In the case of data that is missing entirely, assumptions may be used to fill the gap, but the validity of these assumptions must be well justified. Data uncertainty applies to both stocks and flows, transfer coefficients and other parameters, such as those for product lifetimes.

[Table 3.2](#) gives an overview of indicators of data quality, including a definition of the indicator and a description of what is typically considered to imply low or high uncertainty. The table can be used to provide confidence ratings for material flow data, which in turn support an evaluation of the uncertainty regarding the conclusions that can be drawn from the material balances. For example, a material balance may show that recycling levels are low, but this conclusion only stands firmly if the underlying data is considered to be of high quality.

**Table 3.2 An assessment of data quality.** Adapted from Laner et al. (2016) and Weidema and Wesnæs (1996).

	High quality	Low quality
Reliability	The data generation methodology is well-documented, consistent and peer-reviewed.	There is no documentation and the data generation methodology is not known at all.
Completeness	The value includes all the relevant processes and flows in the system.	The data excludes important processes and flows in the system.
Temporal correlation	The values are representative of the time for which the MFA is conducted.	There is a large gap, e.g., of 10 years, between the time the value is for and the MFA.
Geographical correlation	The data is representative of the studied space, e.g., region, city or country.	The data is representative of a different space with very different properties.
Further technological correlation	The data is representative of the chosen technology, facility, product etc.	The data is representative for a totally different technology, facility, product etc.



Even a sound material balance based on a good process diagram and data with low uncertainty has clear limitations. The foremost limitation of MFA is that the assessment does not provide a direct description of the impact of the system or its individual components; it simply shows material stocks and flows. The impact depends on the type of material, production and manufacturing methods, user practices and waste collection, treatment, recovery and disposal options. For example, an MFA cannot tell whether the recycling of material A has more benefits than the recycling of material B; it can only tell which material is recycled more.

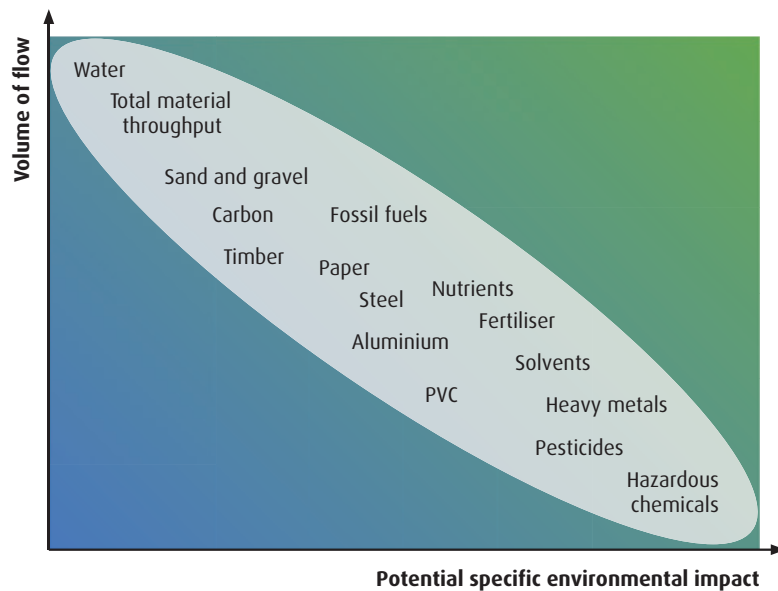

**Figure 3.2 Impacts and quantities of materials.** Adapted from OECD (2008).

At the same time, some materials are clearly more harmful than others, which helps with the interpretation of MFA results. Figure 3.2 shows that most attention should be paid to materials that are either used abundantly or that have particularly high impacts. More harmful materials include pesticides, chemicals and solvents. Less harmful materials include timber, sand and gravel. The latter materials are not toxic or hazardous, unless contaminated. However, an abundance of these materials can still cause problems; for example, a large volume of timber may imply widespread deforestation and loss of biodiversity.

### EXERCISE 3.1 A COMMON STOCK-AND-FLOW PROBLEM

Few people call themselves material flow analysts, but even fewer people have never engaged in some form of MFA. Think of a fridge, which people like to be well stocked. To keep the stock at a stable level, stock losses (the food you eat) must be compensated for with stock additions (new purchases).

Consider the following situation, in which Martha, Stuart and John share a fridge. Can you conduct an MFA to calculate how much edible food is left after four weeks?

- 1) Every week, Martha buys 3 kg of groceries, Stuart buys 1 kg and John buys 2 kg.
- 2) Every week, Stuart eats 2 kg of food, Martha eats 1 kg and John eats 2 kg.
- 3) Every week, 10 per cent of the leftover food in the fridge goes bad.

What is your system boundary and what are the key processes, flows and stocks in your system? Compare your answer with someone else. If there is a discrepancy, you may have to redo the calculation using a spreadsheet to avoid mistakes.

How representative is this problem of a real-world situation? How could you use product lifetimes to estimate the stock dynamics more reliably? What could Martha, Stuart and John do to lower the fraction of food going bad?

## 3.3 LIFECYCLE ASSESSMENT (LCA)

### 3.3.1 The purpose of LCA

LCA is a method to identify environmental impacts associated with all lifecycle stages of a product or service. It goes beyond the material balance that can be created with MFA by not only mapping relevant material flows over the whole lifecycle – which is called the lifecycle inventory (LCI) – but also conducting an impact assessment – which is called the lifecycle impact assessment (LCIA) – to gauge the environmental significance of the flows. LCA methodology is mainly used to compare purchasing choices or product designs based on their environmental impacts. More broadly, an LCA can serve the following purposes:

- *Product improvement.* Identifying opportunities to improve the environmental performance of products at various points in their lifecycle.
- *Decision-making.* Informing planning, priority-setting, process design and procurement in industry, government and non-government organisations.

- *Indicator selection.* Identifying relevant indicators of environmental performance and ways of measuring and calculating these.
- *Marketing.* Supporting eco-labelling schemes, environmental claims about products or environmental product declarations (EPD).

For all these purposes, a lifecycle perspective is essential because it avoids burden-shifting. Burden-shifting describes the inadvertent increase of one impact when trying to reduce another, whether between lifecycle stages or between types of environmental impacts. For example, in sourcing materials from mining operations with lower impacts, the composition of the product may be affected such that the production emissions, or those during the use of the product, are drastically increased. Similarly, by reducing the carbon emissions of a product to reduce climate change, the amount of harmful chemicals may be increased, worsening other forms of pollution.

LCA starts by establishing a fair basis for comparison between product designs, manufacturing processes, use options or waste management strategies. This basis for comparison is called the functional unit and focuses on what the product can do. An example of a functional unit is ‘transporting 1 person over 1 kilometre in 2023 in Germany’. By starting with a functional unit, LCA allows comparison of a potentially infinite number of ways to deliver this functionality and compares them fairly because the impact is scaled to the same unit. For example, a car and a bike should be compared based on emissions per person per kilometre, and not over their total lifetime, because cars can transport more people over more kilometres.

The functional unit has another advantage. The calculated impact is directly linked to the purpose served by the options under analysis, and to the people that enjoy the functionality. For example, the lifecycle emissions of a car are linked to the functionality enjoyed by the car driver and the passengers. The alternative is to allocate emissions to, for example, the producers of the car or the country where the production took place, which hardly makes sense because the car ultimately serves the driver and the passengers. A slightly different approach may be taken in the case of LCA of waste management, which is explained in [Box 3.3](#).

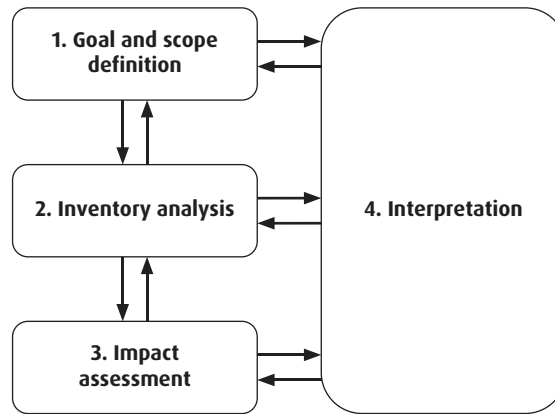

**Figure 3.3 The main steps in LCA.** Adapted from ISO (2006).

Figure 3.3 shows that LCA consists of four main steps: goal and scope definition, inventory analysis, impact assessment and interpretation of the results. Analysts often go back and forth between these steps. For example, it may turn out that certain data is not available for the inventory analysis, in which case the goal and scope definition may have to be adjusted; the arrows in the diagram therefore go both ways. The next few sections discuss each of the four steps and the boxes provide examples of the analytical steps and challenges for an example LCA study, which investigates whether adherence to the priorities of the waste hierarchy necessarily leads to the least negative environmental impacts.

### BOX 3.3 THE 'ZERO-BURDEN' APPROACH IN WASTE LCA

Most LCA studies define a functional unit in relation to the product user. However, for analysing waste management, LCA studies often take a unit of waste generation as the starting point. A unit of (mixed) waste generated does not fulfil a function, but it is a sensible functional unit for comparing waste management options. When comparing different waste treatment options, but without any associated differences in production methods or material choices, the early lifecycle stages



would contribute the same impacts in each scenario, and may thus be cancelled out. This is called the ‘zero-burden’ approach since the environmental burden of the waste in the earlier stages of the lifecycle (when the material was not yet waste) is considered zero. The approach is valid for a comparison of waste treatment options but cannot show the potential benefits of waste prevention.

### 3.3.2 Goal and scope

LCA starts with defining the goal and scope of the study. The International Organization for Standardization (ISO) has developed a standard for LCA (ISO 2006), which states that goal definition involves the formulation of:

- the intended application;
- the reasons for carrying out the study;
- the intended audience;
- the level of publicity.

The scope definition consists of defining the product system, the functional unit, the system boundary and the allocation rules. The ISO standard describes the product system as the ‘collection of unit processes with elementary (raw materials and energy) and product (transformed materials and energy) flows, performing one or more defined functions, and which models the life cycle of a product’. The functional unit is the ‘quantified performance of a product system for use as a reference unit’; an example of a functional unit was already provided in the [previous section](#) (‘transporting 1 person over 1 kilometre’).

Similar to MFA ([Section 3.2.2](#)), the system boundary is the ‘set of criteria specifying which unit processes are part of a product system’. It is the boundary that delineates the product system that fulfils the functional unit. [Figure 3.4](#) provides an example depiction of a product system, including the (dotted) system boundary. The system boundary excludes certain processes from the analysis (‘cut-off’ in LCA terminology) – this exclusion should be based on a reasonable assessment of their importance; for example, for an analysis of newspaper production, you might exclude the production of inks, but include the energy requirements for printing.

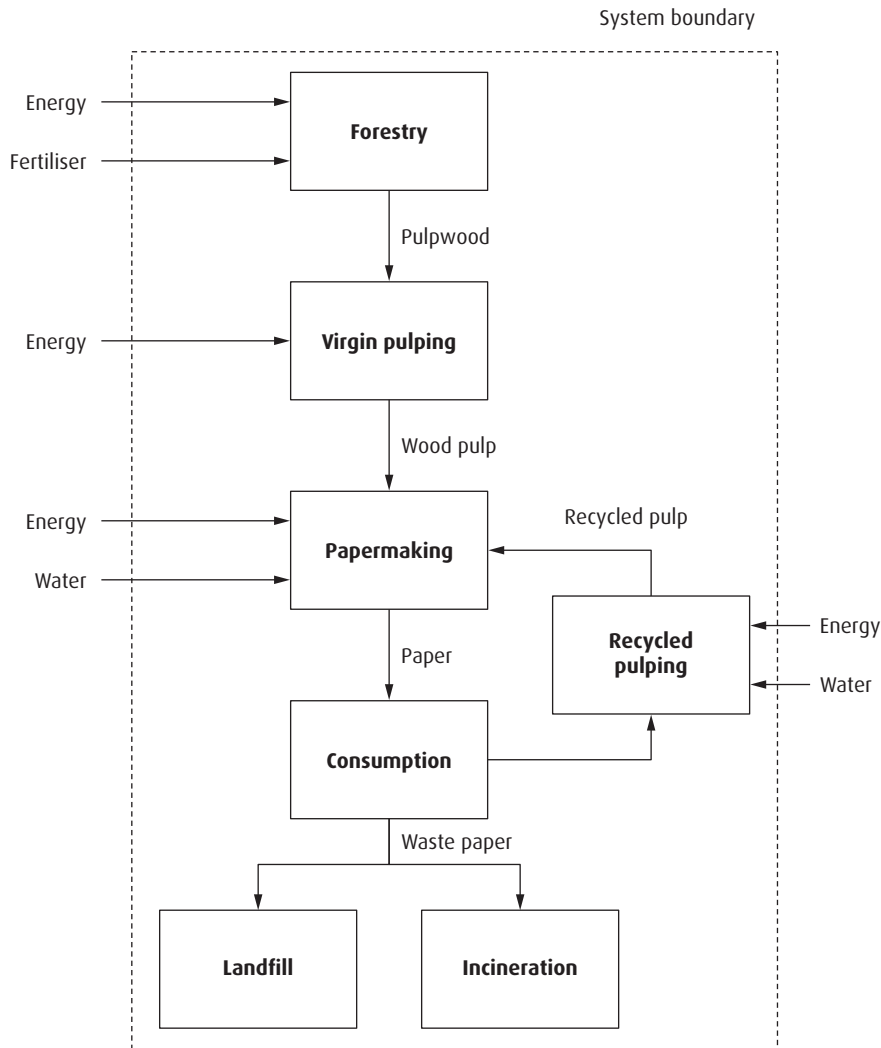

**Figure 3.4 Product system with system boundary for the paper lifecycle. Only inputs to the system are shown, not outputs from it.** Adapted from Van Ewijk, Stegemann and Ekins (2018).

In defining the goal and scope of the LCA, you can already decide on how to approach the next steps in the LCA: the choice of impact assessment method and the means of interpretation. Impact assessment and interpretation are discussed in [Sections 3.3.4](#) and [3.3.5](#). Deciding on these matters upfront is part of the iterative approach to LCA; since all steps in the analysis are interrelated, the analyst has to think ahead, as well as having to go back at times. [Boxes 3.4](#) to [3.7](#) explain each step in LCA through the example of an LCA regarding the waste hierarchy for paper.

### BOX 3.4 LCA OF THE WASTE HIERARCHY: GOAL AND SCOPE

This box, and the next few, discuss an LCA that examines whether the waste hierarchy, which is widely used but not validated for every material stream and context, leads to the least negative environmental impacts over the whole paper lifecycle. The study was for publication in an academic journal, open to subscribers, and was published in 2007 (Schmidt et al. 2007). The scope included the extraction, production, manufacturing, use and waste management of paper discarded in Denmark. The functional unit was formulated as ‘Denmark’s consumption (waste management) of paper in 1999, totalling 1.2 million tons’. A strongly simplified version of the product system is shown in Figure 3.4. Although the analysis focuses on waste management, the LCA did not take a ‘zero-burden approach’ (Box 3.3) because recycling of wastepaper affects upstream paper production activities.

#### 3.3.3 Inventory analysis

Inventory analysis creates a lifecycle inventory (LCI) of all environmentally relevant flows associated with the product system. The process is very similar to conducting an MFA. Conveniently, various databases have been developed that quantify the inputs and outputs of many processes. For example, a database may have figures for the material and energy requirements of the unit process ‘pulping a kilogram of wood’. This helps create an overview of all the inputs and outputs in paper production and consumption, provided the process diagram includes this unit process in the product system.



**Figure 3.5 A multifunctional process with two inputs and two outputs.**

Image: Authors’ own.

A challenging part of the inventory analysis is the allocation of flows for multifunctional processes, which are processes that generate more than one useful product. For example, Figure 3.5 shows a more elaborate description of pulpwood production than in Figure 3.4, considering that a forest may be used not just for pulpwood, but also for timber, which may be used in construction

or furniture-making. The question is: how much of the inputs (energy, fertiliser) should be allocated to the pulpwood, given that the process also generates timber?

- If you allocate all inputs to pulp, you overestimate the environmental impacts of paper.
- If you allocate inputs based on the mass fractions of pulpwood and timber, you ignore that timber is more valuable, and an important economic driver for forestry.

There are various ways of approaching this problem. Among them are three ways to avoid having to make an allocation altogether, but this will require the inclusion of additional data and processes. The fourth option is to find additional physical or economic data about the process to make an informed allocation decision. The options are explained below.

- *Subdivision.* Subdividing the process ‘forestry’ into separate processes such as planting, fertilising, thinning, cutting and transport can avoid allocation by isolating processing steps that are more relevant to one output than the other. For example, some cutting or transport may exclusively serve the extraction of pulpwood. However, planting and fertilising cannot be logically subdivided – it serves the production of both timber and pulpwood.
- *System expansion.* Expanding the functional unit and product system to also include the use of timber avoids having to do allocation; in the expanded analysis, the impacts and functionality of timber production are fully accounted for. However, system expansion requires additional data regarding the inputs and outputs of the additional processes, and only shows the combined impact of paper and timber.
- *Subtraction.* This variant on system expansion models the LCI for the co-product but, rather than including it in the original product system, subtracts it. For example, by modelling an alternative product system that produces only timber, you obtain the LCI for timber production, which you then subtract from the LCI for co-production of pulpwood and timber. This option will show the unique impact of paper, but involves extra work.
- *Allocation.* If the above options are not feasible, you can allocate flows based on the underlying physics or economics of the process. If, by mass, three-quarters of the wood is used for timber, you may choose to allocate three-quarters of energy and fertiliser to timber. Economically, however, timber sales may supply 90 per cent of the forestry revenue. In this case, an allocation based on the revenue gained from both outputs may thus be more representative.



### BOX 3.5 LCA OF THE WASTE HIERARCHY: ALLOCATION ISSUES

*Example continued from Box 3.4.*

In the study, it was assumed that the forest is used for pulpwood only, and the allocation issue described in the main text therefore does not apply. However, other allocation issues arise when comparing various levels of waste incineration and recycling.

- Incineration with energy recovery of paper waste supplies electricity and heat to the grid, which is a benefit not accounted for.
- Recycling of wastepaper reduces the demand for pulpwood, which can consequently be put to other uses, but this goes unaccounted for.

To address both issues, the authors opted for system expansion by modelling the provision of electricity and heat in power plants. In the expanded system, energy recovery from waste implies a reduction in outputs from electricity and heat provision. Moreover, since the electricity and heat were assumed to be generated with fossil fuels, and incineration of biomass was assumed to be carbon-neutral, the scenarios with increased pulpwood or wastepaper incineration led to lower overall emissions of the product system for paper, electricity and heat.

#### 3.3.4 Impact assessment

The lifecycle impact assessment (LCIA) is the step that most clearly differentiates LCA from MFA. It first consists of classification, which means the assignment of material flows in the LCI to specific impact categories (Figure 3.6; for a detailed description of the impact categories, see Table 2.1). For example, flows of greenhouse gases such as CO<sub>2</sub> and CH<sub>4</sub> should be allocated to the impact category ‘global warming’. Because CO<sub>2</sub> and CH<sub>4</sub> have different warming effects (CH<sub>4</sub> is a stronger but more short-lived greenhouse gas), they cannot be simply added up; characterisation is needed to express all contributions to a specific impact category in a single unit, such as CO<sub>2</sub>eq for global warming.

The impact categories are subsequently allocated to 'areas of protection'. The logic for this is very similar to the DPSIR approach; however, the terminology is somewhat different:

- *Mid-point* indicators refer to the characterised quantities of environmental flows. For example, the emissions in CO<sub>2</sub>eq serve as the mid-point indicators for the impact category 'global warming'.
- *End-point* indicators refer to the impacts of the flows on the three areas of protection: human health, natural environment and natural resources. For example, global warming affects where diseases like malaria can thrive, which is relevant to human health.

Various indicators are used to express the amount of damage to the three areas of protection. Below is a list of example indicators. Some of these indicators may appear very abstract or of limited meaning; can you think of other ways to express damage to the three areas of protection?

- *Human health*. The damage to human health can be expressed, among others, in 'disability-adjusted loss of life years', which represents a reduction in the years of life and the quality of life as a result of environmental impacts.
- *Natural environment*. The damage to the natural environment can be expressed in terms of species loss per year multiplied by the number of years. The natural environment, in this case, is considered only in terms of the number of species.
- *Natural resources*. The damage to natural resources includes greater resource scarcity, which can be expressed in terms of the increased cost of further extraction (assuming the cheapest resources were extracted first).

There is high uncertainty regarding the parameters for translating mid-point indicators to end-point indicators. Generally, mid-point indicators feature less uncertainty, but end-point indicators provide a more direct description of the significance of the impact because they directly relate to those things we are trying to preserve: human health, ecosystems and resources.

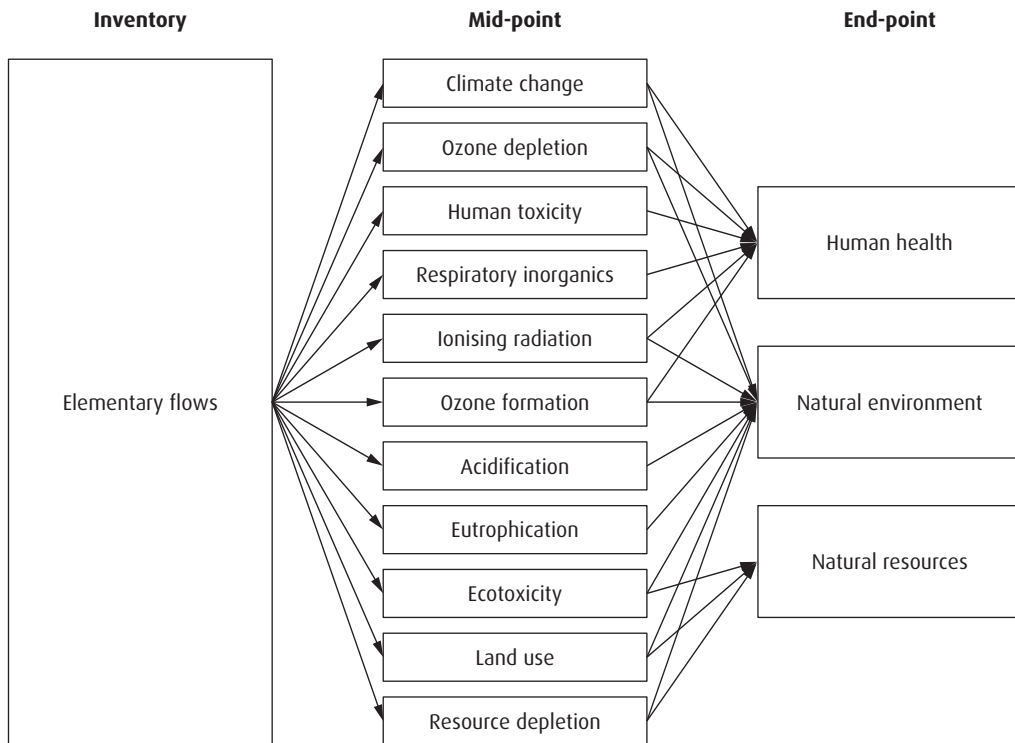

**Figure 3.6 The LCI, mid-points and end-points.** Adapted from JRC/IES (2010).

The inclusion of various impact categories in a single LCA introduces a major challenge: a decision to reduce one impact may increase another, so what should be done in this case? The answer can potentially be found through normalisation: the division of each impact score by a reference value unique to that impact. The reference values could be the average annual per-person score for the relevant impact category. When the estimated impact is relatively large compared to its reference value, this impact may be considered more important.

Weighting of normalised impact scores can enable a direct comparison, or even the creation of a single environmental score to be compared against the single score of another option. However, weighting should generally be avoided because there is hardly a scientific basis for deciding on the weights. As a consequence, comparative LCA studies cannot always show a clear winner. However, when they do, very often they provide valuable insights into areas of improvement for all of the options included in the comparison.

## BOX 3.6 LCA OF THE WASTE HIERARCHY: IMPACT ASSESSMENT

*Example continued from Box 3.5.*

Figure 3.7 shows the characterised results for five impact categories and per lifecycle stage. The results are plotted on a percentage scale with the total equalling 100 per cent. There are various negative figures; these are for emissions avoided in electricity provision due to the incineration of wood instead of fossil fuels. For all impact categories except global warming, production is the lifecycle stage with the highest impacts. However, the relative significance of the impact categories cannot be established until the scores have been normalised.

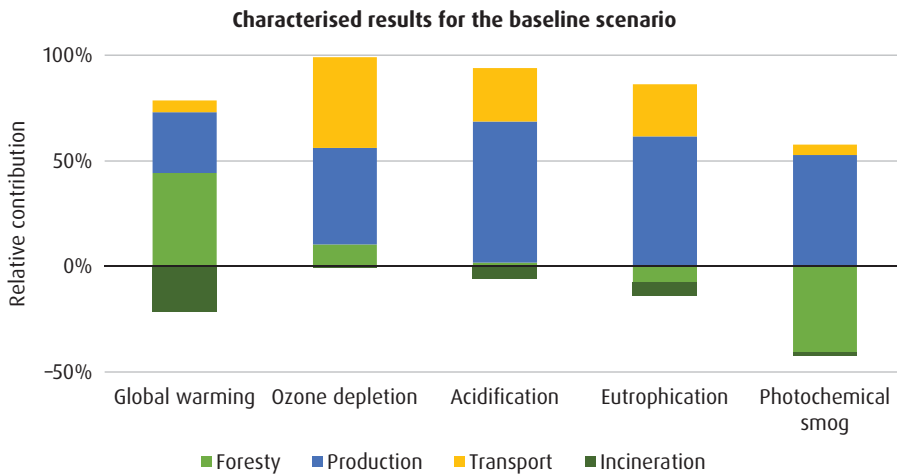
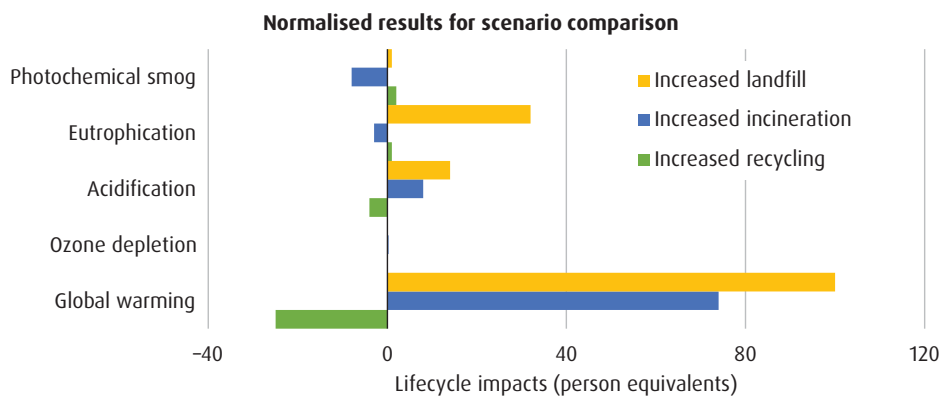

**Figure 3.7 Characterised LCIA results as a percentage of total absolute impacts per impact category.** Data from Schmidt et al. (2007).

Figure 3.8 shows the normalised impact scores for the three scenarios. The values are expressed in person equivalents (PE); each impact was divided by the average per-person impact. The figure reveals that global warming, acidification and eutrophication represent the most urgent environmental impacts. The scenario comparison also shows that the lowest total impacts in PE are achieved through



increased recycling, despite increased incineration performing best for some of the impact categories before normalisation.



**Figure 3.8 Normalised scores for three scenarios.** Data from Schmidt et al. (2007).

### 3.3.5 Interpretation

Interpretation is the fourth and final step in LCA and consists of identification of the significant environmental flows and impacts based on the LCI and LCIA. The interpretation should consider completeness of the analysis, sensitivity of the results to assumptions and data inputs and consistency of the modelling. The interpretation leads to the formulation of conclusions about what has been learned, what should be done, and what limitations should be considered. In short, the interpretation is where the questions that led to the LCA are answered, such as: how should the product be designed? What policy has the lowest environmental impacts? What waste management options are the most environmentally friendly?

Sensitivity analysis is required to show how uncertainty affects the results. As is the case for MFA, LCA is affected by model and data uncertainty (Section 3.2.4). The model uncertainty stems from the assumptions and decisions regarding the system boundary, product system, functional unit, classification rules and characterisation factors. The data uncertainty relates to the LCI. The potential for biased data to affect the results is even greater than with MFA due to the larger amount of data involved; the impact assessment adds a layer of uncertainty on top of the uncertainty in the LCI. This is another reason why normalisation and weighting of different impacts can be unwise – there is simply too much accumulated uncertainty.

Generalisation of the results – assessing to what extent the findings hold true outside of the specific context of the analysis – can be challenging; the analyst has

to deal with spatial variation of data (where?), temporal variation (when?) and variation between objects (which industry, facility, process, material or product?). For example, an analysis of the impacts of recycling at a steel plant in Detroit, Michigan may lead to insights that may or may not be valid for the recycling of materials other than steel, other steel plants inside of the United States, other steel plants outside of the United States or future steel recycling in the very same plant. To say whether the conclusions can be generalised, the analyst needs to have some sense of what influenced the findings – which follows from the sensitivity analysis – and whether these factors are significantly different between the various objects, time periods and places.

### BOX 3.7 LCA OF THE WASTE HIERARCHY: INTERPRETATION

*Example continued from Box 3.6.*

The study finds that the waste hierarchy is a sound principle for paper waste management, since recycling tends to yield the lowest overall impacts after normalisation. This conclusion holds when not accounting for the alternative use of wood, which is important to know, because the alternative use of wood has high uncertainty. Another major source of uncertainty is the fuel mix of the electricity and heat provision; a high-polluting fuel mix implies that an increase in electricity from pulpwood or wastepaper brings greater relative benefits. The study shows that different assumptions for the fuel mix lead to different results, but the priorities remain aligned with the waste hierarchy. The results cannot be generalised to materials because they may have different impacts when recycled, incinerated (if possible at all) or landfilled. The waste hierarchy is useful but needs investigation for uncertain cases; it cannot be assumed to be always valid.

### EXERCISE 3.2 UNDERSTANDING AN LCA STUDY

In the preceding sections, we looked at the main steps in LCA, using the example of a study on the waste hierarchy for paper. Look online for the following LCA study, which is available with open access: Liikanen, M., Havukainen, J., Viana, E. & Horttanainen, M. (2018), 'Steps Towards More Environmentally Sustainable



Municipal Solid Waste Management: A Life Cycle Assessment Study of São Paulo, Brazil', *Journal of Cleaner Production* 196: 150–162.

Read the study and try to answer the following questions.

- 1) What is the purpose of the study? What is the functional unit?
- 2) What are the goals and scope of the study? Which lifecycle stages are included? Does the study take a 'zero-burden' approach?
- 3) How is the LCI created?
- 4) Do you recognise any discussion of allocation issues? How are they addressed? Focus on energy recovery from waste incineration.
- 5) What is the impact assessment method? Which impact categories are covered? Does the study focus on mid-points or end-points?
- 6) How are the results interpreted? What are the recommendations? What are the major uncertainties? What should future research focus on?

If you can find a study that is more relevant to where you live, read it too and answer the above questions again. What are the recommendations for waste management in your country or city?

### 3.3.6 Bias and independence

The concerns regarding uncertainty and limitations of LCA resemble those for MFA (Section 3.2.4). However, the concerns tend to be more urgent for LCA, for at least two reasons. First, LCA is more often used to decide between options, and many users of LCA evidence interpret the results as definitive proof of the superiority of one option over the other, especially if it fits their prior beliefs or commercial interests. This confronts the analyst with the challenging obligation of presenting the results in a transparent and unbiased manner, to justify confidence in the conclusions.

Second, LCA requires more assumptions and more data than an MFA of the same subject. An LCA that shows one product to be superior to another may conclude the opposite after introducing minor changes to, for example, the functional unit, allocation choices, impact assessment methods or scenario design. Often, this is not apparent to the user of LCA results. By virtue of their absence, it is particularly hard to note exclusions from an LCA, such as an overly narrow scope, but they can greatly affect the outcome.

There are several measures that can prevent bias in LCA. First, adherence to standardised methodologies and widely available databases can reduce the variation in assumptions between studies and clarify how the main assumptions

were made. Second, sensitivity analysis should be properly used to test the impact of data choices and modelling assumptions on the results. Third, the LCA should be conducted and reviewed by independent experts, which can be difficult to ensure when the analysis is paid for by stakeholders with an interest in the outcomes, such as the manufacturer of the product.

**Box 3.8** illustrates the challenges of bias and independence for a comparison of hand-drying options, which even prompted a court case.

### **BOX 3.8 CONTESTED EVIDENCE: HOW TO DRY YOUR HANDS**

In the presence of vested interests, lifecycle evidence can become hotly contested. In 2011, a team of researchers at the Material Systems Laboratory (MSL) at the Massachusetts Institute of Technology (MIT) conducted a comparative LCA of hand-drying systems, commissioned by Dyson. They compared various hand dryers, cotton roll towels and paper towels based on a functional unit defined as 'a single pair of dry hands'. The results suggested that a Dyson model outcompeted all other options across seven environmental impact categories.

Dyson's main competitor, Excel Dryer, whose XLERATOR model was included in the study, found the study wanting. It noticed that drying time had a great influence on the results (the authors provide an extensive sensitivity analysis of many parameters including drying time). When Dyson used the study results in advertising, Excel Dryer sued with the following claim: 'In order to skew the results of the MSL Study in its favor, Dyson intentionally provide MSL with false data concerning the XLERATOR's dry time.'

Excel Dryer also pushed for a standardised approach to conducting LCAs of hand dryers. Together with other manufacturers, it developed product category rules (PCR) for hand dryers under the ISO standard 14025 for environmental labels and declarations. The PCR informs an LCA in the context of an environmental product declaration (EPD), which is a standardised approach for transparent communication of the lifecycle environmental impacts of products. The PCR was reviewed by experts (including one of the authors of the MSL study) and commented on by relevant organisations including Dyson and the US EPA.

The PCR prescribe a functional unit of 100,000 hand dryings, with dryness defined by a limit of 0.25 grams residual water. The residual moisture is measured by test-drying hands, then wiping off the remaining moisture with a paper towel and subsequently establishing the weight increase of the paper towel due to the absorbed moisture. Under this procedure, the drying time for the XLERATOR was found to be 7–8 seconds, whereas the MSL study assumed 20 seconds.





The MSL study, as well as a previous study commissioned by Excel Dryer, consistently found that hand dryers are superior to paper towels (the Excel Dryer brand slogan confidently states that it is ‘time to throw in the towel’). The paper towel manufacturing industry thinks about this differently. When confronted with the MSL study, Kimberly-Clark, a major paper producer, argued the following in a news article.

*Our opinion, as well as that of LCA experts and standards, is that studies such as this one (comparative LCA studies) are meant to examine products or services that provide comparable performance and function. That is, they should compare apples to apples. In academic/LCA circles, this is referred to as a ‘functional unit.’ In this case, the primary function of air dryers and hand towels differs: While both products dry hands, a critical function of the hand towel is to promote hand hygiene by reducing bacteria, thereby providing healthier environments.*

This critique, like the one by Excel Dryer about drying times, goes back to the functional unit. It suggests that the functional unit should not only cover the number of dry hands and their dryness, but also hygiene. As of yet, a standard that incorporates all three aspects in the functional unit has not been developed. Still, the definition of the functional unit is one of the first steps in conducting an LCA; even if everybody agreed over the functional unit, there would be much more to quarrel over.

Source: Dettling and Margni (2009); UL Environment (2016); *Excel Dryer, Inc. v. Dyson, Inc.*, (2014); United States District Court District of Massachusetts (2012, 2014); Excel Dryer, n.d.; Guevarra (2011).

## 3.4 OTHER ASSESSMENT METHODS

### 3.4.1 Overview of methods

MFA and LCA are key methodologies for understanding waste and resource management from a system perspective. Various other assessment methodologies can highlight the social, economic or environmental impacts of waste and resource management based on a different scope and system boundary. These methods differ in the steps that need to be taken and the data that is required, though there are also many overlaps with MFA and LCA. The next few sections will cover four methods for environmental, social and economic impact assessment.

- Environmental impact assessment (EIA) focuses on environmental impacts, just like LCA, but for a plan, project or policy, usually without consideration of the lifecycle.

- Social impact assessment (SIA) is similar to environmental impact assessment, but with a focus on social impacts and stakeholder participation.
- Cost-benefit analysis (CBA) focuses on a plan, project or policy, just like EIA and SIA, but expresses the economic, environmental and social impacts in monetary units.
- Environmental extended input-output (EEIO) analysis is related to LCA, but derives environmental flows from monetary exchanges between economic sectors.

Below, we describe these four methods only briefly. Many of the concerns and limitations raised for MFA and LCA (Sections 3.2.4 and 3.3.6) are also relevant to these other methods, including regarding data reliability, bias and independence. Among the assessment methods not further discussed in this book are lifecycle costing (LCC) and social LCA (SLCA). These two methods combine elements of CBA, SIA and LCA.

### 3.4.2 Environmental impact assessment

Environmental impact assessment (EIA) is an assessment of the environmental consequences of a plan, policy or project and is often required by law. It has a longer history than LCA, tends to be more qualitative and does not focus on products. Types of projects that require an EIA include mines and quarries, waste facilities, factories, roads, power plants and landfills. The purpose of the EIA is to make sure that planning decisions are made in full awareness of the potential environmental impacts and that these are considered in the execution of the project.

There is no universal methodology for EIA but it generally starts with *screening* of options to assess whether they are likely to have significant impacts. When it is decided that an EIA is required, the relevant issues to be included are decided in the *scoping* stage. The *baseline* is the description of the current status of the environment; the potential changes to the baseline are the subject of the *impact prediction*. The significance of the impacts is assessed during the *impact evaluation*, upon which the *mitigation options* for avoiding or reducing the impacts are studied.

The results are drawn up in an *EIA report*, which is supplied to the authorities and may be used for consultation. The report and the description of the mitigation options play an important role in the decision-making regarding the project and the subsequent *monitoring* of the results. Depending on their feasibility, some

or all of the mitigation measures may be required to reduce the environmental impacts from the project. The considered impacts often overlap with social and economic impacts and may include, for example, employment effects and social inclusion.

### BOX 3.9 AN EIA FOR THE DILLA CITY SANITARY LANDFILL

When Dilla City in Ethiopia planned a sanitary landfill, an EIA had to be conducted because of government and investor requirements. The EIA report describes the environmental and socioeconomic baseline conditions of the project, including the local geography, infrastructure connections, surrounding natural and built environment and local weather patterns.

The EIA report lists the potential positive and negative consequences of construction, operation and closure of the project. These include landfill gas generation and odours from decomposition; soil erosion during construction and operation; surface and groundwater contamination; noise, pests and dust, and health hazards; and loss of income due to quarry closure.

To deal with these issues, the report recommends various mitigation measures. For example, to avoid water contamination, the landfill needs a liner to minimise leakage to groundwater, and any contaminated water should be captured in a pond. Erosion can be minimised by, among others, choosing a landfill design with shallow slopes, which reduces runoff velocity.

The report also recommends strict adherence to the waste hierarchy. However, in 2018, a team of researchers from Haramaya University took samples from the landfill and found substantial fractions of potentially recyclable and recoverable materials, showing that good landfill design, construction and operation are only part of the puzzle of good waste management.

Source: Kebede, Mekonnen and Manikandan (2018); Zenas Engineering PLC (2010).

### 3.4.3 Social impact assessment

Social impact assessment (SEA) is an assessment of the social impacts and change processes caused by a plan, policy or project. As for EIA, the procedure for SIA is not universally agreed, but it resembles the steps of EIA. The guidance by the International Association for Impact Assessment (IAIA) suggests four main steps for analysing a project, which focus on understanding the initial situation,

assessing potential impacts, devising mitigation strategies and monitoring the results. A major difference with EIA is the emphasis on the early inclusion and participation of stakeholders.

In the first step, an understanding of the initial situation is gained by researching the project, clarifying the responsibilities of everyone involved, identifying the area of influence of the project and gaining an understanding of the community. Once this has been done, the analyst informs the relevant communities about the details of the project and the SIA. To include them, the analyst prepares the means for stakeholder participation and deliberation. A baseline is created from key social information and an assessment is made of potential social and human rights issues.

In the second step, the analyst moves to prediction, analysis and evaluation of the likely impact pathways, and assessment of options and alternatives. The assessment covers all the impacts listed in [Section 2.4](#). The third step involves the development and implementation of strategies to reduce impacts, enhance benefits and help communities deal with change. The following actions may be taken, in order of preference, with examples for a project involving the construction of an incinerator.

- *Avoid* the impacts altogether by changing the project or plan. For example, a proposed waste incinerator may be cancelled in favour of a recycling centre with a landfill for unrecyclable waste.
- *Reduce* the impacts when avoidance is not possible, through changes in the delivery of the project. For example, the design of the incinerator site may include a new cycling lane and an environmental learning centre.
- *Repair* the damages done through restoration, remediation and rehabilitations. For example, the impacts on local roads of heavy construction traffic may be repaired through an infrastructure upgrade upon completion of the incinerator.
- *Compensate* for the damages by providing benefits comparable to what was lost. For example, loss of park area may be compensated for with new green spaces elsewhere. If this is not possible, other forms of compensation may be considered.

Finally, the SIA requires designing and implementing monitoring programmes with quantitative indicators, feedback through community participation and regular evaluation and review. Just like EIA covered some social and economic impacts, SIA tends to include some environmental impacts. However, the environmental impacts that are considered tend to be limited to those directly affecting the local community.

### BOX 3.10 AN SEIA FOR THE ADJARA SOLID WASTE PROJECT

The autonomous republic of Adjara in Georgia disposed of its waste in seven landfills, none of which complied with modern environmental standards. The Adjara Solid Waste Project aimed to close three of these and construct a new sanitary landfill. A social and environmental impact assessment (SEIA) was conducted by a Swedish engineering firm.

The impact assessment considered, among others, the social impacts of the closure of a dump near the municipality of Batumi. Interviews with waste-pickers provided insight into how many people worked on the dump or even lived there, their gender, how much they earned and how dependent their families were on this income.

Because closure of the landfill implied the loss of livelihood and, potentially, homelessness, the assessment recommended the development of a plan for resettlement and restoration of the livelihood of the waste-pickers. It emphasised that waste-pickers should not be allowed to work under the same poor conditions at another landfill but should be supported appropriately.

The new site would require resettlement of people and the report paid attention to issues such as gender inequality, observing that women were less likely to be owners of the land, and could only derive legal rights as spouses when the marriage is formally registered, which is often not the case in Georgia. Any compensation for loss of property therefore needed to consider this.

The impact assessment was followed by a stakeholder engagement plan, an environmental and social action plan and a livelihood restoration and resettlement framework. The latter specified, among others, that owners or users of the land at the new landfill site, even if not legally registered as such, were entitled to a similarly sized plot at a mutually agreed location.

Source: Sweco (2015).

#### 3.4.4 Cost-benefit analysis

Cost-benefit analysis (CBA) is a social appraisal of an investment and considers both internal (private) and external (environmental and social) costs and benefits. In a CBA, all impacts of an investment are expressed in monetary terms, including those that do not have market prices. The purpose is to provide an equal basis for comparison. For example, the environmental costs and benefits of a project, such as its CO<sub>2</sub> mitigation potential, rarely affect the feasibility of the

project for the investor. A CBA that includes CO<sub>2</sub> mitigation as a benefit with a defined value can show whether the project is attractive from an environmental point of view.

Typically, CBAs are conducted or mandated by governments because they have to consider not just economic feasibility but also the wider costs and benefits of their investment for society. A CBA may support an investment decision regarding, for example, a new road, a recycling centre or a landfill. A CBA includes the following elements:

- *Private costs and benefits.* These are the costs and benefits that would also be included by private investors and are based on market prices.
- *Environmental and social costs and benefits.* These are the costs and benefits that have no market value and that would be ignored by private investors. They may be estimated in other ways, including through surveys or analysis of behaviour, but often with high uncertainty and the risk of subjectivity.
- *Time delay.* Future costs and benefits are considered less important than current ones and are therefore adjusted downwards, reflecting the uncertainty about the future and the potential value of foregone investments.
- *Net present value (NPV).* This figure shows the net benefits (or net costs, if the number is negative) of the project based on the sum of discounted (adjusted for time delay) private and social costs and benefits over the lifetime of the project.

CBA is often thought of as comprehensive and decisive, but such an analysis is never perfect or even complete, and the results always require careful interpretation. CBAs tend to be biased towards private costs because they are easier to quantify and tend to have less uncertainty than environmental and social costs. Moreover, a CBA cannot tell whether the distribution of costs and benefits over different people is acceptable, such as when marginalised groups face most of the environmental costs (e.g., local air pollution).

### BOX 3.11 COST-BENEFIT ANALYSIS OF A LANDFILL MINING PROJECT

Yingchun landfill was an 11-hectare dumpsite in Hubei Province in central China, which received almost 1.5 million tonnes of waste between 1989 and 2004. Since the site contained various useful materials, the authorities considered extracting and recovering these, which is called landfill mining. A CBA was conducted to account for both the private and environmental costs of the project, which included capital and operational costs of mining, land reclamation, material recovery, energy recovery and avoidance of post-closure care costs, including landfill gas emissions (Table 3.3).

**Table 3.3** Costs and benefits of the Yingchun landfill mining project.

Costs	Benefits
Pre-activity research costs	Reclaimed land and airspace
Site preparation	Recyclable soil (fertiliser and substrate)
Excavation and hauling equipment	Recyclable construction waste
Screening and sorting equipment	Recyclable metals and glass
Equipment operating costs	Combustible waste for energy recovery
Material transportation	Avoidance of leachate collection and treatment costs
Material handling facilities	Avoidance of landfill gas
Final disposal costs	

The material composition of the landfill was estimated based on samples taken from depths of up to 24 metres. The researchers then calculated the costs and benefits of various scenarios regarding recovery of these materials and the use of the reclaimed land. The biggest operational costs were associated with the hauling equipment and the excavation, screening and sorting of the material. The greatest benefits were estimated for the reclaimed land and the generation of electricity and heat from the incineration of plastics and other combustibles in the excavated material.

According to the study, all landfill mining scenarios had a positive NPV. The mining eventually took place and, after the mining operations were completed, the site was transformed into an attractive public park.

Source: Zhou et al. (2015).

### 3.4.5 Input-output analysis

Environmentally extended input-output (EEIO) analysis evaluates the impacts of consumption based on the interactions between different sectors in the economy. It starts from the observation that the production activity of one sector indirectly requires an effort of all other sectors in the economy. For example, to produce potatoes, the agricultural sector requires fertiliser from that same sector, machines from the manufacturing sector and advice from the services sector. In turn, the other sectors also require inputs, including from the agricultural sector. [Figure 3.9](#) shows the linkages schematically.

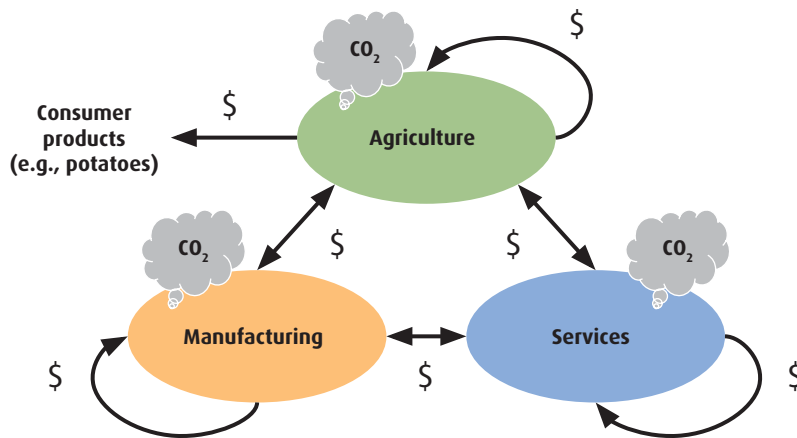

**Figure 3.9 Transactions between sectors and emissions per sector.** Image: Authors' own.

[Figure 3.9](#) also shows that each sector generates pollution. This, and the connections between all sectors, raise the following questions: to satisfy a dollar in consumer demand for agricultural products, what needs to be the output from the agricultural sector, as well as from all the other sectors of the economy? And how much pollution does this cause? With EEIO analysis, you can calculate this using three types of data.

- Monetary data tables reveal which sectors contribute to a unit of final demand (from you, the consumer). For example, they show that agriculture, manufacturing and services all contribute to each other and to themselves.
- Sectoral environmental accounts, such as CO<sub>2</sub> emission tables, show the environmental pressures per sector. Such tables cannot show the



environmental pressures of consumption; they only show the pressures from producing sectors.

- Based on the monetary exchanges, a fraction of production of each sector can be allocated to final consumer goods (e.g., agricultural goods). Based on the same exchanges, a fraction of the emissions from each sector can be allocated to a final product.

EEIO analysis is suitable for analysing the embodied impacts of downstream consumption or for calculating the embodied impacts (footprints) of goods traded between nations. Embodied impacts are also called hidden or total impacts or 'footprints'. For example, EEIO can be used to account for the emissions associated with machines from Germany that are used for potato harvesting in France. EEIO analysis is a powerful method for generating environmental data. Researchers have calculated carbon, water, ecological, nitrogen and biodiversity footprints. Besides, some LCA studies use data generated through EEIO to build lifecycle inventories.

The calculations tend to show only broad trends and cannot reveal detailed patterns, because the economic data only reflects aggregate monetary exchanges between sectors and not the trade of individual pieces of equipment or specific types of products. Besides, the monetary flows that underpin EEIO analysis mostly reflect labour costs, while the price of materials varies considerably by grade and quality – therefore, the calculations are not very accurate. Moreover, use-phase emissions (as included in LCA studies) are hard to derive with EEIO analysis. Further limitations are low-resolution sectoral data and other data availability, consistency and quality issues (Suh and Huppes 2002; Kitzes 2013).

### BOX 3.12 CONSUMPTION-BASED ACCOUNTING WITH EEIO

Can we have it all? This question summarises a longstanding debate on the possibility of combining growth of the economy with a decline in material use and environmental impacts. The potential 'decoupling' of material use from economic growth is often evidenced by comparing domestic material consumption (DMC) with GDP. The two metrics reflect respectively the aggregate material use in a country and the size of its economy.

Indeed, evidence suggests that some rich countries have reduced their DMC while growing their GDP. Unfortunately, the evidence is flawed. A large study of the global economy showed that something else is happening instead. Rather than



using less materials, rich countries have started to import manufactured goods from all over the world, with most of the associated material consumption occurring in poorer nations with large raw material and industrial sectors.

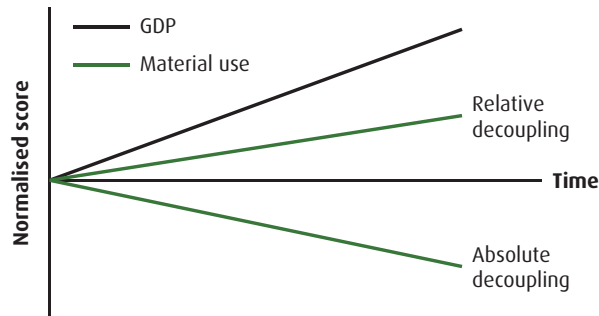

**Figure 3.10** Relative and absolute decoupling of material use from GDP.

Image: Authors' own.

On average, for every tonne of goods imported by a country, about three tonnes of material are consumed abroad in the extraction and production process. As a result, DMC per capita in, for example, the UK is fairly low and declining; in China, it is much higher and increasing. Essentially, the indicator DMC is not a fair measure of material consumption because it overlooks much of the impact of trade.

To address this, researchers calculated a material footprint, which includes both the mass of final products as well as the materials used to produce traded goods. The material footprint of rich countries tends to be higher than their DMC, as well as increasing over time. For example, for the UK, the footprint is almost perfectly proportional to its GDP, and there are no signs of decoupling in the time frame covered by the study.

These results were calculated by combining an input-output table of the world economy with material and product data. The economic database described monetary transactions between 14,787 industrial sectors across 186 countries. The researchers matched the sector economic data with figures for domestic material extraction, based on harmonised product categories.

While such an analysis yields rather imprecise results – the study identified only 35 subcategories of materials – it does show clear trends. And these trends suggest that widely used indicators for 'resource productivity', measured as GDP divided by DMC, do not provide an accurate picture of the burden associated with consumption and are suggestive of 'decoupling' when, in fact, this may not be happening at all.

Source: Wiedmann et al. (2015).

### 3.5 SUMMARY

This chapter discussed various impact assessment methods. First, we looked at MFA: the systematic assessment of stocks and flows in a system defined in time and space, guided by the material balance principle. Its purpose is to help find inefficiencies, to anticipate future depletion and accumulation of materials and to design efficient and compatible material flow systems. MFA starts with a process diagram, followed by the quantification of the stocks and flows. The results should be presented along with model and data uncertainty. A common limitation of MFA is the lack of specification of material quality and the potential impacts of the materials.

LCA goes beyond MFA by assessing environmental impacts of material flows associated with all lifecycle stages of a product or service. A lifecycle perspective avoids burden-shifting between impact categories and lifecycle stages. It is used to compare scenarios based on a functional unit, which captures the service provided by materials and products. The main steps in LCA are goal and scope definition, inventory analysis, impact assessment and interpretation of the results. The results reveal the impacts by impact category and lifecycle stage but need careful interpretation with consideration of all uncertainties.

Various other assessment methods are used to assess environmental, social and economic impacts, including EIA, SIA, CBA and EEIO. EIA and SIA are procedures to assess, mitigate and monitor the impacts of a project, plan or policy. Whereas EIA focuses on technical assessment of environmental impacts, SIA focuses on assessment of social impacts including through extensive stakeholder participation. CBA is the social appraisal of an investment and considers both internal (private) and external (environmental and social) costs and benefits, using monetary units. EEIO is a method to evaluate impacts of consumption based on the interactions between different sectors in the economy.

For any assessment, irrespective of the method, the outcomes have to be interpreted carefully. Model uncertainty arises from the choice of the scope and boundary of the analysis. Data uncertainty relates to the quality of the data and its representativeness for the application. A further consideration is bias and independence; ideally, a sustainability assessment is conducted, or at least reviewed, by independent experts without any direct or indirect interest in the outcomes, adhering to standardised methods and using verifiable data. The results, as well as the assumptions and limitations, should be transparent to the target audience.

## **3.6 REVIEW**

---

- 1.** List the main applications and methodological steps of MFA.
- 2.** Explain how an analyst can assess uncertainty in an MFA.
- 3.** List the main steps for conducting an MFA of a restaurant.
- 4.** List and then summarise each of the four main steps in LCA.
- 5.** Explain the similarities and differences between MFA and LCA.
- 6.** Describe how an LCA might compare composting and landfilling.
- 7.** Explain the main differences between EIA, SIA, CBA and EEIO.
- 8.** Provide examples of applications for each of these methods.
- 9.** Explain how you might combine the aforementioned methods.



# 4

# POLICY AND LEGISLATION

## LEARNING OBJECTIVES

After studying this chapter, you should be able to:

- explain the drivers of waste management policy and legislation
- discuss the principles and requirements of waste legislation
- describe the logic of the definition and classification of waste
- understand the types of policy instruments and their uses
- reflect on the stages and challenges of the policy process

## 4.1 INTRODUCTION

The discarding of unwanted items introduces a free-rider problem; for the individual, it is easy and convenient to dump waste just about anywhere, but if everybody did so we would collectively face immense environmental and health problems. Addressing this issue requires a collective effort, and thus the involvement of a government. This collective effort is described in this chapter, which explains the main drivers behind the policies that govern waste management and summarises the main characteristics of waste policies and the policymaking process.

Public policy covers all government action, which is taken (at least in theory) on behalf of the public. It also includes inaction; for example, if a government chooses to not address climate change, this should be considered policy too. An important component of public policy is legislation: the legally recognised outcomes of policymaking. Legislation can authorise, prohibit, promote or discourage activity. For example, waste legislation mandates the collection and sound treatment of waste and prohibits fly-tipping. Legislation can only be made by governments.

Policymaking is as much about identifying the problem as about identifying the solution. This makes it distinct from the technical side of waste management, for which problems are typically well described, such as a lack of sorting efficiency. In contrast, the definition of policy problems depends on the norms and values of all the people involved – the stakeholders in the policy problem – which could include all the citizens of a city or country. Often, it is very difficult to reach a reasonable level of agreement on what the problem is, let alone find an appropriate response.

The complexity of policymaking is inherent to the level of uncertainty regarding facts (what is happening) and values (what do we want to happen). It is also a consequence of democratic decision-making, in which relevant stakeholders must be respected and different types of evidence must be evaluated. This type of decision-making needs time to produce results but tends to result in policy

outcomes that are both acceptable in terms of the procedure (how the policy was agreed on) and the outcome (the extent to which the policy solves the problem).

The chapter starts with the historic and current drivers of waste management (Section 4.2). It then turns to key pieces of legislation, their contents and legal principles, which include some of the elements discussed previously, such as the prioritisation of waste prevention (Section 4.3). The chapter then turns to the policy instruments that can be used to address policy problems (Section 4.4) and reflects on how policy is made in practice (Section 4.5).

## 4.2 THE DRIVERS OF WASTE MANAGEMENT

### 4.2.1 Overview of the drivers

Public policy for waste management – policy that affects the collection, transport, treatment, recovery and disposal of waste – has historically been driven by three main concerns: environmental protection, protection of human health and resource conservation. Figure 4.1 shows the drivers on a timeline for developed countries. While all of these concerns remain relevant today, they gained dominance at different points in time, and have taken different shapes over time. Today, in developed countries, concerns of health and local environmental pollution have been largely addressed, and the focus is on the global environment and the resource value of waste.

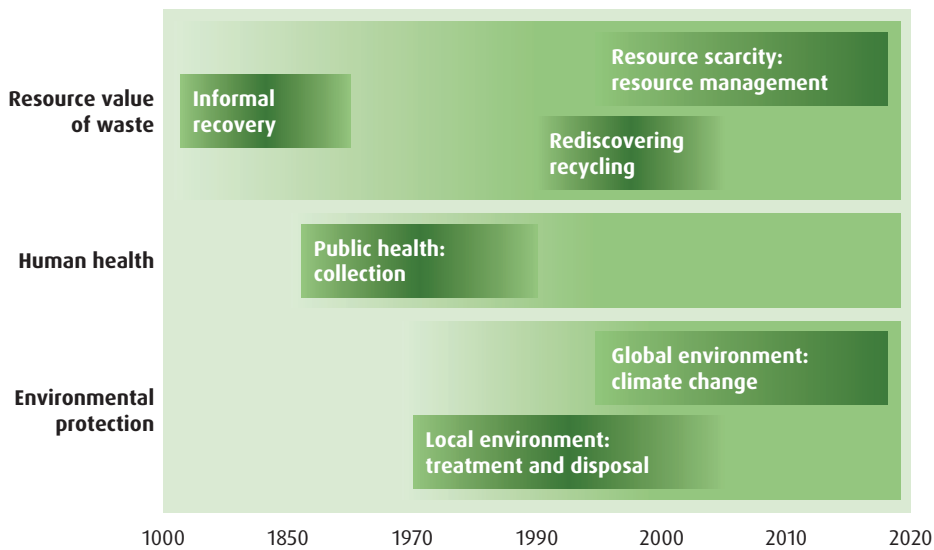

**Figure 4.1 Historical drivers of waste management.** Adapted from UNEP/ISWA (2015).



To some extent, waste management in developing countries is driven by the same concerns and they are being addressed in the same order. However, because of the globalisation of production and consumption, as well as the global nature of recently identified environmental problems, developing countries are not isolated from the concerns now prevalent in rich nations. Developing countries are therefore under pressure to address all of the concerns in [Figure 4.1](#) at the same time, which requires rapid changes in waste management technology and practices.

Globalisation has major implications for developing countries. First is the global trade in secondary resources, with developing countries often accepting waste from high-income countries for local processing. Second is the global availability of many products, even where local waste management systems are not suited to process them at the end of life. Finally, the global diffusion of modern waste management technology allows developing countries to sometimes 'leapfrog' to modern waste management solutions, such as engineered landfills with landfill gas collection systems.

#### 4.2.2 Resource value of waste

Frugality, thrift and prudence are virtues stimulated by scarcity; in the past, all but the very wealthy were careful to avoid or recover waste. Much of this ended with the industrial revolution, which introduced large-scale automated production, reduced the prices of products and made them available to a much larger share of the population. This led to an increase in convenient, disposable products and a rise in household waste generation across all socioeconomic strata. It also led to large quantities of extraction and production waste from mines, industry and manufacturing.

In the late twentieth century, recycling was on the political agenda again, mainly for its potential to reduce the landfilling of waste, which caused significant environmental problems and required increasingly expensive land. In countries with a relative abundance of space, such as the United States, concerns over landfill were mostly driven by environmental pollution from hazardous wastes, whereas in densely populated areas, such as the Netherlands, landfill posed a space issue. Today, landfill rates are much lower, mostly because of an increase in waste recycling and incineration.

Since the 1990s, governments have shown a rising interest in the wider benefits of recycling and other forms of efficient and circular use of materials as a way to address unsustainable growth in materials use and its environmental impacts. Most recently, the concept of a circular economy has gained dominance, not only for its potential environmental benefits, but also because of the potential economic benefits. Circular use of materials is seen as a way to maintain the value of materials for longer and to drive economic growth and employment. So, once again, the resource value of the waste is a main driver for developments in waste management.

### BOX 4.1 THE RETURN OF RESOURCE VALUE IN JAPAN

Edo, as Tokyo was called in the eponymous Edo period (1608–1868), featured some exemplary waste management practices. Instead of dumping human waste in cesspools or waterways, as was common in cities in the West (see [Box 4.2](#)), human waste was shipped out of the city and used in agriculture. Not only did this remove a potential problem from the city; it also delivered valuable nutrients to farmland.

During this period, Japan had a system of ‘near-complete recycling’ that relied heavily on renewable materials. The main nonrenewables were limited to iron and salt. In the towns, craftsmen repaired broken tea cups (‘kintsugi’) and recycled the ends of candles into new candles. There were environmental issues, in particular related to intensive forestry, but the period starkly contrasts with the practices that were subsequently brought on by industrialisation.

Public health and environmental concerns rose on the Japanese political agenda from the 1950s. The 1960s saw major incidents related to mercury and cadmium poisoning (‘Minamata disease’) due to industrial pollution. A range of environmental policies were introduced in the 1960s and 1970s, and in 1991 the government created a dedicated Ministry of the Environment.

In the subsequent years, the resource value of waste became a concern. Japan introduced laws related to, among others, recycling and producer responsibility. In 2000, it started an ambitious programme to establish a ‘sound material-cycle society’, which today would probably be called a ‘circular economy’. The programme marks the beginning of a potentially more comprehensive, lifecycle-oriented approach to improving waste and resource management.

The approach is often referred to with the three Rs – reduce, reuse, recycle – and considers both the input, throughput and output of materials from the economy. It aims for higher resource productivity (economic output per unit of material input), a higher cyclical use rate (reuse and recycling as a fraction of total material input) and minimisation of final waste disposal.

The ultimate aim of the programme might be a return to ‘near-complete recycling’. The ambition is sometimes illustrated with the term *Mottainai* (もったいない), which is used to exclaim, ‘What a waste’. *Mottainai* sums up a spirit of tasteful simplicity and the rejection of wasteful excess – both in the Edo period and in today’s sound material-cycle society. Unfortunately, economic growth and technological change have not made it easier to live up to its promise.

Source: Ministry of the Environment (2005); Low (2013).

### 4.2.3 Public health

In many countries, public health and waste became a major concern in the nineteenth century due to industrialisation and urbanisation. High population densities and a lack of sewer systems turned cities into unpleasant and unhealthy places. The city of London experienced the ‘Great Stink’ in the summer of 1858 and the ‘Great Smog’ in the winter of 1952. The first was caused by the open dumping of faeces and other waste, the second by the burning of brown coal without air pollution control. Both problems were addressed by legislation that shortly followed the disasters.

The standard response to waste-related health issues is universal collection and safe disposal of waste, to remove or contain any potential harm. However, public health concerns have evolved with the composition and harm of the waste that we generate. While the earliest concerns were over deadly diseases, more recent ones are over novel and potentially hazardous materials. For example, microplastics potentially affect humans through bioaccumulation. To address some of these new threats, efforts have shifted from universal collection and disposal to waste prevention.

#### BOX 4.2 WASTE IN THE TIME OF CHOLERA

The 1854 Broad Street cholera outbreak in London took hundreds of lives and made one man famous. Physician John Snow revealed that cholera is a waterborne disease and located the very origin of the outbreak. On his map of Soho, then (and now) a very crowded part of London, the victims were clearly concentrated around the Broad Street well from which they sourced their drinking water.

The Broad Street well was not far under street level and was infected with human and other waste leaking from cesspools, where such waste was routinely dumped. The cholera outbreak stopped when Snow had the handle of the Broad Street water pump removed, providing powerful evidence that cholera was a waterborne disease. Snow had previously argued this, but it took the Broad Street evidence to convince the authorities of his idea.

At the time, foul air or ‘miasma’ was credited with causing the disease and two Acts had been passed by Parliament to help local authorities deal with nuisances including ‘any foul and offensive ditch, gutter, drain, privy, cesspool, or ashpit’. The removal of nuisances was helpful to public health generally but had not addressed the root cause of cholera.



The long-term solution to cholera was the introduction of a sewage system that took human waste out of the city. At the time of Snow's investigation into the Broad Street outbreak, there had been efforts in this direction already. The new sewerage was opened in 1865, though one more cholera outbreak happened a year later in parts of East London not yet connected to the system.

While the eradication of cholera was a great success, water-based sewer systems result in other environmental problems associated with the dispersal of pollutants, including other microbiological contaminants, organic matter and other nutrients. Sewage should not just be removed from densely populated areas, but also treated before its release into the environment.

At the time of writing, some of London's sewage still ends up in the River Thames due to the limitations of the now outdated infrastructure that does not separate human waste from rainwater runoff. In 2016, work began on the Thames Tideway Tunnel, a 25-kilometre-long 'super sewer' to reduce overflows and protect the river's ecology for at least the next 100 years.

*Watch 'John Snow and the 1854 Broad Street cholera outbreak' on YouTube.*

#### 4.2.4 Environmental protection

In the second half of the twentieth century, environmental awareness greatly increased because of a number of environmental disasters, as well as a more advanced scientific understanding of our impacts on the environment. Among the concerns were the impacts on human health of landfilling hazardous waste, leakages and spills due to accidents, illegal deposits of hazardous waste and emissions from waste incinerators. The concerns related mostly to local impacts on air, soil and water.

The increased environmental awareness led to the introduction of a range of environmental policies and of dedicated government ministries, departments or agencies in the 1960s and 1970s, such as the United States Environmental Protection Agency (US EPA) in 1970. Some of the key legislation, such as the US Solid Waste Disposal Act of 1965, was introduced around this time and has been amended and complemented with other legislation over time.

Local environmental problems are still very important today but, in addition, various global environmental problems related to waste have been identified, including climate change. Waste generation and treatment is relevant to climate change in many ways, including because of landfill gas releases, potential energy savings through recycling and recovery and the potential to reduce emissions early in the lifecycle through a more efficient and circular material system.

### BOX 4.3 NOT SUCH A LOVELY CANAL

In 1978, for the first time, the president of the United States declared a state of emergency for a manmade environmental problem. Whereas previous emergencies had been caused by hurricanes or wildfires, this time it was 21,000 short tons (approximately 19,000 metric tonnes) of hazardous chemical waste underneath a residential neighbourhood, which was pleasantly named Love Canal.

The name derives from the 1890s, when William T. Love started building a canal between the upper and lower Niagara Rivers with the aim of producing hydropower electricity. The project was abandoned but the structure remained and became a dumpsite. From 1942 to 1953, the Hooker Chemical Company used the site to dispose of hazardous waste.

The land was then sold, and a school and a residential neighbourhood were erected on the site. Along with the chemical waste, complaints surfaced. Residents noted strange odours and puddles of unknown substances. Despite the clay capping layer, and in part due to heavy rains, chemical wastes leached into basements and barrels of waste made their way to the surface.

An EPA administrator recorded his experience at Love Canal in a 1979 article. 'Corroding waste-disposal drums could be seen breaking up through the grounds of backyards. Trees and gardens were turning black and dying. ... Everywhere the air had a faint, choking smell. Children returned from play with burns on their hands and faces.'

The wastes contained highly toxic compounds such as benzene and dioxins. A lack of scientific knowledge on the health risks of these substances led residents to tally impacts for themselves, revealing unusual numbers of miscarriages, birth defects and illnesses. Today, we know much more about hazardous waste impacts, but the health impacts at Love Canal remain disputed, as well as the legal responsibility for them.

At the time, the disposal methods of the Hooker Chemical Company were legal and commonly practised across the United States. The company had communicated the presence of the waste upon selling the land, but its precise composition was not known. Worse still, the protective clay cover was found to be much too thin in places. Much of the neighbourhood was evacuated and is now fenced off.

The incident spurred the creation of the US Comprehensive Environmental Response, Compensation and Liability Act of 1980 (CERCLA), and the associated 'Superfund' trust fund set up by US Congress for the identification and clean-up of similar sites across the United States, of which there were many. The Love Canal disaster was far from the legacy William T. Love had in mind when he first started digging, but it changed policy and legislation for the better.

Source: Engelhaupt (2008); Beck (1979).

## 4.3 WASTE LEGISLATION

### 4.3.1 Major waste laws

Modern waste legislation is driven by all three concerns detailed in [Section 4.2](#): environmental protection, human health and the resource value of waste. This section introduces key legislation from the EU, the United States and China, as well as international legislation. The subsequent sections will explore key aspects of the legislation, drawing on examples from the different laws. Even if you do not live in the EU, the United States or China, the legislation for these three jurisdictions is still very relevant because it affects global waste trade and management and also inspires legislation elsewhere.

- In the EU, the *Waste Framework Directive* (WFD) was first adopted in 1975 and has been updated at various times, including in 2008.
- In the United States, the most important waste law is popularly known as the *Resource Conservation and Recovery Act* (RCRA), which was the subtitle to the 1976 amendment to the *Solid Waste Disposal Act* of 1965. The RCRA has been amended at various times since 1976.
- In China, the *Law of the People's Republic of China on the Prevention and Control of Environment Pollution Caused by Solid Wastes*, or in short the *Solid Waste Law*, was first introduced in 1995 and the fifth amendment was adopted in 2020.

All three laws directly or indirectly (through supporting legislation) do the following: define waste; offer a system for waste classification; and lay down the principles for waste management.

Internationally, several conventions have been adopted related to waste prevention, trade and management. Conventions are typically adopted by countries ('parties') at international meetings led by the United Nations, often held in the cities the convention is named after, then ratified by the national governments of the different parties. A convention becomes binding when a pre-agreed number of parties has ratified it. While the process can take many years, many governments implement national legislation before the convention becomes binding.

- The 1972 *London Convention on the Prevention of Marine Pollution by Dumping of Wastes and Other Matter*, or in short the *London Dumping Convention*, came into force in 1975 and limited the disposal of waste from vessels, aircraft and platforms. It was updated by the stricter 1996 *London Protocol*, which came into force in 2006 and prohibits almost any marine dumping.

- The 1989 *Basel Convention on the Control of Transboundary Movements of Hazardous Wastes and their Disposal* promotes the reduction of hazardous waste generation, better waste treatment and limitations on the trade of hazardous waste from high-income to low-income countries (see also [Box 4.4](#)). The Basel Convention entered into force in 1992.
- The 2001 *Stockholm Convention on Persistent Organic Pollutants* aims to prevent the use of persistent organic pollutants (POPs), which accumulate in the environment and adversely affect human health and ecosystems. The initial list of POPs has been expanded to cover new substances. The Stockholm Convention entered into force in 2004.
- The 2013 *Minamata Convention on Mercury* regulates the use of mercury in processes and products, with the aim of greatly reducing mercury pollution. It was not adopted in the city of Minamata but refers to the mercury poisoning disaster that happened there. The Minamata Convention came into force in 2017.

The next few sections focus on the key elements of waste legislation: the definition of waste, its classification and management principles. The sections will draw on examples from waste law in the EU, US and China, focusing on the similarities rather than the differences to show the typical contents of waste legislation. [Exercise 4.1](#) invites you to explore the laws by yourself first, or, if you live outside of these three jurisdictions, to explore the relevant waste law in your country.

#### EXERCISE 4.1 MAJOR LEGISLATION IN YOUR COUNTRY

Pick the regional (EU) or national (US, China) waste law that applies to you or search the internet for the relevant waste legislation in your country. Keep in mind that not all waste law has 'waste' in its title; it may be part of a more comprehensive law on, for example, environmental protection or pollution. Have a look at the actual text of the law and try to list the key characteristics by answering the following questions.

- When was it adopted? What legislation preceded it?
- What aims and goals does the introductory part list?
- What subjects are covered under the various headings?
- How is waste defined? What system is offered for classification?
- How does the law suggest waste should be managed?

### 4.3.2 The definition of waste

The definition of waste is the cornerstone of waste law because it decides its scope; only when something is defined as waste does waste law apply. This section looks at the definition of waste in the EU, US and China. Direct quotation is made only from the former two laws because there is no official English translation of the Chinese waste law.

The legislation from the three jurisdictions reveals four elements of the definition of waste. First, waste is typically defined by it being discarded. The following excerpt is from the definition of waste in the United States, taken from the RCRA.

*The term 'solid waste' means any garbage, refuse, sludge from a waste treatment plant, water supply treatment plant, or air pollution control facility and other discarded material, including solid, liquid, semisolid, or contained gaseous material resulting from industrial, commercial, mining, and agricultural operations, and from community activities ...*

In short, the United States defines solid waste as anything that is discarded. The EU defines waste very concisely as 'any substance or object which the holder discards' and the Chinese waste law emphasises that even valuable items are waste if they were discarded.

Second, the Chinese and EU definitions also mention that some materials are waste by force of other regulations. In the EU definition of waste, this is phrased by referring to objects that the holder is 'required to discard'. For example, metallic mercury from nonferrous mining and smelting operations must be discarded as waste according to a separate regulation (EC 2008b). Whether the holder of the waste really wants to discard the material does not matter in this case; the law says it must be discarded (because mercury is very toxic).

Third, certain discarded materials are excluded from the definition of waste. In the RCRA, the exclusions are listed in the definition; the text below follows directly on from the previous excerpt.

*... but does not include solid or dissolved material in domestic sewage, or solid or dissolved materials in irrigation return flows or industrial discharges which are point sources subject to permits under section 402 of the Federal Water Pollution Control Act, as amended (86 Stat. 880), or source, special nuclear, or byproduct material as defined by the Atomic Energy Act of 1954, as amended (68 Stat. 923).*



In the EU and China, similar exclusions are made, but they are listed in a separate clause regarding the scope of the law. Like in the United States, the exclusions are for, among others, wastewater and nuclear waste, because these are governed by separate legislation that is specifically designed to deal with the distinct challenges presented by those types of waste (they are also excluded from this book).

Fourth, the law typically makes provisions for recovered materials, which are no longer waste. The Chinese Solid Waste Law states that materials are not waste when they have been processed, meet product standards and no longer pose a health or ecological risk. In the United States, specific materials are excluded from the definition, among others to promote recycling, including various kinds of scrap metal: home scrap metal (e.g., produced by a mill), prompt scrap metal (e.g., from a workshop) and processed scrap metal (e.g., baled or shredded for the purpose of recycling).

In the WFD, the criteria for processed waste are called the ‘end-of-waste’ criteria. Waste is no longer waste when it has undergone a recovery operation and meets all of the following criteria.

- (a) The substance or object is commonly used for specific purposes.
- (b) A market or demand exists for such a substance or object.
- (c) The substance or object fulfils the technical requirements for the specific purposes and meets the existing legislation and standards applicable to products.
- (d) The use of the substance or object will not lead to overall adverse environmental or human health impacts.

The end-of-waste criteria have been further specified in regulations, including for iron, steel and aluminium. For example, the regulations state that metal scrap must have been separated from other waste and meet certain criteria regarding purity to qualify as non-waste.

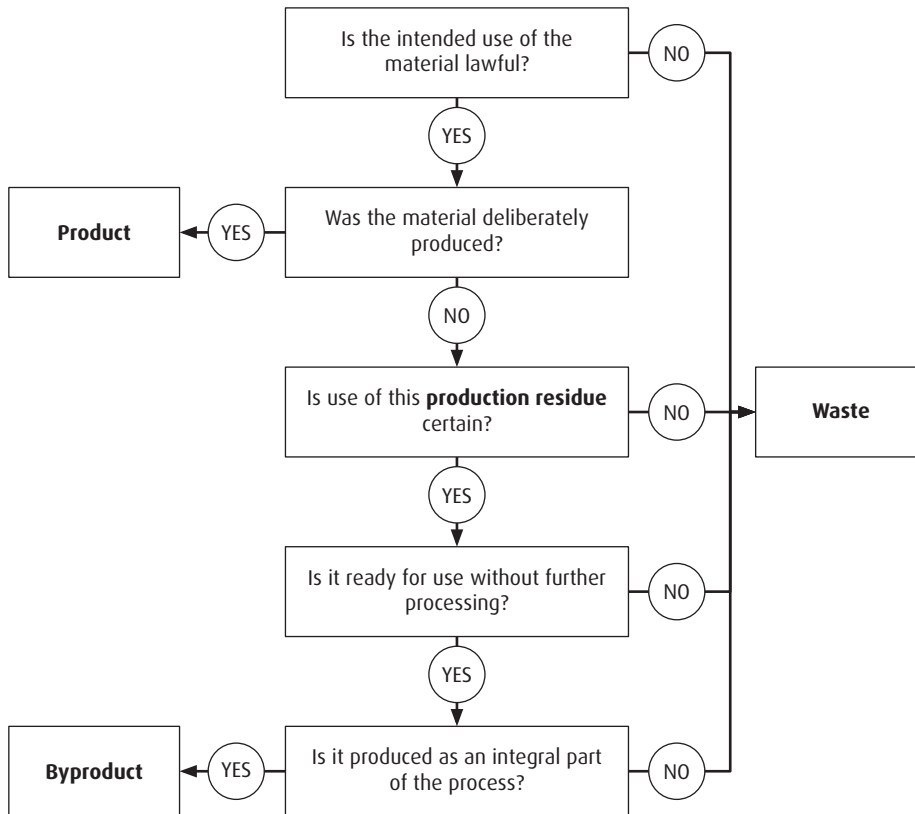

**Figure 4.2 Deciding whether a material is waste or a byproduct.** Adapted from EC (2007).

The WFD makes another, less common, distinction: byproducts are defined as a production residue that does not have to be handled as waste. Figure 4.2 shows the criteria for byproducts in a decision diagram. It shows that a material is a byproduct if further use of it is certain, if it can be used without further processing other than normal industrial practice and if it is an integral part of a production process. The use of byproducts must also meet existing regulations, such as product standards, and should not lead to overall adverse environmental or human health impacts.

### 4.3.3 Waste classification

The definition of waste is only the starting point for waste regulation. It defines the scope of the materials that are subject to further requirements, which are essentially designed to keep track of waste and control its impact. The requirements include permits for waste facilities, a ‘duty of care’ for waste and an obligation to

classify waste. Each of these are explained below, based on the guidance provided by the UK government, but other countries have similar requirements.

- You need a permit if you engage in an activity that could, among others, ‘pollute the air, water or land’ (EA/DEFRA 2020). Facilities that require a permit include, among others, sites ‘where waste is recycled, stored, treated or disposed of’. In other words, almost anyone dealing with waste needs a permit to do so.
- ‘The duty of care legislation makes provision for the safe management of waste to protect human health and the environment. ... The duty of care applies to anyone who imports, produces, carries, keeps, treats, disposes of, or are a dealer or broker that has control of, controlled waste’ (DEFRA 2018).
- ‘As part of your waste duty of care you must classify the waste your business produces: before it is collected, disposed of or recovered; to identify the controls that apply to the movement of the waste; to complete waste documents and records; to identify suitably authorised waste management options; to prevent harm to people and the environment’ (EA/SEPA/NRW 2021).

Waste classification is based on a standardised list of waste types. In some jurisdictions, including the EU and the UK, the data is centrally collected for the purpose of planning and policymaking, and the aggregate figures are published by the national and European statistics agencies. This is the data shown in [Figures 1.6 and 1.12 in Chapter 1](#).

Waste classification is necessary to ensure safe management and consists of describing the waste according to a predefined list of waste types. For example, in the EU, the European List of Wastes (LoW), which is also used in the UK, provides a standardised description of waste. The relevant legislation references this list when specifying recommended operations, restrictions or any other regulatory requirements.

Someone running a business in the UK (or in one of many other countries with similar legislation) would have to take the following steps to classify waste:

1. Find out whether the material is truly ‘waste’ and not, for example, a byproduct (see [Section 4.3.2](#) on the definition of waste).
2. Identify the correct waste code or codes that apply to the waste. An example of waste codes is provided in [Table 4.1](#).

3. Establish whether the waste is by definition hazardous or nonhazardous, or if it needs to be tested for hazardousness.
4. If the waste indeed needs to be tested, find out its composition, either by referencing existent information (e.g., the manufacturer's safety sheet) or through chemical analysis of a representative sample.
5. Establish whether anything found in the chemical analysis qualifies as a listed 'hazardous substance' or a persistent organic pollutant (POP). In the case of uncertainty, a reasonable worst case must be assumed.
6. Assess the hazardous properties of the waste based on its composition and the hazard presented by the individual components.
7. Finally, fill out the 'consignment note' by assigning a waste code and, when relevant, specify the hazardous properties of the waste.

Once the waste is classified, legislation prescribes which procedure must be followed for its safe movement, storage, treatment and disposal, and who is permitted to do so. Together, the classifications by different waste holders form a 'chain of custody' that describes the path of a waste from generation to final treatment. The chain of custody helps businesses establish what they are dealing with and is an important tool for the enforcement of government regulations.

Other countries have classification systems similar to that of the UK. In the United States, hazardous waste is classified based on lists of processes and industries that typically generate such wastes (e.g., 'Electroplating and other metal finishing'), lists of materials that qualify as hazardous (e.g., 'Wastewater treatment sludge from the production of zinc yellow pigments') and standards for measuring and evaluating the hazardous character of any waste (e.g., 'ignitability').

**Table 4.1 The chapters of the European List of Wastes (LoW), including the first two entries of the first three chapters. The LoW distinguishes 839 types of waste.**

Code	Name
01	Wastes resulting from exploration, mining, quarrying, physical and chemical treatment of minerals
01 01	Wastes from mineral excavation
01 01 01	Wastes from mineral metalliferous excavation
02	Wastes from agriculture, horticulture, aquaculture, forestry, hunting and fishing, food preparation and processing
02 01	Wastes from agriculture, horticulture, aquaculture, forestry, hunting and fishing
02 01 01	Sludges from washing and cleaning
03	Wastes from wood processing and the production of panels and furniture, pulp, paper and cardboard



**Table 4.1 (Cont.)**

Code	Name
03 01	Wastes from wood processing and the production of panels and furniture
03 01 01	Waste bark and cork
04	Wastes from the leather, fur and textile industries
05	Wastes from petroleum refining, natural gas purification and pyrolytic treatment of coal
06	Wastes from inorganic chemical processes
07	Wastes from organic chemical processes
08	Wastes from the manufacture, formulation, supply and use (MFSU) of coatings (paints, varnishes and vitreous enamels), adhesives, sealants and printing inks
09	Wastes from the photographic industry
10	Wastes from thermal processes
11	Wastes from chemical surface treatment and coating of metals and other materials; nonferrous hydrometallurgy
12	Wastes from shaping and physical and mechanical surface treatment of metals and plastics
13	Oil wastes and wastes of liquid fuels (except edible oils, 05 and 12)
14	Waste organic solvents, refrigerants and propellants (except 07 and 08)
15	Waste packaging, absorbents, wiping cloths, filter materials and protective clothing not otherwise specified
16	Wastes not otherwise specified in the list
17	Construction and demolition wastes (including excavated soil from contaminated sites)
18	Wastes from human or animal healthcare and/or related research (except kitchen and restaurant wastes not arising from immediate healthcare)
19	Wastes from waste management facilities, off-site wastewater treatment plants and the preparation of water intended for human consumption and water for industrial use
20	Municipal wastes (household waste and similar commercial, industrial and institutional wastes) including separately collected fractions

#### 4.3.4 Legal principles

Besides a definition of waste and systems for waste classification, national and international waste law draws on a set of legal principles. Among the main legal principles are the prevention principle (prevention is better than cure), the precautionary principle (better safe than sorry) and the polluter-pays principle (blame where blame is due). The next three paragraphs explain each of these three principles in more detail.

The prevention principle is firmly established in waste policy and other environmental policy. In waste policy, it is clearly represented by the waste hierarchy, as explained in [Section 1.5.2](#). The waste hierarchy, or the three Rs,

prioritise prevention or reduction over reuse, recycling and recovery. This book respects the priority order by discussing prevention and reuse (Chapter 5) before collection, treatment, recovery and disposal (Chapters 6 to 8). The logic behind prioritising prevention is straightforward: preventing a problem in the first place saves the effort of repairing, undoing or fixing the problem.

The precautionary principle responds to one of the major challenges in environmental protection: gathering evidence to justify action. Almost by definition, new materials, products and practices have unknown environmental impacts. While products can be tested before market introduction and legislators could ban their use based on the results, the required science may not yet exist or may require long-term studies. Regulators, therefore, have to weigh the importance of unknown potential impacts. The precautionary principle is controversial because it is difficult to decide how much precaution is appropriate for any given situation.

The polluter-pays principle is a guiding principle of environmental law in many regions. It states that the cost of pollution or its management should be borne by the polluter. Adherence to the principle should lead to more efficient and effective waste prevention and correspond to a general idea of fairness. It may be applied by including the cost of pollution in the prices of goods and services through taxation. The polluter-pays principle and the prevention principle go hand-in-hand. After all, it is the polluter who is often in the best position to prevent waste; requiring them to pay creates an incentive to actually prevent the waste.

## 4.4 POLICY INSTRUMENTS

### 4.4.1 Overview of instruments

The definition and classification of waste are examples of policy instruments to regulate waste management. This section provides an overview of such regulatory instruments, as well as other types of policy instruments. Often, achieving a single outcome requires multiple instruments. For example, consider the measures that a national government needs to take to ensure that households separate their waste into recyclable fractions.

- Introducing a requirement for waste operators to organise multistream waste collection. This is an example of a ‘hard’ regulatory measure since it is legally binding – the waste operator must comply or will be out of business.
- Facilitating the development of standards for categorising recyclables by a representative industry body. This is a ‘soft’ measure that does not typically require enforcement because such standards are in the interest of industry.

- Informing citizens with postal leaflets about how to discard their waste to ensure correct separation of waste. This policy is an ‘information’ instrument since it aims to educate and inform relevant actors.
- Implementing separate charges for residual and recyclable waste collection to cover the cost of collection and make recycling economically attractive to households. Since this instrument affects prices, it is an economic instrument.

Further policies may be required to coordinate between different levels of government. For example, a national government may introduce ‘hard’ regulation that demands the introduction of economic instruments at the local level. The next few sections explain the main types of policy instruments: regulatory, voluntary, information and economic.

#### 4.4.2 Regulatory instruments

Hard, legally binding instruments are necessary to deal with potentially harmful activities that should not happen or that require strict safety precautions. Waste regulation and policy is very much informed by environmental and health risks and therefore often involves ‘hard’ regulatory instruments. The instruments include the definition of waste and waste lists, permit requirements for waste management operators, obligations to discard certain wastes, health and safety regulations and waste-specific bans on transport, treatment and disposal methods.

Regulatory instruments can be inefficient because they do not allow flexible solutions to problems. However, they are often necessary to avoid potentially dangerous situations. To be effective, they require monitoring and enforcement. For example, public servants or the police may be charged with identifying ‘waste crime’ such as fly-tipping and trafficking. Small offences tend to be fined, but major offences, such as illegal disposal of hazardous waste by businesses, can lead to prison sentences. Stringent oversight can be difficult and costly for government.

Regulation can protect the environment but also hurt business interests, employment and the economy. For example, banning harmful products can bankrupt manufacturers who rely on them. Naturally, potentially affected industries resist the introduction of hard regulation and warn politicians of job losses among voters in their constituencies. The introduction of hard regulation often requires a sense of urgency, strong political will and widespread public support. These conditions are often met after high-profile environmental disasters (see [Box 4.4](#)).

#### BOX 4.4 *KHIAN SEA AND THE BASEL CONVENTION*

In 1984, the US city of Philadelphia faced a major problem. Starting in the 1970s, it had been incinerating most of its waste and landfilling the ash in New Jersey. But now New Jersey had classified the ash as hazardous waste because of high concentrations of toxins, including arsenic, cadmium, lead and mercury and refused to take any more of it. Six other US states also refused to take the waste.

Where to go with 180,000 tonnes of ash every year? The initial choice was other countries with less stringent environmental regulations, but this turned out to be difficult. The first shipment of ash aboard the freight ship *Khian Sea* was rejected by the Bahamas, then by the Dominican Republic, Honduras, Panama, Bermuda, Guinea Bissau and the Netherlands Antilles.

In late 1987, the operators convinced the Haitian government to take the 'fertiliser' and 4,000 short tonnes (approximately 3,600 metric tonnes) of incinerator ash were dumped on a beach near the city of Gonaives. By the time the non-governmental environmental organisation Greenpeace revealed that the ash was not fertiliser, the ship had already disappeared. For two years it roamed the oceans, visiting 11 countries and changing its name twice.

In the end, all of the remaining cargo mysteriously disappeared when the ship was on the Indian Ocean between Singapore and Sri Lanka. While the ash ended up in the ocean, the businessmen that were responsible ended up behind bars.

The *Khian Sea* was only one of many problematic international shipments of hazardous waste. To address the issue, strict regulation seemed inevitable, and the Basel Convention on hazardous waste was adopted in 1989 and entered into force in 1992. The convention requires that transboundary waste shipments follow the 'prior informed consent' procedure; a shipment should only be allowed to leave a country if the receiving country has agreed to take the shipment, having full knowledge of its contents. It also stipulates that waste should be prevented or treated in an environmentally sound manner, preferentially close to its origin.

The Basel Convention has been ratified by almost every country and is considered a success. However, some people initially argued that the convention legitimised hazardous waste trade. An amendment to the convention was adopted in 1995, which prohibits any hazardous waste movement from a defined group of high-income countries to other countries. To enter into force, the amendment had to be ratified by a sufficient number of signatories, which was achieved in 2019.

Source: UNEP/SBC, n.d.; Cunningham and Cunningham (2004); UNEP (2019).



### 4.4.3 Voluntary instruments

Voluntary instruments cover a range of approaches to policymaking, none of which are legally binding. For example, an industry may agree on a code of conduct or performance targets and have these formalised and monitored by a dedicated body. The advantage of such an agreement is that it is tailored to the industry and allows for flexibility. The disadvantage is that voluntary agreements tend to only work well when the intended outcomes are in the immediate interest of industry, which is rarely the case for environmental problems.

There are various types of voluntary agreements. First, a government may organise programmes to which firms can voluntarily commit, such as environmental accreditation (see [Box 4.5](#)). The potential benefits for companies are largely in terms of public image. Second, a government may negotiate an agreement with industry, or even with selected firms. Firms may be interested in this to avoid hard regulation. Third, industry may autonomously anticipate regulation and devise its own programmes for improving performance and thereby prevent government from stepping in.

For a voluntary agreement to have credibility, it should have clear targets, independent monitoring and penalties for the non-compliance of individual firms. Both the objectives and measurement of progress should be clear, transparent and public. Most importantly, government must maintain a credible threat of the introduction of hard regulation to provide the necessary pressure for industry to abide by the agreement. In some cases, public concern over environmental issues can create the necessary pressure for collective voluntary action.

#### **BOX 4.5 ISO 14001: A VERY SUCCESSFUL VOLUNTARY PROGRAMME?**

The most widely adopted voluntary environmental programme is arguably the ISO 14001 standard, which sets out the requirements for environmental management systems for companies. It focuses on the identification, management, monitoring and control of environmental issues and provides practical guidance on how to do this.

The standard was developed by the International Organization of Standardization (ISO), an international non-governmental organisation with 164 national standards bodies as members. ISO standard 14001 is voluntarily adopted by companies for a variety of reasons, but mainly for branding purposes towards suppliers and customers.



The basic principle of the standard is a four-step cycle. First, the organisation should plan environmental objectives and identify required processes. Second, the processes should be implemented. Third, the processes should be measured and monitored and the results reported. Fourth, the results should be evaluated to identify further needs for action.

In terms of adoption, the standard has undeniably been a success, with 361,000 companies reported to adhere to the standard in 2017. However, the standard only provides guidance on processes and does not set environmental goals. Adoption may improve environmental performance but there is no guarantee.

Measuring the environmental effectiveness of the standard is difficult since companies voluntarily adopt it, with the best-performing companies more likely to adopt the standard to begin with. Some studies show that the standards lead to significant improvement, but there are also studies that show there is no significant improvement, or even worse performance, upon adoption. The adoption of the standard has been found to have more impact in countries with weak regulations, because there is more room for improvement.

The standard leaves considerable freedom; companies can choose their own targets, which is likely to lead to a focus on more visible environmental impacts, and they can evidence compliance in various ways. Companies can self-declare adherence to the standard, or they can seek third-party verification, with the latter option having more credibility.

The effectiveness of a voluntary standard is largely the result of an inevitable trade-off. To be effective at the company level, the standard needs to be sufficiently strict to lead to real improvement in environmental performance. However, to ensure the adherence of many firms (which enhances the overall impact), the standard should not be too strict.

Whether ISO 14001 has struck the right balance remains elusive. It is clear that the standard cannot bring about the change that binding regulatory instruments can. However, binding instruments are not always feasible, and voluntary standards may therefore be attractive in selected circumstances, potentially in combination with other policy instruments.

Source: Prakash and Potoski (2007); Boiral et al. (2018).

#### 4.4.4 Information instruments

Information instruments can be used when behaviour is strongly dependent on the knowledge of the individual or organisation. There are two types of information instruments. First, when information is known to a government but not to the target groups, the information can be shared through activities such as government publicity campaigns, educational programmes, training, guidance or guidelines. For example, many countries have anti-litter campaigns (see [Box 4.6](#)) and distribute guidance on household source-separation.

Second, when information is not available to anyone, policies such as reporting requirements for companies can help to produce the relevant information. An example are the various waste generation and treatment reporting requirements in EU member states, which generate data on how much waste is generated and treated. The aggregated data is freely available online and widely used by businesses, consultancies and governments for business decisions and policymaking (it is, hence, a policy that supports other policies).

Information instruments of the first type can be successful but knowledge about a certain practice alone is rarely sufficient to convince consumers or companies to engage in it. Generally, behaviour is determined not only by our knowledge but also our skills, habits, motivations and our physical environment. For example, household recycling requires the knowledge of what goes where, but also time and effort and the wide availability of bins. Individuals may be insufficiently motivated to act (or even to absorb the information) and held back by a longstanding habit of disposing of all waste in the nearest bin.

#### BOX 4.6 DON'T MESS WITH TEXAS

Anti-litter campaigns are rarely enough to change behaviour, let alone make people proud. Yet this happened with the slogan 'Don't mess with Texas', which has been widely used by Texans to express their love of their home state. The line even made it into the acceptance speech of US president George W. Bush, previously governor of Texas.

The slogan was invented by Tim McClure at Austin-based advertising agency GSD&M, which was hired by the Texas Department of Transportation to solve the problem of litter along Texas highways. Clean-up costs were rising quickly, and research found that the litter was largely caused by the irresponsible behaviour of males aged 16–24.



The slogan was printed on bumper stickers that were made available at truck stops and fast-food restaurants. According to its inventor, the slogan had the right level of 'Texas bravado' and did not mention the department or its true purpose. McClure: 'We thought the way to get it into the public's consciousness quickest was to let Texans own it.'

The campaign launched in 1986 with a commercial featuring Texas blues musician Stevie Ray Vaughan, who confidently tells viewers to not mess with his state. Many other commercials with other musicians followed, as well as a large variety of merchandise; in 2002, the department trademarked the slogan to ensure royalties from its use.

It is tempting to call the campaign a success even before considering whether it actually reduced litter. Fortunately, it did; four years after the launch of the campaign, in 1990, highway litter was estimated to be down by 72 per cent. This reduction was not achieved solely through the provision of information; besides bumper stickers, there were new trash cans carrying the slogan.

*Watch the commercials at the [DontMessWithTexasTV YouTube channel](#).*

Source: Nodjimbadem (2017).

#### 4.4.5 Economic instruments

Economic theory suggests that government should intervene when markets fail. For example, when the 'external cost' of environmental pollution is not included in the product price, demand for the product will be higher than justified by its benefits for society. Government can correct this by adding the environmental costs to the product price in the form of a tax ('internalise the externality'). A well-designed tax leads to a sufficient increase in price to reduce demand and the associated pollution to the appropriate level.

Economic instruments affect the market price of products or activities but leave it to market actors to decide whether to pay these prices. Besides taxes, governments can introduce subsidies (the opposite of taxes), fines (for illegal activities), deposit-refund schemes (for returnable items) and tradable permit schemes, such as for carbon emissions. The latter consists of introducing 'rights' or 'permits' to engage in a polluting activity. By supplying a limited number of permits, total pollution is capped. The fewer the permits, the higher the price; businesses can choose to buy permits or reduce their pollution.

Economic instruments can be very efficient because they do not prescribe technical solutions. Instead, they change prices and leave it to individuals or

businesses to respond in a way the best suits them. This allows more freedom to individuals and, importantly, allows businesses to act based on their technical and market knowledge, which government often lacks. Making pollution costly is rarely enough to shape business and consumer behaviour; additional government effort may focus on stimulating research and development into environmentally friendly solutions.

#### BOX 4.7 WHAT IS THE RIGHT PRICE FOR LANDFILLING WASTE?

In the early 1990s, more than 90 per cent of UK MSW was landfilled, a much greater fraction than in many other EU member states. To reduce landfill, the government introduced a tax in 1996, which had to be paid per tonne of waste to landfill.

The policy was preceded by years of discussion and analysis, including an estimate in 1993 of the external costs of landfill. The analysis covered climate change, air pollution, transport impacts and leachates. It also covered disamenity costs such as from noise and odour based on US data, because no UK-specific data was available.

The assessment concluded on a total cost of landfill of around £5/tonne of waste. The initial tax rates were set at £2/tonne for inert waste such as sand and gravel and £7/tonne for all other waste, with a few exceptions. [Figure 4.3](#) shows the historical tax rate and the amount of waste to landfill over time.

Though the initial tax reflected the estimated externality costs, it was not high enough to achieve the desired reductions in landfill. The government increased the tax rate over time; two decades after its introduction, it had risen to £2.65/tonne and £84.40/tonne. In the same period, MSW landfill rates dropped to about 20 per cent, with recycling increasing to 44 per cent and incineration to 34 per cent.

The rise of the incineration rate (at the expense of recycling) was to be expected; the next-cheapest option after landfill tends to be incineration. A landfill tax alone is therefore not enough to achieve the highest priorities in the waste hierarchy – it merely avoids the lowest priority.

The UK landfill tax also shows that externality pricing does not necessarily achieve the desired outcomes; the tax needed to far exceed the externality costs. Was the estimate of the externality costs too low? Or was the tax too high and the current landfill rate unnecessarily low, given the costs to the environment and society?



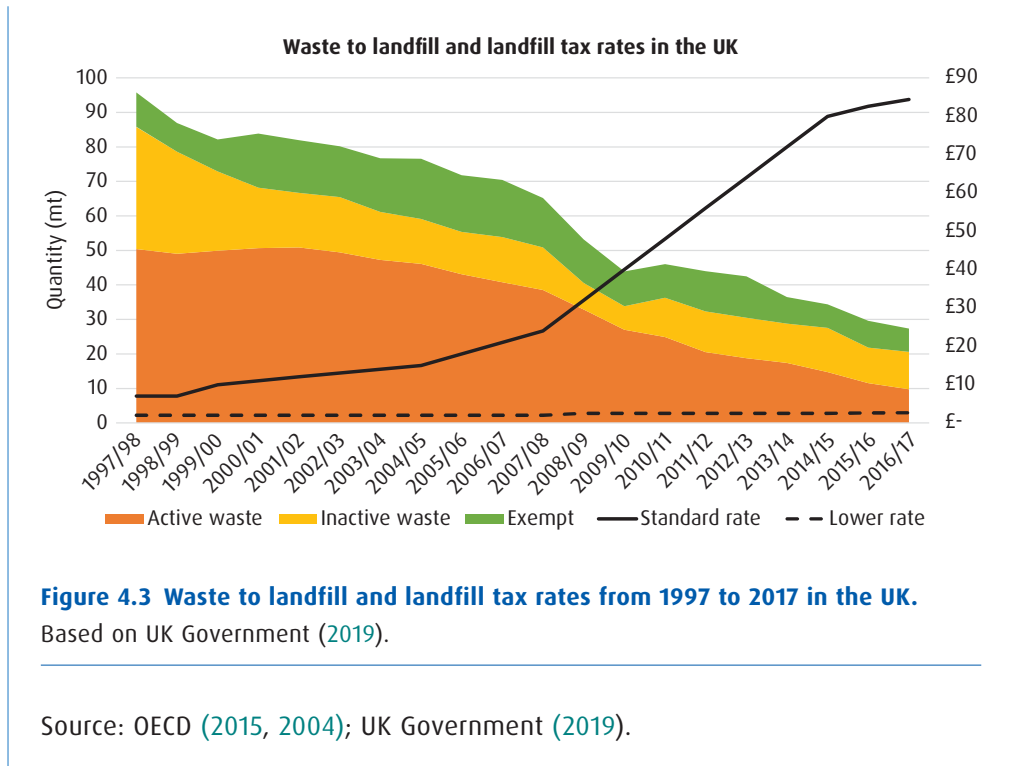

## 4.5 THE MAKING OF POLICY

### 4.5.1 The policy process

In the final section of this chapter, we discuss how policies come about. [Figure 4.4](#) presents a highly stylised model of the policy process. It starts with the definition of the problem, followed by the design of a policy that addresses the problem, which is then implemented and evaluated. The process starts over when the evaluation shows that the problem has not been (fully) addressed.

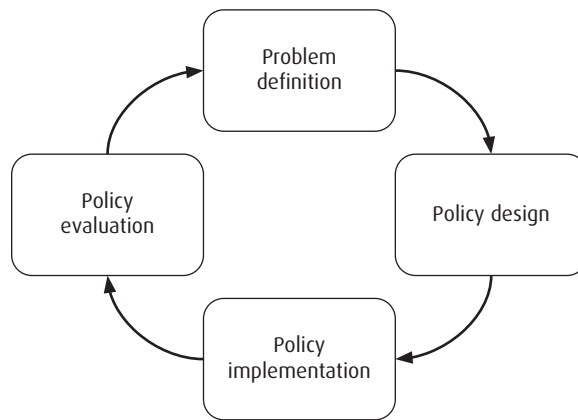

**Figure 4.4 A stylised representation of the policy process as a cycle.** Image: Authors' own.

The stylised policy process is prescriptive rather than descriptive: it explains how policy is ideally made and provides guidance to policymakers, but only partly explains how policy change actually comes about in the far more complex reality. To understand policy change, at least the following challenges should be considered (adapted from Sabatier 2007).

1. *Policy actors.* Hundreds of actors may be involved in a policy problem, including national and local politicians, various levels of government, governmental agencies, non-governmental organisations (NGOs), academics, business leaders, journalists and interest groups. Each actor has a different take on the problem and will argue for different solutions. For example, the circular economy has been promoted by environmentalists and the private sector using very different environmental and economic arguments.
2. *Time duration.* Policymaking tends to take a long time and the introduction of a policy is often the result of a decadal process of exchanges between the various policy actors and the accumulation of evidence to understand the factual basis for both the problem description and the problem solution. Climate change presents an extreme example; the first evidence regarding the link between CO<sub>2</sub> and the climate was published in 1896 but a comprehensive policy response is still lacking.

3. *Levels and scales.* Policy programmes to address a policy problem, such as plastic bag litter, exist at many levels and scales and may be run by city governments, state governments, national governments or the UN. These programmes have overlapping jurisdictions and the same actors are often involved. The introduction of a single policy, such as a national ban on plastic bags at retailers, inevitably requires a process at these different levels and scales, as well as co-ordination between them.
4. *Policy debates.* Policymakers are not afforded the luxury of having a series of meetings in which the policy problem and solution are mutually agreed. Instead, discussions over a policy problem and potential solutions are conducted in various arenas, including parliament, newspapers, town hall meetings, consultation sessions, panel discussions, scientific conferences and court cases. This large variety of debates, among the many different policy actors, together shapes policy change.
5. *Power and interests.* Policy is rarely the product of a reasoned comparison of various arguments. Instead, power and interest play a large role. Many policy actors have private interests in certain outcomes and will use their powers (often backed up by considerable wealth) to influence the policy process. The most prominent example is lobbying by the private sector, but any other policy actor may be serving a personal interest in the outcome and use their power or authority accordingly.

Because of the above, policymakers rarely get the chance to go through the stages of [Figure 4.4](#) in an orderly fashion. They can be thought of as facilitators in a more complex process that ultimately results in policy change. In this role, they pursue at least the following objectives.

- Ensuring that the decision-making process is acceptable to the people that are affected (the stakeholders). For example, different voices must be heard, and the final decision must be supported by at least a majority.
- Creating workable and effective decisions, mostly through their policy expertise and the involvement of subject experts. For example, they may request expert evidence from academics, seek support from consultancies or conduct in-house research.

The next three sections elaborate how the five challenges shape the various stages of the policy process (problem definition, policy design, and implementation and evaluation), using examples and case studies from solid waste policy.



### 4.5.2 Defining the problem

Policy problems are not out there to be collected and solved. Instead, they are created by aligning facts and values regarding a situation. For example, over time, it has become clear that hazardous waste is linked to health, and agreement has been reached over the undesirability of such impacts (see [Box 4.3](#)). Defining problems starts with agenda-setting – the process by which problems become worthy of consideration by policymakers. The media plays an important role in this and activists often direct their energy at getting issues into the news. Because of the limited time and attention span of governments, problem definition is a competitive process in which various groups argue for ‘their’ problem to be moved up the political agenda.

Policy problems can be defined along several dimensions, which are represented by the following questions (adapted from Rochefort and Cobb 1993):

- What is the cause of the problem? Is there a single cause or multiple complex causation? Is the problem caused deliberately or accidentally? Who is to blame, if anyone at all?
- What is the nature of the problem? Is it severe; where and how much does it occur; is it increasing; is it new; is it an individual or societal problem? Is it an emergency?
- Who are the people that are affected? How are they affected? Are they worthy of attention and deserving of a policy solution? Is it a marginal and vulnerable group?

You can apply the above questions to any policy issue. The answers will provide you with a first description of the problem at hand.

Problem definitions tend to anticipate problem solutions and can, in practice, focus more on policies than desired policy outcomes. For example, the discussion around a carbon tax has, in some ways, divorced the policy from the problem (‘climate change’) and elevated its potential implementation to a problem in itself. Problem definitions can also cover the nature of the solution: whether the solution is available or nonexistent, acceptable or objectionable, and affordable or not. Explicitly or implicitly, problem definitions can naturally invite certain solutions, reflecting the preferences of the stakeholders who produced the definitions (see [Box 4.8](#)).

### BOX 4.8 COMPETING 'FRAMES' IN DEFINING POLICY PROBLEMS

When Finland joined the EU in 1994, its MSW landfill rates were still very high. The transposition of EU waste legislation in Finnish law introduced ambitious waste management goals, including a recovery target of 70 per cent by 2005. Three options were available to achieve the target: waste prevention, recycling and incineration. While the role of recycling was largely agreed, the stakeholders held very different views on incineration and prevention.

The environmental non-governmental organisations (ENGOS) 'framed' the situation as a problem of natural resource conservation and considered waste prevention the only logical response. They described incineration as 'an out-of-sight - out-of-mind strategy which doesn't tackle the real problems that are elsewhere' (Saarikoski 2006).

The municipal waste management sector (MWMS) 'framed' the situation as a problem of waste treatment capacity, arguing that incineration constitutes a pragmatic solution to the waste problem. It held prevention to be a lofty but unrealistic ambition and said that if 'waste can be used efficiently as fuel, then it isn't a problem if waste is produced' (Saarikoski 2006).

The 'framing' of problems refers to the use of storylines that emphasise certain causes and logical courses of action. Once a problem is framed, it becomes very difficult to weigh arguments in favour of and against the problem solutions, because the problem frames imply a solution already. Frames are rooted in different beliefs about how the world works and whose views we should value most. They are therefore difficult to change.

The two frames in the Finnish waste debate have clear premises and conclusions. The ENGOS believe in a reduction of environmental impacts across the lifecycle and therefore emphasise waste prevention. The MWMS takes waste generation as a given and therefore argues for increased waste incineration to avoid landfill. The latter viewpoint conveniently coincided with potential profits from increased waste incineration.

How to avoid the pitfall of framing? Framing experts recommend highlighting and discussing the different frames to help stakeholders gradually adjust their convictions and come to an agreement. However, in the Finnish debate, this only led to further polarisation. The two groups even disagreed over whether it is desirable to 'produce more from less'; the ENGOS questioned that we need 'more', whereas industry disagreed that a reduction of material use should be a goal in itself.



Re-focusing the debate on specific questions, such as specific waste reduction efforts, proved useful to avoid framing and encourage constructive comment. The process also needed a greater level of trust among the stakeholders; for example, the ENGOs saw the MWMS as short-sighted, 'traditional waste management folks'. In summary, the organisation and facilitation of the policy dialogue is essential for achieving the level of agreement required to take action.

Source: Saarikoski (2006).

### 4.5.3 Policy design

In the stylised model of policy change, the problem definition is followed by policy design. Section 4.4 already discussed the main types of policy instruments that can be part of a policy solution. The current section focuses on the reasons why an instrument or a combination of instruments may or may not be successful. The following four criteria provide a starting point:

- *Feasibility* refers to the ability of the government and its bureaucracy to execute the policy. The policy must have enough public support to be politically feasible and the implementation should not exceed the bureaucratic capacity. For example, a tax on household waste can be politically infeasible if it is seen as an attack on people's liberties and may be bureaucratically infeasible if public servants lack the resources to prevent fly-tipping.
- *Effectiveness* refers to the extent to which the policy solves the problem. The expected effectiveness may be inferred from similar policies in different jurisdictions or from a fundamental understanding of the causes of the problem. For example, the effectiveness of a plastic bag ban can be inferred from the various bans that have already been introduced around the world, provided there is a solid (scientific) understanding of why and how these bans have or have not been successful in other contexts.
- *Legitimacy* refers to the fairness of the decision-making and the policy. A legitimate policy has been agreed in an acceptable way, for example, based on scientific evidence and through extensive consultation. It should also be fair in its implementation; the benefits should be greater than the costs, it should respect the rights of all stakeholders and it should allocate burdens according to established principles, such as the polluter-pays principle.

- *Legality* refers to the legal status of the policy in relation to other laws and regulations. A policy must be legal in that it does not conflict with other laws and principles, including the constitution or international treaties. For example, the US state of Minnesota has outlawed plastic bag bans for all its cities, rendering such policies illegal (see [Box 4.9](#)). Issues of legality may also arise when considering the implementation of the policy, such as monitoring and data usage in relation to privacy.

The above are only four broad categories of criteria for deciding on policy instruments. More detailed criteria were implied in the discussion of assessment methods in [Chapter 3](#). For example, the discussion of LCA showed that effectiveness, in relation to addressing environmental problems, can be assessed for a range of environmental impact categories. Each impact category could be a criterion for choosing a certain policy design.

#### EXERCISE 4.2 CHOOSING POLICY INSTRUMENTS

Assume a wide interest in reducing retail plastic bags in your city. What policy instrument would you argue for? Make a table with four rows for the four types of policy instruments ([Section 4.4](#)) and four columns for the four criteria in this section. Fill out the table by specifying the challenges you expect for each policy instrument regarding each criterion. Considering the completed table, what policy instrument would you recommend the local government to pursue? What additional information would you need to make a better judgement?

#### BOX 4.9 DEVELOPING COUNTRIES AS POLICY LEADERS?

Developed countries tend to be the first to introduce stringent environmental regulations. They tend to have the technical knowledge, institutional capacity and concerned citizenry required to support environmental policymaking. However, when it comes to plastic bags, the reverse seems to be true; it is mostly countries in the Global South that have adopted plastic bag bans, whereas the Global North has favoured softer policy instruments.

Upon scrutiny, this pattern is not surprising after all, but exemplifies the conditions under which strict regulation can be introduced. First, the problem of



plastic bags is more urgent in countries that lack universal waste collection and treatment. To people in rich countries, plastics pollution is a global issue, but to many citizens in poor countries, plastic pollution is a daily sight in streets, parks and waterways and causes blockages in drains.

Second, most of the plastics industry is concentrated in Europe, the United States and China. In the United States, the plastics industry has poured millions of dollars into court cases to fight local governments adopting plastic bag bans. The lobby organisations emphasise industry jobs and the low embodied energy of plastic bags. Because of industry efforts, policies to tax or ban plastic bags have been prevented in various cases. The voice of the plastics industry is not as loud in developing countries.

Finally, in some cases, the industry providing substitute products plays a role. In Bangladesh, the jute industry has a long history and strong lobbying power, whereas the plastic bag industry is relatively new and not as well organised. In the past, jute was an important packaging material, and a ban on plastics could revive the industry. This coincidence of interests ultimately contributed to a complete national ban on plastic shopping bags in Bangladesh.

Source: Knoblauch, Mederake and Stein (2018); Clapp and Swanston (2009).

#### 4.5.4 Implementation and evaluation

When instruments have been chosen and specified, the policies can be implemented. However, given the challenges of problem definition and policy design, implementation is not at all straightforward either. For example, policies decided at the national level may not be successfully implemented at the local level. The following five challenges are common:

- *Coordination.* Many policies are decided at one level of government (e.g., national) but have to be implemented at a lower level of government (e.g., local). Since policy problems are not confined to the boundaries of these local jurisdictions, there is strong need for co-ordination between the lower governments.
- *Capacity and resources.* The executing government or agency must have sufficient capacity and resources to implement the policy, including skilled employees and sufficient budgets. Waste and environmental policy requires specialised skills that may be lacking in local and even national governments.

- *Knowledge and data.* The implementation of policy requires good knowledge and data regarding the current status of the problem. A lack of data can hamper the implementation of policy. For example, increased waste recovery is difficult to achieve in the absence of detailed spatially defined waste generation data.
- *Policy integration.* Waste problems are not isolated and waste policies therefore overlap with other policies for, among others, energy, transport and trade. Integration of these policies is required to effectively address the problem. For example, policies for waste incineration should be linked to energy sector policies.
- *Enforcement.* Effective policy implementation in part depends on monitoring and enforcement of the measures. For example, the implementation of emission limit values for incineration plants is unlikely to be successful unless the implementing agency can monitor emissions and punish offenders.

The fourth step in the policy process is the evaluation of the policy. At this stage, any deficiencies in the implementation should become apparent. It may also become clear that the initial problem definition or policy design was not fit for purpose. Such information should ideally feed into a renewed effort to define and address the problem. In practice, there is little to be gained politically from the evaluation of past policies, with few resources going to evaluation. Even when it is supported by government, policy evaluation is very challenging, not least because it requires isolating the impact of the policy from other factors that have affected the problem over time.

### EXERCISE 4.3 USING MFA AND LCA FOR POLICY EVALUATION

Many countries mandate separate collection of recyclables, which is more costly than mixed waste collection but leads to lower contamination of the recyclable fraction of waste. How would you use MFA and LCA ([Chapter 3](#)) to evaluate the effectiveness (i.e., whether the policy achieves its goals) of a separate collection policy? Discuss the following questions.

- What quantitative metrics could show the effectiveness of the policy?
- Which metrics can be estimated through MFA or LCA?
- What would be the goal, scope and system boundary of the analyses?
- What data would be required to conduct the analyses?

## 4.6 SUMMARY

Understanding waste policy and legislation is vital for understanding waste management because it is highly regulated. Historically, waste management efforts are driven by concerns over the resource value of waste, protection of human health and environmental protection. These concerns have arisen at different points in time but remain relevant in one form or another to this day. Most prominently, environmental concerns used to be local (e.g., air pollution) but increasingly include global concerns (e.g., climate change).

The definition and classification of waste are crucial for regulating waste generation and management. Generally, waste is defined as anything that is discarded, and exceptions are formulated for byproducts or wastes that have been recovered and are not waste anymore. Waste is classified into various categories for the purpose of regulating its management, for example, through permitting, most importantly by distinguishing between hazardous and nonhazardous waste.

Waste policy and legislation are built on key principles and requirements. The top priority tends to be waste prevention, as exemplified by the waste hierarchy. A precautionary approach is recommended in case evidence of impacts is limited. Many policies are built on the idea that it is efficient, effective and fair to make the polluter pay for the pollution they cause.

The main categories of policy instruments are regulatory, voluntary, information and economic instruments. Regulatory ‘hard’ instruments consist of legally binding measures. Voluntary ‘soft’ instruments are not legally binding but rely on voluntary commitments from the private sector. Information instruments are used to supply information (e.g., how to recycle) or collect information (e.g., on waste generation). Economic instruments achieve their goal by changing the price of goods and services, including through taxes and subsidies.

The policy process describes four stages of policymaking: problem definition, policy design, policy implementation and policy evaluation. In practice, the process is more complicated and muddled; it is a process in which many policy actors contribute, over long timescales, at different levels and scales, operating in different arenas for policy debate and sometimes driven by powerful interests. Within this complex process, policymakers play a key role as facilitators, ensuring that policies meet the criteria of feasibility, effectiveness, legitimacy and legality.

## **4.7 REVIEW**

---

- 1.** Explain how the drivers of waste management influence modern legislation.
- 2.** Identify the drivers of waste management in recent news articles about waste.
- 3.** Explain the key principles and requirements of modern waste legislation.
- 4.** List the main pieces of waste management legislation for your country.
- 5.** Explain the exceptions to the European definition of waste, such as byproducts.
- 6.** Look for examples of food processing byproducts sold to consumers.
- 7.** List key properties of the four main categories of policy instruments.
- 8.** Explain which policy instrument or instruments could help increase recycling.
- 9.** Explain why the stylised model of the policy process might be unrealistic.
- 10.** Explain why national recycling targets may not be achieved locally.





# 5

# WASTE PREVENTION

## LEARNING OBJECTIVES

After studying this chapter, you should be able to:

- discuss the concept and main forms of waste prevention and reuse
- describe how efficient production contributes to waste prevention
- explain how efficient use of products can prevent waste
- list the possibilities for waste prevention through product avoidance
- reflect on the main challenges for achieving waste prevention

## 5.1 INTRODUCTION

To avoid the challenges of waste management altogether, waste is ideally prevented instead of managed. Besides, a product that remains in use does not need replacements, which avoids the extraction, production and manufacturing of a new product. Waste prevention can therefore contribute to a reduction in impacts across the lifecycle and is an integral part of resource-efficient production and consumption. For these reasons, it is the highest priority in the waste hierarchy.

Waste prevention entails the reduction of the quantity of waste generated, or the reduction of the negative impacts of waste. Often, both are desirable. For example, lightweighting consumer products – making a lighter product through changes in the design – leads to a lower volume of end-of-life waste upon discarding the item. Besides, reducing the amount of potentially dangerous chemicals in the product, even if insignificant in terms of mass, reduces the human health and ecotoxicity hazards of the end-of-life waste.

As pointed out in [Chapter 1](#), waste prevention is distinct from waste management since there is no ‘waste’ to be managed. The responsibility for waste prevention is largely with producers and consumers and not with waste managers, since the latter deal mostly with material that is already waste. Prevention can be a difficult concept to work with, since it is essentially about something that is not there. The success of waste prevention is always relative to an assumed (and thus uncertain) scenario in which more waste had been produced.

Consistent with the waste hierarchy, this chapter precedes the chapters on waste collection and treatment, and the main waste management options. The chapter first looks into the concept and types of waste prevention and then focuses on three overarching strategies for waste prevention: efficient production, efficient use and product avoidance. The last section of the chapter describes the main challenges of waste prevention, some of which we will return to in [Chapter 9](#), which focuses on the concept of a circular economy.

## 5.2 OVERVIEW OF WASTE PREVENTION

### 5.2.1 The concept of prevention

Waste prevention is also called source reduction, waste minimisation, waste reduction and waste avoidance; all these terms essentially mean generating less waste. But less than what? Often, waste prevention means producing less waste than before – such as when municipalities try to reduce waste generation over time. It could also mean less waste per unit of product or service. For example, the amount of supply chain food waste could be reduced per calorie consumed, and a paper mill could try to reduce the amount of waste per tonne of final product.

Waste prevention includes the prevention of harmful impacts of waste by managing the quality of the waste that is generated. Qualitative waste prevention focuses on reducing the amount of hazardous waste or the hazardous contents of the waste. For example, waste prevention efforts in the European Union have led to a ban on the use of selected heavy metals (lead, mercury, cadmium and hexavalent chromium) and certain flame retardants (polybrominated biphenyls (PBB) and polybrominated diphenyl ethers (PBDE)) in electrical and electronic equipment (EC 2011).

Waste prevention can occur at any stage of the lifecycle: production, manufacturing, use and waste management. Often, decisions at an earlier stage in the lifecycle can reduce waste at a later stage in the lifecycle. For example, delivering building materials according to practical specifications can reduce waste generation at a construction site from cutting materials to size. Decisions regarding waste prevention may be taken as early as in the design stage, where crucial aspects such as lifespan, reusability and reparability are shaped.

### 5.2.2 Why products become waste

To understand how waste can be prevented, it is useful to think about why waste is created in the first place. The following root causes explain why a product may become unwanted and thus waste (Cooper et al. 2014).

- The product may become degraded due to wear, fatigue and accidental damage. For example, a toaster may need repair or maintenance, which is often more expensive than replacement. Other types of products may have been spent (e.g., a catalyst) or exceeded their shelf life (e.g., foods).
- The product could become inferior because a newer product offers better functionality. A newer product may also feature lower costs of use (e.g., maintenance costs) or the technology may have been superseded (e.g., electric cars superseding fossil-fuel cars).

- The product may become unsuitable due to a change in circumstances, preferences or legislation. For example, clothes are discarded when children grow and need larger sizes or when fashion changes. Legislation can make products less attractive, for example, when energy taxes make it uneconomical to use older, less efficient equipment.
- The product may become worthless when legislation prohibits its use, such as for lead paint. When the environment changes more broadly, even buildings can become waste; for example, the shift of industrial activity from the West to China has left behind derelict factory buildings.

The above root causes for waste generation are most useful for explaining the generation of waste from end-of-life products (as opposed to, say, factory production residues). Once the root cause of waste has been identified, prevention consists of addressing this cause (or the multiple causes).

The root causes show that products become waste partly because of their inherent properties and partly because of their context. For example, a car becomes degraded as a result of the (lack of) sturdiness of the design and the quality of the materials, but also because of the way it is used, the quality of the roads and the impacts of the weather. Waste prevention should focus on both the product and the use context; having an easily repairable car is useful only if there are sufficient repair workshops with skilled employees, as well as the appropriate tools and spare parts.

### EXERCISE 5.1 ADDRESSING CAUSES OF WASTE

Products become waste when they become degraded, inferior, unsuitable or worthless. Explain each of these causes of waste using the example of a smartphone. Next, explain which causes can be addressed with the following product-oriented strategies (i.e., changes in the product design): adaptability, reparability, flexibility of use, mobility, durability, upgradability and modularity. For the improved design to effectively reduce waste, how might the behaviour of consumers need to change?

#### 5.2.3 The economics of waste

From an economic standpoint, it may seem illogical that industrial societies generate so much waste. After all, is it not more efficient to use materials for as long as possible, and to avoid the cost of waste treatment and disposal?

Several factors explain the economics of waste. Foremost, the cost of disposal is often low, making it more attractive to buy new instead of reusing the old. Moreover, a new product may save money in other ways, such as through lower maintenance or energy use, rendering it overall less costly. But there are other reasons why sometimes, despite waste being costly, it still occurs. In economics, such situations are called market failures: instances where inefficient behaviour is stimulated by the particular market context.

- *Unpriced externalities.* The cost of waste generation and management may not be reflected in prices – it is ‘external’ to the producer. For a long time, it was very cheap to landfill waste, despite the environmental impacts. When the price of landfill does not reflect its environmental cost, it is used excessively.
- *Lack of knowledge.* People may not know how to save money by being less wasteful. For example, managers may not be familiar with waste prevention technologies for the production facility. They may be too busy trying to save money in other ways instead.
- *Misaligned incentives.* A waste prevention behaviour by one person may only benefit someone else. For example, if a household generates less waste, it can reduce disposal costs for the waste collector but not for itself, unless it pays per unit of waste that is being collected.

The above are simple examples of how markets may function in unexpected ways. Often, waste prevention is further complicated by the complexity of supply chains, the many interactions between buyers and sellers, and the particular properties of a product, a sector or a group of consumers. [Box 5.1](#) gives examples for the case of food waste in supermarkets.

### BOX 5.1 WHY A FOOD SELLER MAY WANT TO WASTE FOOD

Waste prevention seems like a no-brainer for businesses that sell food, such as supermarkets, bakeries and grocery stores. Any food that is wasted could have been sold instead! Or not? Tristram Stuart, a writer and activist, did extensive research on food waste. In his book *Waste: Uncovering the Global Food Scandal*, he explains how supermarkets and other sellers sometimes stand to gain from food waste.



Supermarkets sell more when they can present well-stocked shelves that offer a wide choice of products. The same is true for bakeries and other food sellers who put their wares on display. The downside of such well-stocked shelves is that some goods may never be sold. However, the opportunity cost of not selling is the sales price of the product, whereas the cost of waste is only the purchase cost, which is much lower. In other words, it might be advantageous to stock two products and sell at least one when the wholesale price is only half the retail price. In this case, the seller earns at least some money to pay for the costs of keeping the shop open (which requires energy use, wages etc.).

To address this form of waste, both buyers and sellers need to adjust how they operate. Customers might need to adjust their expectations in terms of daily availability of different products. At the same time, business could try other ways of drawing customers, for example, by showing how little food they waste!

Source: Stuart (2009).

### 5.2.4 Types of prevention

The next three sections of this chapter focus on three overarching types of prevention: efficient production and manufacturing, efficient use and product avoidance. These three types of prevention are subdivided into ten activities, ranging from lightweighting products to altogether avoiding the need for the functionality or service they provide. The types of prevention and activities are summarised in [Table 5.1](#) and illustrated with examples related to car use (if you were to compare all options in an LCA, you could define this activity more precisely as a functional unit; see [Section 3.3.2](#). For now, we simply speak of ‘car use’).

**Table 5.1** Examples of waste prevention related to car use.

Type of prevention	Activities	Examples for car use
Efficient production and manufacturing	Lightweighting	An improved car design requires less steel and therefore less iron ore. It reduces production waste and end-of-life waste.
	Material substitution	Substituting plastic parts that contain hazardous elements with clean alternatives reduces chemicals exposure throughout the lifecycle.
	Yield improvement	Manufacturing with efficient technology increases useful outputs over inputs (the yield) and reduces production residues.



**Table 5.1 (Cont.)**

Type of prevention	Activities	Examples for car use
Efficient production and manufacturing	Cleaner production	Shifting to production processes that require less chemicals leads to lower levels of hazardous and contaminated waste.
	Internal recycling	Using production residues again inside the factory minimises total inputs and reduces the amount of waste leaving the facility.
Efficient use	Extending lifespan	Designing a car that can be used for longer means that fewer cars are needed to provide the same level of functionality.
	Intensifying use	Ridesharing and carpooling can reduce the number of cars needed, and the associated material inputs and waste outputs.
	Reusing products	Using cars or car components again after the first user no longer wants them reduces the need for new production.
Product avoidance	Product substitution	Public transport makes car use redundant and involves much less material use and waste generation per traveller.
	Service demand reduction	City planning can bring work and residential areas closer, reducing the need for commuting, either by car or by public transport.

## 5.3 EFFICIENT PRODUCTION AND MANUFACTURING

### 5.3.1 Lightweighting

Efficient production starts with using less material per product, which can reduce material inputs, production waste and end-of-life waste. This strategy is called lightweighting. Lightweighting not only helps the environment but often improves product functionality; many movable products are ideally as light as possible, such as portable devices (laptops, smartphones), clothing (especially sports gear) and transport equipment (bikes, cars, planes). Lightweighting can also save material costs, but this has a significant impact only for products with high material costs; in practice, production costs are often dominated by labour and energy costs.



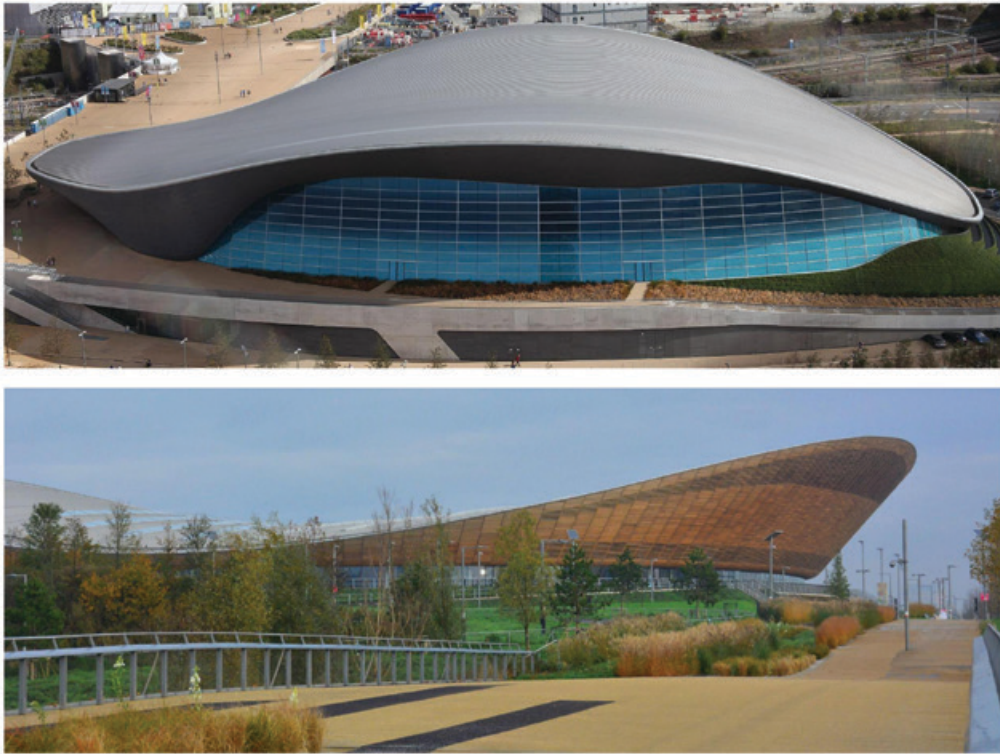

**Figure 5.1 Two roof structures in the Queen Elizabeth Olympic Park.** Top image: Rick Ligthelm; bottom image: Martin Pettitt.

Lightweighting rarely increases the performance of immobile products, but it does lower their environmental impacts. [Figure 5.1](#) shows two large structures in the Queen Elizabeth Olympic Park. The top one is the Aquatics Centre, with two 50-metre pools, and the lower one is the velodrome, with a 250-metre cycling track. The buildings are of similar size but the Velodrome has a roof five times less heavy than that of the Aquatics Centre (Allwood et al. [2012](#)). This was achieved by using a lightweight net of cables to support the roof, instead of the beams required for the swelling roof of the Aquatics Centre. Here, lightweighting reduced steel demand and the building's carbon footprint.

### 5.3.2 Materials substitution

Instead of using less material per product, it is sometimes attractive to use different materials. Substitution between materials can lead to a qualitative shift

towards less harmful production waste and end-of-life waste, and potentially less production waste. For example, disposable food containers of aluminium, extruded polystyrene or polypropylene have very different impacts (Gallego-Schmid, Mendoza and Azapagic 2019). A polypropylene container that is reusable has yet different impacts, but this should be considered a form of ‘product substitution’ (Section 5.5.1). Box 5.2 reflects on the substitution of a particularly harmful material: lead paint.

### BOX 5.2 PHASING OUT LEAD-BASED PAINT

Lead is a harmful element that affects the body in various ways. It is associated with learning disabilities, antisocial behaviour, reduced fertility, chronic kidney disease and cardiovascular disease. Phasing out lead-based products is one of the priorities of the UN World Health Organization (WHO). As a result, lead in petrol, plumbing and solder (for food cans) has been greatly reduced around the globe.

Unfortunately, lead-based paint remains widely available in some countries. Lead-based paint is harmful because painted walls and objects release dust and flakes over time, which are easily ingested, in particular by young children playing on the floor. Besides, the manufacturing, application and removal of lead-based paint constitutes a health hazard for workers.

Lead is used as a drying agent and pigment. Substitutes include strontium, zirconium and titanium dioxide. These substitutes need to be used in different quantities and potentially in combination with additional ingredients. At first glance, substituting lead is not technically difficult or expensive, which makes a ban on lead-based paints appear a viable option for reducing lead exposure.

In practice, it requires significant knowledge, skills and investment from manufacturers to change their products. The phase-out of lead therefore needs government action. The Global Alliance to Eliminate Lead Paint, a UN initiative, provides support for governments around the globe to introduce regulation for phasing out lead-based paint. In a September 2018 assessment, 71 countries had legally binding controls on the production, import and sale of lead paints.

The phase-out of lead-based paint faces a challenge common to many waste prevention efforts: substituting harmful materials with alternatives may introduce new environmental and health problems. Governments should not only phase out lead but also anticipate and monitor substitution patterns – what do manufacturers use instead, and how harmful are these new substances?

Source: (UNEP, n.d.).

### 5.3.3 Yield improvement

Yield loss reduction can reduce production waste and increase the amount of useful product created from a given amount of raw material. For any production process, the yield is defined as the mass ratio between the input and output; the difference between the input and the output is the yield loss (Equations 5.1 and 5.2).

$$\text{Yield} = \text{Output} / \text{Input} \quad \text{Equation 5.1}$$

$$\text{Yield loss} = \text{Input} - \text{Output} \quad \text{Equation 5.2}$$

Yield loss occurs during the transformation, cleaning, filtering, mixing and transport of materials. The loss may consist of dust, residues, rejects, cakes, ashes or any other type of material that is not an intended output from the process. For example, [Box 5.3](#) describes yield losses in the filtering and de-stoning of malt and the storage and transport of hops.

#### BOX 5.3 GETTING MORE BEER OUT OF MALT AND HOPS

The main ingredients for beer are malt, hops and water. Danish brewer Carlsberg wished to use these inputs as efficiently as possible at its brewery in Northampton, UK. A waste audit ([Section 1.5.3](#)) – as part of a voluntary commitment on reducing food waste – revealed that significant fractions of malt and hops were being wasted due to process inefficiencies. The prevention of this waste could reduce the cost of brewing significantly.

First, filtering and de-stoning of malt resulted in malt waste. The reject stream was sent for energy recovery, but it contained 95 per cent of useable product. Modification of the filtering and de-stoning process reduced this percentage and saved both materials and money. Besides, a new market was found for the malt rejects: they are now sold as animal feed instead of being burnt for energy recovery.

Second, an inefficient storage system led to hops waste. The hops were stored in standard 1,000 kg intermediate bulk containers (IBCs) with an outlet close to the bottom, connected to an automatic system for releasing the contents. However, 7 per cent of hops remained at the bottom upon emptying the IBCs. By installing a steel frame that allowed IBCs to be tilted, they could be drained much more effectively (see [Figure 5.2](#)).

Altogether, a waste audit and a few measures prevented a substantial amount of waste.



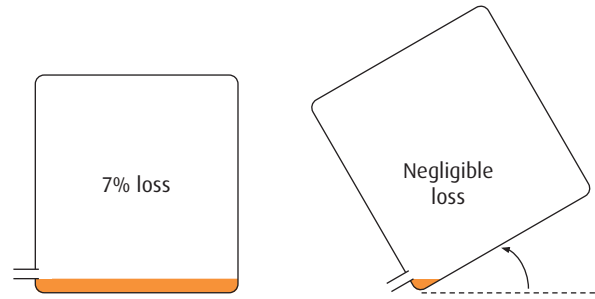

**Figure 5.2 A tilting container reduces production waste.** Image: Authors' own.

Source: WRAP, (n.d.).

### 5.3.4 Internal cycling

Internal cycling of material in a production or manufacturing facility, such as steel scrap cycling in steel mills, increases the overall efficiency of production; the steel mill will need less iron ore to produce its final products. Internal cycling can be beneficial when additional yield improvements are unattractive – instead of further reducing the yield losses, the losses are cycled back into the production line. Internal cycling is common for products that undergo various intermediate stages; for example, in steel production, yield losses may be cycled after casting, rolling, forming and fabrication of steel products.

#### BOX 5.4 THE ENVIRONMENTAL BENEFITS OF LEAN MANUFACTURING

In the 1930s, the Toyota Motor Company revolutionised car manufacturing. When the company moved from textiles into cars, its founder, Kiichiro Toyoda, analysed the problems at its engine-casting division and embarked on a programme of 'continuous improvement' to increase the efficiency of production. Engineers Taiichi Ohno and Shigeo Shingo further developed this approach into the Toyota Production System (TPS).

TPS and its derivatives are best known as 'lean manufacturing'. The goal of lean manufacturing is to provide the 'highest quality products and services, at the



lowest cost, with the shortest lead time' (EPA 2009). Lean manufacturing aims to eliminate various forms of waste from production facilities:

- overproduction (making too many items)
- excess inventory (too many materials in stock)
- defects (off-specification products that need repair or discarding)
- excess transportation (moving things around more than necessary)
- excess motion (more human effort than necessary)
- overprocessing (unnecessary processes)
- waiting (delays between processing steps)

Lean manufacturing is related to waste prevention and pollution control (a common term for waste prevention in businesses) but fundamentally geared towards cost reduction and competitiveness. Still, the lean manufacturing philosophy of continuous improvement and waste reduction, and the various tools for achieving this – such as multi-day events to identify improvement opportunities – could serve anyone pursuing waste prevention.

The US EPA recommends integrating lean manufacturing and environmental management. First, environmental management could borrow from the well-developed tool set of lean manufacturing. Second, lean approaches could be expanded to not only prioritise economically significant losses but also environmentally relevant waste.

In the list above, which types of waste do you think are most environmentally significant? How would you change or expand the list for environmental purposes?

Source: EPA (2009).

## 5.4 EFFICIENT USE

### 5.4.1 Product longevity

Product longevity describes the lifespan of a product from purchase to discarding. A product that is used for longer would still be discarded at some point, but postponing the end-of-life stage and the subsequent replacement reduces both waste generation and resource requirements. The longevity of a product is a function of its design (e.g., durability, reparability) and the way it is used, including whether maintenance and repair actually occur (which takes not only a repairable product, but also information, skills, tools and repair facilities).

To understand product lifespan, it is useful to think of a multitude of technical, economic and social lifespans. These lifespans can all be different. For example, a clothing item could technically function for multiple years but be out of fashion within a year. Its technical lifespan could be extended through repair but economically, it may be cheaper to simply buy a new product. Unfortunately, the shortest lifespan, not the longest, decides when the product is discarded (or just not used anymore, such as the clothing at the back of a wardrobe).

Product longevity can be expanded by, among others, addressing ‘planned obsolescence’: the deliberate design of products that need early replacement to boost product sales (Box 5.5). Producers, after all, can earn more by selling more products. The idea of planned obsolescence raises profound questions about production and consumption: can businesses thrive if consumers do not regularly replace products? Is there another way for businesses to keep growing? Or do we need to part with the idea of economic growth altogether? Chapter 9 will return to these questions.

### BOX 5.5 PLANNED OBSOLESCENCE

The dubious honour of the invention of planned obsolescence goes to the car industry. In the United States in the 1920s, sales had slumped, and the car industry needed a way to boost its figures. An article in the online publication Treehugger describes the history.

*Alfred P. Sloan, the CEO of General Motors, and his colleagues came up with a radical new idea that would change not only the auto industry, but the entire economy: planned obsolescence. GM would simply convince customers that one car in a lifetime wasn't enough. They'd have to keep buying new models to stay fashionable.*

*'You need to get people to want more things,' explained Gary Cross, a history professor at Pennsylvania State University who studies consumerism. Industry executives had to make people 'think about a car not just as a car, a transportation machine, but as an expression of your personality or your status or your desire for something new.'*



*'Sloan realized that they had to make people want things that they essentially didn't need,' said Jamie Kitman, a bureau chief at Automobile magazine. 'And that, along with the practice of consumer credit, which allowed people to buy things that they didn't need, was one of the big steps forward that just turbo-charged the industry for the next 75 years.'*

*The strategy worked, and those who didn't follow in Sloan's footsteps got burned. Henry Ford, for instance, hated the idea of planning for his cars to become obsolete.*

*'Henry Ford, a lot of his notions would today be viewed as insanity by people in the business of selling cars,' said Kitman. 'I mean he really had one model, he thought it was good enough. For many years it was truly only available in black, and he kept lowering the price.' By the end of the 20s, GM was bigger than Ford.*

Planned obsolescence is not exclusive to the car industry. Consider the products you have recently bought. How many of them were replacement purchases? Could an alternative design have lasted longer and made it unnecessary to buy more?

Source: Strauss (2022).

### 5.4.2 Intensity of use

Intensity of use can be increased by designing products that can benefit multiple users, provided user practices also change accordingly. Greater intensity of use leads to waste prevention because the number of products needed per person is lower. At the same time, it escapes the challenges associated with product longevity because products can still be replaced relatively quickly. Sharing can take many different forms. Consider transport; travellers can use cars more intensively through ridesharing, but also use roads more intensively by biking instead of driving (see also [Figure 5.3](#)).

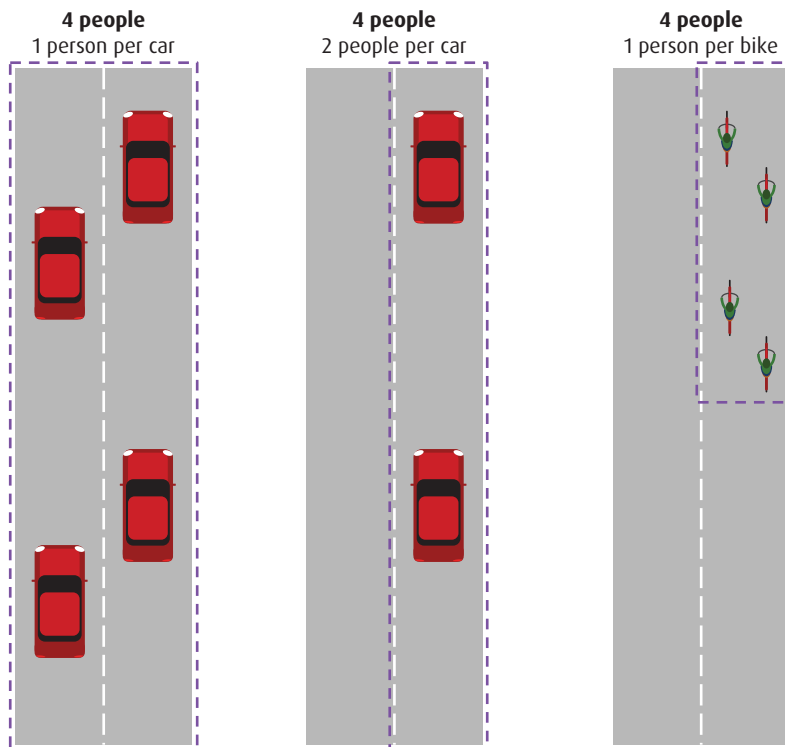

**Figure 5.3 Comparison of intensity of use of road space, assuming all travel at biking speed, with a 2-second distance between cars and a 1-second distance between bikes.**

Image: Authors' own.

Increased intensity of use is possible when a product has either multiple owners or is shared through a non-ownership model. In theory, sharing can bring very large benefits because many products are in use for only a few hours a day (cars), a few days a month (clothing), or a few hours a year (a cordless drill). However, users may need them at exactly the same time and, even if not, it can be very challenging to get the right products to the right people at the right time. Besides, not owning something can make people careless, illustrated by the phrase, 'Don't be gentle, it's a rental'.

Higher intensity of use can have various benefits besides reducing material extraction and waste generation. First, it can reduce the costs per unit of use and avoid the high up-front investment of product ownership (since it would be shared between users or shouldered by a business). Second, products that are used more intensively need faster replacement, which means users get access to more recent technologies. Third, for energy-consuming products, using the latest technology often implies lower energy consumption.



### 5.4.3 Product reuse

The third activity that contributes to efficient use of products is reuse. Product and component reuse entails transfer of ownership; rather than being used for longer, or more intensively, the product is used again by someone else, who becomes the new owner. The transfer of ownership makes reuse challenging; it must occur in a timely manner and through appropriate channels for exchange. The potential for reuse depends on the product design (its attractiveness over time), user practices (how we discard and purchase) and the exchange infrastructure (the availability of a marketplace).

For some products, reuse works very well. For example, there is a large market for second-hand cars, in part because car reuse meets the following conditions (in many countries, at least):

- For buyers, the product is expensive when bought new, and buying second-hand can save a buyer a significant amount of money.
- For sellers, the car has significant fixed costs (e.g., insurance) and residual value, and is too big to be left unused on the driveway.
- There are well-established practices for maintenance and repair, as well as government-mandated regular safety tests.
- There is a mature market for second-hand cars, with many car dealers selling and buying used cars alongside new ones.

Consider the reuse of smartphones, clothing items and cordless drills. Are any of the above conditions met? If they are not currently met, what could be done about it?

To wrap up the discussion of the efficient use of products, [Table 5.2](#) provides examples of all three activities for waste prevention in relation to laptops: increasing longevity through refurbishment, more intense use with multiple users and reuse of second-hand devices. All these activities already happen, but not very often; laptops are most commonly individually used, many older models are sitting unused in desk drawers and storage boxes, with few people interested in buying a laptop with yesterday's specifications. [Chapter 9](#) will discuss how this may change.

**Table 5.2 Increased longevity, higher intensity of use, and reuse.**

	Single user	Multiple users
Single-use life	E.g., individually used laptop	E.g., collectively used laptop, by a household
Multiple-use lives	E.g., individually used, refurbished laptop	E.g., collectively used, second-hand laptop

## 5.5 PRODUCT AVOIDANCE

### 5.5.1 Product substitution

Product substitution can address lifecycle impacts by shifting consumption to an altogether different product that fulfils the same need. For example, a reusable coffee cup could substitute a disposable coffee cup. Product substitution requires a good understanding of the needs that products fulfil. Consider the coffee cups again; does a reusable cup fulfil the same need as a disposable cup? Are they really substitutes?

- Both cups can hold a hot beverage, keep it warm, make it transportable and allow the user to drink it whenever they want.
- The disposable cup is more convenient; it comes with the coffee and can be disposed of in the coffee shop or almost anywhere else.
- The reusable cup has higher quality; it is more comfortable to drink from, insulates better, has nicer materials and features a design of choice.

The second and third point may seem trivial compared to the basic functionality described in the first point. But they matter; convenience is one of the main reasons people do not carry around reusable cups, straws, cutlery and lunchboxes. To convince people to carry reusable cups, the quality of the cups matters, as well as the environmentally conscious image. And it is the design of choice that helps convince many consumers to buy a reusable cup, brandishing their university, company or favourite sports team logo.

Product substitution constitutes a far-reaching change in production and consumption and has a variety of consequences. [Box 5.6](#) shows that substituting an old car with a new car can be both good and bad news for the environment. To assess how product substitution can reduce environmental impacts, a lifecycle perspective is essential. This, in turn, requires a good understanding of the functionality of the products, which has to be expressed in a functional unit for fair comparison between alternatives.

#### BOX 5.6 PRODUCT SUBSTITUTION: NEWER IS BETTER?

The material intensity of our activities is dependent on the technology we use. Generally speaking, newer technologies are more efficient than older technologies, and we therefore need less material per unit of functionality today than in the past. At the same time, technology has become more prevalent in our lives over



the past century and material use per capita has therefore increased. The effects are illustrated by one of the most widely sold cars on the planet.

- The first Volkswagen Golf was introduced in 1974. It weighed approximately 750 kg and had an average fuel efficiency of 8.5 l/km.
- In 2012, Volkswagen introduced the seventh generation of the Golf. It weighed approximately 1,100 kg and had a fuel efficiency of 4.9 l/km.

Both cars carry up to five people. Which car is more efficient?

The new car requires more metals and plastics but less fuel. In terms of material intensity, there is an upward trend for steel and plastics and a downward trend for fossil fuels. So, the question of which car is more efficient depends on the environmental priorities.

Technological development often has this dual nature; it reduces some environmental pressures but increases others. The increase often comes with an improvement in performance. The more recent Golf, after all, is more spacious, more powerful, faster, safer and more comfortable. To some extent, it cannot even be compared with the older car; it responds to quite different consumer needs and demands.

What about the most recent generation of Volkswagen Golf? How does it compare to the 2012 and 1974 models in terms of material intensity and energy efficiency?

### 5.5.2 Service demand reduction

The most radical path to waste prevention is to avoid consumption altogether by directly addressing the need it satisfies. Rather than driving environmentally friendly cars instead of polluting ones, demand for cars may be reduced by improving public transport or reducing the distance between home and work. Such measures work well together with some of the above waste prevention activities. For example, when people live closer to work, they do not need a car to commute, but they may still need a car to visit relatives; a car-sharing scheme could satisfy the reduced demand for car services.

The distinction between service demand reduction and product substitution is somewhat blurry. After all, a reduction in demand for one product will lead to an increase in demand for another; if we do not buy cars, we will spend the money on something else. [Chapter 9](#) will discuss this challenge of environmental 'rebound' in more detail. For now, it suffices to say that efforts towards substitution and

service demand reduction should consider whether, overall, consumption will shift from the most impactful activities towards more environmentally friendly products and services.

### BOX 5.7 SERVICE DEMAND REDUCTION: DID WE EVER NEED STRAWS?

Concerns over plastic pollution quickly turned public opinion against the disposable plastic straw. Straws were an obvious target because they washed up on beaches and hardly seemed to fulfil a critical need. Around the world, government or corporate bans on straws found widespread support and were enacted in many places. Not all these bans were comprehensive; some only demanded that businesses serve drinks without a straw but provide consumers with the possibility to get a straw if they want one.

A US study showed that changing the default to serving drinks without a straw can reduce straw consumption by 32 per cent if a self-service straw dispenser was made available, or by 41 per cent if straws needed to be asked for. The study also showed that the intervention hardly impacted business operation. Some businesses reported negative feedback, but some also reported a minor decrease in costs. Only a small fraction of businesses supplied non-plastic straws (such as bamboo or steel) as an alternative, which could offset such a cost saving.

To further reduce straw consumption, more stringent measures than default-choice architecture are required. An outright ban, as many activists argued for, could reduce the use of plastic straws to zero. However, the straw is not always a superfluous luxury; for customers with a disability, it can be an essential means to enjoy a beverage. And many of the alternatives – steel, bamboo, pasta – do not provide the same benefits as disposable plastic straws; they may be less hygienic, safe or convenient, and they tend to be more expensive.

An outright ban on straws should, therefore, include exemptions that ensure straws can be provided where needed. Still, the phase-out of the plastic straw stands out as a relatively easy one because most consumers can simply forego the straw without needing an alternative. It may be much harder to phase out other disposables, such as coffee cups, because their functionality is essential to every single customer.

Source: Jenks and Obringer (2020); Wagner and Toews (2018).

## 5.6 ACHIEVING PREVENTION

### 5.6.1 The role of product design

The design of a product decides how much and what kind of production and end-of-life waste will be generated. Table 5.3 lists the principles of green engineering (Anastas and Zimmerman 2003), which inform design to achieve waste prevention. The principles overlap with the waste prevention activities listed in the previous sections but provide a concise overview of specific actions that an engineer or designer may take. To better understand the principles, think about the kind of waste that may be prevented in each of the examples in the third column.

**Table 5.3 Principles of green engineering including examples.** Anastas and Zimmerman (2003).

#	Principle	Example
1	Designers need to strive to ensure that all material and energy inputs and outputs are as inherently nonhazardous as possible.	A consumer product is made without additives that could pose a threat to people's health during use or disposal of the product.
2	It is better to prevent waste than to treat or clean up waste after it is formed.	A factory increases the material efficiency of metal components manufacturing instead of recycling the waste from inefficient production.
3	Separation and purification operations should be designed to minimise energy consumption and materials use.	A recycling centre invests in energy-efficient technologies to reduce the energy demand of waste sorting and separation.
4	Products, processes and systems should be designed to maximise mass, energy, space and time efficiency.	The design of an office building is optimised to reduce material and energy use, minimise the physical footprint and maximise lifespan.
5	Products, processes and systems should be 'output pulled' rather than 'input pushed' through the use of energy and materials.	The output of a steel plant is driven by the demand for cars and building frames, not the abundance of coal and iron ore.
6	Embedded entropy and complexity must be viewed as an investment when making design choices on recycling, reuse or beneficial disposition.	A food waste reduction campaign focuses on meat because meat production tends to require more land, energy and materials than the production of almost any other food.
7	Targeted durability, not immortality, should be a design goal.	A coffee cup is made to be sufficiently durable to be reused, but upon disposal does not leave behind persistent microplastics.
8	Design for unnecessary capacity or capability (e.g., 'one size fits all') solutions should be considered a flaw.	A construction company uses beams that are just strong enough for their purpose, instead of heavier standardised beams.
9	Material diversity in multicomponent products should be minimised to promote disassembly and value retention.	The bucket and lid of yoghurt packaging are made of the same plastic to increase the chance of correct recycling by consumers.



**Table 5.3 (Cont.)**

#	Principle	Example
10	Design of products, processes and systems must include integration and interconnectivity with available energy and materials flows.	Trees are pulped in a paper mill; the cellulose is used to make paper, while the remaining lignin is burnt to supply energy for the pulping process.
11	Products, processes and systems should be designed for performance in a commercial 'afterlife'.	A vacuum cleaner with replaceable parts is repaired by replacing a fan, button or tube instead of replacing the whole product.
12	Material and energy inputs should be renewable rather than depleting.	Constructing homes from sustainably harvested timber conserves mineral resources used for making steel, cement or bricks.

The principles of green engineering show that it is possible to reduce waste throughout the lifecycle by making smart design decisions. Conversely, ill-informed past design choices leave current consumption 'locked' in to wasteful patterns. For example, we all buy products that persist in the environment long after their useful life, such as disposable plastic cutlery and plastic bags. The principles should not be seen as an optional consideration to improve product design; they should fundamentally inform product design, in the same way that safety, ergonomics and costs inform the design of products.

### 5.6.2 Waste prevention policies

This chapter shows that waste prevention covers a great variety of activities, ranging from lightweighting of products to reducing demand for the services delivered by products. For example, we can reduce waste from transport by designing lightweight cars, which leads to a better fuel economy and a smaller volume of end-of-life waste, but also through improved city planning, which reduces the demand for commuting by car. With so many forms of prevention, there is also a great number of potential waste prevention policies.

In practice, when people talk about waste prevention policy, they often refer to policies focused on discouraging waste generation and promoting better waste separation. For example, pay-as-you-throw (PAYT) taxes charge waste generators, such as households, based on the amount and type of waste they discard. The charges may be lower, or even absent, for recyclable waste. The intended effect of such a policy is to lower waste generation volumes and to increase the fraction of waste that is correctly sorted as recyclable.

However, changing the cost of waste generation is only one of many policy options for waste prevention, and rarely the most effective. [Exercise 5.2](#) invites you to explore the options, based on the example of cars and commuting ([Table 5.1](#))

and the information on policy instruments from [Chapter 4](#). The exercise shows that waste prevention not only takes many forms but can be promoted through many different policies. The [next section](#) describes a particularly relevant policy approach that is not covered in the exercise, focusing on design.

### EXERCISE 5.2 WASTE PREVENTION POLICIES

Waste prevention ranges from designing better products to improved city planning. [Table 5.1](#) gives examples of each type of prevention related to cars and commuting by car. Can you think of policies that stimulate each of the waste prevention activities? Would you use regulatory, voluntary, information or economic policy instruments (see [Section 4.4](#) on policy instruments)? Make a table with waste prevention activities as rows and the types of policy instruments as columns; try to give at least one example of a policy for each cell (there should be 36 cells to cover the 9 prevention activities and 4 policy instruments).

### 5.6.3 Extended producer responsibility

Better product design is a powerful method for waste prevention. However, it is difficult to promote green design through public policy, since design is a complex, creative and specialist activity; no government is in a position to dictate the best design of any product. Extended producer responsibility (EPR) has the potential to resolve this challenge; it stimulates green design by making the producer responsible for the end-of-life phase of a product, and thereby the beneficiary of improvements in design.

EPR is not a policy but rather a policy approach, which can be realised by implementing various measures. Ideally, an EPR scheme would make producers directly responsible for the waste from their products, and the producers would also directly benefit when this waste is reduced through environmentally friendly design. A well-designed product would have lower end-of-life costs (e.g., because it is recyclable) and could therefore be sold at a lower price, leading to more market success than less environmentally friendly alternatives.

In practice, there are major challenges in allocating responsibility for waste management to producers, not least because their products end up in a mixed waste stream. Most EPR schemes therefore only allocate collective responsibility to a sector for its waste. For example, all electronics manufacturers in a country will pay a central organisation to take care of the waste from their products. The individual contributions are proportional to market share and a central organisation uses the funds to support electronics waste collection and treatment.

Such a collective scheme successfully generates funds for waste management but rarely incentivises green design. After all, whether an individual producer's product is green or not, the charges will have to be paid. This is why some EPR schemes have differentiated fees, with manufacturers paying less when their products are recyclable or more durable. The producers can save money by designing products that incur smaller charges. A potential limitation of fee differentiation is that it focuses on well-known product features rather than stimulating more innovative approaches to environmental impact reduction.

### BOX 5.8 AN EPR SCHEME FOR TEXTILES IN FRANCE

While EPR schemes rarely achieve green design, they can serve many other purposes. The French EPR scheme for textiles combines social and environmental policy objectives; it supports employment in a struggling sector, helps people to find jobs who face difficulties in the labour market and increases separate collection and recovery. The scheme could potentially stimulate green design once various improvements have been made to the policies.

In the scheme, a single producer responsibility organisation (PRO) charges producers for putting textiles on the French market. For every item, producers pay up to 5 eurocents, depending on the item size. The PRO distributes the funds to 64 textile sorting centres that receive textile waste from collection points in 670 communities, covering 86 per cent of the population. Some of the funds are used to support research and development projects into improved textile separation and preparation techniques.

Thanks to the EPR scheme, the nationwide separate collection of textiles rose from 76 kilotons (kt) in 2007 to 184 kt in 2016. The vast majority of these textiles are reused, unravelled into reusable fibres or turned into wiping cloths. Less than a tenth of the mass of the textiles is disposed of (incineration or landfill). The sorting centres together support 1,400 jobs, with about half of the positions held by people facing employment difficulties.

So far, reuse of the textiles has consisted mostly of exports to developing countries, which is problematic. The receiving countries increasingly bar the imports because the goods distort local markets for textiles. Besides, there is competition between French imports, cheap textiles from China and used clothing from countries other than France. To lessen its dependence on exports, France has to increase reuse domestically, which is a major challenge.





The PRO has discounted fees for products with high recycled content. However, very few producers have made use of this because the savings are not sufficient to cover the additional administrative costs of evidencing recycled content, let alone the cost of changing product designs. An improved fee structure, with discounts for durability, has now been introduced. Time will tell how well this works.

A potential improvement to the scheme would be an exemption for producers that take back their own textiles. For this to work, the fees would have to be high enough to make a take-back scheme cost-competitive. Take-back schemes would give producers much more control over the reuse and recovery of their products. Most importantly, producers would be able to benefit directly from innovative green design solutions.

Source: Bukhari, Carrasco-Gallego and Ponce-Cueto (2018); Eco TLC (2016); Domenech et al. (2019).

## 5.7 SUMMARY

Waste prevention consists of reducing the quantity of waste as well as the harmfulness of the waste that is generated. Waste prevention could target waste from any stage of the product lifecycle and may address any of the causes of waste generation, which include materials or products becoming degraded, inferior, unsuitable or worthless. Waste prevention may be explained in economic terms through the inefficient functioning of markets, including unpriced externalities, a lack of knowledge of waste prevention activities and misalignment between the people that could invest in waste prevention and the people that would reap the benefits.

Waste prevention activities can be categorised into efficient production, efficient product use and product avoidance. Efficient production refers to lightweight design, material substitution, yield loss reduction and internal cycling. Efficient use entails maximising the number of users and use lives of products and focuses on product longevity, intensity of use and product reuse. Product avoidance entails using an entirely different product to fulfil a service or to not even demand the service in the first place. Product avoidance tends to have the largest impacts on waste generation but requires a major shift in business activity and consumer behaviour.

Product design plays a major role in waste prevention because it affects how a product is made and how it can be used, and whether the end-of-life waste can be successfully recovered. Since waste prevention ranges from lightweighting to service demand reduction, there is a large variety of policy measures that can promote prevention. To achieve prevention, it should be considered in virtually every policy field, from product regulation to city planning. Among the policy approaches is extended producer responsibility, which can stimulate green design by making producers responsible for the waste from their products.

## **5.8 REVIEW**

- 1.** Explain the differences between waste prevention and waste management.
- 2.** Provide examples for each of the major causes of waste generation.
- 3.** Explain how efficient production and manufacturing can reduce waste.
- 4.** Describe the difference between internal cycling and recycling.
- 5.** List the major strategies for increasing the efficiency of product use.
- 6.** Provide example strategies for the more efficient use of buildings.
- 7.** Explain how product avoidance can contribute to waste prevention.
- 8.** Identify which forms of service demand reduction can address food waste.
- 9.** Provide examples for each of the principles of green engineering.
- 10.** Describe how an EPR scheme for laptops might work in practice.



# 6

# COLLECTION AND TREATMENT

## LEARNING OBJECTIVES

After studying this chapter, you should be able to:

- describe waste collection infrastructure and practices
- explain the purpose and concept of waste treatment
- name physical, physicochemical, biological and thermal treatments
- describe the technological basis of widely applied treatments
- discuss the main environmental impacts of treatment technologies

## 6.1 INTRODUCTION

When waste cannot be prevented or reused, it must be collected for management according to the priorities of the waste hierarchy: first recycling, then other types of recovery, with disposal only as a last resort (Section 1.5.2). Well-designed and correctly operated collection systems enable subsequent recovery of the waste, whereas poor collection practices may doom the waste to landfill. Even with the best collection practices, though, additional processing (treatment) is usually needed to make the most of the collected resources and avoid damaging impacts on the environment. Effective separation of desirable materials is essential to recovery, and removal or treatment of undesirable contaminants and pollutants is necessary for both recovery and landfill.

Most people are familiar only with the waste infrastructure they see at home. Householders place their waste bins on the curb in front of their homes, or in the designated collection area of their residential block, and garbage trucks (or ‘dustcarts’) come and pick them up. But household waste is only a small proportion of overall waste (Section 1.4.1), and household bins and collection vehicles are only a small part of the overall waste management system. Few people know what happens to household waste once it leaves their home, and even less about what happens to other types of waste. This chapter explains the principles and use of the typical systems for the collection and treatment of household waste, as well as extraction and manufacturing waste.

This chapter begins by explaining how modern waste collection systems developed, and continue to evolve, for household and industrial waste. The chapter then introduces physical, physicochemical, biological and thermal treatment processes in the context of waste treatment facilities. The subsequent sections explain the treatments in more detail based on their operating principles and purposes.

## 6.2 WASTE COLLECTION

### 6.2.1 Collection infrastructure

Waste collection has been necessary ever since population density and affluence increased to the point that households and businesses were no longer able to manage their waste on their own properties. For millennia, businesses around the world have collected unwanted materials and items to make a profit from their recovery (Figure 6.1). There have also long been businesses that offer collection of waste for disposal on a fee-for-service basis, which started with individuals taking a cart with waste to the edge of town. As the amount of waste has grown, so have waste collection businesses. In 2020, the five largest fleets of garbage trucks in the United States comprised more than 80,000 vehicles; the world's largest waste management company employed about 90,000 people globally.



**Figure 6.1** 'Changing rags for something sweet'. A display in the Shanghai Urban Planning Exhibition Center shows mothers exchanging rags for pieces of malt sugar cake in Shanghai in the early twentieth century. Image: He Youzhi (贺友直).

Numerous complaints about litter and waste in streets are on record from Roman and medieval times, with patchy government intervention. In England in 1388, following complaints about waste, the Statute of Cambridge required ‘dung, garbage, entrails, and other ordure in ditches, rivers, waters and other places ... utterly to be removed’, and ‘none ... to be cast or thrown henceforth’. Compliance with this law seems to have been limited, maybe because there was no clear alternative. When complaints continued, the 1875 UK Public Health Act made local governments responsible for the removal of rubbish. Similar measures were enacted around the world, and it is now common for local governments, usually municipalities, to manage household waste collection services.

In many places, household waste is collected weekly from individual households, and the collection is paid for by municipal taxes. With the implementation of collection for recycling, different waste fractions may be collected in alternate weeks. Municipalities also manage other wastes associated with towns and cities, such as bulk wastes (mattresses, appliances), street sweepings and park wastes. In most cases, municipal solid waste (MSW) and household waste have a similar composition, and the terms are often used interchangeably. In practice, they are not always the same. For example, some regions include small-scale construction and demolition waste, incinerator ashes and sewage treatment wastes in their MSW statistics and management plans. Commercial waste and industrial wastes are the responsibility of the enterprises that generate them, who either recover or treat them on-site or pay for waste management companies to do so.

### 6.2.2 Household waste collection

From pre-industrial times until fairly recently, waste in developed countries was collected in baskets and wooden barrels, or any handy receptacle, and still is in areas with less-developed infrastructure. In the nineteenth century and the first half of the twentieth century, household waste, especially in areas where home heating was needed, contained a large component of coal ash. It was collected in metal garbage cans to prevent the spread of fires caused by hot ash setting the other discarded materials alight.

Since the late 1960s, household waste in developed countries has been mainly composed of kitchen waste, paper and packaging. The waste not destined for recycling is typically collected in green or black polyethene garbage bags (‘bin liners’). Although these bags are robust enough to be sealed with a twist tie and placed at the curb for collection by the municipality, an external receptacle may be needed to protect against marauding animals (Figure 6.2).



**Figure 6.2** Animals are better at making the most of resources, including food discarded by humans in a variety of receptacles. Rat image: Mark D. Sheperdigian, 2018. Other images: Shutterstock.

The rise of recycling practices has reintroduced the need for bins. Garbage bags are difficult to process for recycling facilities because they need to be opened and constitute an additional waste stream that is hard to manage. Recycling schemes (Chapter 7) have arisen simultaneously in many different regions but often differ in what they collect and how they collect it. It has been difficult to come to a consensus about the combination of collection receptacles (e.g., a mixed recycling bin or separate bins for different recyclables) to be used because of local differences in, among others, the waste stream, household behaviour, the value of recyclables and historical investments.

Dry materials for recycling are commonly collected in 240-litre wheeled bins ('wheelie bins'), 55-litre plastic carry boxes and, sometimes still, plastic bags. Food waste is most often collected in relatively small (e.g., 20-litre) biodegradable bags, and garden waste in wheeled bins. The remaining residual waste may be collected from the curb in a wheeled bin, but most regions still require it to be enclosed in a plastic bag for tidy handling. Residual waste often contains physical and biological hazards, such as medical waste and sanitary items, which need to be handled carefully to keep workers safe.

Developments in electronic sensors and tracking systems have enabled the use of 'smart bins', which can report the amount and location of waste in real-time. Such information is useful for planning collection schedules and routes. It can also be used to support waste reduction by charging for waste collection



based on the amount generated. This practice is resisted by householders who consider such charges to be an increase in taxation. Also, it is difficult to be fair. For example, should a family with several young children have to pay more to dispose of their heavy nappies?



**Figure 6.3** Curbside domestic waste collection vehicles going about their business at different scales. Images: Julia Stegemann.

For most of history, waste was collected in open-top vehicles – first wagons, then trucks. The disadvantages included wind-blown debris and dust along the transport route, and the disgusting task of emptying such vehicles of smelly garbage at their destination. Tippable carts came into use over the past century. Successive inventions resulted in the most common household waste collection vehicle of today: a truck that automatically picks up wheeled bins using a side or rear fork and empties them into a large, fully enclosed container. Variations exist, depending on whether the household waste is completely mixed or has been separated into different fractions. In most cases, the rubbish is crushed and hydraulically compacted into the container, which is then hydraulically emptied when it reaches its destination. By compacting the waste, garbage trucks typically hold up to 20 tonnes.

Large collection vehicles are not suitable for all circumstances. For example, much smaller versions can be seen on the narrow streets of ancient European cities (Figure 6.3a and b). While garbage trucks were once powered by gasoline ('petrol') or diesel, efforts to decarbonise transportation have led to alternative fuels, such as liquid natural gas (including biogas; Section 8.4.4) and biodiesel, and even electric garbage trucks. As large, unwieldy vehicles with poor visibility of all but the road ahead, garbage trucks can be a danger to pedestrians and cyclists. To make an accident less likely, they are now equipped with sophisticated safety systems. In cities with a well-developed water transport network, such as Amsterdam, Suzhou or Venice, waste may also be collected from homes by boat. Another alternative is automated vacuum collection (AVAC; Box 6.1).

Commercial wastes from service-based industries, which are mainly from offices, contain similar materials as household wastes, though with differing proportions of food waste, packaging and end-of-life items. They are usually collected under private contracts, rather than by the municipality, but using similar waste collection systems.

### BOX 6.1 MAKING WASTE COLLECTION A BREEZE

Why does waste require overflowing bins and noisy trucks, when other utilities – electricity, gas and water – run invisibly underground? This is a question posed by the Swedish company Envac. In 1961, the company installed the world's first automated vacuum collection system (AVAC) for a hospital. In 1965, the company installed the first AVAC system for household waste in a suburb of the Swedish capital, Stockholm.



With AVAC, householders deposit their rubbish into hatches located in their own homes or in nearby public areas. The hatches may collect different waste fractions: food waste, recycling or residual waste. The AVAC system transports the deposited waste to a collection station through an underground pipeline, using suction created by industrial fans.

Thousands of these systems operate worldwide, in many different countries. However, the systems are relatively small and the fraction of global waste that is collected through AVAC remains negligible.

The major advantage of AVAC technology is the absence of bins and trucks. The tidy hatches occupy minimal space and truck traffic in cities is avoided. The reduction in traffic emissions from waste collection is about 90 per cent, which benefits both the climate and local air quality. Depending on the context, AVAC systems need not be more expensive than traditional collection systems; they require high investment but feature low operating costs. An analysis for the city of Athens, Greece suggests that AVAC costs are similar to those of conventional collection on an annualised basis. The high investment can nevertheless be a barrier to implementation.

New York City operates an AVAC system on Roosevelt Island. The island, a narrow strip of land in the East River running past Manhattan, has traffic connections with the rest of New York City but has remained relatively quiet and isolated. Thanks to the AVAC system, waste collection truck traffic is down by 80 per cent. Some trucks are still needed to transport full containers away from the island.

In 2013, a study looked into the possibilities for AVAC on Manhattan, which presents a very challenging context due to the extreme density of existing buildings and infrastructure. The study found the total cost of AVAC to be greater than for traditional waste collection. However, when the environmental benefits were monetised – more space and fewer emissions – they offset the additional economic cost.

Source: Nakou, Benardos and Kaliampakos (2014); Kamanga et al. (2013); Young (2020).

### 6.2.3 Source-separation of household waste

In most regions, community recycling began with the collection of out-of-date newspapers and clean container glass. These were usually collected at privately operated ‘drop-off’ or ‘bring’ sites. For example, householders could bring these materials to large bins in supermarket carparks when they did their shopping. The source-separated newspapers and container glass were valuable to recyclers because of the low level of contamination, which makes them a suitable feedstock

for manufacturing good-quality new products. However, source-separation cannot avoid contamination altogether.

- Most people are unlikely to wash the items they discard, so packaging is contaminated by whatever it has contained, including food and drink.
- Many products, including appliances and clothing, are composed of several materials. Since they are rarely designed for disassembly (Section 5.6), the component materials contaminate each other from the point of view of potential recovery.
- Even a seemingly ‘single’ fraction of recyclables, such as ‘paper’, actually includes various materials: high-quality printer paper, shiny magazine papers containing fillers, low-quality cardboard and also staples, ink and glues.

The compromise is to collect materials from households in groups and sort them further at a centralised facility. As the number and quantity of materials being collected for recovery have grown, local governments in developed countries have increasingly implemented curbside collection of materials that arise daily or weekly. This practice is more convenient for households than drop-off sites and it improves household participation rates. Drop-off sites are still used in areas with low population densities (Figure 6.4) and for certain material groups, such as textiles (Box 5.8), waste electrical and electronic equipment (WEEE) or household hazardous wastes not covered by curbside collection.



**Figure 6.4** Dubai desert ‘drop-off’ recycling collection – just emptied or underused?

Image: Julia Stegemann.

Material groups to be separated by household must be easily identifiable by individuals and easily sortable by automated processing facilities. With a larger variety of materials now being collected for recovery, the easiest separation for householders to accomplish is between ‘wet’ and ‘dry’ materials for recovery, and the nonrecoverable items that constitute ‘residual’ household waste. ‘Wet’ food and garden waste can be biodegraded to make products, for example, soil, uncontaminated by other materials. Meanwhile, ‘dry’ (‘commingled’ or ‘single-stream’) paper, plastic, glass and metal recyclables are further processed in MRFs, which separate materials based on their physical properties, using a series of mostly mechanical processes.

Each process in the MRF has a separation efficiency (a type of transfer coefficient; [Section 3.2.2](#)), which is lower for materials that are more difficult to separate. Even a good overall separation efficiency may be problematic, though, if it results in a level of contamination that is unacceptable to the users of the resulting material streams. For instance, glass and paper can be easily separated because the density of glass is much higher. Unfortunately, even a very small proportion of broken glass can damage papermaking equipment and affect product quality. Some community recycling schemes therefore pursue cleaner material feedstocks by collecting paper, plastic, glass and metal in different receptacles.

#### 6.2.4 Industrial waste collection

Waste from industrial sectors (agriculture, extractive industries, refining, manufacturing, construction and demolition, utilities; [Section 1.4.1](#)) differs considerably from household wastes and has great variety. It may be relatively inert in the environment or capable of causing serious pollution. It may be predominantly inorganic, including minerals and both valuable and toxic metals, or mainly organic, including easily degradable carbohydrates, recalcitrant hydrocarbons and toxic organic molecules – or it may contain mixtures of all of these. It may be in the form of liquids, pastes, slurries or solids, or it may contain volatile or reactive components. Even a single industry may produce very different wastes. For example, wastes from textile production include greasy sludges from wool washing, liquid spent-dye baths containing hazardous substances, and fluffy fibre waste containing natural and or synthetic (polymer) fibres.

Characterisation of the physical, chemical and biological properties of wastes using standardised methods is essential to planning their handling, collection, treatment and recovery or disposal. Consideration of hazardous characteristics ([Table 2.2](#)) is particularly important. A risk assessment, with an evaluation of the hazard, the associated risk of harm and the design and implementation of control measures, is necessary to avoid harm to humans or the environment



during on-site handling, transport and storage. Such information is generally recorded upon reception at each stage of the chain of custody (Section 4.3.3). Businesses use an environmental management system (EMS) to collect data in a format suitable for exchange with custody transfer or provision to regulatory authorities.

**Table 6.1** Examples of waste handling equipment.

Type of equipment	Description
Excavator with bucket	A heavy hydraulic machine, usually with track propulsion, with a rotatable cab that operates a shovel. Excavators range in size from 1 to 1,000 t, with bucket capacities of up to 100 t.
Belt conveyer	A system of pulleys that move a looped belt for transporting materials on the upper surface of the belt.
Screw conveyor/pump	A rotating spiral blade within a tube for movement of granular materials, liquids or slurries.
Pneumatic conveyer	A system of pipes used to move free-flowing powdery materials using air pressure or suction. Since the system is sealed, dust emissions are avoided.
Corrosion-resistant peristaltic pump	A flexible tube holds the liquid or sludge, which is moved along by rollers. To prevent corrosion, the pumped fluid is not in contact with any mechanical parts.
Dumpster/skip	Waste collection containers ranging in size from 2 to 40 m <sup>3</sup> (alternatively defined in cubic yards) for use with specially designed trucks. Dumpsters can be picked up and emptied using hydraulically controlled steel forks. Skips have lower sloped ends and high sides. Two lugs on each side allow chains to be attached for loading onto a truck. Larger sizes of dumpsters and skips have wheels to roll them on or off a truck.
Front loader truck	Powered forks on the front of the truck are inserted into sleeves on a dumpster. The dumpster is then lifted over the truck and flipped upside-down to empty material into the truck's hopper. Front loaders can typically lift dumpsters of 4 t and hold about 40 m <sup>3</sup> . Other sizes are available.
Tanker truck	Cylindrical tank with a typical capacity of 10 to 40 m <sup>3</sup> . The tank is filled by connecting it to a pipe from the supply. The tanks can feature different types of materials or linings to avoid reaction with the contents and usually have compartments or baffles for balancing the load.
Flatbed truck	The load is placed on a flatbed, which may be articulated for greater capacity. Adaptations include ramps, curtains or other equipment for making loading easier or to fix the load.

Table 6.1 shows a small selection of the thousands of types of specialised containers, conveyance systems and transport systems that have been invented for handling different wastes, depending on their specific characteristics. A waste

audit, to record and analyse the quantities and types of waste generated, is essential for planning waste management (Section 1.5.3). As is the case for household waste, industrial wastes are usually easier to treat and/or recover if they are separated at the source. In accordance with the hierarchy, waste management may include process redesign for waste prevention (Section 5.3).

Alternatively, waste from different stages of the manufacturing process may be cycled back into the process from which it is generated without ever leaving the site (Section 5.3.4). In this case, the waste may instead be considered a 'byproduct' (Section 4.3.2). Contaminated soil that arises from spills, or as a legacy of previous careless waste management practices on industrial sites, may also be treated on-site. On-site waste management practices are usually subject to the same regulatory permitting as industrial facilities, and waste generation must be reported for both on-site and off-site management.

### EXERCISE 6.1 FINDING THE RIGHT TOOL FOR THE JOB

Table 6.2 shows some basic properties of a selection of industrial wastes, which affect their handling characteristics. Considering the list of handling equipment in Table 6.1, can you identify the most appropriate equipment to move each of these wastes? What additional information would be useful to make this decision? Is other equipment necessary that is not listed in Table 6.1?

**Table 6.2 Example characteristics of industrial wastes.**

Waste type	Physical state	Moisture content (% wet mass)	Particle size	pH
Acid mine drainage	Slurry	95	-	2-3
Electric arc furnace dust	Solid	<1	<30 µm	10-13
Plating bath neutralisation sludge	Sludge	65	-	9-10
End-of-life vehicles	Solid	-	~ 1 t	-
Concrete from demolition crushed on site	Solid	-	<6 × 10 <sup>-7</sup> to 0.5 m	10-12
Dewatered sewage sludge	Paste	60	-	6-8

## 6.3 WASTE TREATMENT

### 6.3.1 History and requirements

In the pre-historic past, the objects people used were made mainly of naturally occurring materials. Objects were maintained, traded and reused until they became unusable, and then left where they fell, burnt or discarded in a midden by each household. Treatment was not necessary because the quantities were small; organic materials biodegraded and mixed with ash and other mineral materials to renew the soil. Occasional small bonfires took care of any excess, but the impacts remained in proportion to the small quantities of materials used. As communities grew over time, it became common to dispose of unwanted materials on their outskirts, where they did not bother most people.

Industrialisation and rapid population growth have made the impacts of waste inescapable. Since the start of the industrial revolution, soil, ground and surface water and air have become polluted by dumping, which leads to actual and potential health effects on people (Box 4.3). The quantities of mining and metal processing wastes have grown and have been dumped in large quantities, including industrial wastes containing hazardous manmade chemicals. To prevent these impacts, waste must be treated, after which it may be converted to usable feedstocks. When waste is destined for landfill, it still needs treatment first. For example, the European Landfill Directive requires that all but inert wastes destined for landfill must undergo treatment to reduce their quantity or the hazards they pose to human health or the environment.

Wastes that are not treated but dumped in the environment undergo a variety of physical, chemical, biological and thermal transformations. The undesirable impacts result largely from a lack of control over how, when and where these natural processes occur. Industrial-scale waste treatment aims to meet legislative requirements by leveraging similar processes, but in a controlled manner. The big difference is that these processes are now engineered to occur where and when we want them to. They are more efficient and effective at separating valuable materials and removing or destroying contaminants and pollutants to control the impacts and risks to human health and the environment.

The selection of waste treatment processes is based on the idea that best available techniques (BAT) should be used to prevent pollution. BAT refers to the economically and technically feasible options that are the best overall for minimising emissions and environmental impacts. They can include the choice of equipment and the way a facility is designed, built, maintained, operated and



decommissioned. The use of BAT (or similar ideas, such as the best practicable means, the best practical environmental option, the best available techniques not entailing excessive costs and the best available technology etc.) is prescribed by legislation worldwide. For example, the EU has developed BAT reference documents for a range of major industries ([Box 6.2](#)).

### BOX 6.2 AN EXAMPLE OF BAT

The use of BAT in permitting industrial facilities is specified by the EU Industrial Emissions Directive (2010/75/EU). EU BAT reference documents are developed through extensive, rigorous and transparent consultation with experts from EU Member States, industry, environmental non-governmental organisations and European Commission services. Since BAT necessarily evolves with technology and the understanding of environmental phenomena, the BAT reference documents are regularly updated. Detailed BAT reference documents have been developed for 30 industries, and also for some techniques relevant to many industries.

BAT prescriptions can be very detailed. The 2017 BAT Reference Document for the Intensive Rearing of Poultry or Pigs has 898 pages. The 'BAT Conclusions' for this industry specify 34 best available techniques for the following: environmental management systems; good housekeeping; nutritional management (for reduced ammonia excretion); efficient use of water and energy; noise, dust, odour and ammonia emissions (including limits for different types of animals, such as sows with piglets, or laying hens); emissions from wastewater, solid manure and slurry storage; on-farm processing and landspreading of manure; emissions reductions; and monitoring of emissions and process parameters. For example, BAT 19 states: 'If on-farm processing of manure is used, in order to reduce emissions of nitrogen, phosphorus, odour and microbial pathogens to air and water and facilitate manure storage and/or landspreading, BAT is to process the manure by applying one or a combination of the techniques given.'

The given techniques are reproduced in [Table 6.3](#). Additional details about the techniques are provided in the BAT Conclusions, which are meant to guide facility operators in designing their operations and making a successful application for a permit to operate.

Source: EC ([2017](#)).

**Table 6.3 Best available techniques for on-farm processing of manure.** EC (2017).

Technique	Applicability
Mechanical separation of slurry. This includes, e.g.: - screw press separator - decanter-centrifuge separator - coagulation-flocculation - separation by sieves - filter pressing	This technique is only applicable when: - a reduction of nitrogen and phosphorus content is needed due to limited available land for manure application - manure cannot be transported for landspreading at a reasonable cost - the use of polyacrylamide as a flocculant may not be applicable due to the risk of acrylamide formation
Anaerobic digestion of manure in a biogas installation	This technique may not be generally applicable due to the high implementation cost.
Use of an external tunnel for manure drying	This technique is only applicable to manure from plants for laying hens, and not to existing plants without manure belts.
Aerobic digestion (aeration) of slurry	This technique is only applicable when pathogen and odour reduction are important prior to landspreading. In cold climates, it may be difficult to maintain the required level of aeration during winter.
Nitrification-denitrification of slurry	This technique is not applicable to new plants/farms, and only to existing plants/farms when the removal of nitrogen is necessary due to limited available land for manure application.
Composting of solid manure	This technique is only applicable when: - manure cannot be transported for landspreading at a reasonable cost - pathogen and odour reduction are important prior to landspreading - there is enough space in the farm for windrows to be established

### 6.3.2 Types of treatment

Many types of waste treatment processes exist, each of which can be designed to fit the specific purposes of a waste treatment operation and may be combined with other treatments. Waste treatment can occur on-site where the waste is generated, or off-site at a specialised plant that treats wastes from a variety of sources or industries. In this chapter, the treatments are categorised by their fundamental operating principles and purposes.

- *Physical treatment* commonly involves size reduction of solid materials, mixing or separation. In this book, the storage of waste is also categorised as physical treatment. Most treatment facilities, including MRFs and industrial waste treatment plants, apply at least physical treatment.
- *Physicochemical treatment* applies a combination of physical and chemical processes to separate components or makes waste less hazardous or reactive.

- *Biological treatment* is used to reduce the volume, reactivity and pathogen content of wastes, and can produce valuable nutrient streams or energy. It occurs in on-site industrial waste treatment plants, composting facilities and anaerobic digestion plants.
- *Thermal treatment* separates components of waste or reduces waste volume, reactivity or hazardous character. It often results in the production of fuels or energy from the organic component of wastes, leaving the inorganic elements in an ash byproduct. It takes place in industrial plants, including on-site industrial energy-from-waste plants and MSW incinerators.

A given waste stream may undergo several types of treatment in a process train. Most processes are applied in ‘continuous mode’, with a steady flow through the system. However, some processes treat one batch at a time, with each batch going through all stages of processing before the next batch is fed to the system. The following two sections give examples of process trains in facilities for household and industrial wastes. [Sections 6.4 to 6.7](#) provide more detail about the individual treatment processes.

### 6.3.3 Household waste treatment systems

Household waste treatment systems differ by collection method. When household food waste is collected separately, it may be taken to a local anaerobic digestion facility ([Section 8.4](#)). There, it undergoes several types of treatment: physical sorting to remove contaminants such as packaging; physicochemical treatment to make the biomass more degradable; and, finally, biological treatment to produce biogas. The biogas may be directly combusted (thermal treatment) for the generation of combined heat and power (CHP; [Section 8.3.4](#)) or cleaned to enter the gas grid.

When recyclable materials are collected separately, they are typically transported to a local MRF ([Figure 6.5](#)). The MRF will apply the following physical treatment processes.

- Workers at a picking line manually separate oversize products (e.g., office water-dispenser bottles), valuable items (e.g., copper wire or motors) and contaminants (e.g., textiles, batteries).
- A trommel or disk screen separates large pieces of cardboard and undersize materials that could jam the sorting equipment.
- A ballistic separator separates flat objects (e.g., paper) from three-dimensional objects (e.g., aluminium cans and plastic bottles) and heavier materials (e.g., glass and metal).

- A magnet removes ferrous (iron and steel) metal from the glass stream.
- An air classifier blows paper fragments out of the glass stream.
- An eddy current separator removes aluminium cans from the plastics stream.
- An optical sorter, which recognises different types of plastics based on their reflection of visible and infrared light, separates plastics with an air knife.

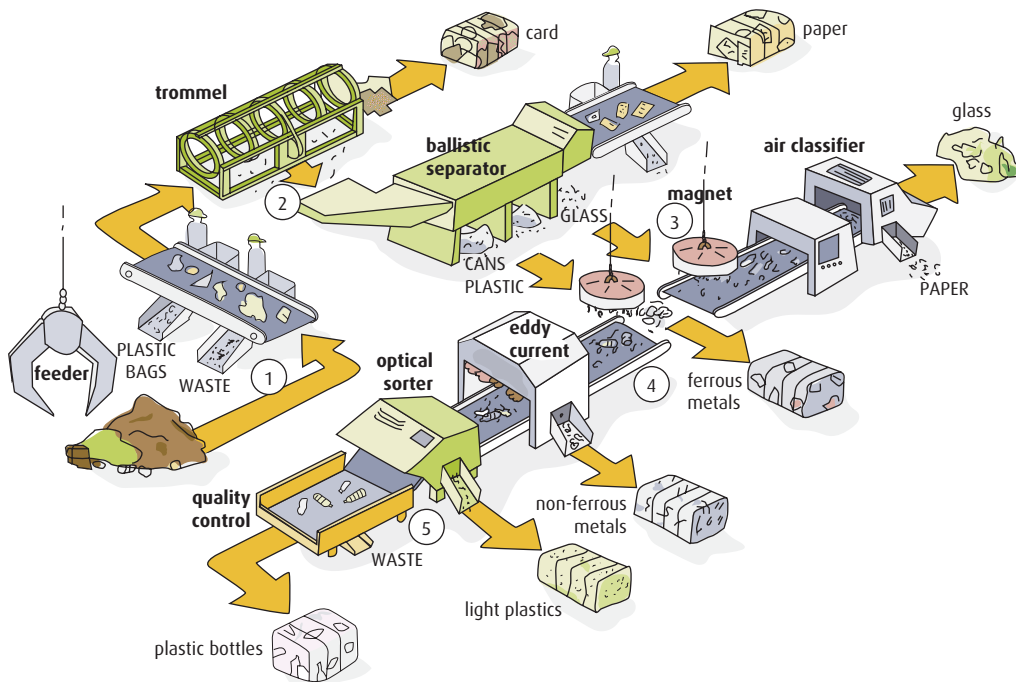

**Figure 6.5 A material recovery facility (MRF) with various treatment technologies.**

Redrawn from SUEZ recycling and recovery UK.

Mixed or residual waste may be sorted in a mechanical-biological treatment (MBT) facility instead of in an MRF. The MBT separates at least the metals and potentially paper and plastics for recycling, and applies composting or anaerobic digestion to the biological fraction of the waste. An MBT prepares refuse-derived fuel (RDF) from the remaining materials, often low-grade paper and plastic.

MBTs also produce a stream of inseparable solid material known as ‘compost-like output’ or CLO. This material is usually too contaminated to be an appropriate substitute for pure compost (such as for soil enrichment). It may be landfilled or combusted.

The sorted materials from an MRF or MBT are transported in large loads by truck, rail or ship for further processing. Materials of low value, such as CLO, are generally processed nearby. Mixed low-grade paper and plastic could continue by rail to fuel a cement plant several hundred kilometres away. High-grade plastic or paper, or scrap steel, might be shipped thousands of kilometres to be recycled in a carpet factory, paper mill or an electric arc furnace, respectively, on another continent. [Chapter 7](#) further explains the recycling systems for major material categories, including metals, paper and plastics.

#### 6.3.4 Industrial waste treatment systems

Industrial waste treatment systems are as diverse as the waste they treat. In some cases, the wastes are similar enough to virgin raw materials to be processed together after minimal pretreatment. For example, gypsum from the desulphurisation of power plant flue gases (known as flue gas desulphurisation gypsum, FGD, or desulphogypsum, DSG; [Figure 6.10](#)) can be used together with natural gypsum to produce plasterboard for lining internal walls of buildings. Other wastes may require extensive pretreatment or separate processing. The initial treatment often takes place on-site and typically reduces waste volume or hazard to enable transportation to another facility for further treatment.

[Figure 6.6](#) illustrates the use of common physical and physicochemical treatments in a process train of stirred-tank reactors (STRs) for metal-finishing wastewaters. These wastewaters result from coating a base metal with another metal that protects it against corrosion or improves its appearance, such as gold plating of silver jewellery or chromium plating of bathroom taps. Metal-finishing wastewaters are typically corrosive solutions; they contain toxic metals that remain in solution after applying the desired coating to a metal part. Their generation is explained further in [Box 6.3](#). Other metal-bearing wastewaters result from mining (acid mine drainage) and the washing of contaminated soil.

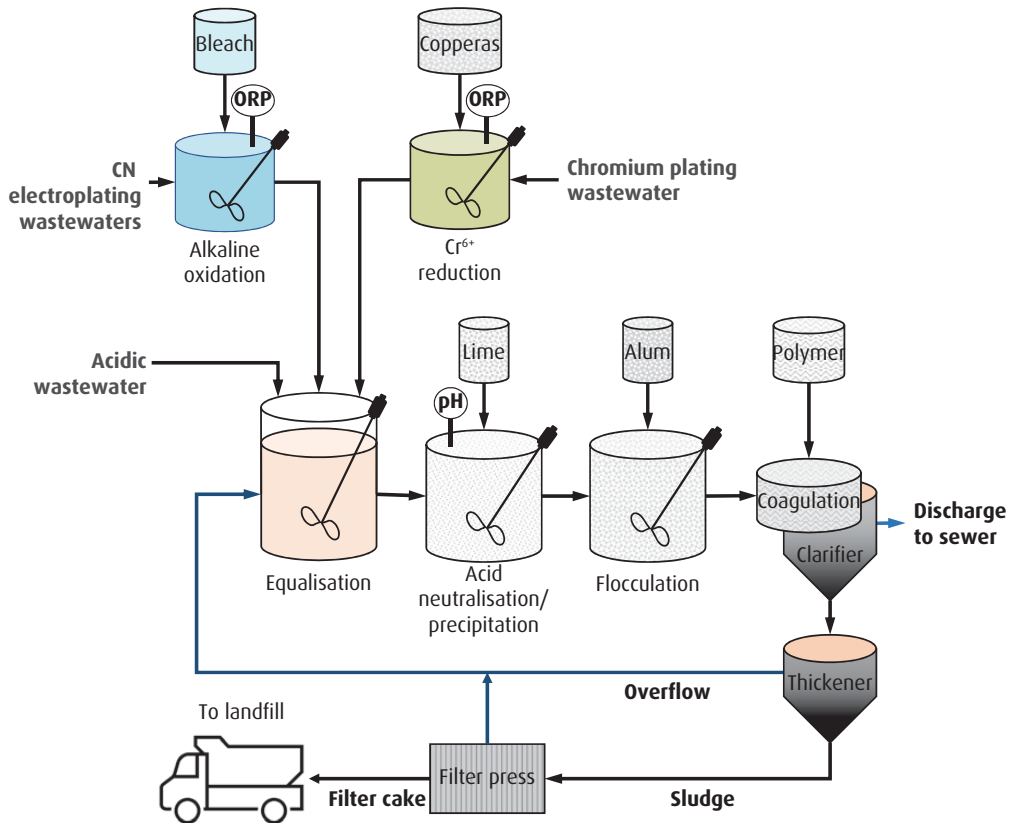

**Figure 6.6 Treatment of metal-finishing wastewaters.** Image: Authors' own.

The process train in Figure 6.6 reflects the treatments typically applied to metal-bearing wastewaters. First, oxidation and reduction destroy organic pollutants or convert the metals to a form that can be more easily removed from the solution. Second, neutralisation lowers the acidity of corrosive solutions and allows the removal of dissolved metals by precipitation. Third, flocculation and coagulation cluster pollutants as suspended solids, which are then separated from the water in a clarifier, thickener and filter press. Finally, the concentrated solid residue is removed for recovery, further treatment or disposal. Unless significantly contaminated, the water is discharged to the sewer (under an appropriate permit).

More specifically, Figure 6.6 shows three types of metal-finishing wastewaters entering the treatment system, each starting with a different treatment.

- Wastewater from spent cyanide (CN) plating baths receives initial treatment by oxidation (through alkaline chlorination with sodium hypochlorite, NaOCl, also known as bleach), to destroy the cyanide, before further treatment to remove dissolved metals.

- Wastewater from chromium plating is first treated by reduction (e.g., with ferrous sulphate,  $\text{FeSO}_4$ , also known as copperas, or sodium bisulphite,  $\text{NaHSO}_3$ ) to convert highly soluble hexavalent chromium ( $\text{Cr}^{6+}$ ) to trivalent chromium ( $\text{Cr}^{3+}$ ) that can be removed with other dissolved metals in the following treatment stages.
- Acidic wastewater (such as spent 'pickle liquor' from the cleaning of metal parts, or acidic plating) is not pretreated because it contains dissolved toxic metals in solution and enters the process at a later stage than the other wastewater.

The pretreated wastewaters are mixed together in an equalisation tank to reduce variations in the flow and composition of the wastewater. The mixed wastewater then goes through a series of physicochemical treatment processes.

- Neutralisation: hydrated lime ( $\text{Ca}(\text{OH})_2$ ) is added to decrease the solubility of the metals so they can be removed from solution as (precipitated) solid salts.
- Flocculation: aluminium sulphate ( $\text{Al}_2(\text{SO}_4)_3$ ) is added to cause the tiny dispersed solid particles to aggregate into larger particles (flocs).
- Coagulation: a polymer is added to help the flocs settle out from the solution.
- Clarification: the relatively clean overflow is removed for discharge to the sewer and the solids start to settle out in a sludge.
- Thickening: the sludge is further concentrated and liquid overflow is recirculated to the equalisation tank.
- Filter pressing: the sludge is further dewatered to produce a filter cake.

Each process requires measurement and control of key parameters. First, the oxidation-reduction potential (ORP) is particularly important for the oxidation and reduction processes. Second, the pH is critical for the precipitation of metals in the neutralisation tank and to avoid forming cyanide gas in alkaline chlorination. The ORP and pH must also be controlled in all other stages of this example. To this end, there may be minor additions of chemicals throughout the process train, primarily of acids, alkalis or oxidising or reducing agents, but also other chemicals with yet other purposes.

In [Figure 6.6](#), the metal-finishing filter cake is sent to an off-site landfill. Alternatively, the outputs from on-site waste treatment may be disposed of on-site, recovered on-site or recovered by other industries (industrial symbiosis; [Section 9.4.6](#)). While recovery is preferred, treatment of industrial wastes can at least remove hazardous properties before disposal. The treatment of waste can result in a change in the classification code ([Section 4.3.3](#)) or the removal of regulatory controls, which means the material can re-enter the production cycle under the same conditions as a primary feedstock.

### BOX 6.3 WASTE GENERATION BY THE METAL-FINISHING INDUSTRY

Metal finishing involves changing the surface of a metal to increase its durability or improve its appearance, or both. Some familiar examples of surface-treated metals are zinc-galvanised corrugated steel sheeting, chrome motorcycle components and gold-plated mobile phone charger contacts.

Metal finishing includes both physical processes, such as polishing, and chemical processes, such as etching and coating. Coating processes include anodising, galvanising, electroplating, electroless plating, phosphating and many more. Most of these processes involve immersing metal components in a solution of the metals to be deposited on their surfaces. This bath may be acidic, for example, sulphuric or hydrochloric acid, for plating metals such as chromium, copper, tin or zinc. Nickel, cadmium, silver and gold are usually plated using an alkaline cyanide bath.

Metal-finishing wastes include solid wastes, such as metal fragments contaminated with oil and grease, and abrasives contaminated with metals. Wastewaters include spent pickle liquor from immersing metal components in hydrochloric or sulphuric acid to remove stains and scale (they are 'pickled' just like the young cucumbers known as pickles), rinse waters from rinsing components between processing stages and spent plating baths.

A spent plating bath contains a mixture of metals because during plating not all of the metal in solution attaches to the surface of the component being coated. Moreover, metals are dissolved out of the components being coated. In large metal-finishing operations, and for expensive metals, ion exchange ([Table 6.5](#)) may be used to selectively recover metals from spent plating baths. This is not economically viable for smaller operations and cheaper metals, but wastewaters from different metal-finishing processes may be combined for treatment (as in [Figure 6.6](#)). The resulting filter cake contains a wide variety of toxic metals (e.g., Cd, Cr, Cu, Ni, Sn, Zn).



## 6.4 PHYSICAL TREATMENT

### 6.4.1 Storage

Waste may need to be stored before transport, treatment or recovery. Storage arrangements must consider that waste is often physically, chemically, biologically and/or thermally unstable. Many wastes have the potential to decompose and release odours, dust, gases and leachate, which may pollute the environment or can even explode. The following solutions may ensure the stable and safe storage of waste.

- Placement of a waste stockpile on an impermeable surface to enable collection and treatment of runoff.
- Enclosing waste in a container, such as a 205-litre drum or 1,000-litre intermediate bulk container (IBC), or tank, composed of or lined with an unreactive material.
- Enclosing a waste stockpile or containers in an industrial shed under negative pressure, with gas abstraction and treatment, to prevent the release of dust or gases, including odours.
- Management of the atmosphere and other storage conditions to avoid waste decomposition and subsequent release of hazardous pollutants.
- Secondary containment to prevent the escape of liquids and gases into the environment when the primary container leaks.

The inappropriate storage of waste can cause a variety of problems, with sometimes grave consequences, as illustrated by the news headlines in [Box 6.4](#).

#### BOX 6.4 IN THE HEADLINES: WASTE STORAGE

##### **‘COMPANY SAYS IT’S WORKING ON SEWAGE SMELL COMPLAINTS**

... complaints of the intense sewage odour have poured in to both the City of Sarnia and Ontario’s Ministry of the Environment, Conservation and Parks ... The site is approved to receive and temporarily store organic waste. That includes treated sewage solids and spent corn syrup from a fermentation process, which can be applied to farmland as fertilizer, according to the Ministry.’

Source: Jeffrey (2022).



### **'CHEMPARK FACTORY EXPLOSION IN GERMANY LIKELY CAUSED BY CHEMICAL REACTION**

Seven people were killed in the blast in the Chempark industrial area of Leverkusen on 27 July, and a further 31 people were injured ... a chemical reaction "probably" caused the spent liquid in a waste storage tank to self-heat rapidly, resulting in an increase in pressure that the tank could not withstand.'

Source: Euronews (2021).

### **'FIRE SAFETY HAZARD LEADS TO £50,000 FINE FOR WASTE FIRM DIRECTOR**

Essex wood treatment firm, Prime Biomass Ltd created [a] huge fire safety risk to the local community by storing more than double the agreed limit of wood waste. A jury at the Old Bailey returned unanimous guilty verdicts against two directors of an illegal waste wood operation in Essex.'

Source: Fire Protection Association (2021).

### **'FOUR KILLED IN AVONMOUTH WATER WORKS EXPLOSION**

A large explosion occurred in a silo that held treated biosolids at Wessex Water's premises on an industrial area ... Biosolids are solid organic matter recovered from a sewage treatment process and used as fertilizer. According to Wessex Water biosolids, "we treat sludge in anaerobic digesters to produce agricultural fertiliser and renewable energy."

Source: Kumar (2020).

### **'HAGERSVILLE FIRE CAUSED BY SPONTANEOUSLY COMBUSTING SHREDDED RUBBER**

A fire which Ontario Provincial Police say caused \$5 million damage to a business ... started at the park just south of town when bags of shredded rubber ... ignited from the heat of the day and spread to the building ... The fire was not very far from the site of the infamous 1990 Hagersville Tire Fire. The 17-day long blaze on Concession 13 consumed 14 million tires.'

Source: *The Hamilton Spectator* (2016).

While waste management companies derive revenue from collecting waste, they inevitably incur costs for storing and treating it. There is a risk that stored waste may be abandoned if waste treatment costs more than a company is willing or able to pay, ultimately leaving the costs to be covered by the taxpayer. To decrease these risks, as well as the risks outlined in [Box 6.4](#), regulators seek to minimise the quantity of waste that needs to be stored. Storage conditions and allowable volumes are usually specified in regulatory permits for facilities that generate or manage waste.

### EXERCISE 6.2 HOW TO NOT REPEAT HISTORY

Consider the headlines in [Box 6.4](#). What are the practices that led to these incidents?

Risk assessment is an important tool for the prevention of negative health, safety and environmental impacts from an industrial process. A formal risk assessment identifies the hazards and risks associated with a process and potential control measures to prevent negative consequences. What are the hazards and risks associated with the storage facilities mentioned in these news stories and what control measures can you suggest to prevent future problems of this kind?

#### 6.4.2 Size reduction

Most size reduction of wastes is undertaken to prepare them for other processes, with the exception of the crushing of inert mineral wastes to make hardcore for fill on construction sites. Size reduction may be necessary to fit materials into the processing equipment, to enable homogenisation or to increase the surface area for heat or mass transfer.

Materials for recycling, including wood, paper, plastics, glass and metals, are generally comminuted for decontamination and reprocessing, first into a clean, homogeneous feedstock, then into new products. Biomass is shredded to provide a larger contact area for efficient chemical pretreatment and then biodegradation by micro-organisms into compost or biogas and digestate. If not recycled, organic materials are also shredded for mixing to produce a homogeneous fuel for energy recovery. Materials may also be size-reduced to selectively recover some of their components. For example, end-of-life catalytic converters, used to reduce

emissions of toxic gases from car exhausts, are crushed and ground to enable recovery of platinum group elements by metallurgical processing.

Many types of specialty equipment for the size reduction of materials with different properties exist, including the following.

- Crushers apply sufficient force to a material to cause its fragmentation. Common examples are jaw crushers, which squeeze the material between a moving surface and a fixed surface, and impact crushers, which hurl the material against a fixed surface. They are most useful for reducing the size of brittle materials by a factor of two to ten and are not usually used to reduce materials to sizes smaller than centimetres.
- Grinders use abrasive shear forces to break up a material. Grinding mills consist of horizontally rotating cylinders in which hard grinding media, such as balls or rods, tumble and grind down the surrounding materials. Some materials are self-grinding and suitable for autogenous milling. Since abrasion takes place at the surface, grinders are not useful for reducing the size of large particles. Instead, they are often used after crushing to create powders with a high surface area, such as are needed for efficient hydrometallurgical processing.
- Cutters slice tough or ductile materials, including paper, plastic and metal, into pieces. To slice the materials, a series of rotating blades acts against a series of stationary blades attached to the mill casing.

Durable consumer goods, such as toasters or washing machines, may be dismantled for separate recovery of their component materials. Unfortunately, few are designed for disassembly, and the labour required to dismantle them is expensive, so they are broken up to recover the materials using mechanical processes. Products ranging from mobile phones to cars are processed through shredding plants, which use a combination of crushing and cutting to break the items into smaller pieces for the subsequent sorting of the materials (e.g., [Figure 6.7](#)). Similarly, the demolition of buildings typically starts with an internal strip-out of valuable metals used for wiring and plumbing, but the rest of the structure is crushed and the resulting debris is sorted for potential recovery of the various materials.

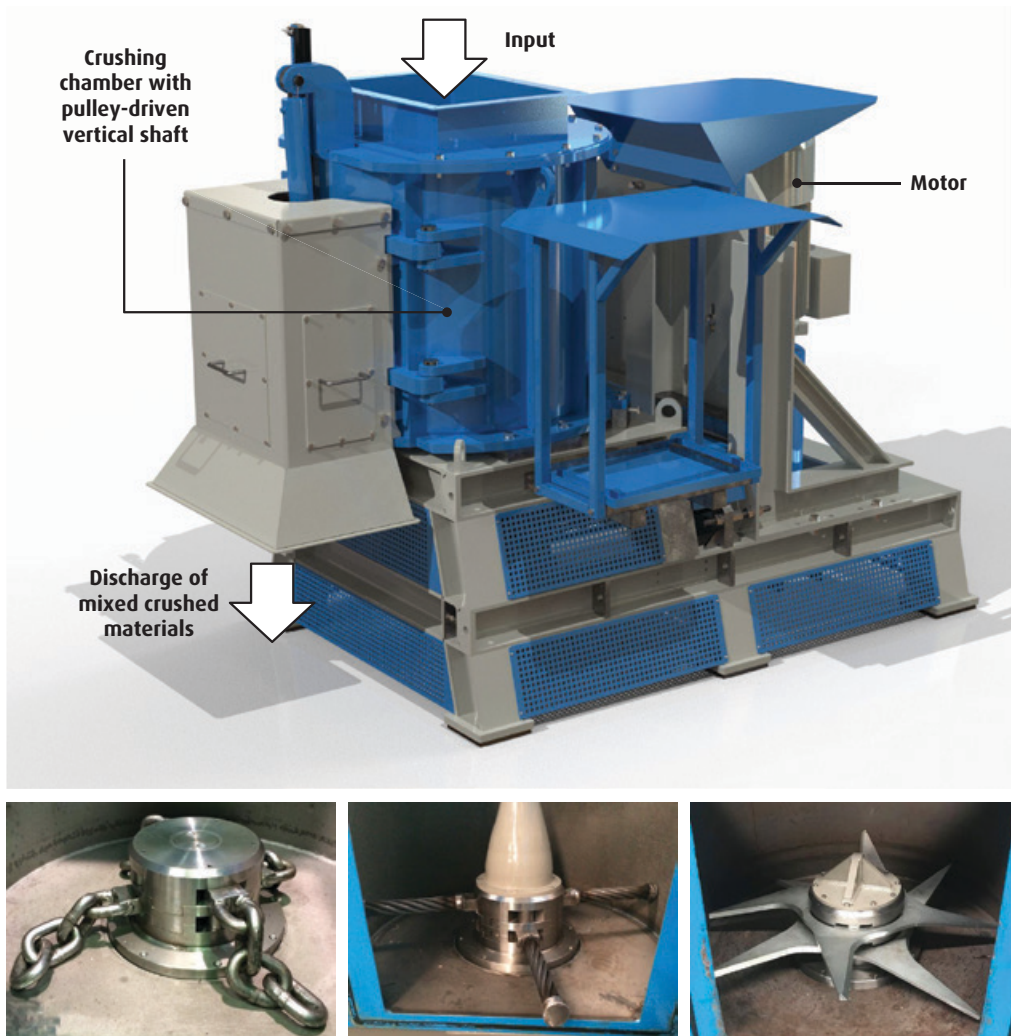

**Figure 6.7** A vertical waste crusher shredder machine (top) can crush several tonnes per hour of materials such as waste electrical and electronic equipment, biomass and slaughterhouse wastes. The machine can be adapted with different pulley-driven spinning heads (below) to crush or cut, as required by the application. Image: Donasonic.

### 6.4.3 Mixing

Wastes may be mixed in order to homogenise them and create a feedstock with consistent characteristics. They may also be mixed with water, chemicals or micro-organisms to remove or transform contaminants. The type of mixer needed depends on whether the material is a liquid, slurry, paste or solid. As with other process equipment, many variations have been developed for specific applications, but three main types prevail. First, paddle and ribbon mixers have blades attached to a central rotating shaft, which may be vertical or horizontal. Different shapes and configurations of the blades are used for materials of different viscosities, usually liquids or slurries. The shaft torque can be adjusted by the power of the motor that drives it to vary the mixer speed in different media. Second, drum mixers have no internal moving parts but usually have internal baffles. When the drum is rotated around a horizontal axis, the materials inside, usually solids or slurries, are buffeted and mixed by the baffles. Finally, in static mixers, the baffles are fixed to the inside of a pipe to mix a liquid (usually slurry or paste) as it flows through. [Figure 6.8](#) shows one example of a mixer.



**Figure 6.8 Drum-batch mixer mounted on rollers and with internal baffles.**

Image: materialflow.com.

---

### 6.4.4 Separation

Separation processes are used to sort or decontaminate mixed waste streams. A variety of physical characteristics can be exploited to accomplish separation. In traditional processes, the basis for separation includes particle size and/or shape, density, hardness, phase (solid, liquid, gas), miscibility, static charge, ferromagnetism and electrical resistivity. Melting point and boiling point may also be used for separation and are discussed under thermal treatment (Section 6.7).

More recent processes use sensors and robotics to assess and separate waste. The composition of the waste may be identified by the reflectance or adsorption of different wavelengths of electromagnetic radiation, including infrared, visible and ultraviolet light and X-rays. Alternatively, the waste may be video-captured and identified through powerful pattern-recognition algorithms. Advances in artificial intelligence have boosted the success of optical robotic sorting.

Table 6.4 lists a variety of separation technologies, each with a brief explanation of the principles of their operation and an example of an application. You can relate some of these back to the schematic diagrams of the MRF and metal-finishing waste treatment in Figures 6.5 and 6.6.

**Table 6.4 Physical separation technologies.**

Treatment process	Principle	Example applications
<b>Screening</b>	Size separation of particles based on whether they pass through the openings in a screen	
Vibrating screen	A flat screen vibrates side-to-side or in a gyratory motion to separate particles that pass or remain on the screen.	Size classification of recycled concrete aggregate from demolition
Trommel	A rotating drum with screens around its diameter is mounted on a shallow angle. Feed material enters at the top. Oversize material travels to the end of the drum, while undersize material passes through the screen for separate collection.	Removal of small materials from commingled recycling in an MRF
Disk screen	Profiled disks are mounted at staggered intervals on a series of adjacent rotating shafts, creating openings between the disks and the shafts. As feed material is moved along by the disks, materials pass through or over the openings depending on their size, shape, mass and flexibility, and also the profile, spacing and rotational speed of the disks.	Separation of cardboard and newspaper from other mixed papers and containers in an MRF; removal of oversized material from shredded biomass



**Table 6.4 (Cont.)**

Treatment process	Principle	Example applications
<b>Gravity separation</b>	Separation based on density	
Ballistic separator	A series of angled impellers with orbital motion fling incoming waste, separating materials that follow different trajectories depending on their weight and shape. Lightweight and flat (2D) materials are conveyed along the top, while heavy and rolling (3D) materials go to the bottom.	Separation of glass and stones from compostable materials; separation of residual waste or commingled recyclables
Sedimentation	Suspended solids are removed from a liquid (water) by settling in a tank or clarifier. A sludge containing the solids is collected as underflow from the bottom of the tank and water exits via an overflow at the top.	Separation of sewage sludge following activated sludge treatment of municipal wastewater; removal of precipitates created by neutralisation of acid mine drainage
Oil-water separation	An oil-water separator (originally developed by the American Petroleum Institute, API) is a tank that separates immiscible oil from water and solid particles by skimming the oil from the top and collecting the sludge from the bottom. Diagonal plates may be incorporated into the tank to facilitate the coalescence of oil droplets.	Separation of oil from refinery wastewaters; separation of transformer oil from rainwater and grit in runoff from electrical substations
Dissolved-air flotation	The buoyancy of suspended immiscible liquids or solids in water is enhanced by air bubbles so they can be removed in an overflow, or by skimming.	Fibre recovery from pulp and paper wastewater
Solvent extraction	An organic or inorganic solute is transferred from one liquid to another liquid in which it has higher solubility.	Removal of acrylonitrile from wastewater using a tributyl phosphate solvent
<b>Filtration</b>	Separation of solids from liquids or gases using a filter medium that allows the fluid to pass through but not the solid	
Granular media	Fine suspended particles are removed from a fluid by passing through a bed of fine granular medium (e.g., sand).	Removal of suspended solids in drinking-water treatment
Plate-and-frame	A system of alternating plates, filter membranes and frames used for dewatering a sludge or slurry. The sludge or slurry is pumped into sealed chambers created by compressing the plates and frames, such that the liquid filtrate is forced to exit through the filter membrane and a filter cake remains in the frame. When the filter resistance increases, the plates and frames are separated to collect the filter cake.	Dewatering of sludges following sedimentation, such as sewage sludge, mine tailings, precipitates from wastewater neutralisation etc.



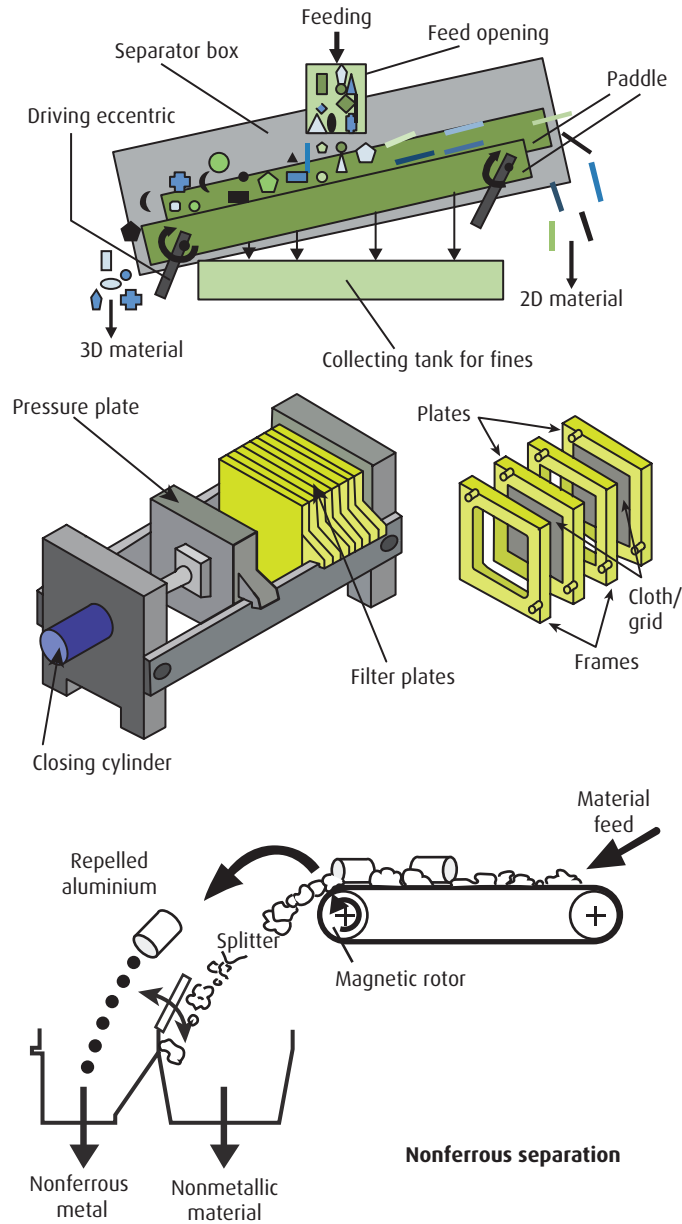

Table 6.4 (Cont.)

Treatment process	Principle	Example applications
Membrane separation	A membrane is engineered with porosity that allows selective passage of suspended solids, dissolved salts, metals or organic pollutants, bacteria or viruses for removal. Different driving forces (e.g., pressure, electrical potential, vacuum) may be applied to effect the separation, for example, in reverse osmosis, electro dialysis and pervaporation.	Reclamation of treated municipal wastewater as drinking water
Baghouse	Particulates are removed from a gas by drawing it through a long cylindrical fabric filter bag. Particulates build up on the fabric and are periodically shaken off and collected.	Removal of fly ash and scrubber reaction products from stack gas from MSW incineration
<b>Air classification</b>	Separation of materials based on their drag (size, shape and density) in a stream of air, in interaction with a housing	
Zigzag	Mixed materials are fed into a column of air that rises through a chamber with sharp angles that divert lighter particles up and heavier particles down for separate collection.	Removal of labels, paper and plastic wrappers from PET flakes in PET recycling
Cyclone	Particles are removed from a gas or liquid stream by vortex separation. The fluid flows at high speed in a helical pattern and larger particles drop out when they hit the outer wall.	Bagless vacuum cleaners for collection of household dust; removal of boiler ash entrained in stack gas from MSW incineration
Digital sorter/air knife	Objects are selectively removed from a conveyor by a jet of pressurised air based on the recognition of their characteristics by a sensor and intelligence system.	Separation of HDPE from mixed plastics in an MRF optical sorter
Electrostatic precipitation	Fine particles in a gas stream are electrostatically charged and then removed by attraction to grounded plates.	Removal of fly ash from stack gas from coal combustion
Magnetic separation	A magnet, such as a rotating drum magnet, is used to remove ferromagnetic materials from a mixed materials stream, which may pass under the magnet on a conveyor.	Removal of iron and steel from residual waste in an MBT plant
Eddy-current separation	A powerful magnetic field is used to induce eddy currents in nonferromagnetic metals, which causes them to be repelled and thrown from a mixed waste stream falling off a conveyor belt for separate collection.	Removal of aluminium and copper from bottom ash from MSW incineration

### EXERCISE 6.3 SEPARATING SEPARATION PROCESSES

Consider the images of separation processes in Figure 6.9. Which technologies from Table 6.4 do they depict?



**Figure 6.9** Physical separation process for comparison with Table 6.4.

Image: Authors' own.

## 6.5 PHYSICOCHEMICAL TREATMENT

### 6.5.1 Purpose and concept

Physicochemical treatment applies a combination of physical and chemical processes to reduce the risks associated with emissions (e.g., stack gas or water) before they are discharged into the environment, creating a more concentrated waste stream for further treatment, or to purify wastes for recovery as feedstocks. Organic pollutants are rarely recovered but can be destroyed, though there may be economic or other practical considerations that prevent their destruction if they are present in low concentrations. Inorganic contaminants cannot be destroyed but may be removed and concentrated for recovery or separate management. Inevitably, physical size reduction, mixing and/or separation (Section 6.4) are also part of the overall process. Table 6.5 summarises the principles that underlie a range of common physicochemical treatment technologies and provides an example of the use of each. Their application to gaseous emissions, wastewaters and solid wastes is discussed in the following sections.

### 6.5.2 Gases

Physicochemical treatment of gases can remove acid gases, particles and specific pollutants that arise from processes such as combustion, smelting and cement clinker production. First, a scrubber may use reagents such as hydrated lime, sodium bicarbonate or sodium hydroxide to neutralise acid stack gases. The reagents can be injected or sprayed as dry chemicals or as droplets of a solution or slurry. The neutralisation products are solid salts such as sodium chloride and gypsum (Section 6.3.4; Figure 6.10). Second, activated carbon particles may be injected into the gas stream to remove low concentrations of organic pollutants, such as the products of incomplete combustion, and also mercury. The carbon particles provide a surface that the contaminants are attracted to and stick to by adsorption. Finally, the acid gas reaction products, activated carbon with adsorbed contaminants and other particulates that would contribute to air pollution must be removed from the gas stream using separation technologies such as cyclones or electrostatic precipitators, or by a baghouse (Table 6.4).

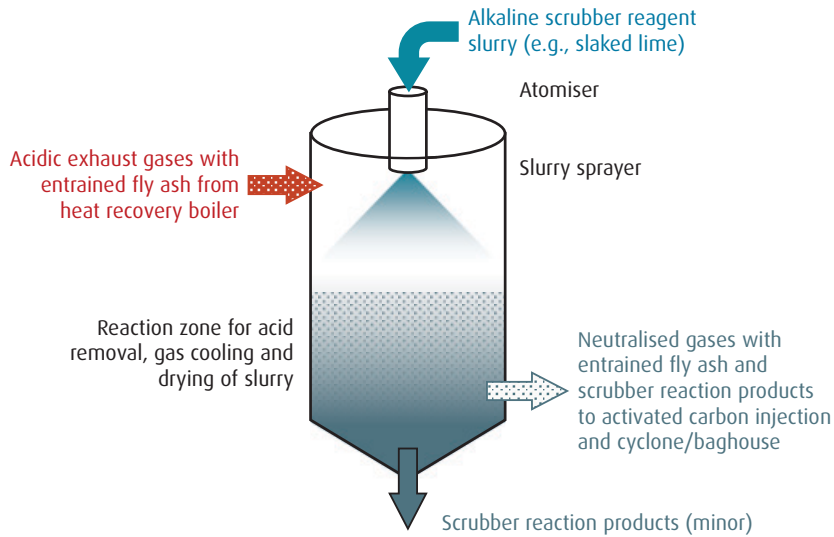

**Figure 6.10 Semi-dry scrubber for removal of sulphur dioxide ( $\text{SO}_2$ ) from flue gas using limestone to produce flue gas desulphurisation gypsum.** Image: Authors' own.

### 6.5.3 Wastewaters

Physicochemical treatment of contaminants in liquid wastes includes oxidation-reduction reactions and ion-exchange processes, as well as adsorption, neutralisation and precipitation.

*Oxidation* is a process in which organic molecules react with oxygen to produce energy, which can be chemical but also biological (Section 6.6) or thermal, such as combustion (Section 6.7). In all cases, oxidation can completely destroy organic contaminants to yield  $\text{CO}_2$  and water. However, the treatment is sometimes used to incompletely oxidise organic contaminants into less toxic or more useful intermediate compounds. Chemical oxidation is attractive for organic contaminants at low concentrations, since thermal oxidation would require heating the entire mass of waste.

*Reduction* entails the reaction of contaminants with chemicals that are themselves oxidised, to change the contaminants to a less toxic form. For example, electro-winning uses reduction to recover metals from a solution by plating them out on an electrode (cathode). It is commonly used as the final step to recover metals extracted from ores and can also be used to recover a range of metals from wastewaters. Since it requires the use of (costly) electrical energy, its economic feasibility depends on the value and concentration of the metals to be removed.

*Ion exchange* is used in metal recovery from ores and from wastewater. Purpose-designed synthetic ion-exchange resins can exchange specific desired elements in wastewaters for others of similar size and charge in the resin. The exchange may be reversible, in which case the desirable elements captured by the ion exchanger can be recovered. Since synthetic resins are often relatively expensive, natural ion exchangers such as humus and clays may be used, but these are more suited to removal rather than recovery.

*Adsorption* is widely used for the removal of metals from a solution. Figure 6.11 explains the underlying principle by showing the concentration-dependent distribution of a metal between a liquid and solid phase in a hypothetical system at equilibrium. At low concentrations (1), the metal is attracted to surface sites on the solid, and the amount of this adsorption to the solid depends on the amount of metal in the liquid. At higher concentrations (2), adsorption stops increasing because the surface sites are fully occupied. Treatment by adsorption is therefore mainly applicable to relatively low concentrations of contaminants, whether organic contaminants or metals.

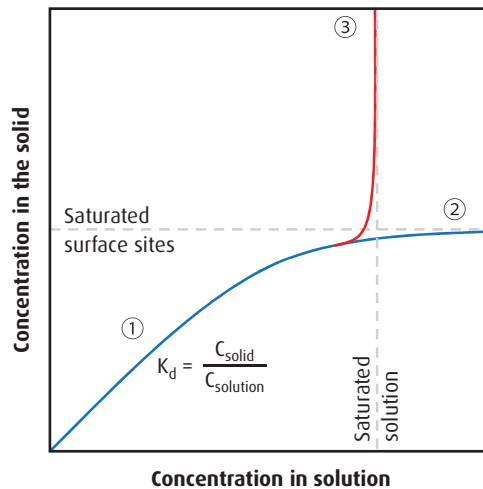

**Figure 6.11 Adsorption of metals from wastewater by a solid (1), followed by increasing dissolved concentration when surface sites are saturated (2), or precipitation of a new solid phase that limits the dissolved concentration (3).** Image: Authors' own.

*Neutralisation* (followed by precipitation) can be used to remove higher metal concentrations from acidic or alkaline wastewaters, because metals are more soluble in acidic (low pH) and alkaline (high pH) conditions. The same reagents

as in acid gas scrubbing, most often hydrated lime, can increase the pH of acidic wastewaters to 9–10, where most metal salts have their lowest solubility. Waste acids, often hydrochloric or sulphuric acid, are used to treat alkaline wastewaters. Neutralisation may also be used just to remove the corrosivity hazard (Table 2.2) associated with acidic or alkaline wastewaters.

*Precipitation* of metals as solid salt occurs follows the adjustment of the pH through neutralisation. This is shown by (3) in Figure 6.11. When precipitation occurs, the concentration in the liquid is limited to  $C_{\text{sat}}$ , regardless of how much metal is in the system. Since the recovery of metals requires them to be in solution, precipitation is generally practised for wastes destined for landfilling. The less-contaminated water remaining after precipitation may be suitable for discharge or require further treatment. Added chemicals can destabilise the charges on precipitate particles (coagulation) so they settle out of the liquid (flocculation). These processes are applicable to both inorganic and organic suspended solids. Their most common use is for settling sewage sludge following biological treatment (Section 6.6.2).

#### 6.5.4 Solid wastes

Both organic and inorganic compounds can be removed from solid wastes and contaminated soils by washing in water or leaching with more aggressive media. Additional treatment of the washwater is usually required to destroy or concentrate contaminants removed from the waste or soil to enable recovery or landfill, using the processes listed in the previous section. Stabilisation/solidification of solid waste with cement is sometimes suggested to encapsulate contaminants before landfilling. However, this is often not economically feasible because of the substantial amounts of cement required for the process to be effective. In the case of on-site treatment of contaminated soils, the creation of a highly alkaline, monolithic product is also incompatible with restoration of site biodiversity.

**Table 6.5 Physicochemical treatment technologies.**

Treatment process	Principle	Example applications
Washing	Contaminant particles, soluble salts and hydrophilic (polar) organic compounds in a solid waste or soil can be dispersed or dissolved by mixing with water. Hydrophobic (nonpolar) organic compounds can be dissolved by adding surfactants or using an organic solvent. The washwater (or another solvent) is then separated for subsequent recovery or concentration of the contaminants.	Removal of fine electric arc furnace dust particles from soil; removal of soluble chloride and sulphate salts from MSW incinerator bottom ash; removal of hydrophobic pesticides from contaminated soil



**Table 6.5 (Cont.)**

Treatment process	Principle	Example applications
Leaching	Leaching is similar to washing but the pH of the water (leachant) may be adjusted by the addition of (usually) acid or alkali; alternatively, complexing agents may be added to increase the solubility of contaminants. The leachate is separated for the concentration of the contaminants.	Leaching of rare-earth elements from waste electrical and electronic equipment (WEEE) using sulphuric acid
Electro-winning	An electric current is passed from an anode through a solution (wastewater or leachate) containing dissolved metal ions to recover metal by electrodeposition (reduction) onto a cathode.	Recovery of nickel from plating industry wastewater (spent plating bath)
Reduction	Reducing conditions (e.g., using a reducing agent such as $\text{FeSO}_4$ or $\text{NaHSO}_3$ ) are provided to destroy dissolved contaminants or convert them into a more desirable form, e.g., less toxic or less soluble.	Reduction of soluble toxic chromate ( $\text{Cr}_2\text{O}_7^{2-}$ , with $\text{Cr}^{6+}$ ) in tannery waste by $\text{NaHSO}_3$ for precipitation as $\text{Cr}(\text{OH})_3$ (containing $\text{Cr}^{3+}$ ); reductive dechlorination for the destruction of CFC refrigerants
Oxidation	Oxidising conditions (e.g., using chlorine, ozone or hydrogen peroxide ( $\text{H}_2\text{O}_2$ ) in combination with UV light) are provided to destroy dissolved contaminants or convert them into a more desirable form, e.g., less toxic or less soluble.	Oxidation of cyanide (CN) in gold-mining effluent to nitrogen ( $\text{N}_2$ ) and $\text{CO}_2$ using alkaline chlorination; disinfection of drinking water using chlorination
Adsorption	Dissolved contaminants are removed from a liquid or gas by accumulation on a solid surface.	Removal of mercury from MSW incinerator stack gas using activated carbon
Ion exchange	Ions in water are exchanged for ions from a solid.	Decontamination of plating baths to enable their recycling
Neutralisation	Acid is added to an alkaline solution, or alkali to an acidic solution, to achieve a non-corrosive pH.	Addition of powdered limestone ( $\text{CaCO}_3$ ) to neutralise acid mine drainage
Precipitation	Chemical conditions are altered (e.g., by the addition of reagents that provide hydroxide, carbonate or sulphide) to cause precipitation of dissolved contaminants as solids that can be removed, e.g., by sedimentation.	Precipitation of lead from soil-washing wastewater using hydrated lime ( $\text{Ca}(\text{OH})_2$ )
Coagulation and flocculation	Chemicals are added to destabilise the charges on particles, colloids or oily materials in suspension, and cause them to aggregate into flocs for easier separation from liquids (by sedimentation or filtration).	Use of ferric chloride ( $\text{FeCl}_3$ ) to remove particles from treated wastewater before discharge
Scrubbing	Wet or dry reagents are injected into a gas stream to remove pollutants.	Use of hydrated lime to remove sulphur dioxide ( $\text{SO}_2$ ) and hydrogen chloride (HCl) from stack gas from MSW incineration

## 6.6 BIOLOGICAL TREATMENT

### 6.6.1 General principles

Biological treatment processes use micro-organisms to oxidise organic compounds into gaseous emissions, liquid wastewaters and solid wastes and soils. Biological treatment may also be used to remove nitrogen compounds and phosphorus from municipal or industrial wastewaters. The biodegradability of organic compounds is variable and, as with chemical or thermal oxidation, the goal of biological treatment is not necessarily to fully oxidise organic compounds to CO<sub>2</sub> and water. Various process design variables are used to influence the decomposition of organic substrates into a variety of products, such as inoculation with specific micro-organisms, physicochemical pretreatment, oxygen levels, temperature, residence time, salinity, pH and others.

Since eutrophication is a key source of environmental harm associated with the discharge of organic wastes in the environment ([Section 2.3.3](#)), biological treatment is most often used to reduce the biological oxygen demand (BOD; [Section 8.5.4](#)) associated with easily degradable compounds. Organic pollutants present in low concentrations, for example, in contaminated soil, may also be tackled by biological treatment. Unfortunately, some of the organic compounds most toxic to humans and other animals are also the most difficult to degrade, in part because they may also be toxic to the micro-organisms. They are generally chemically stable, and therefore persistent in the environment. Consequently, they accumulate in environmental media to ever-more-toxic levels.

[Figure 6.12](#) displays the use of several biological treatments (along with others introduced elsewhere in this chapter) for wastewater from a pulp and paper plant. The wastewater has a high concentration of organic materials and hence a high BOD. The organic compounds are biodegraded in an activated sludge basin; the resulting sludge is settled in a clarifier and subsequently turned into biogas in the anaerobic digester. The gas may be used to generate renewable heat for the pulp and paper plant. [Table 6.6](#) summarises a range of these and other common biological treatment technologies and provides an example of the use of each. Their application to gaseous emissions, wastewaters and solid wastes is explained in the next three sections.





**Figure 6.12** An activated sludge aeration basin (centre), clarifiers (right) and anaerobic digesters (left) used for treatment of high BOD wastewater from the pulp and paper industry. Image: Veolia Water Technologies/Wesley Santos/Agência PressDigital.

**Table 6.6** Biological waste treatment technologies.

Biological treatment process	Principle	Example application
<b>Aerobic treatment</b>	Breaking down of organic compounds by microbes that use oxygen in their metabolism	
Activated sludge	Organic compounds in water are biodegraded in a concentrated suspension of aerobic micro-organisms in the presence of dissolved oxygen.	Removal of organic substrates from municipal and industrial wastewaters
Rotating biological contactor	Organic compounds in water are biodegraded by aerobic micro-organisms attached to a partially immersed rotating disk.	Removal of organic substrates from a chemi-thermomechanical pulp mill wastewater
Biological fluidised-bed reactor	Organic compounds in water or gas are biodegraded by aerobic micro-organisms attached to granular media in a fluidised bed.	Removal of ammonia and nitrites from aquaculture wastewaters
Trickling filter	Organic compounds in water are biodegraded by percolation through a granular medium that provides a support for aerobic micro-organisms.	Degradation of organic substrates in sewage from a septic tank
Membrane biological reactor	A compact activated sludge process that uses a membrane for liquid-solid separation instead of settling.	Removal of organic substrates from municipal and industrial wastewaters
Biofilter	Gaseous organic compounds are biodegraded by aerobic micro-organisms attached to a granular support in a packed bed.	Destruction of VOCs in the off-gas from air-stripping of contaminated groundwater; removal of odour compounds from air emissions from an MBT plant



**Table 6.6 (Cont.)**

Biological treatment process	Principle	Example application
Windrow composting	Solid organic waste is biodegraded by aerobic micro-organisms in long rows of piles (typically 1–3 m high x 4–5 m wide), which are aerated by periodic manual or mechanical turning. Temperature and moisture are controlled through the pile size.	Degradation of centrally collected food waste to produce compost
Static-pile composting	Solid organic waste is biodegraded by aerobic micro-organisms in one large pile, layered with loosely piled bulking agents (such as wood chips or shredded newspaper) to enable air to flow from the bottom to the top. The airflow may be assisted by air blowers.	Degradation of centrally collected garden waste to produce compost
In-vessel composting	Solid organic waste is biodegraded by aerobic micro-organisms in a drum, silo, concrete-lined trench or similar, usually with automated control of temperature, moisture and oxygen.	Treatment of sewage sludge in urban areas where odour control is particularly important
<b>Anaerobic treatment</b>	Breaking down of organic compounds by microbes that use oxygen in their metabolism	
Anaerobic digestion	Solid organic waste is biodegraded by anaerobic micro-organisms to produce biogas composed of approximately 60 per cent methane (CH <sub>4</sub> ) and 40 per cent CO <sub>2</sub> , with trace amounts of hydrogen sulphide (H <sub>2</sub> S), ammonia (NH <sub>3</sub> ) and other gases, and a digestate slurry containing nutrients and nongaseous decomposition products.	Production of biogas and fertiliser from centrally collected food waste
Nitrification/denitrification	Ammonia is oxidised to nitrite and then to nitrate under aerobic conditions, followed by the reduction of nitrate to nitrogen gas under anaerobic conditions.	Removal of ammonia from landfill leachate
Biological phosphorus removal	Organisms accumulate phosphorus under anaerobic conditions and the phosphorus is removed from the resulting biomass.	Removal of phosphorus from municipal wastewater

### 6.6.2 Aerobic treatment of wastewater and gases

Aerobic treatment refers to the decomposition of wastes using micro-organisms that mainly rely on oxygen to oxidise organic compounds. Aerobic micro-organisms can use oxygen from the air or dissolved in water to degrade many different types of organic compounds, often in just hours or days. As is the case for humans, the respiration of aerobic micro-organisms produces CO<sub>2</sub> and water.

As is also the case for humans, some organic compounds cannot be digested if microbes do not have the necessary enzymes.

The most common type of aerobic wastewater treatment is probably the activated sludge process, which is at the heart of most municipal sewage treatment plants. It can also be used for industrial wastewaters that contain high concentrations of organic compounds, for example, from agriculture, breweries, dairy plants, food-processing plants, tanneries, pulp and paper mills, pharmaceutical manufacture and many others. The activated sludge process can also oxidise odorous and toxic ammonium in wastewater to nitrate (which is removed by anaerobic organisms; [Section 6.6.4](#)).

The activated sludge process consists of the following elements.

- The central component of the activated sludge process is an aeration basin, in which wastewater is brought into contact with oxygen.
- Micro-organisms are already present in the wastewater and do not need to be added. They clump together in suspended flocs and feed on the organic compounds in the wastewater.
- Circulation of the wastewater, often by air sparging, ensures good contact between the flocs of micro-organisms and the organic compounds and oxygen.
- The hydraulic retention time is the time spent by the wastewater in the aeration basin. It depends on the time required for the degradation of the organic compounds but could be around a day.
- After the degradation has taken place in the aeration basin, the micro-organisms are flocculated and coagulated for the settling of sludge in a clarifier.

Some of the sludge in the clarifier underflow is returned to the aeration basin to increase the concentration of micro-organisms. The rest of the sludge is dewatered. It still contains a large amount of organic matter, mainly dead microbial cells, that cannot be efficiently degraded in the aeration basin. The energy stored in this organic matter can be recovered by anaerobic digestion to produce biogas ([Section 8.4](#)). The relatively clean clarifier overflow may undergo additional physicochemical treatment, such as granular media filtration or adsorption ([Section 6.5.3](#)), before discharge.

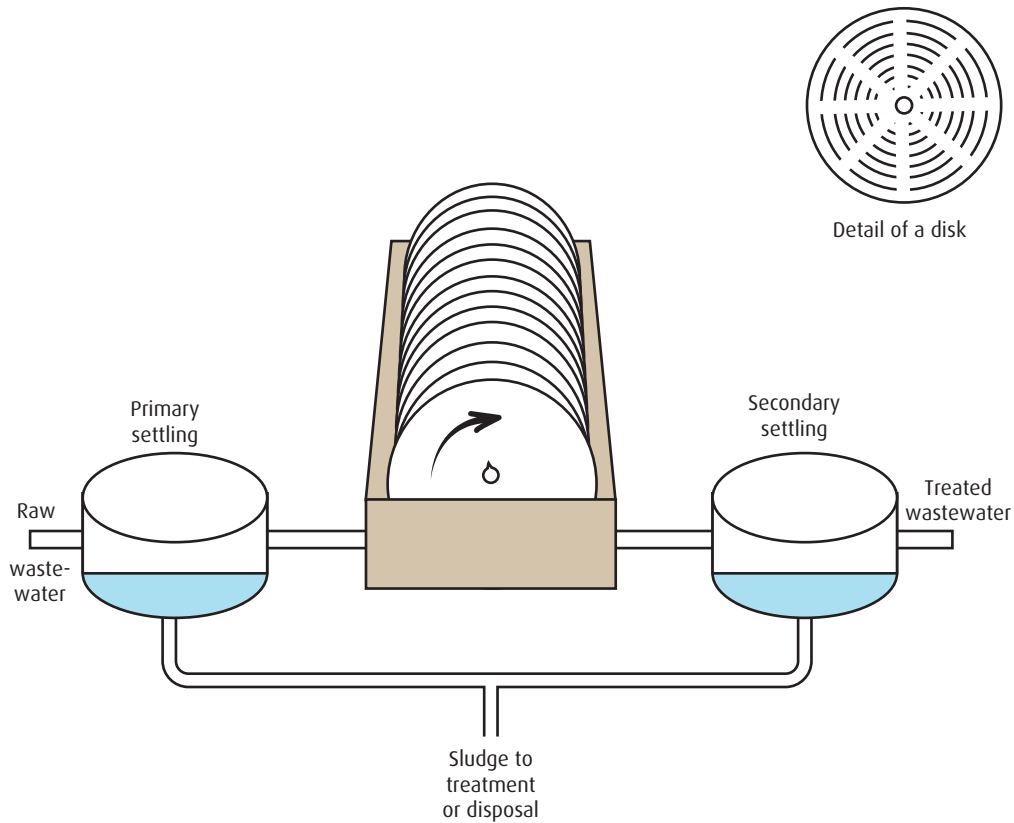

**Figure 6.13** The disks of a rotating biological contactor provide a high surface area for the growth of micro-organisms. Partial immersion of the disks in wastewater allows the micro-organisms to pick up organic matter, and rotating the disks provides air for aerobic degradation. Image: Authors' own.

In other types of aerobic wastewater treatment, the microbes that feed on the organic compounds in the wastewater form a biofilm attached to a solid surface. In a rotating biological contactor, the biofilm forms on circular plates that dip in and out of wastewater as they rotate to provide oxygen to the microbes (Figure 6.13). In a trickling filter, the biofilm forms on particle surfaces, and oxygen is provided by a high air-liquid interface area associated with interparticle porosity. Management of dead microbial cells from these

systems is more difficult and particle-based systems can become clogged. They are less suitable for high-volume applications. Aerobic biofilters for the decomposition of organic compounds in gas streams are also based on microbial biofilms attached to particles.

### 6.6.3 Aerobic treatment of solid wastes (composting)

The aerobic treatment of solid organic wastes is known as composting. Many people have a compost heap or drum in their garden. Mixing moist leafy-green material and some food waste with woody material provides a porous matrix that allows movement of air. It also balances the ratio of carbon to nitrogen (C:N; [Section 8.4.2](#)) to support the growth of aerobic micro-organisms. The compost is turned over with a pitchfork every couple of months to provide oxygen (air) to the micro-organisms. The biological activity generates heat, which can have a sterilising effect, remove plant pathogens and kill any seeds of weeds. It can even become sufficiently hot to self-ignite, which is also a risk associated with the storage of waste biomass. After a while, depending on temperature and moisture, the easily degraded organic matter is converted to CO<sub>2</sub> and water.

Composting reduces the mass of organic waste by 40–70 per cent. The remaining mass is composed of recalcitrant organic matter that is harder to degrade, along with a small proportion of minerals. Compost can be added to soil, where it helps to manage soil moisture. The organic matter in soil continues to degrade over a longer period of time, meanwhile providing a food source and habitat for organisms that support soil and plant health.

Home composting is used mainly for garden waste since food wastes, especially meat, are more odorous and may attract pests. Industrial-scale composting facilities are used for the centralised management of food wastes collected from households or industrial organic wastes mainly from agriculture or the food industry. In industrial-scale composting, proportions of different organic materials, moisture, temperature and aeration are controlled to achieve rapid decomposition. At an industrial scale, composting is managed in windrows, static piles (e.g., [Figure 6.14](#)) or in a reactor vessel ([Table 6.6](#)).



**Figure 6.14** Weekly collection of yard waste in plastic bags in Serdang, Selangor, Malaysia (a); mixture of yard waste with livestock manure at the beginning of composting (b); static compost pile at 35 days (c); finished compost (d). Image: Abdul Rahman et al. (2020).

The supply of oxygen to micro-organisms is usually somewhat imperfect, leading to zones of anaerobic decomposition (Sections 6.6.4 and 8.4), generating the emission of small amounts of hydrogen sulphide, ammonia and other odorous compounds, and methane. The latter is a concern because it has approximately 30 times the 100-year global warming potential of  $\text{CO}_2$ . Moreover, compared to anaerobic digestion (see the next section), a major disadvantage of composting is that it does not harvest the biochemical energy stored in the organic compounds.



### 6.6.4 Anaerobic treatment

Anaerobic treatment refers to the degradation of organic compounds in the absence of oxygen. Some micro-organisms are capable of both aerobic and anaerobic metabolism, depending on whether oxygen is present; other organisms can only do one or the other. Since oxygen is required to completely oxidise organic materials to  $\text{CO}_2$  and water, organic waste is not fully oxidised under anaerobic conditions. The products of anaerobic metabolism therefore still contain a lot of biochemical energy, and some can be used as a fuel. Examples are ethanol ( $\text{C}_2\text{H}_5\text{OH}$ ), methane ( $\text{CH}_4$ ) and hydrogen ( $\text{H}_2$ ). Anaerobic decomposition can also produce organic acids, which can be precursors for the production of other useful organic compounds (Box 8.3 and Figure 8.6).

Anaerobic treatment is often part of an activated sludge process train (Section 6.6.2) for wastes, such as sewage or farm wastes, that contain nitrogen and phosphorus. An anaerobic zone is provided for the conversion of nitrate, formed by the oxidation of ammonia in the aeration basin, to nitrogen gas. Providing an anaerobic zone before the aeration basin also encourages phosphate-accumulating organisms to take up phosphorus. The accumulated phosphorus is then removed in the clarifier as part of the cells that form the sludge.

Anaerobic digestion is the most common form of anaerobic treatment. It has a long history of use for the treatment of agricultural manure and human sewage. These wastes are highly biologically active and release odours and environmental pollutants if they are discharged into the environment without treatment. In recent decades, anaerobic digestion has also become the treatment of choice for centrally collected food waste. It is an important process for the recovery of energy from waste through biogas and is therefore discussed in more detail in Section 8.4.

The time required for anaerobic digestion is likely to be at least several weeks because anaerobic processes are much slower than aerobic processes. Anaerobic digesters can be operated over a range of temperatures. Anaerobic digestion at ambient temperatures requires less energy and encourages a diverse range of micro-organisms for stable digester operation. Higher temperatures (up to  $70^\circ\text{C}$ ) may be used to kill pathogens and speed up digestion.

Anaerobic digestion produces a biogas composed of approximately 60 per cent methane and 40 per cent  $\text{CO}_2$ . It also generates digestate containing the water that was present in the original waste, inorganic minerals such as the nutrients phosphorus and potassium, and some of the nitrogen and poorly degradable organic matter. Because of its high nutrient content, digestate is a good fertiliser. However, the high content of dissolved nutrients presents a risk to ground and surface waters if the digestate is applied at a rate high enough to prevent plants from absorbing all the nutrients.

## 6.7 THERMAL TREATMENT

### 6.7.1 Purpose and concept

Thermal treatment applies temperature changes to separate wastes or to reduce their volume, reactivity or hazardousness. Thermal treatment often results in the generation of fuels or heat, as well as emissions and solid ashes. [Table 6.7](#) summarises the common types of thermal waste treatment and provides examples of their use. The treatments are discussed further in the next two sections, which are organised by the two main purposes of thermal treatment: separation of components from the waste and permanent alteration of organic matter or specific organic substances in the waste.

**Table 6.7 Thermal waste treatment technologies.**

Thermal treatment process	Principle	Example application
<b>Thermal separation</b>	Separation of components from wastes based on their melting or boiling points	
Drying	Water is removed from a solid by evaporation.	Drying of sewage sludge before incineration
Thermal desorption	Volatile components are removed from a solid by evaporation.	Removal of hydrocarbon contaminants from drill cuttings (from drilling oil and gas wells, or mineral exploration boreholes)
Air-/steam-stripping	Volatile components are transferred from a liquid to a gas phase under conditions that increase the contact between the liquid and gas (e.g., aeration tank, spray tower or packed bed).	Removal of BTEX (benzene, toluene, ethyl benzene and xylene) from groundwater
Distillation	Liquid components are separated based on their boiling point, using a distillation column with plates that improve separation efficiency, with condensation of streams of increased purity.	Separation of waste lubricant motor oil into different fractions for recycling into lubricant production
Freeze crystallisation	Freezing is used to separate relatively pure water crystals from a more concentrated saline or acidic solution.	Low energy recovery of cleaner water from mining wastewater in regions where ambient temperatures below 0°C are common
<b>Thermal destruction</b>	Use of heat to thermally decompose organic wastes	
Disinfection	Waste is heated, often using steam, and sometimes under pressure, to kill biological organisms present in the waste.	Autoclaving of waste clothing in the production of shoddy to be used in mattresses





**Table 6.7 (Cont.)**

Thermal treatment process	Principle	Example application
Catalytic oxidation	Trace organic compounds are decomposed in a gas stream at elevated temperatures (e.g., 450°C) in the presence of oxygen and a catalyst.	Destruction of VOCs in the off-gas from thermal desorption treatment of soil using a metal oxide catalyst
Coprocessing	Waste is used to partially or fully replace fossil fuels or natural raw materials in energy-intensive industries, e.g., power generation, or cement or steel production.	Reuse of waste solvents as fuel in cement kilns
Incineration	Organic compounds are combusted at high temperatures (e.g., 780–1,450°C) in the presence of oxygen (air), e.g., in a modular incinerator, mass-burn incinerator, rotary kiln, fluidised bed, multiple-hearth furnace or liquid-injection furnace.	High-temperature (approximately 1,000°C) combustion of clinical (medical) waste
Gasification	Organic compounds are converted into a syngas at high temperatures (e.g., 700–1,000°C), with control of oxygen and water content to avoid combustion. The syngas can be used as a fuel or as a chemical feedstock.	Thermal decomposition of waste plastics into syngas
Plasma gasification	An ultra-high-temperature (> 2,000°C) plasma torch powered by an electric arc is used to convert organic matter into syngas and melt inorganic matter into a slag.	Conversion of soil contaminated with PCBs; sewage sludge
Pyrolysis	Organic compounds are decomposed into gas, oil and char at elevated temperatures (e.g., 400–700°C) in the absence of oxygen.	Thermal decomposition of sewage sludge to create a fuel oil and char
Torrefaction	Organic compounds are decomposed into volatile compounds and char at moderately elevated temperatures (e.g., 200–320°C) in the absence of oxygen.	Upgrading agricultural waste to a fuel with higher energy density

### 6.7.2 Temperature-based separations

Thermal separation processes use temperature to induce phase changes in the waste components, which enable their physical separation. Commonly, wastes are heated to volatilise the components to be separated.

*Drying* is a common and straightforward example of removing moisture from solids. Drying has numerous applications in waste management (and elsewhere). Natural air drying is a purely physical process, which can be all that is required to achieve the desired water content and has no associated energy costs. However,

waste can be dried more rapidly by heating it, often using waste heat from other processes (Chapter 8) or solar energy.

*Thermal desorption* also applies heat to achieve volatilisation but removes volatile organic compounds rather than water. This technology is often used to remove hazardous substances, including mercury and toxic organic compounds, from contaminated soil (Figure 6.15). Another application is the removal of hazardous hydrocarbons from drill cuttings before land disposal. The drill cuttings arise in mineral exploration and the production of oil and gas. The hydrocarbons are evolved in a gas stream and may be removed by condensation or adsorption, or destroyed by catalytic oxidation.

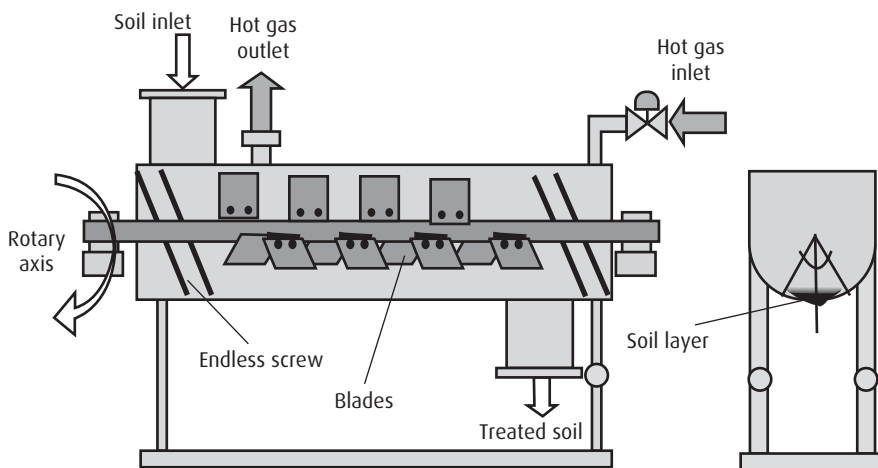

**Figure 6.15 Schematic diagram of a countercurrent thermal desorption unit for removal of volatile pollutants from contaminated soil.** Adapted from Mechat et al. (2004).

*Air or steam stripping* also removes volatile organic compounds from a liquid, by using air or steam. This treatment is used to remove solvents or petroleum hydrocarbons from wastewater, such as rinse or wash water. Elevated temperatures and high contact surface area improve removal. The latter can be achieved in the same way as for aerobic treatment of wastewater, in an aeration tank or packed bed, or by spraying the liquid.

*Distillation* separates miscible liquids based on their boiling points. A distillation column heats the liquid solution to evaporate the more volatile

component. Several volatilisation and condensation stages can be provided to increase the purity of the gas condensed at the top of the column. For complex mixtures, a refinery composed of several columns and including other physicochemical processes, such as cracking and synthesis, may be used. Distillation is used to separate used solvents and lubricants into usable fractions.

*Freeze crystallisation* is very different from other forms of thermal treatment because it does not operate at elevated temperatures. It is based on the principle that pure water freezes at a higher temperature than brine. Freezing can therefore be used to separate out relatively pure ice from salt or acid wastewater. It is a useful technique in cold-weather regions, where freezing may occur naturally, and therefore has no additional associated energy costs.

### 6.7.3 Thermal destruction of waste and contaminants

Organic compounds, particularly those of biological origin, have limited thermal stability. The temperatures required to destroy polymers, even those developed for high thermal stability, such as polytetrafluorethylene (PTFE, Teflon), are below 400°C. The heating of waste is therefore a good way to destroy organic waste or any pollutants it contains, or both, although some toxic compounds require higher temperatures. In the absence of oxygen, the thermal decomposition of organic compounds leads to other organic compounds with more stable bonds. In the presence of oxygen, organic compounds are oxidised. As discussed for chemical and biological oxidation, oxidation releases energy, which can be captured and used.

Heat-based disinfection can destroy biological contaminants, such as bacteria, viruses or prions in human and animal waste or clinical waste, or undesirable seeds in compost. Complete sterilisation of waste can be difficult to achieve because some organisms are more resistant to heat than others. The degree of disinfection depends on the organisms present, temperature, time and the method of contact. Disinfection processes apply pressurised steam at 121°C or 134°C since it effectively delivers the heat to destroy the organisms.

Torrefaction, pyrolysis, gasification and incineration (Table 6.7) are higher-temperature processes used to treat wastes with a high content of organic matter. These processes are distinguished by their operating temperatures and the amount of oxygen (air) that is supplied to react with the organic matter, resulting in different main products. The different operating regimes are illustrated in Figure 6.16.

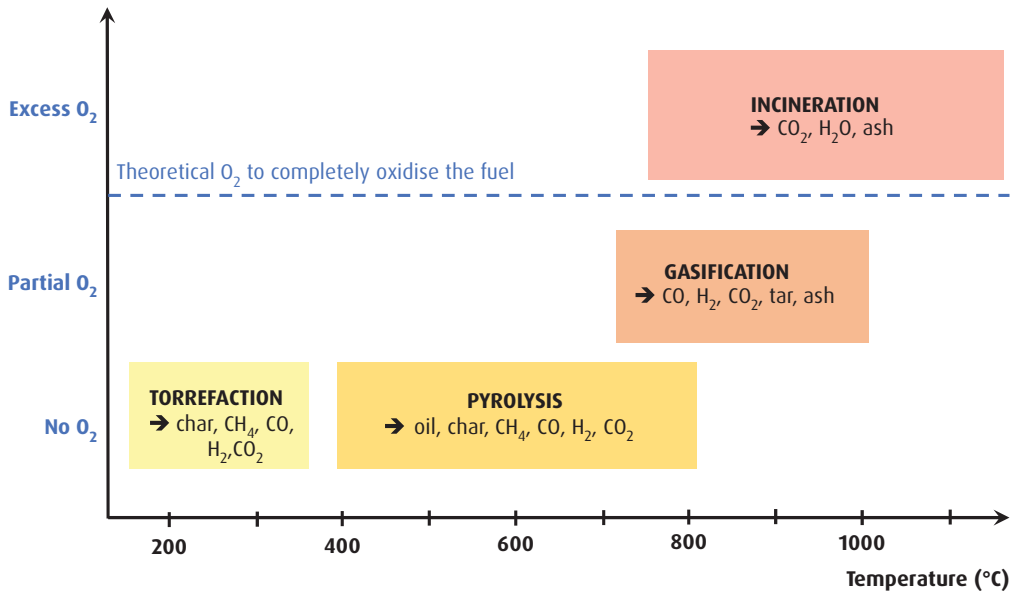

**Figure 6.16 Processes for thermal destruction of organic wastes and pollutants: main end products, oxygen requirements and temperature ranges.** Image: Authors' own.

Incineration has been practised since the dawn of human civilisation and is still the most common thermal process for the destruction of organic waste. It provides near-complete destruction of organic waste by complete combustion in excess air at high temperatures. The main products of the complete oxidation of organic waste are CO<sub>2</sub>, water and energy. For nonhazardous wastes, such as MSW, sewage sludge or paper sludge, an operating temperature of around 800°C is typical. A higher operating temperature, above 1,000°C, is needed to ensure the complete destruction of hazardous organic compounds, such as those in pesticide, solvent or paint wastes. Clinical waste from medical facilities, which may contain pathogens, is also burnt at higher temperatures.

Most designs for waste incinerators resemble power plants, since the energy from incineration is often recovered. The most common type of modern incinerator is the mass-burn incinerator (Figure 8.2), which is discussed in more detail in Section 8.3 in the context of energy recovery. Since organic wastes have a high energy content, it is also common to coprocess them with other fuels. For example, a small proportion of RDF from an MBT (Section 6.3.3), or wood waste, might be burnt together with pulverised coal in a coal-fired power station. Waste solvents can be burnt in cement kilns, where the operating temperature of 1,420°C ensures that all hazardous components are destroyed.

Torrefaction, by heating at 200–300°C without oxygen, is used to densify biomass fuels. Pyrolysis, which operates at a higher temperature, also without oxygen, produces fuel oil and char products that are analogous to fossil-origin oil and coal. However, the quality of these products is inferior to those from fossil sources. Gasification, with temperature and oxygen conditions in between those of pyrolysis and incineration, is more technologically complex. The gas product can be burnt very efficiently, but the overall efficiency is still comparable to that of incineration ([Section 8.3.4](#)). The gas can also be purified into a syngas fuel or used as a feedstock for other chemical processes. Commercially successful examples of waste pyrolysis and gasification are uncommon.

Most mainly organic wastes contain a small proportion of incombustible minerals. After incineration, this remains as ash. In gasification, pyrolysis or torrefaction, the mineral fraction is initially associated with the organic char but also remains as mineral ash if the char is used as a fuel. Management options for the ash depend on its composition, which in turn depends on the original organic waste. For example, ash from untreated wood waste from a sawmill is high in potassium and phosphorus. Since these are essential nutrients for plants, the ash may be useful as a fertiliser. But ash from construction timber that was pressure-treated to prevent rotting will also contain copper and arsenic. Since these are toxic elements, this ash cannot be applied to land without further treatment. Management of ash from plants that recover energy from MSW is further discussed in [Section 8.3.6](#).

## **6.8 SUMMARY**

Waste collection and treatment systems have evolved in response to local impacts of uncontrolled waste discarding. Household wastes are generally managed by local governments, whereas commercial and industrial wastes are managed under private contracts. Since materials with high purity make the best feedstocks for recycling, good collection practices, including source-separation of materials, are important for material recovery at a high value.

Wastes can have a wide variety of characteristics, depending on their origins, which must be considered in the planning of waste collection and treatment. Contaminants in wastes include substances or materials that interfere with recovery processes, or that pose a hazard to human health or the environment. Treatment of wastes to reduce contamination by separating them out for destruction or recovery can be achieved using physical, physicochemical, biological or thermal processes.

Physical processing includes storage arrangements, size-reduction of solids, and mixing and separation. Physicochemical treatment includes the separation of substances from solids by washing or leaching with water, solutions, or other liquids. Chemical reactions such as oxidation, reduction and neutralisation can destroy contaminants or change them to a form that can be more easily removed. Substances may be removed from gases or liquids by adsorption, ion exchange, precipitation, and coagulation and flocculation.

Biological treatment uses aerobic or anaerobic micro-organisms to decompose organic components of waste. Supply of oxygen is fundamental to aerobic waste treatment and is achieved in different types of reactors, either by bubbling air through a liquid containing the organic matter, or by providing a surface for biofilm to grow, open to the atmosphere. Aerobic composting of solid biomass requires the provision of air and moisture. In contrast, oxygen must be excluded from reactors used for anaerobic treatments, such as anaerobic digestion, denitrification and biological phosphorus removal.

Thermal treatment applies a temperature change to remove or destroy components of the waste. Heating can remove water or other volatile organic compounds from solids or liquids; freezing can separate components from water. Thermal destruction processes include disinfection to kill pathogens and catalytic oxidation of contaminants. Torrefaction, pyrolysis, gasification and combustion (including incineration and coprocessing) use high temperatures and oxygen to partially or fully destroy organic components of waste by oxidation, with recovery of solid, liquid, and/or gas fuels, or energy.

## **6.9 REVIEW**

- 1.** Which institution is usually responsible for the collection of waste and why is this the case?
- 2.** What kind of containers and vehicles are used to collect household waste, and what are their important features? What other features are needed for the collection of industrial wastes?
- 3.** What is meant by 'source-separation' and why is it often a key part of waste management plans, whether for municipalities or industries?
- 4.** What happens to wastes after they are collected?

5. What are some of the issues to consider in the design of waste storage facilities?
6. Why may it be necessary to treat wastes?
7. What are the goals of physical, physicochemical, biological and thermal treatment?
8. What technologies are available for the physical, physicochemical, biological or thermal treatment of wastes?
9. What are the operating principles and typical applications of these different technologies?

# 7

# WASTE RECYCLING

## LEARNING OBJECTIVES

After studying this chapter, you should be able to:

- explain the purpose, concept and types of recycling
- explain the recycling process for metals, plastics and paper
- list recycling steps for other materials and products
- evaluate the challenges and limitations of recycling
- critically reflect on the benefits of recycling practices



## 7.1 INTRODUCTION

Recycling, also called material recovery, is the use of waste to make new materials and products. For example, discarded newspapers can be collected from street bins, separated from other waste, pulped in a paper mill and turned into newspapers again. Widely recycled materials include metals, paper, plastics and glass. Waste that is collected and treated for recycling becomes a secondary feedstock and is often cheaper than primary (virgin) feedstock. This makes recycling attractive from an economic standpoint.

Recycling helps conserve resources because it cuts out virgin extraction; a newspaper from recycled fibre does not require trees. Recycling can reduce the impacts of industrial production on the environment and human health because the processing of secondary resources is often less energy-intensive than the processing of primary resources. For example, smelting steel scrap requires less energy than turning iron ore into steel. Besides, recovering a material instead of disposing of it in landfill reduces the land requirements and other impacts of landfills.

With closed-loop recycling, waste is used for its original purpose, for example, melting steel girders upon demolition of a building and turning them into new steel girders. With open-loop recycling, the waste is used for a different purpose. For example, plastic PET bottles are more often recycled into textile fibres than new PET bottles because of the strict quality requirements for bottles. Recycling does not include the use of waste for generating energy, which is called energy recovery and is discussed in the [next chapter](#).

This chapter explains the concept, measurement, benefits and limitations of recycling, and discusses the purpose and process of recycling for major material categories and products. The chapter looks in detail at the recycling processes of steel, plastics and paper – including the relevant collection practices and

treatments discussed in the [previous chapter](#) – and reflects on the benefits and challenges. It also covers the use of compost and digestate and other forms of organic waste recycling, and briefly discusses the recycling of textiles and glass. The final section is about low-grade recycling options.

## 7.2 RECYCLING OVERVIEW

### 7.2.1 The concept of recycling

Recycling is the reprocessing of waste into a feedstock for making new materials and products. In [Figure 1.3](#), recycling is represented by the arrows that go from ‘Treatment and recovery’ and ‘Manufacturing’ back to ‘Production’. Recycling is different from reuse, which does not require reprocessing in production facilities (in [Figure 1.3](#), reuse is shown by the arrow that goes back to ‘Use’). Recycling – as defined in this book – includes managed decomposition of organic materials, notably composting and anaerobic digestion.



**Figure 7.1 Source-separation is not another word for recycling; source-separation is only a potential first step in the recycling process.** Image: blickpixel.

Many people refer to ‘recycling’ when talking about the source-separation of waste ([Figure 7.1](#)). Recycling is much more than source-separation; it is a sequence of processes that may begin with source-separation, or with mixed waste collection, followed by initial or further separation and cleaning, and

subsequent reprocessing and use as a feedstock in material production and product manufacturing. More specifically, recycling consists of:

- collection of recyclables from production, manufacturing or after use, as separate (e.g., cardboard, glass, metals) or mixed waste streams
- separation of recyclables from nonrecyclable waste and into desired fractions (e.g., separate bales of PET bottles and multilayer cartons)
- cleaning and processing of separated recyclables into a workable form, such as liquid plastic
- processing into a secondary feedstock, such as plastic pellets, which can be directly used to make new products

The secondary material tends to be degraded and contain more impurities than the primary equivalent. To ensure sufficient quality, the secondary material is often mixed with primary material. For example, legal limits may constrain the recycled content of plastic bottles because of the risk of migration of contaminants into the drink. Adding virgin plastic reduces the concentration of contaminations in the plastics and limits the risk of the leaching of chemicals into the beverage.

Many recycling efforts are driven by cost-saving. The economic benefits of recycling are potential savings in landfill costs for waste managers (when landfill fees exceed the net cost of waste separation) and potential savings in the material costs of producers (when secondary materials are cheaper than virgin materials). The positive environmental image of recycling can also have a positive impact on prices and sales when consumers are environmentally minded.

A distinction is sometimes made between pre-consumer and post-consumer recycling. Post-consumer recycling refers to recycling of end-of-life waste generated by consumers. Pre-consumer recycling refers to waste that is generated in the supply chain of the product, such as the waste from a facility that cuts and prints magazines. Pre-consumer waste excludes waste from industrial processes that can process their own waste, such as wastepaper from recycled pulping. Relatedly, pre-consumer waste is sometimes called post-industrial waste.

### 7.2.2 Measuring recycling

Recycling activity is commonly tracked by governments and industry associations and published in the form of recycling rates. The rates are commonly specified by waste stream and geography, such as cities, countries or country groups. [Figure 7.2](#) shows the recycling rates for the most widely used packaging materials in the United States. In 2017, packaging waste made up about 30 per cent of MSW in the United States. Like most recycling rates, the rates were calculated by dividing the waste that was available for recycling by the total waste generation.

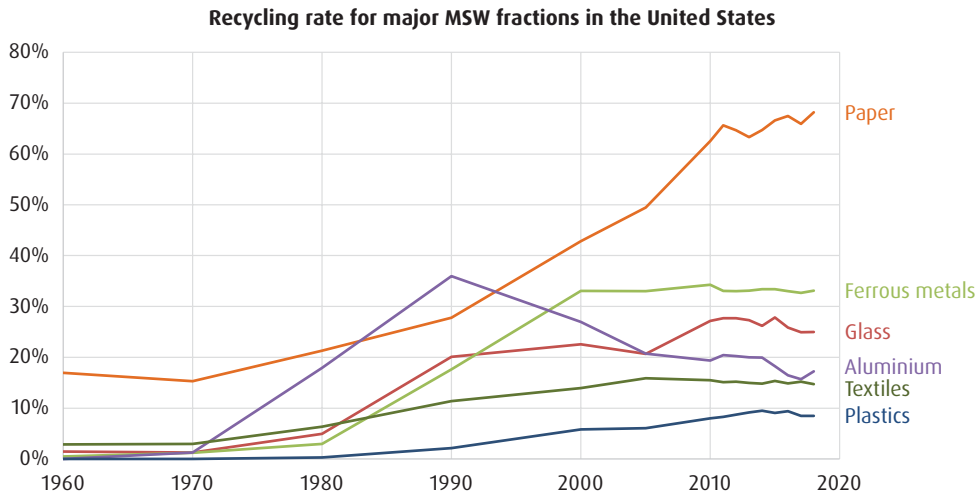

**Figure 7.2 Recycling rates for packaging materials in the United States.** Data taken from US EPA (2020).

Figure 7.2 raises questions regarding which materials were counted as ‘recycled’. All waste in recycling bins? Or just the recyclable outputs from sorting facilities? Or just the amount of secondary material, such as recycled plastic granules? The data for the figure was estimated by the US EPA from a separate set of references for each material. These sources tend to record recycling as the materials traded between sorting and reprocessing facilities, but there is no standardised formal method. Moreover, the charts are for MSW only and exclude similar waste from industrial sources.

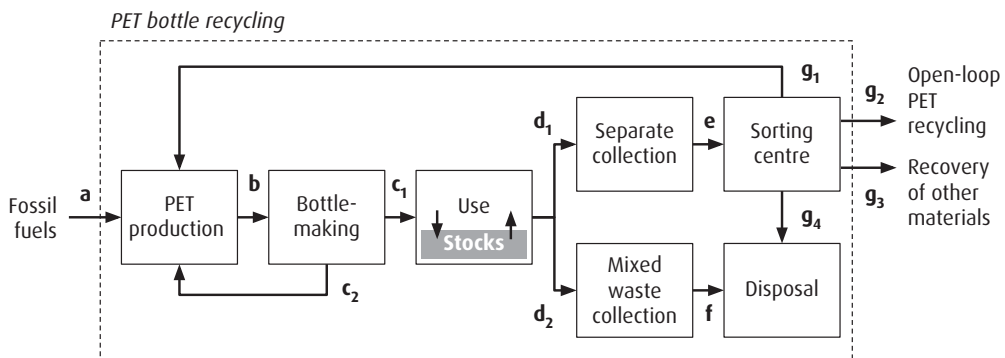

**Figure 7.3 A process diagram of the PET bottle recycling system.** Adapted from Haupt, Vadenbo and Hellweg (2017).

Figure 7.3 shows the many flows relevant to the recycling of a single product: PET bottles. It includes closed-loop recycling and open-loop recycling into textile fibres. While a simplification of reality, the diagram features no less than a dozen material flows (ignoring additions and removals from stocks in the use-phase). Since all these flows are directly or indirectly relevant to the overall recycling performance, recycling performance can be measured in various ways. In the exercise below, you can explore the recycling performance metrics for the PET bottle recycling system.

### EXERCISE 7.1 CHOOSING RECYCLING METRICS

Figure 7.3 shows the recycling system for PET bottles. The separate collection rate can be calculated by dividing  $d_1$  by the sum of  $d_1$  and  $d_2$ . Identify the equations for calculating: 1) the fraction of sorted recyclables that are used for open-loop recycling; 2) the fraction of waste that is used for closed-loop recycling; 3) the fraction of recycled inputs in total inputs for bottle production (the recycled input rate). Compare your approach with someone else; did you come up with different equations? If you are working on this alone, how else could you have calculated the metrics? What is the role of pre-consumer and post-consumer recycling in your metrics? In your opinion, which metric reflects recycling performance best? Why?

In the exercise, we did not use actual figures. A study for Switzerland (Haupt, Vadenbo and Hellweg 2017) revealed that the different recycling performance metrics yield very different scores. For PET bottles, the study presented the following metrics.

- The collection rate for PET bottles was 85 per cent.
- The recycling rate – the waste that was actually recycled and not removed as a nonrecyclable contaminant – was 68 per cent and included 5-percentage-point recycling of other materials (other recyclables in the PET bottle waste stream).
- The closed-loop recycling rate – the recycling rate for bottles that are turned into bottles – was just 26 per cent.

The recycled input rate – the fraction of inputs into plastic bottle production that is recycled – was not calculated because it requires an analysis that includes cross-border trade and PET production and consumption outside of Switzerland.

### 7.2.3 The benefits of recycling

The main environmental benefit of recycling is a reduction in the extraction of primary resources and their processing, which conserves resources and often reduces the environmental impacts associated with processing. [Figure 7.4](#) shows estimates of the GHG savings per tonne of material for the United States. There are four categories of GHG savings.

- Process energy may be reduced because it often requires less energy to process secondary resources than primary resources.
- Transport emissions may be reduced when secondary resources are available at shorter distances than primary resources.
- Process nonenergy emissions may be reduced when primary resource processing generates GHG emissions that are not from burning fossil fuels but are directly created in industrial processes, such as lime production from limestone.
- Forest carbon storage may reduce emissions (through an increased uptake of carbon in photosynthesis) when recycling leads to fewer trees being taken from forests, protecting the forest carbon stock.

According to [Figure 7.4](#), GHG savings should be expected for all the materials included in the chart. Only in some cases does recycling yield higher emissions for selected emissions sources, such as for transport emissions for PET. For most materials, the largest GHG reductions occur because secondary processing requires less energy, but for paper and fibreboard almost all savings derive from forest carbon storage (i.e., recycling is saving trees). Aluminium recycling has high savings for process nonenergy emissions because primary resource processing requires lime.

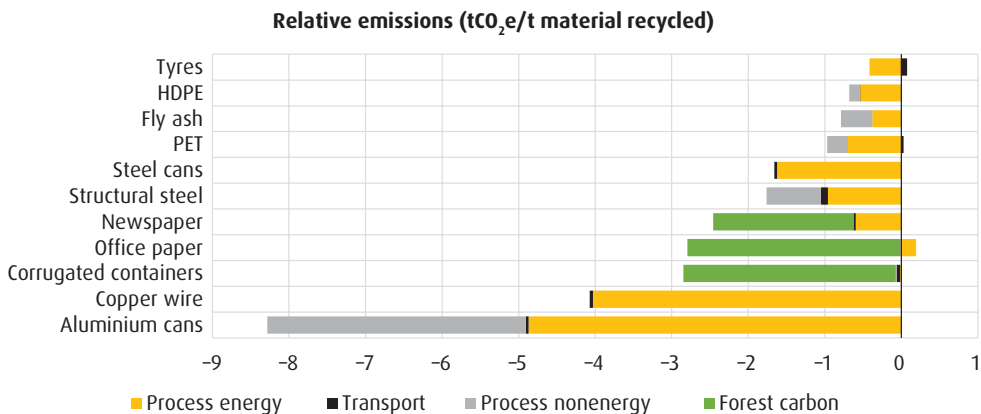

**Figure 7.4 Relative emissions from recycling in the US. Negative values show emissions savings through increased recycling.** Data taken from US EPA (2015).

As you already know, lifecycle evidence must be interpreted carefully, and this is also true for the data in [Figure 7.4](#). First, the estimates are for the United States only. In other countries, production technology may be quite different, and poor forest management could lead to an altogether different impact of paper recycling on forest carbon. Second, the evidence only pertains to savings – the graph does not reveal which recycling processes are least energy-intensive because it only shows the difference with the emissions from the production of primary feedstocks.

The environmental benefits of recycling critically depend on the extent to which it displaces primary material production, so the following must be kept in mind:

- Secondary feedstocks can rarely fully substitute primary feedstocks. Often, at least some primary (raw) material needs to be mixed in to ensure sufficient product quality. This means that the actual benefits of recycling are somewhat lessened. For example, when recycling aluminium cans, a small amount of primary material is added to improve their composition. For food-grade plastic packaging, regulations stipulate a maximum amount of secondary material to prevent migration of contaminants into the food.
- Closed-loop recycling tends to be more beneficial than open-loop recycling because it substitutes the original primary feedstock, potentially multiple times, rather than a different type of material. For example, the production of fibreboard is less energy-intensive than the production of paper, which means that open-loop recycling of wastepaper into fibreboard does not save as much energy as closed-loop recycling of paper into paper.
- Some materials can be made from various secondary feedstocks, meaning substitution could take place between wastes. For example, for the production of insulation material, a manufacturer could choose between cullet (waste glass) and wastepaper. Whichever material is chosen, substitution would be taking place between two wastes, and not between waste and a primary feedstock.
- A recycled material from one country may substitute primary feedstocks from another country, which can strongly affect the comparative environmental benefits due to differences in production technology. For example, if country A uses a lot of energy to produce steel, and country B uses very little energy to produce the same steel, the recycling of steel from country A in country B has smaller benefits than the recycling of steel from country A in country A.

Finally, recycling may reduce one environmental impact but increase another ([Figure 7.4](#) only covers climate change). Sometimes, recycling saves energy but requires more water or chemicals than primary processing, or more transport. An LCA is required to show the benefits of recycling of specific materials in specific contexts, or to show which conditions must be fulfilled to ensure that recycling is overall beneficial to the environment.

## 7.2.4 The imperfect circle

Recycling of secondary resources often has clear environmental benefits compared to primary feedstock production; it may require less energy, create fewer harmful pollutants, conserve natural resources and reduce waste-to-landfill. However, recycling cannot create a perfectly circular system, for at least the following reasons.

- Recycling at a high quality requires energy, and the higher the quality that is demanded, the more energy is needed. The more you recycle, the higher the energy demands per unit of recycling, until it becomes unfeasible to recycle more (see also [Box 7.1](#)).
- Circulation of materials is possible only when materials are not locked into in-use stocks such as infrastructure and buildings. Since the bulk of materials is used for an extended period of time, additional consumption at least partly relies on primary resources.
- Even if materials were not added to stock, inevitable losses during cycling imply a need for additional virgin material. These losses occur because waste is contaminated, and it would take infinite amounts of energy to completely separate all fractions.
- Even if there were no in-use stocks and no processing losses, the growth in demand for products still prevents the loop from being closed. Tomorrow's consumption cannot be met by recycling yesterday's discards when consumption grows over time.
- Fashion and technology change over time, meaning different materials may be needed now than can be recycled from past discards. To make new cars, phones and computers, producers often use newly invented materials that are not yet available through recycling.

While recycling is often better than primary production, it still requires substantial amounts of energy and causes a lot of emissions, including in the use-phase of the recycled product. So, even if everything was recycled, production and consumption may not stay within acceptable environmental limits. Instead, recycling has to be part of a larger set of measures that includes waste prevention. [Chapter 9](#) on circular economy will discuss this further.

## 7.3 METAL RECYCLING

### 7.3.1 Metal production

This section, and the next two, explore the recycling of individual material groups, starting with metals. Metals defined the bronze and iron ages; today, more than two thousand years later, they are no less important. We also use quite a few



more. The mostly widely used metal is still iron, commonly combined with carbon to make steel. Besides iron and copper (the main metal in bronze), almost a hundred other metals have been discovered and the majority play an important role in production and consumption. For example, a smartphone contains, among others, iron, gold, silver, tungsten, molybdenum and chromium.

Figure 7.5 shows a generic metal lifecycle. All metals are made from ores, which are first concentrated and then processed to obtain the pure metal. Often the pure metal is mixed again, called alloying, with other metals and nonmetals to obtain the right properties. For example, steel is made from iron ore that is mined, crushed and smelted in a blast furnace or through direct reduction. The iron is alloyed with carbon and a variety of other elements, including manganese, nickel and chromium, to produce steel with different properties for many applications: white goods, cars, cans, buildings and bridges.

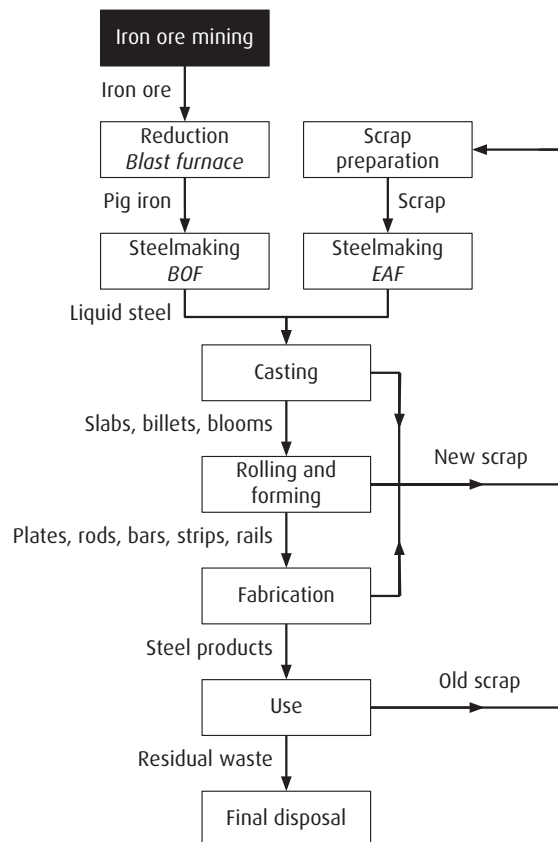

**Figure 7.5 The lifecycle of steel. BOF = basic oxygen furnace; EAF = electric arc furnace.**

Image: Author's own.

All metal deposits are finite; recycling is an important strategy for maximising their use. In theory, all metals can be infinitely recycled. In practice, only some metals are widely recycled. **Figure 7.6** shows the approximate end-of-life recycling rates for 60 metals. The most common metals are recycled at rates of over 50 per cent, including iron (and steel) (Fe), aluminium (Al), copper (Cu) and zinc (Zn). For many other metals, the recycling rate is below 1 per cent. Most of these metals are used in low concentrations in alloys with the more common metals. Do hafnium (Hf) and osmium (Os) sound familiar? They can be found in fountain pens, computers, specialised electronics and nuclear power plants.

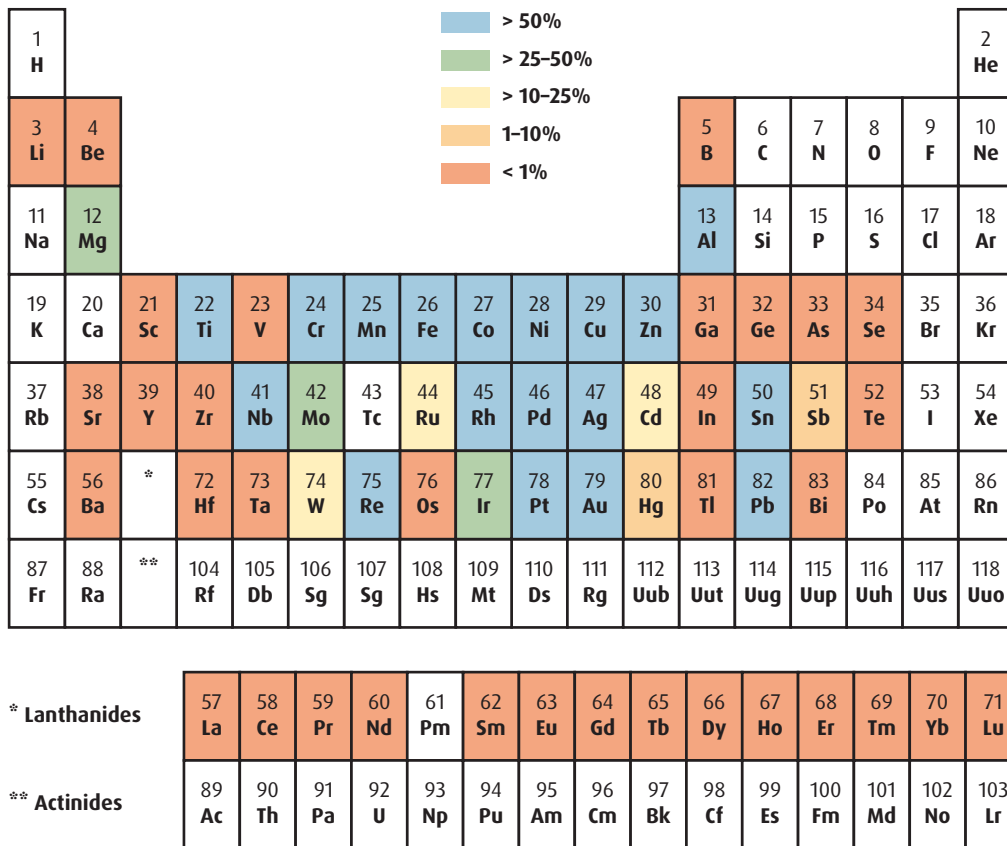

**Figure 7.6 Recycling rates for metals.** Redrawn from UNEP (2011).

### 7.3.2 Recycling process

Metal recycling requires scrap metal, which can be sourced from many stages of the production process and after the use-phase. **Figure 7.7** shows the steel recycling process for end-of-life vehicles. After deregistration, a vehicle is processed at a shredder facility. Here, specific recyclable or hazardous (or both) components are removed, such as batteries, airbags and fuels. The vehicle is then dismantled to remove major components, such as the engine block, before shredding. The bare hull is shredded into small pieces, which are sorted with an air classifier. The sorted metals are separated into ferrous and nonferrous metals and sent to processing plants.

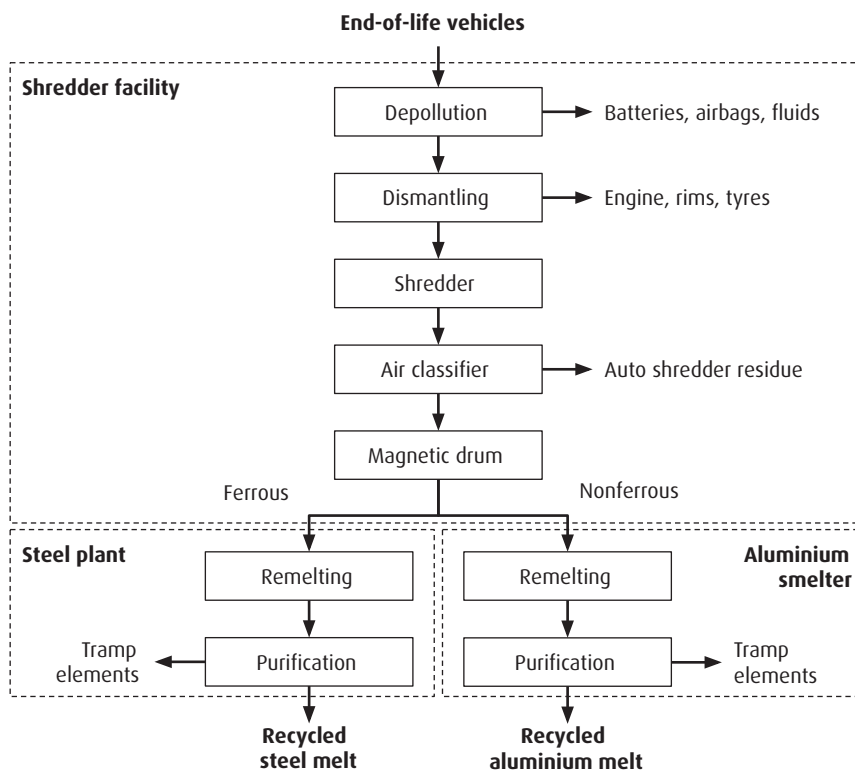

**Figure 7.7** The recycling process for metals in end-of-life vehicles. Excluded are metals other than steel and aluminium, such as copper, which are also common in cars.

Image: Author's own.

At metal processing plants, the steel and aluminium (or other metals found in cars) is remelted and purified. The resulting clean melt can be used for new products, often together with virgin melt to ensure high quality. Many of the steps in the diagram are highly simplified and may be repeated in practice to obtain greater efficiency and decontamination. Many of the fractions that are separated from the metals in the process diagram receive further treatment and may be recovered. The final residue is incinerated or landfilled (see, for example, [Box 7.4](#) on the recycling of car tyres).

A critical step in metal recycling is the removal of tramp elements in the purification step. Tramp elements are small amounts of hard-to-remove metals that negatively affect the functionality of the material. A common tramp element in steel is copper (see [Box 1.3](#)), which restricts the beneficial use of scrap. Besides, steel is often galvanised with zinc, or tin-plated, to protect it from corrosion, and this needs to be undone before recycling the scrap into new steel.

### 7.3.3 Benefits and challenges

Metal recycling cuts out mining, crushing and extraction of ore. As a result, the energy requirements for secondary production tend to be much lower than for primary production. Besides, the avoidance of mining operations prevents a host of environmental problems, from mining waste, to deforestation, to water pollution. Secondary production requires the collection, sorting and decontamination of materials, but these tend to require less energy per unit of output and often have much lower environmental impacts (see also [Box 7.1](#)).

Recycling also responds to concerns over criticality. Critical materials are those that are very important for production while featuring a high risk of a disruption in supply. For example, lithium is critical to the production of batteries for electric cars, which play a major role in addressing climate change by reducing emissions from transport. It is hard to substitute lithium with other materials. At the same time, lithium is produced by only a few countries. Countries that do not produce lithium are highly dependent on producer countries for supplying inputs to car batteries and are vulnerable to restrictions on supply.

Recycling of critical materials can lessen the dependence of consumer countries on suppliers. At high recycling rates, the demand for the virgin product is significantly reduced. An alternative strategy for addressing criticality is the development of substitutes; if a material can be replaced with another material, it is no longer critical to the product. Often, substitution is feasible only between materials that are both critical, which hardly addresses the problem. Another approach to addressing criticality is to expand the number of mining locations and to improve relations between producer and consumer countries.

Figure 7.6 shows that for many metals, recycling is almost nonexistent. Several challenges must be overcome to improve metal recycling. First and foremost, the collection of metals must be increased. This requires the collection and treatment of complex products that often contain only small amounts of metals, such as computers (though the concentration is likely to be higher than in metal ores). Many products currently end up in developing countries, which do not have adequate facilities for metals recycling. An international effort is required to increase and match recycling capacity with waste streams.

Metals recycling can also be increased through improved product design and better recycling technologies. These two go together; we should design products that combine materials in ways that allow separation and cleaning upon discarding. Product designers currently rarely consider the end-of-life phase of products, focusing instead on consumer satisfaction with the product in the use-phase. Much more time and effort go towards the invention of new materials and products than towards the invention of new processes and technologies for recycling. For metals recycling to increase, this must change radically.

### BOX 7.1 IS THERE AN OPTIMAL LEVEL OF RECYCLING?

Recycling cuts out primary resource processing but also requires waste collection, treatment and reprocessing. Most often, recycling takes less energy and has lower environmental impacts than primary processing. But as recycling rates increase, the efforts required to decontaminate the waste streams escalate. To achieve 100-per-cent recycling, an infinite effort would be required to find, collect, clean and reprocess the very last bit of scrap.

Perfect recycling is not feasible, but how close should we get to it? Figure 7.8 shows the energy demand of primary and secondary processing, and the energy demand of production of the final material, as a function of the recycling rate.

- For primary processing, the energy demand per unit of final material decreases with the recycling rate because less primary resource is needed.
- For secondary processing, the energy demand increases disproportionately because it becomes increasingly harder to recycle the materials.

The net cost curve describes the energy demand per unit of final material. It reveals an optimal recycling rate that is below the theoretical maximum of 100 per cent. While we know the optimum must be below 100 per cent, the actual



optimum must be calculated from real data, which is not currently available (the chart only illustrates the relationships).

There is more to consider than the dynamics sketched in [Figure 7.8](#). Over time, virgin extraction becomes harder due to depletion, and more energy will be required to extract a unit of material. Besides, anthropogenic stocks of materials are increasing, potentially making it easier to extract material for recycling. Finally, because of demand growth, stock outflows (discards) tend to be smaller than demand, imposing a practical limit on the level of recycling, possibly below the optimum based on energy use.

The additional concerns are not shown in [Figure 7.8](#). How would you expand the figure to include these additional concerns and recalculate the optimal recycling rate?

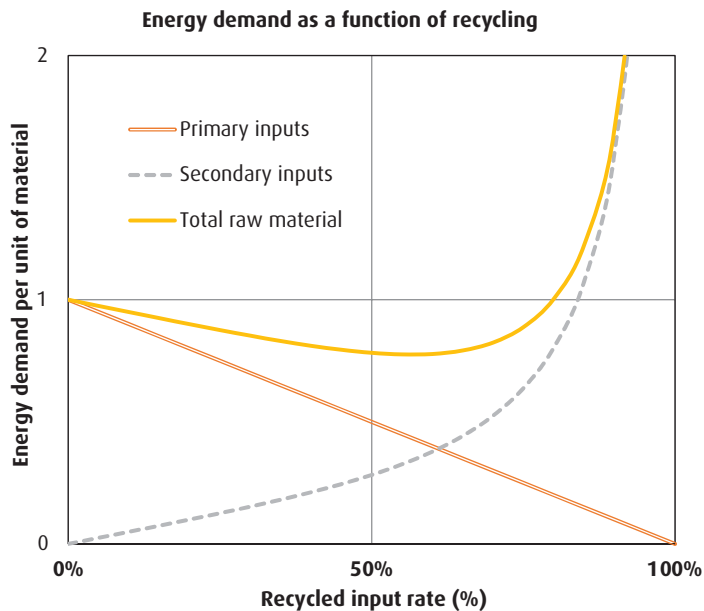
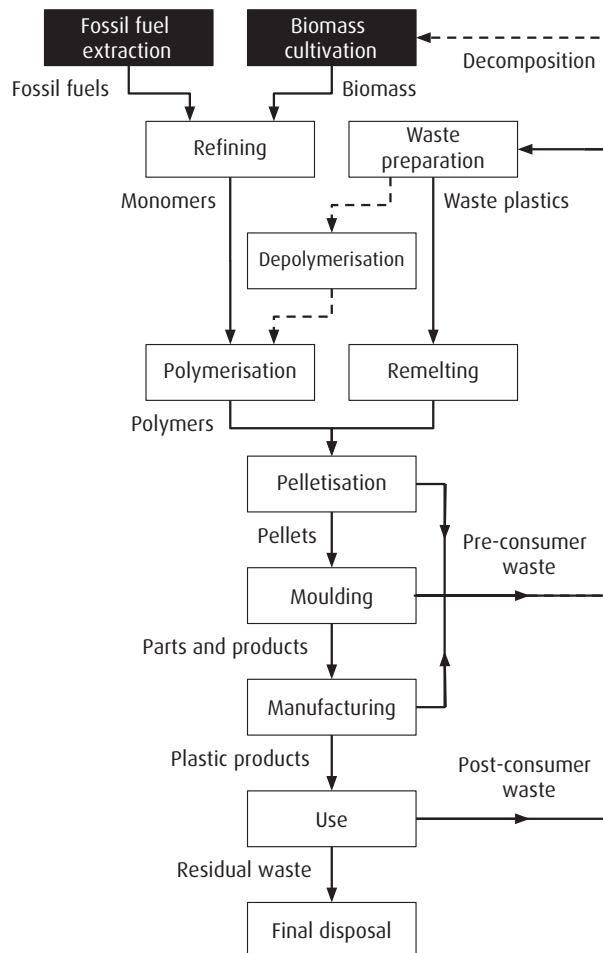

**Figure 7.8** The energy demand of production as a function of the fraction of secondary feedstock in total material input (the recycled input rate). Adapted from Rankin (2011).

## 7.4 PLASTICS RECYCLING

### 7.4.1 Plastics production

Plastics have been around for about a century. Their versatility, pliability and modest cost have revolutionised product design. Unlike many other materials, plastics can be easily moulded into highly complex shapes, which is ideal for consumer products such as electronics. Whereas iron and steel were essential to the industrial revolution, plastics made possible many of the technological achievements of the twentieth century and have shaped many of the products we use today: computers, food packaging, cars, smartphones, window frames and furniture.



**Figure 7.9 The lifecycle of plastics. The dotted arrow shows the chemical recycling process, which is much less common than mechanical recycling through remelting.**

Image: Authors' own.

Most plastics are made from crude oil and other fossil fuels. Some plastics are made from bio-based feedstocks. [Figure 7.9](#) shows the lifecycle of plastics, starting with the refining (distillation) of the fossil fuels or biomass. Refining of fossil fuels can yield many different products, from kerosene to asphalt, and a variety of different plastics are among these products. The distillation process yields small ‘monomer’ molecules that are reacted to form long-chain ‘polymers’.

Some polymers are thermosetting, in which case they harden when heated. Thermosets have ‘set’ during the production process; they are strong and can withstand high temperatures, which makes them attractive for many applications, but they cannot be remelted for recycling. Instead, thermosets combust when heated to a high enough temperature. The first plastic, Bakelite, and the common plastic melamine are examples of thermosets.

More often, polymers are thermoplastic, in which case they melt when heated, and can be recycled that way. Whether in their first or subsequent lifecycle (upon recycling), thermoplastic polymers are made into pellets (granules) and shipped to product manufacturers. The pellets are melted and injected into a mould the shape of, for example, the back panel of your smartphone. When the melt cools and solidifies, a new product is born. Alternatively, the plastic is made into yarns and spun into fibres for textiles.

After use, plastics are collected as waste. The waste may be recycled mechanically or chemically. Since the latter is not common, it is shown with dashed arrows in [Figure 7.9](#). Often, plastic waste is landfilled or burnt for energy recovery (plastic has a high heating value). [Table 7.1](#) gives an overview of thermoplastics based on the numbers used for labelling. On plastic products, this number is shown in a recycling icon, even though only number 1 and 2 are commonly recycled. The table lists typical applications and the recycling rates for the United States. The global recycling rate for plastics is estimated at 14–18 per cent (OECD [2018](#)).

**Table 7.1 Types of thermoplastics, typical applications and the US recycling rate.**

(PlasticsEurope [2017](#); OECD [2018](#); Shen and Worrell [2014](#))

Number	Types of plastics	Typical products	US recycling rates (2014)
1	Polyethylene terephthalate (PET)	Transparent bottles for drinks and cleaning products	19%
2	High-density polyethylene (HDPE)	Milk bottles, toys, household equipment	10%





**Table 7.1 (Cont.)**

Number	Types of plastics	Typical products	US recycling rates (2014)
3	Polyvinyl chloride (PVC), polycarbonate (PC)	Building applications, such as window frames and floors	0%
4	Low-density polyethylene (LDPE), linear low-density polyethylene (LLDPE)	Foils, films and bags for packaging and wrapping	6%
5	Polypropylene (PE)	Food packaging, crates and boxes, caps for bottles	1%
6	Polystyrene (PS), expanded polystyrene (EPS)	Disposable cutlery (PS), fast-food boxes (EPS)	(no data)
7	Other: a large variety of less common plastics	Touchscreens from polymethyl methacrylate (PMMA)	

## 7.4.2 The recycling process

Thermoplastics are recycled in a mechanical recycling process that brings the plastic waste back to a state where the polymer can be melted and moulded into shape again. [Figure 7.10](#) shows the mechanical recycling process for PET bottles, providing more detail than [Figure 7.3](#) of the PET bottle recycling system. The figure starts with separate collection through, for example, a bottle deposit-return system. In such a system, consumers pay a deposit on each bottle, which is returned when they bring the bottle to a collection point, often at a retail location.

After an initial sorting step (which would be much harder for mixed waste), the bottles are baled and sent to a recycler. The recycler washes them and removes the labels. Without the labels, detection during waste sorting is enhanced, and the unwanted types of bottles can be removed, either manually or optically. The bottles are chopped and washed to remove the last residues. Float separation removes plastics with other densities, such as HDPE caps. After rinsing and drying, the recycled PET (rPET) flakes may be pelletised first or used directly for making new plastic products.

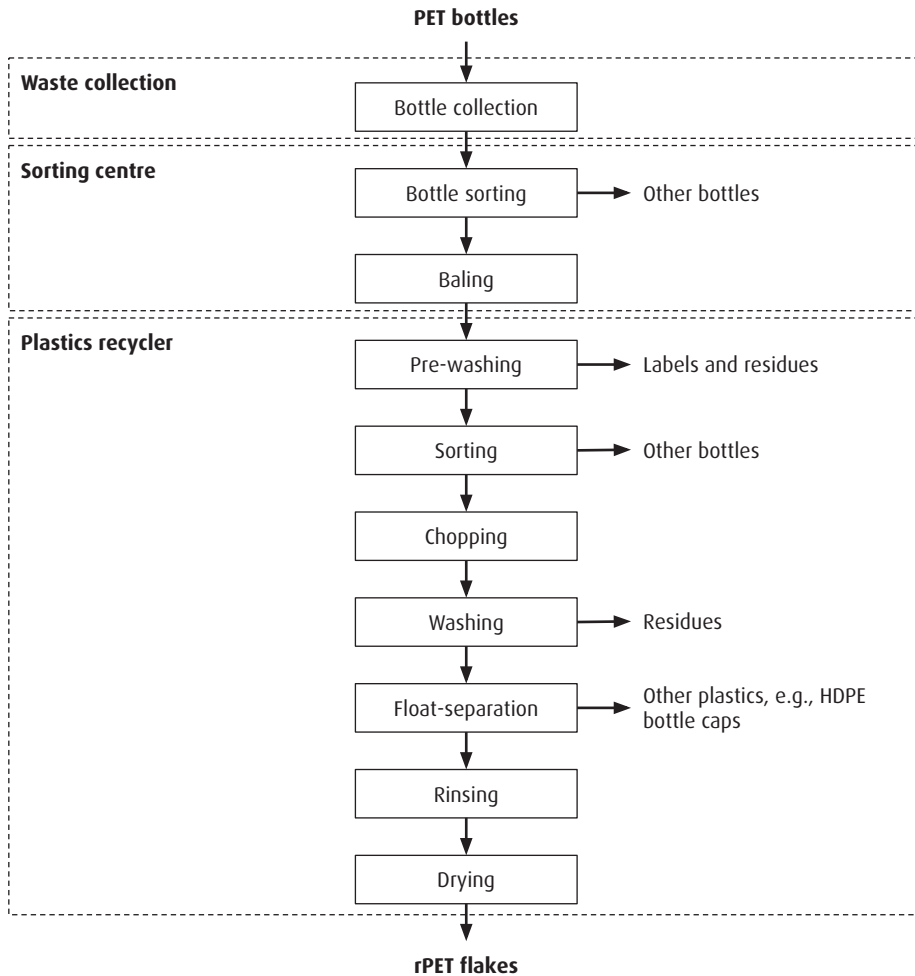

**Figure 7.10 The recycling of separately collected PET bottles.** Adapted from Shen and Worrell (2014).

An alternative technology is chemical recycling (sometimes called advanced recycling, to avoid the negative connotations of the word chemical), which takes plastic waste back to the earliest stages of production by breaking down the polymers to monomers. The monomers can then be polymerised again, just like the monomers from fossil fuel refining (see the route indicated by the dotted arrows in Figure 7.9). Chemical recycling, unlike mechanical recycling, can be applied to any type of plastic. The broken-down polymers can be turned into new plastics, chemicals or fuels.

There is a large variety of chemical process routes to depolymerise plastics, but none of these are widely used at an industrial scale. Most process routes for breaking down the polymers apply thermal treatments in oxygen-starved environments (pyrolysis or gasification; see [Chapter 6](#)), with the help of catalysts. Present chemical recycling is relatively expensive, and many technologies yield fuels rather than materials. Because the large-scale application of chemical recycling is still under development, the practical potential of the technology is still uncertain.

### 7.4.3 Benefits and challenges

Plastic recycling avoids waste to landfill or waste incineration and displaces virgin production of plastics from fossil fuels. Plastics recycling tends to have lower impacts than energy recovery or landfill of plastics. The exact benefits of plastic recycling depend very much on the material and product, since there are many different plastics and plastic recycling routes. Plastics production requires only a few per cent of current global fossil fuel extraction, but this percentage may increase with a decline in the use of fossil fuels for energy in response to climate change.

Various interventions can increase mechanical recycling of plastics. Most of all, improved product design can increase technical recyclability. Recyclers struggle with thin film plastics, products that combine different plastics and product designs that are hard to recognise during sorting. Such issues can largely be avoided through improved design. With more potentially recyclable products on the market, investment in collection and sorting infrastructure becomes more attractive, especially if there is strong demand for products with high recycled content.

Chemical recycling can overcome some of the limitations of mechanical recycling. In theory, it can turn any type of plastic into a new plastic. In practice, most technologies focus on generating fuels. For chemical recycling to become widespread, its cost performance relative to virgin plastics production must improve, which could occur through efficiency improvements or policy interventions (such as a tax on fossil fuels, making chemical recycling relatively cheaper). Besides, the energy required for chemical recycling should be from low-carbon sources.

Plastics recycling does not in itself address the problem of marine litter, which is caused by poor waste collection and the persistence of plastic fragments. Instead, the marine litter problem should be mainly addressed by reducing waste generation and improving waste collection. Besides, the litter that is already in the marine environment may need cleaning up. Indirectly, however, recycling does have a role to play, since well-developed markets for recyclables make it more economically attractive to collect and sort plastics, and perhaps even to collect them from water bodies.

## BOX 7.2 BIO-BASED AND BIODEGRADABLE PLASTICS

Bioplastics are often touted as the solution to the plastics problem. Bioplastics are plastics that are bio-based, biodegradable or both. They include fossil-based plastics that are biodegradable. Figure 7.11 gives an overview of the types of plastics based on feedstock – fossil or bio-based – and biodegradability. Conventional plastics are marked grey; bioplastics are marked green. Only the upper-left quadrant does *not* consist of bioplastics but of conventional plastics (but they are most widely used). Some plastics span two quadrants because they can be made from both fossil and bio-based feedstocks.

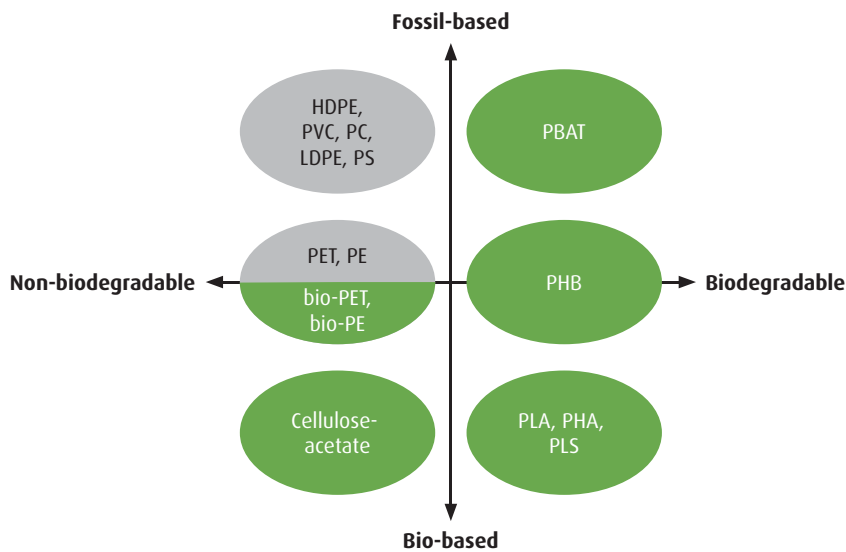

**Figure 7.11 Classification of fossil, bio-based, non-biodegradable and biodegradable plastics.** Image: Authors' own.

All plastics fragment and degrade over time under the influence of UV radiation (in sunlight). Biodegradation is the partial or full breakdown of polymers through microbial activity. There are various standards for assessing biodegradability, based



on the extent of degradation, required time and required conditions, as well as the organic content and possible harm from the resulting compost.

Some plastics can only be degraded in industrial facilities, whereas others are suitable for home composting and may safely degrade in soil and the marine environment. Plastics that easily degrade can also be used in anaerobic digestion (see [Chapter 8](#) for more on this technology). Biodegradable and non-biodegradable plastics share many properties and can be difficult to tell apart when sorting waste. This has caused biodegradable plastics to end up in recycling waste streams and non-biodegradable plastics to end up in composting facilities.

Bio-plastics are no panacea. Bio-based plastics, whether biodegradable or not, can reduce extraction of fossil fuels, but the cultivation of bio-based feedstocks competes with land use for other purposes, including food production. Biodegradable plastics, whether from fossil or bio-based feedstocks, can reduce the environmental problems associated with plastic litter, but biodegradation requires the right conditions, and littered biodegradable plastics, including in the oceans, are by no means guaranteed to decompose.

## 7.5 PAPER RECYCLING

### 7.5.1 Paper production

Paper has a history of well over two thousand years and has been made from a variety of fibrous materials including reeds, cotton, hemp and bark. Today, paper is made almost exclusively from wood. Chemical pulping consists of cooking the wood in a chemical bath, which separates the cellulose fibres from lignin – the sticky material that holds the fibres together. Mechanical pulping separates the fibres by grinding the wood. Semi-chemical pulping combines both approaches. The fibres are then dissolved in water, upon which the slurry can be spread on a screen, pressed and dried.

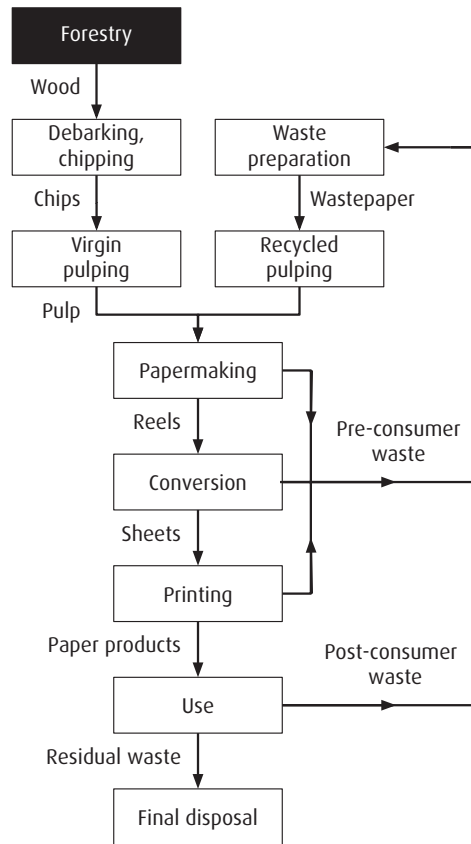

**Figure 7.12 The lifecycle of paper.** Image: Authors' own.

Figure 7.12 displays the lifecycle of primary and secondary paper. The virgin production route includes forestry, mechanical or chemical pulping, and papermaking. In chemical pulping, the lignin that is separated from the cellulose is combusted to generate electricity and heat. In mechanical pulping, both cellulose and lignin are turned into pulp, leading to higher material yield but lower-quality pulp. Pulp is often bleached to make it whiter, then turned into sheets. The sheets are cut to size and printed, depending on the application.

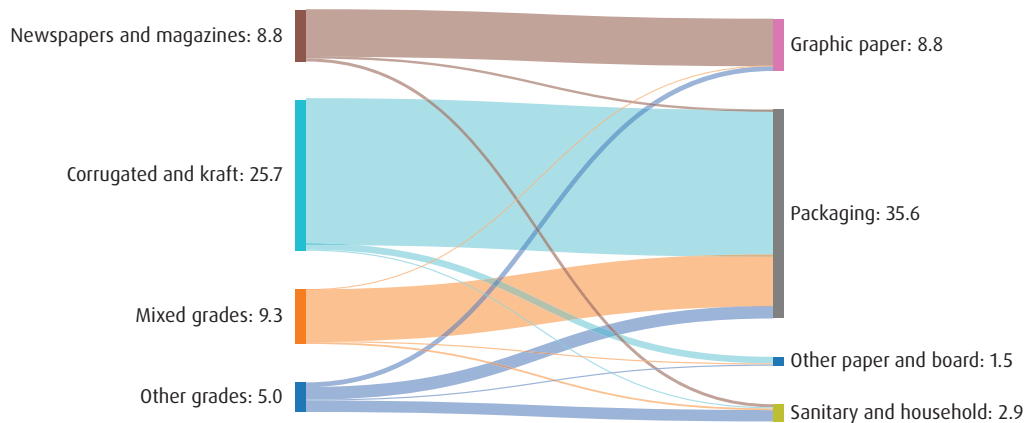

**Figure 7.13 Use of secondary paper (left) in paper products (right) in Europe in 2018.**

Data from CEPI (2019). Visualised at Sankeymatic.com.

The secondary production route consists of pulping of wastepaper. [Figure 7.13](#) shows how wastepaper is used in the European paper sector. Newspaper and high-quality magazine paper are used for graphic paper. Corrugated and kraft paper, typically from discarded packaging, is turned into packaging again. Mixed grades are mostly used for packaging because the quality requirements are lower than for graphic paper. Not shown in the figure is the amount of virgin fibre that must be mixed in to achieve an end product of satisfactory quality.

## 7.5.2 The recycling process

[Figure 7.14](#) shows more detail of the paper recycling process, from the initial input (wastepaper) to the output of recycled pulp. Recycling starts with the collection of recyclables from households, businesses and industries. In many countries, there are separate bins for recyclables, or for paper individually, or for specific paper grades, such as newsprint. Pre-consumer waste from industries in the paper supply chain – for example, printing and publishing – is often the cleanest source of wastepaper. Mixed waste collection from consumers is the most contaminated source of wastepaper.

The collected waste is brought to a sorting plant, where the wastepaper is separated from other recyclables and nonrecyclable fractions. Mixed waste may go to a 'dirty' MRF, which yields paper outputs of low quality, mainly because of contamination with organic (food) waste. The waste from recyclables collection goes to a 'clean' MRF, which yields a higher quantity and quality of paper. Very clean fractions of pre-consumer waste can be delivered directly to the paper mill, without going through a sorting centre.

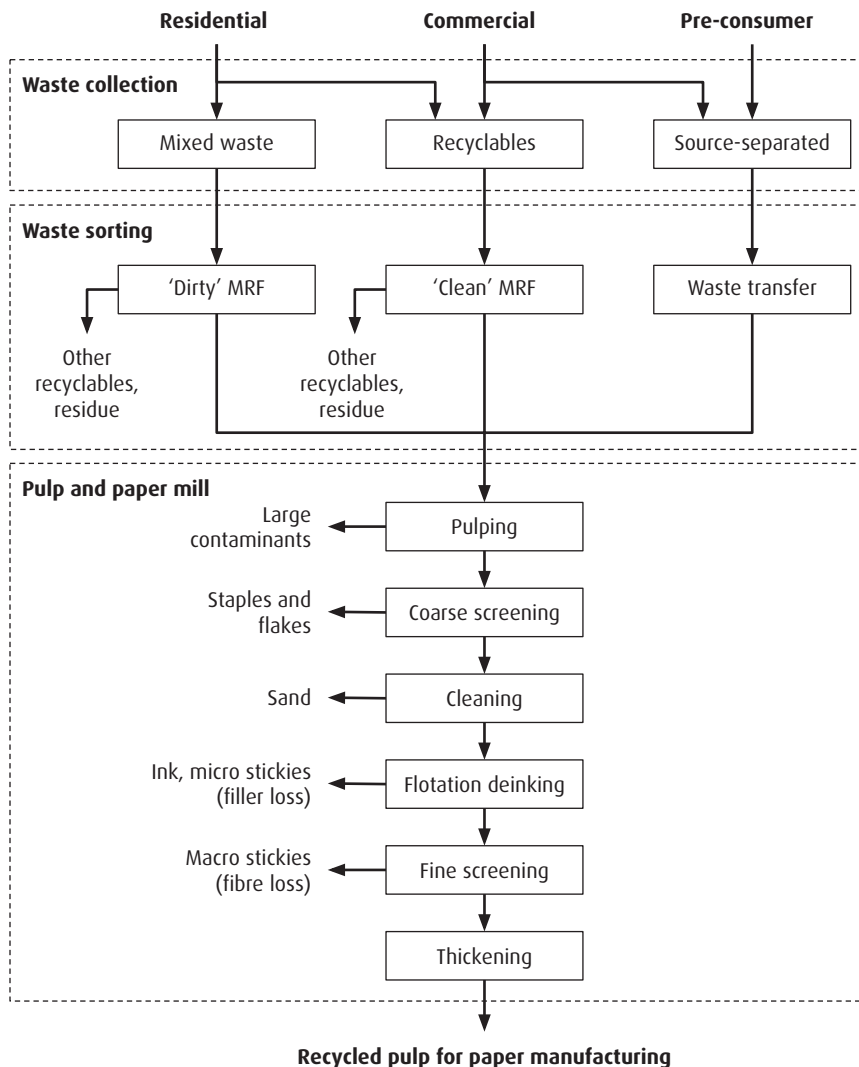

**Figure 7.14** Process diagram of typical paper recycling process from waste generation through to papermaking. Image: Authors' own.



At the mill, further cleaning takes place. First, the wastepaper is pulped to create a homogeneous slurry of fibres in water. This slurry is subjected to several treatments. It is screened to remove coarse items, such as staples, then screened again to remove finer items. In a centrifugal cleaning stage, contaminants including sand are removed by separating low- and high-density contents. The pulp is deinked in a flotation process; it is submerged in a bath with hydrophobic chemicals that adhere to inks, fillers, binders and other non-fibrous material, then float to the surface to form a removable froth.

At each stage, contaminants are removed but also some useful material is lost. The fibres can become stuck in the screens or entrained in the flotation froth. The losses are minimised by careful balancing, sequencing and repetition of the treatments. In any case, there is a trade-off between the cleanliness of the pulp and the amount of pulp that remains after cleaning. The pulp may be bleached for a bright look. Often, the recycled pulp is used together with virgin pulp to achieve acceptable quality, though little or no virgin material is used to produce the lowest-quality paper grades, such as newsprint and case materials (see also [Figure 7.13](#)).

### 7.5.3 Benefits and challenges

The benefits of paper recycling tend to be positive but are highly context-dependent. Recycled pulping requires less energy than virgin pulping, but the associated environmental benefits depend on the energy sources that are used. Chemical pulp mills use the byproduct from pulping to generate heat and power for the mill. The biogenic byproduct is a low-carbon source of energy. Recycling pulp mills do not generate this byproduct and must purchase fuels and electricity. Oftentimes, these fuels are more carbon-intensive than the energy used for chemical pulping.

Recycling reduces the demand for pulpwood, which can have a variety of impacts on forestry, both good and bad.

- When pulpwood demand drives forest degradation and deforestation, and the conversion of ecologically rich old-growth forests into plantations, recycling can reduce these pressures and, therefore, has a positive environmental impact.
- When demand for forest products is high, trees may be used instead for timber or as a fuel, which can beneficially displace more carbon-intensive materials and fuels, which means recycling has an indirect positive environment impact.
- When forestry competes with agriculture, a reduction in pulpwood demand can lead to the conversion of forests into agricultural land, at a loss of biodiversity and carbon stock. In this case, recycling has a negative environmental impact.

The impacts of recycling on forestry thus depend on the market conditions for forestry products and demand for land, and how forests are managed and protected.

The relative benefits of recycling also depend on the use of chemicals in recycled pulping and papermaking. Recycled pulping requires chemicals for cleaning, decontamination and bleaching to make the paper white. Some of these chemicals are also used in virgin paper production, but the more contaminated the feedstock, the more chemicals tend to be required. Recycling, especially at high rates, can increase the number of harmful chemicals that are used. The impact of these chemicals depends in large part on how they are used and disposed of by pulp mills.

Separate collection is essential for high-quality paper recycling. The higher the collection rate, the lower the process yield because many contaminants need to be removed. Paper recycling can be further improved through separate collection of various grades. This reduces the degradation of the recycled fibre mix because it allows selective sourcing for high-quality paper. In many countries, the collection rate of recyclables can still be increased, even more so for separate collection of paper or individual paper grades.

Paper recycling can also be improved by addressing contamination in the design stage of paper products. Fibres can be recycled more often and into higher-quality products if producers phase out harmful or hard-to-remove pigments, fillers and dyes. Besides, some paper is currently not recyclable because it is part of a complex material product, such as paper cups with a plastic lining, which cannot be easily removed in the recycling process. Improved product design and improved sorting technologies can help overcome this challenge.

## **7.6 OTHER MATERIALS AND PRODUCTS**

### **7.6.1 Textiles, glass, cement**

The materials discussed in the previous sections – metals, plastics and paper – are among the most widely used and recycled materials. Other potentially recyclable materials include textiles, glass and cement (in concrete), which are the subject of this section. Rubber is another recyclable; it is further explained in [Box 7.4](#) on tyres.



**Figure 7.15** A textiles collection point in France. The text on the bin emphasises the positive effect on local job creation – every 13 kilograms of textiles supports one hour of labour. Image: Rza3100.

*Textiles* cover a wide range of products that includes clothing, small items (e.g., towels, bed linen), large items (e.g., furniture, carpets), building components (e.g., wall coverings, screens) and industrial applications (e.g., covers, filters). Textiles can be made from natural fibres, for example, cotton, or synthetically derived from fossil fuels, for example, polyester. There are many different natural and synthetic fibres, several of which may be used in a single product, such as a jacket, which means the textiles supply chain is very complex.

Both natural and synthetic fibres may be recycled by cutting up the fabric and using them together with other materials to create new products. Recycling pieces of fabric is similar to component reuse – the material is not fully taken apart. Less commonly, textiles are separated into fibres again through an unravelling process, after which the fibres can be spun into yarn and weaved into new fabric. Some synthetic fibres are remelted and spun into new fibres (mechanical recycling). However, it is more common to source recycled synthetic fibre from PET bottles.

*Glass* is mainly used for containers (bottles, jars, cups) and windows. The material is made from sand, soda ash and limestone, which are transformed into liquid glass in a furnace. The melt is then formed into the desired shape and cooled. Waste glass for recycling, which is called cullet, can be remelted and introduced into the production process. The allowable fraction of cullet depends on the desired quality of the end product, including the colour of the glass (green, brown or transparent), and the extent to which the feedstock can be sorted and cleaned after it has been crushed.

The use of cullet in glassmaking avoids mining and processing of primary resources. It also reduces the environmental impacts of the glassmaking process because remelting of cullet requires less energy than producing glass from primary resources, even though the same types of furnaces can be used. Open-loop recycling options for cullet include the production of beads, glass wool, ceramics, abrasives, filtration media, cement binder and construction products (as aggregate, additive or fillers).

*Cement* is a crucial material in the built environment and provides the binding properties to mortar and concrete. Cement is made through calcination of limestone in a cement kiln, where the cement is subjected to temperatures of about 1,400°C, creating clinker and CO<sub>2</sub> (in addition to the CO<sub>2</sub> from burning fossil fuels). The clinker is mixed with various additives, as well as gypsum, to create a cement with the right properties. The cement can then be mixed with sand and stone-like materials (aggregate) and water to create concrete. The cement fraction is typically 10–15 per cent.

The recycling of concrete is often limited to grinding the material for use as secondary aggregate, without restoring the original binding properties of the cement, but only using the volume, density and strength of the material. Thus, recycling concrete into concrete requires the addition of new cement. At the same time, the production of cement can include the use of waste materials with binding properties, such as fly ash from coal combustion. Besides, waste can be burnt in the kiln, with the ash becoming part of the clinker. [Box 3.2](#) highlights the role of cement production in material recovery.

## 7.6.2 Complex products

Recycling often starts with the collection of multi-material products. [Section 7.3](#) on metals already highlighted metal recycling from end-of-life vehicles, which are a source of many different recyclables: metals, glass, plastics and rubber. Besides, some car components are complex products in themselves, such as batteries, which is particularly relevant for hybrid and electric vehicles. The recycling of complex multi-material products requires a dedicated collection and treatment infrastructure and product design that considers the recyclability of the product after discarding.

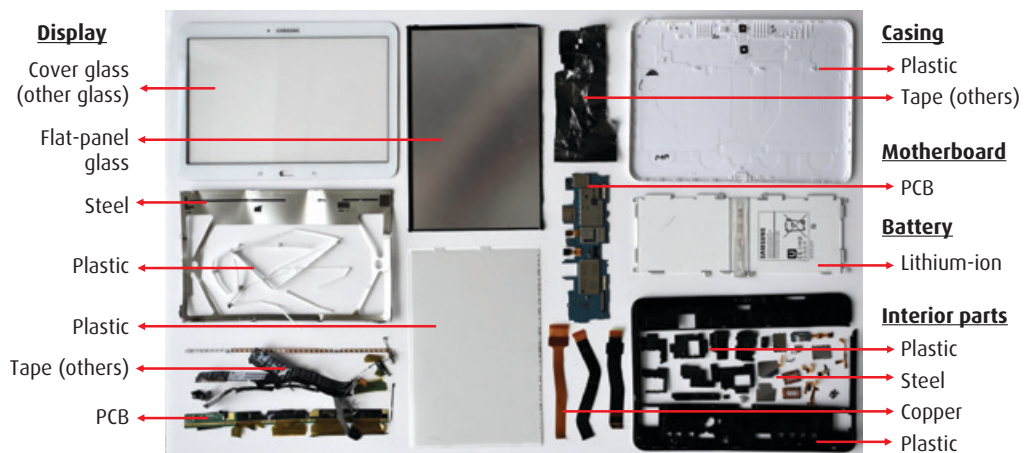

**Figure 7.16** The components of the Samsung Galaxy Tab 4 tablet and their material composition. Image: Babbitt et al. (2020).

An example of a complex product is a tablet. [Figure 7.16](#) shows what a tablet looks like when it is taken apart. The main components are the display, casing, motherboard, battery and interior parts. The components are made from glass and a large variety of metals and plastics. [Table 7.2](#) quantifies the material contents of the product. The largest mass fractions by material are plastic and the lithium-ion battery. However, the table does not represent the full complexity of the product; the plastics in a smartphone are of a variety of types, and the battery contains various different metals.

**Table 7.2** Material content of the tablet shown in Figure 7.16. Babbitt et al. (2020).

Material	Material and mass (g) breakdown by component					Total material mass
	Casing	Display	Battery	Interior parts	Motherboard	
Aluminium						
Copper				2.2		2.2
Steel		20.0	0.3	6.1		26.4
Plastic	65.0	43.5		41.3		149.8
Lithium-ion battery			125.0			125.0
PCB		7.3		2.4	26.2	35.9
Flat-panel glass		60.0				60.0
CRT glass						
Other glass		90.0				90.0
Other metals						
Others	1.0	1.4		0.2		2.6
Total component mass	66.0	222.2	125.3	52.2	26.2	491.9

Many countries have separate collection infrastructure for end-of-life vehicles, waste electric and electronic equipment (WEEE), lamps and batteries. This reduces the need for post-collection effort and prevents hazardous materials, such as the contents of batteries, from contaminating the recyclables in a mixed stream. However, having separate recycling systems is far from sufficient to achieve high recycling rates. Many of the materials in complex products cannot be recovered because the technology is not available or because it is not economically feasible.

Instead, recycling systems depend on good product design. Design for recycling is the design of products that enables disassembly and subsequent material recovery. Design for recycling requires excellent communication between product designers and recyclers, and product-specific agreements regarding material choice and assembly. Policy measures such as general ecodesign rules and extended producer responsibility are intended to stimulate such engagement between designer and recyclers (Chapter 5).

## EXERCISE 7.2 RECYCLING SMARTPHONES

Smartphones contain many valuable materials, include rare-earth metals, but they are notoriously difficult to recycle due to the complexity of the product. Besides, many people do not discard their old smartphone but store it away. How can we make these hibernating stocks of smartphones available to recyclers, and what interventions could ensure the recyclers can effectively take the smartphones apart and recover the individual materials? What roles do you envision for product designers, waste managers and policymakers?

### 7.6.3 Organic waste

Organic waste includes food waste, agricultural waste, garden waste and wood waste (and paper, which was already discussed in [Section 7.5](#)). Here, we first discuss recycling of wood. Wood combines a wide range of properties; it can decompose, just like food and garden waste, but it is also a durable material with great structural qualities. The recycling of wood can therefore take many different forms. Below is a list of applications, starting with those that may be called reuse instead of recycling because they require a minimal amount of reprocessing and leave the waste largely intact.

- *Structural*. Well-preserved timber from construction and demolition can be used again for similar construction applications (see also [Box 7.3](#)).
- *Flooring*. Timber can be processed into flooring and panelling, which typically does not require large pieces. Reprocessing could be minimal or extensive.
- *Pallets*. Pallets do not require high-quality wood or finishing, so they can be made from waste wood. Damaged pallets can be combined to make new ones.
- *Board*. Wood can be processed into chips and fibres, which can be used to make various qualities of board, such as medium-density fibreboard.
- *Mulch, chips, sawdust*. Wood can be turned into mulch, chips or sawdust, which can be used in gardening, as a bulking agent (absorbing water in slurries) or in animal bedding.



A major challenge to wood recycling (and also to energy recovery from wood) is the presence of contaminants in treated and painted wood, including hazardous substances. A major opportunity for wood recycling is carbon storage. Sustainably sourced wood represents a removal of CO<sub>2</sub> from the atmosphere for as long as it is kept intact. The recycling of wood waste thus potentially contributes to climate change mitigation. It also avoids waste to landfill and may have substitution benefits when it displaces high-impact materials such as steel.

For organic waste other than wood waste, the key property is degradability. Organic waste naturally decomposes, and the process can be sped up through mechanical treatment (to reduce particle size), composting (to optimise temperature) and anaerobic digestion (to maximise biogas generation) (Chapter 6). Composting and anaerobic digestion both yield soil-like materials, compost and digestate, respectively, that can be recycled. Digestate is a slurry that can be separated into a fibrous and a liquor fraction.

Compost and digestate can be recycled in a range of applications for improving soils and surfaces. Often, the material is used in a mixture with other materials, such as aggregate or natural soil, to achieve a specific set of benefits appropriate to the application. Compost and digestate can supply nutrients, including nitrogen, phosphate and potash. Besides, they can improve soil acidity, soil aeration, root penetration, resistance to wind erosion, water-holding and drainage capacity, nutrient-holding capacity and resistance to weed growth.

The use of compost and digestate can reduce demand for other materials, such as mined fertilisers, virgin soil material, peat and pesticides. Another advantage of composting and digestion is the reduction of organic waste to landfill, where it would have generated methane. However, the beneficial use of organic waste requires a careful approach to waste selection, sorting, treatment and application. Variations in the waste stream and the differences between applications, such as the existent soil quality, mean that the benefits depend on how the waste is used.

Organic waste can also be used as animal feed. It is common practice to process residues from food production, such as fruit peels and corn husks, into animal feed. It is much more challenging to process the mixed food waste from retailers, hospitality and consumers into animal feed because of the risk of contamination with packaging and the potential presence of microbial pathogens. Besides, most animals are not omnivores and benefit from a restricted diet, which can be hard to obtain from a mixed waste stream.



### BOX 7.3 DOUBLING DOWN ON TIMBER

Timber has a long history as a construction material for low-rise buildings. It is currently being rediscovered as a potentially sustainable alternative to concrete and steel in large buildings.

Regular timber is not strong enough for tall buildings, but cross-laminated timber (CLT) offers the desired performance through multiple layers of timber glued in a single board. The potential advantages of CLT are many. It saves carbon, simplifies construction with prefabricated sheets and can look very attractive. It also insulates well and offers good fire protection due to its density and thickness (it chars rather than burns).



**Figure 7.17** This tower in Norway is one of the tallest structures in the world made with CLT. Image: Øyvind Holmstad.

Even better than CLT might be CLT that is not made from trees but from waste wood. Cross-laminated secondary timber (CLST) has the advantages of CLT but the



additional environmental benefit of the avoidance of disposal and lower pressures on forests.

Unfortunately, the performance of secondary timber is much less consistent than virgin timber, which means CLST requires a very careful and sophisticated approach to material selection and design. For example, secondary timber often features holes from nails, screws and bolts; too many of these can weaken the CLST product.

Early investigations find that CLST is feasible but requires a tailored approach. This approach echoes concerns that are common for recycling; the materials need to be prepared very carefully with consideration of their variable quality, the sorting and treatment will induce some losses (e.g., various pieces may be deemed unsuitable) and for specific applications it may be better to combine secondary and virgin timber in a single product.

Source: Rose et al. (2018).

#### 7.6.4 Low-grade recycling

Mixed or low-quality waste can be recycled in a range of applications that only demand minimal functionality of the material, such as low heat conductivity (for insulation material) or appropriate particle size (for soil improvement). Example waste materials include ash, sludge, aggregate, rejects – some of these are partly or wholly organic. Below is a list of mixed waste recycling operations, all of which are open-loop downcycling operations, and in many ways very different from the more well-known recycling practices discussed in the earlier sections of this chapter.

- *Soil improver.* Waste can be mixed with soil to increase stability or drainage, for example, for construction projects. This is a low-quality application and mostly requires waste with the right particle size. The waste should also be clean enough to avoid soil and water contamination. An example is the use of dried sludge in groundworks.
- *Neutraliser.* Acidic substances, such as wastewater from mines, can be treated with alkaline waste, such as lime residues from pulp mills (a waste generated in the chemical pulping process). This practice reduces the environmental impact of the mine waste. For various applications of neutralising agents, see [Chapter 6](#).
- *Aggregate.* Aggregate is bulk material used in, among others, road surfacing and concrete production. Sand and stone-like wastes can be used for this purpose, provided they are not too contaminated. Some contamination may be allowed because the contaminants are trapped in the road surface or concrete structure.

- *Admixture*. Some waste has properties that are useful in the production of cement. They can be coprocessed (burnt) in cement kilns that turn limestone into cement; the ash (including unburnt material) becomes part of the cement and reduces the need for limestone.
- *Filler*. Many materials contain some fraction of fillers that may or may not improve the material properties, but at least provide volume, as well as a lower cost of production. For example, hard-to-recycle fibres can be used to fill fibreboard.
- *Adsorbent*. Waste that easily adsorbs other materials can be used in wastewater cleaning. It reduces the need for primary adsorbents, but it immediately creates a new compound waste that must be disposed: waste with further waste adsorbed to it.
- *Landscaping*. Sometimes, waste is used as bulk material for landscaping. This constitutes recovery when it displaces primary materials but should be considered disposal if it is pursued only to get rid of the waste cheaply.
- *Landfill cover*. Landfills need temporary (during operation) and permanent (after closure) covers to keep the waste in place. High-density waste that is not washed or blown away can be used for this. A needlessly thick landfill cover is just disposal in disguise.

We included various critical notes in the list above because many forms of nonrecycling material recovery relate to applications of low quality and value, substitute primary materials that are easy to obtain or other substitute waste. Some of these operations have very limited and possibly negative environmental benefits because they do not displace virgin material or they have negative side-effects, such as contamination of the natural environment, that exceed the benefits of reducing virgin extraction and processing.

Recovery operations can be evaluated by answering the following questions.

- Does the practice substitute primary resources or is it disposal in disguise?
- If the practice does substitute primary resources, are the associated benefits greater than the negative side-effects of applying the waste?
- Can the waste be recycled again after the first round of recycling, or will it be too dispersed and degraded?

**Box 7.4** explains the many recycling options for discarded tyres. Imagine you are hired to assess whether these options are environmentally beneficial. What methods and data would you use to answer the above three questions? A practice that does not meet the criteria for recycling should be considered disposal. At the end of the [next chapter](#), the fine line between recycling and disposal will be discussed again, but from the angle of disposal operations ([Section 8.6.2](#) on backfilling and land application).

### BOX 7.4 WHERE DOES A TIRED TYRE RETIRE?

Tyres get us many places, safely and comfortably; car, bike and air transport would make for a rough ride without rubber tyres. But where do tyres go when they are scrapped?

Waste tyres are hard to recycle because they consist of multiple materials besides rubber, and contain many potentially hazardous additives, including carcinogens. In the past, tyres were stockpiled or landfilled, consuming vast amounts of space and causing great environmental risk through leaching of chemicals and fire hazard. In 1990, the United States alone had about a billion tyres in stockpiles. Three decades later, the stockpiles had reduced to about 56 million tyres, but stockpiling or dumping remains common in countries with less-developed waste management infrastructure.

In high-income countries, tyres are used for a variety of purposes, but they are all energy recovery (see the [next chapter](#)) or open-loop recycling operations. [Figure 7.18](#) shows a breakdown of the use of tyres in the United States in 2019. Most commonly, tyres are burnt in cement kilns, pulp and paper mills or other industrial facilities. Some tyres are used in civil engineering applications, such as reinforcement of highway embankments. A small share of tyres is still disposed of in landfills.

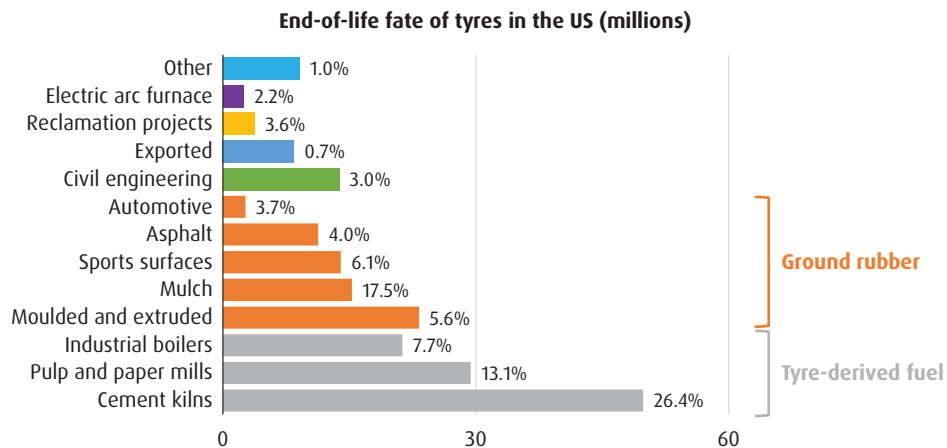

**Figure 7.18 Waste treatments for end-of-life tyres in the US in 2019.** Data taken from USTMA (2020).



Alternatively, tyres are ground to small pieces and the ground rubber (when separated from other material, such as steel wiring) is used for durable, tough surfaces, such as playgrounds and sports grounds, but potential leaching of contaminants remains a concern. The ground rubber can also be extruded or moulded into new (lower-quality) products, such as mats and speed bumps, or mixed with asphalt to improve road surfacing. In some cases, ground rubber is incorporated in new tyres, but the recycled rubber content for new tyres is practically zero.

Given their low recyclability, waste prevention is an attractive measure for addressing the problem of end-of-life tyres. Tyre re-treading can extend the life of tyres, and reduce tyre waste, by replacing the profile of the tyres (but not the full tyre). Re-treading also creates a waste stream but it can be more easily recovered than end-of-life tyre waste because it consists only of rubber.

## 7.7 SUMMARY

Recycling is often driven by cost savings, since secondary materials can be cheaper than virgin alternatives. Recycling may displace virgin material production, reduce the impacts of material processing and limit waste to landfill. Closed-loop recycling entails reprocessing of the waste in the same industry to make original product. Open-loop recycling entails reprocessing waste in the same industry, displacing the same type of virgin production, but producing a different product.

Recycling tends to reduce the cost of production, energy requirements for material processing and environmental impacts. However, recycling is not guaranteed to minimise environmental impacts and waste prevention is often more beneficial. Recycling metrics better represent the benefits of recycling when they focus on the displacement of virgin production (e.g., the recycled input rate) instead of the collection of waste (e.g., the collection rate).

Metal, plastics and paper are among the most widely recycled materials. The metal, plastic and paper waste are drawn from pre- and post-consumer sources and reprocessed into a feedstock consisting of liquid metal, plastic pellets or loose fibres, which can substitute virgin feedstocks made from natural resources. The secondary feedstock is generally of a lower quality than virgin feedstock and mixing with virgin inputs may be required to ensure sufficient quality. Other recyclables include textiles, glass, concrete, wood and rubber.

Recycling cannot completely displace virgin production due to processing losses, loss of quality and growth in consumption. Material that is kept in use

for longer cannot be readily recycled. Key challenges for recycling relate to contamination, which can be addressed through improvements in technologies and practices related to product design, product use, collection methods, waste sorting facilities and waste reprocessing.

Recycling is beneficial only if it displaces primary production and when the impacts of the recycling process are offset by the avoided impacts from virgin extraction. Some recycling operations skirt the line between recovery and disposal because the applications require very limited functionality, such as when materials are recycled as fillers. Moreover, many low-grade recycling operations preclude a second recycling loop because the materials have been downgraded and dispersed too much.

## **7.8 REVIEW**

- 1.** List the main types of material recovery and explain their differences.
- 2.** Give an example of open- and closed-loop recycling of clothing.
- 3.** Describe the main challenges and solutions for improving metal recycling.
- 4.** Suggest suitable metrics for measuring the performance of metals recycling.
- 5.** Describe the differences between virgin and secondary plastics production.
- 6.** Describe the different types of bioplastics and their (dis)advantages.
- 7.** Explain the role of fibre quality in the feasibility of paper recycling.
- 8.** Describe how you expect paper recycling to affect forests in your country.
- 9.** Give five examples of low-grade recycling options and explain their benefits.
- 10.** Explain the difference between low-grade recycling and regular recycling.



# 8

# ENERGY RECOVERY AND DISPOSAL

## LEARNING OBJECTIVES

After studying this chapter, you should be able to:

- understand the purpose of energy recovery and controlled disposal
- explain the operation and pollution control for MSW incineration
- describe the process and main aspects of anaerobic digestion
- explain landfill design, operation, closure and landfill mining
- describe the main characteristics of other final disposal methods



## 8.1 INTRODUCTION

The waste hierarchy suggests making the most of wastes by reusing or recycling them. When this is not possible, the next best option is the recovery of the energy stored in the bonds of organic molecules. Energy recovery has the additional benefit of replacing some of the energy otherwise provided through fossil fuels (though energy recovered from waste plastics is still of fossil origin). For inorganic materials, energy recovery is not possible; when they can be neither reused nor recycled, disposal to landfill is the only option.

This chapter focuses on energy recovery first, starting with the principles of using waste as a fuel, followed by the dominant energy recovery processes: the combustion of waste (specifically MSW), often called incineration, and anaerobic digestion. Together with gasification and pyrolysis ([Section 6.7](#)), these processes are referred to as ‘waste-to-energy’ (WtE) or ‘energy-from-waste’ (EfW). Wastes can also partially or fully replace fossil fuels in coal-fired power stations, or cement or steel production. This practice is known as coprocessing.

The last two sections of this chapter are dedicated to landfilling and other forms of land disposal. Landfilling is the least desirable practice in the waste hierarchy because it abandons material resources to uselessness and pollutes the environment. Nevertheless, it is still used for a significant proportion of wastes, including many with a potential for recovery, even in developed countries. The discussion of landfill will emphasise good practices that can decrease the negative environmental impacts of landfilling.

## 8.2 WASTE AS A FUEL

Waste properties differ vastly between economic sectors, which include households and the various industrial sectors. [Table 8.1](#) lists waste materials and streams and shows example values of key properties relevant to their use as fuels for

energy recovery. The ash content (second column) is the inorganic material in the waste that remains after complete combustion of the organic matter. On a dry-mass basis, the remaining percentage of the waste is the organic material that can be used for energy recovery.

Consider the combustion of cellulose, a natural polymer composed of glucose units, found in paper, wood and other plant tissues. Complete oxidation of organic matter yields  $\text{CO}_2$  and water as the main products. For cellulose, the standard combustion reaction at  $25^\circ\text{C}$  is shown in Equation 8.1, where  $n$  is the number of glucose units in the cellulose chain (Ur'yash et al. 2010).

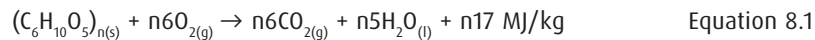

The reaction equation shows the release of 17 MJ of energy by the oxidation of 1 kg of cellulose. This energy – released by the combustion of organic matter as a fuel – is known as the *heating value*. There are three typical expressions of the heating value.

- The *higher heating value* (HHV) is equivalent to the heat of combustion at  $25^\circ\text{C}$  (e.g., 17 MJ/kg in the case of cellulose). Water formed by the oxidation of the fuel in a combustion reaction at high temperatures is initially in the gas phase. In the standard combustion reaction, this water vapour is condensed back to a liquid at room temperature. The energy released by the transition from the gas to the liquid phase, known as the heat of vaporisation, is included in the higher heating value.
- The *lower heating value* (LHV; fourth column of Table 8.1) does not include the heat of vaporisation. The lower heating value is of interest for energy recovery processes because after energy recovery takes place, the water is often emitted as a gas, rather than being condensed.
- The *gross heating value* (GHV) of a fuel is the LHV of the combustible organic matter in the fuel, minus the energy lost to evaporation of the moisture content. In the combustion process, energy supplied to heat the waste is initially consumed by evaporation of the moisture content before the dry organic matter can reach its ignition temperature. Some wastes, such as MSW, contain a significant amount of water (moisture content; third column of Table 8.1), which strongly reduces the GHV.

The properties of waste are typically reported on a dry-mass basis because the moisture content differs based on circumstances and can fluctuate with storage and processing conditions. Moisture is, however, important to many processes. In anaerobic digestion, moisture is needed by the micro-organisms that biodegrade the waste (Section 8.4.2).

**Table 8.1** Examples of waste fuel characteristics in comparison with coal and natural gas. Measurements for these materials can vary considerably from the values shown here.

Source: Leckner and Lind (2020); Wang and Nie (2001); Kijo-Kleczkowska et al. (2016); Hemidat et al. (2019); Greinert, Mrówczyńska and Szefner (2019); Garcés et al. (2016); Seyler et al. (2005); BEIS (2022).

Waste type	Ash content (% dry mass)	Moisture content (% wet mass)	Lower heating value (MJ/kg dry mass)
Cellulose	0	7	14
Food waste	5	64	3
Municipal solid waste	24*	55.4	4.7
Sewage sludge	36.4	4.9	12.5
Refuse-derived fuel from MSW by biodrying	18.2	25.5	15.2
Waste wood	0.4–2	<15	18.5–20
Plastics from end-of-life vehicles	6.1	0.4	34.3
Waste solvent coprocessed in cement manufacture	not reported	10.3	26.5
Hard coal	18.9	8.7	21.7
Natural gas (consumed)	0	0	35.5

\* Including glass and metal.

## EXERCISE 8.1 CALCULATING HEATING VALUES

Table 8.1 compares the lower heating value of a variety of waste fuels with those of fossil coal and natural gas. Based on its definition, and given that the heat of vaporisation of water is about 2.3 MJ/kg, can you estimate the GHV for these wastes using the other information in Table 8.1? How does MSW compare to plastics from end-of-life vehicles? Finally, what additional information would you need for the calculation of the HHV?

Figure 8.1 shows electrical energy generation from organic waste materials with different energy recovery technologies. Combustion directly yields heat, whereas anaerobic digestion and gasification yield fuels that are combusted to release heat. Engines of various types can convert heat to electricity. Compared with the lower heating values in Table 8.1, the electrical energy generated is much less than the energy content of the wastes because of the efficiency of each technology. All the materials shown in the figure can be combusted or gasified, except for conventional plastics and textiles, which are not suitable for anaerobic digestion. The gasification of food and yard waste is possible but not part of the study, nor is the potential use of residual heat (with combined heat and power; Section 8.3.4).

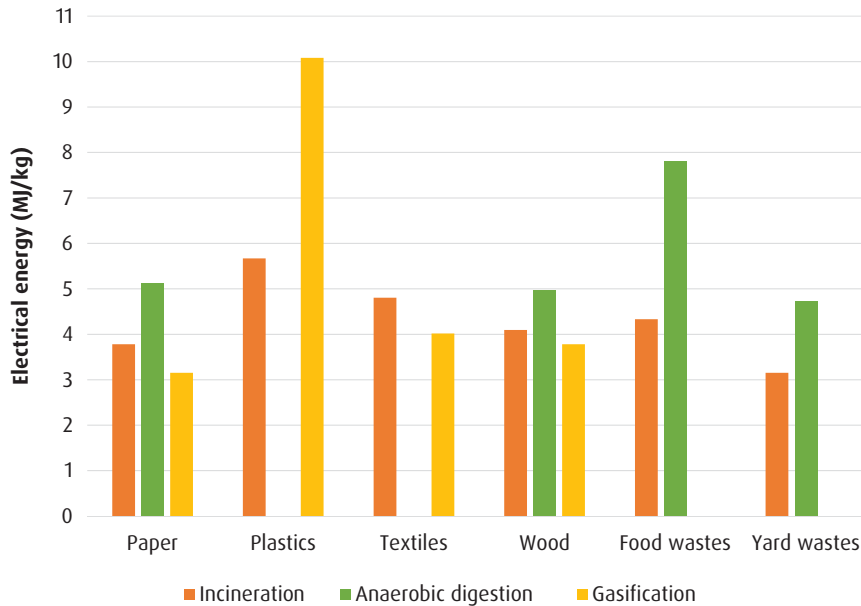

**Figure 8.1 Electrical energy recoverable from waste for different waste management options, adjusted for efficiency of electrical generation.** Adapted from Arafat, Jijakli and Ahsan (2015).

## 8.3 MUNICIPAL SOLID WASTE INCINERATION

### 8.3.1 Overview

Incineration was introduced in [Section 6.7.3](#) as a waste treatment technology that destroys organic wastes by thermal oxidation. One of the attractions of incineration for MSW management is that the destruction of the organic content can reduce the large waste volumes that we generate by 90 per cent. Modern incinerators also recover the energy that is released in this process.

[Figure 8.2](#) shows a schematic diagram of the most common type of MSW incinerator, a mass-burn incinerator. Facilities of this type have been designed around the world for MSW feed rates ranging from tens to thousands of tonnes per day. For example, the six furnaces of the Shenzhen East Waste-to-Energy Plant can burn up to 5,600 t/d, for electrical generation of up to 165 MW. In

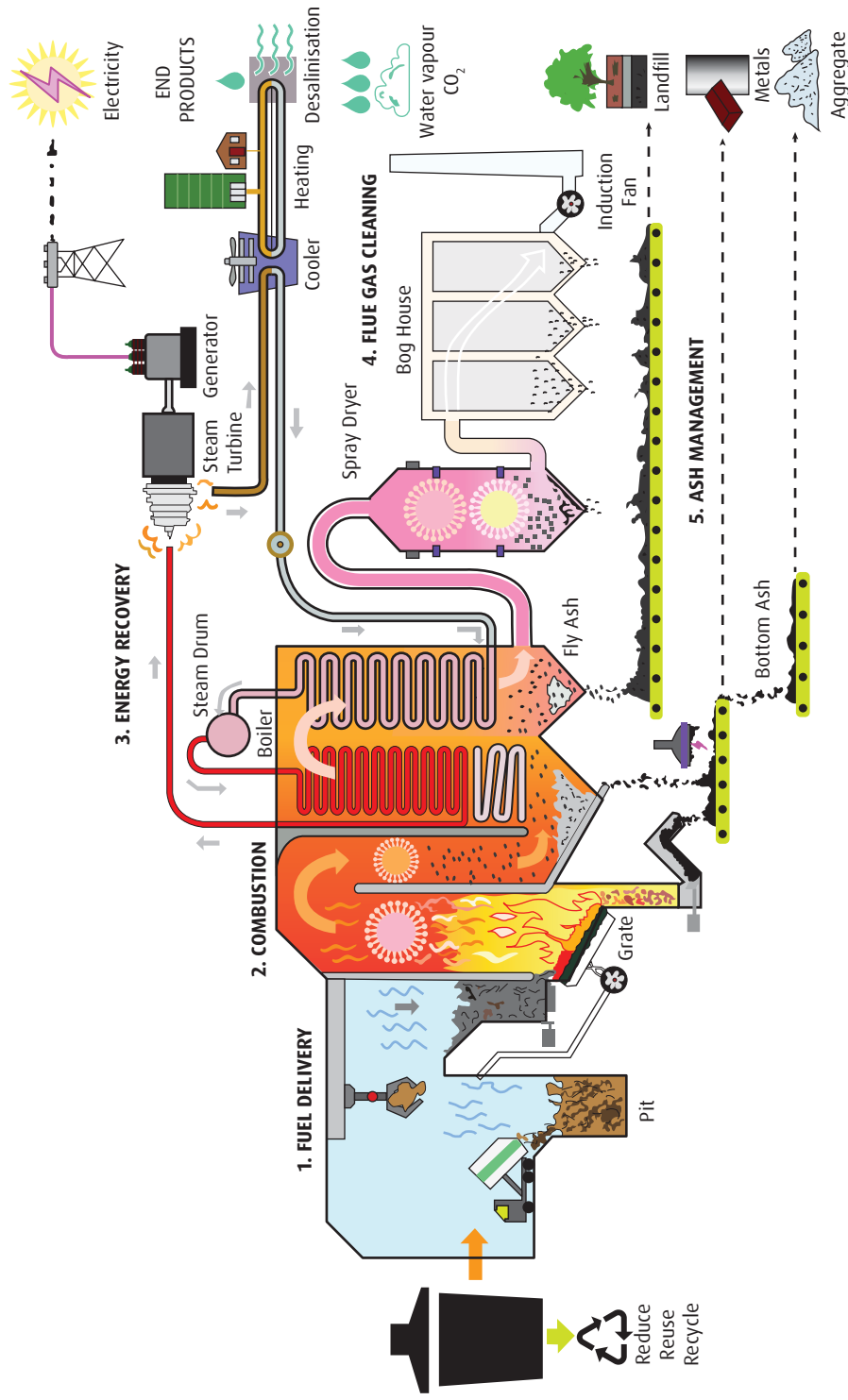

**Figure 8.2** Diagram of municipal solid waste combustion with energy recovery in a mass-burn incinerator. Redrawn from Deltaway (2018).

many ways, a mass-burn incinerator that uses MSW as a fuel resembles a power station that burns coal. However, the material handling systems for MSW differ from those for coal, which is a much more homogeneous material.

Mass-burn incineration runs as a continuous process, though regular shutdowns are necessary to maintain the furnace lining and boiler. The subsequent sections discuss five main parts of the overall process: fuel delivery, combustion, energy recovery, flue gas cleaning and ash management.

### 8.3.2 Fuel delivery

Residual MSW, remaining after separation of recyclables, is the most common fuel combusted in a mass-burn incinerator. Other wastes that contain organic materials may be co-combusted with MSW, provided they can be destroyed at MSW incineration temperatures. Since mass-burn incinerators are designed for MSW, the proportions of other wastes in the fuel are limited by the deviation of their characteristics from those of MSW. Wastes that are often co-combusted with MSW include nonhazardous commercial and industrial waste, waste wood, contaminants rejected from recycling facilities, RDF from MBT plants (Section 6.3.3) and agricultural waste (such as straw or animal litter).

Most residual MSW collected from households in garbage bags and/or shredded and crushed by a collection vehicle can be fed directly into the furnace. Collection vehicles arriving at the incinerator site have their documentation checked and are weighed and screened. Loads are rejected if, for example, they are not MSW or another agreed fuel, they contain hazardous materials or they include oversize materials such as mattresses or tyres. The permitted vehicles dump their loads into a waste pit or bunker. A remotely operated bulk-handling crane with an electric or hydraulic grab mixes the waste in the bunker and loads it into a feeding system that discharges onto the furnace grate of the incinerator, through a hopper or using hydraulic rams.

### 8.3.3 Combustion

The combustion of MSW takes place in a large fireproof chamber lined with refractory (heat-resistant) ceramic. The furnace grate supports the burning MSW and moves it through this incineration chamber. The grate is often sloped to help the MSW move through the incineration chamber by tumbling down. Commonly used 'reverse-acting' grates are composed of multiple reciprocating metal plates that push the waste back up the slope. The movements improve the access of oxygen to the MSW, and the freshly fed MSW is ignited by the burning MSW. The MSW is typically kept in the incineration chamber for several hours to ensure the solid organic matter gets fully burnt. Two variables are critical for the combustion process: air (oxygen) and temperature.

The air for the combustion process is drawn from the waste bunker, where it contains odour compounds such as volatile organic compounds and ammonia, which are subsequently destroyed in the incinerator to prevent contamination of the local air. The amount of air fed to the incineration chamber needs to be sufficient to completely oxidise the MSW fuel to CO<sub>2</sub> and water. Since the mixing of air with the fuel is imperfect and the fuel varies in its composition, 'excess air' is added to ensure complete combustion (Section 8.3.5). The amount of excess air in a modern incinerator is controlled based on the monitoring of the flue gas. It typically ranges from 20 to 50 per cent, depending on the fuel, incinerator design and operating conditions. Minimising the amount of excess air helps limit the oxidation of nitrogen to nitrogen oxides (NO<sub>x</sub>) (Section 8.3.5), and also reduces thermal losses and power consumption by fans.

The temperature of the flue gas above the bed of burning MSW on the grate is called the operating temperature. In modern waste incineration, the operating temperature is controlled to achieve high combustion efficiency. Usually, the required temperature is defined by legislation. For example, in the European Union, the Waste Incineration Directive requires the flue gas to be maintained at a temperature of at least 850°C for at least 2 seconds. A high temperature is necessary because fragments of organic compounds that are not completely oxidised to CO<sub>2</sub> and water (products of incomplete combustion; Section 2.3.3) may be toxic or could react to form toxic organic compounds. It is important that they are fully destroyed so that they are not emitted into the environment with the flue gas or flue gas cleaning products, or in the bottom ash (Sections 8.3.5 and 8.3.6).

After the organic matter in the MSW has been completely burnt, energy is recovered from the high-temperature flue gas before it is treated to remove pollutants and emitted into the atmosphere. The incombustible bottom ash falls off the end of the grate and enters the ash management system (Section 8.3.6).

### 8.3.4 Energy recovery

The hot flue gas containing the energy from MSW combustion is channelled into a boiler. In the boiler, the heat energy in the flue gas is transferred to water in a wall of tubes. The heat energy is transferred to the water in the boiler. The cooled flue gas is drawn through the air pollution control systems (Section 8.3.5) by an induced-draft fan and emitted from the stack. The boiler contains tubes that are part of a separate pressurised closed loop that includes a steam turbine. Heating the water in the tubes causes it first to evaporate, and then to heat up beyond boiling temperature, turning into high-pressure steam. The steam is used to drive the steam turbine, which rotates an electrical generator.

The efficiency of heat transfer from the flue gas to the water in the boiler tubes is about 80–90 per cent. However, electrical generation only recovers the energy used to pressurise the steam. The steam is not condensed back to liquid water, so electrical generation does not recover the energy used to evaporate it (the heat of vaporisation). This is one of the reasons that the gross efficiency of electrical generation is less than about 30 per cent. Considering the additional losses to power plant systems, the net efficiency of electrical generation by an MSW incinerator is only about 27 per cent.

The ‘low-grade’ low-pressure steam leaving the turbine can no longer do mechanical work. However, it still contains about half of the energy released by MSW combustion. Traditionally, the steam is cooled and condensed for return to the boiler, with the dissipation of this energy in a cooling tower. But this ‘waste heat’ can instead be recovered through a heat exchanger, in a ‘combined heat and power’ (CHP) system. In a CHP system, the heat from the low-grade steam is transferred to water in a separate closed loop that provides heat for other useful purposes off-site. Examples include community heating of homes or swimming pools, or industrial symbiosis ([Section 9.4.6](#)), such as heating of neighbouring industrial processes or greenhouses for agricultural production. Heat recovery clearly improves the overall efficiency of energy recovery; the overall efficiency depends on the balance between electricity and heat, and the characteristics of the waste heat recovery loop.

As is the case with many other industrial processes, not all MSW incineration facilities recover waste heat. One of the main reasons is that the infrastructure necessary to implement community heating is off-site from the incinerator. The potential difficulties include both the physical development of the infrastructure and the negotiation of contracts between the incinerator company and the prospective users of the energy.

### EXERCISE 8.2 HOW ENERGY GETS LOST

The heat of vaporisation of water features both here and in [Section 8.2](#) as a cause of reduced energy recovery, in the context of water present in the fuel fed to the incinerator, the evaporation and condensation of water formed by combustion, and water that captures the heat from MSW combustion in the boiler. In each case, can you explain the mechanisms by which energy is lost?



### 8.3.5 Flue gas cleaning

Flue gas from municipal waste incineration mainly contains unreacted nitrogen and excess oxygen, together with the main reaction products from thermal oxidation of MSW: CO<sub>2</sub> and water. The share of other components in the flue gas is relatively small but they can have significant environmental impacts when dispersed into the environment. Table 8.2 shows the typical composition of incinerator flue gas before treatment. There are many technologies for emissions control and new ones are continuously being invented. The European Best Available Techniques (BAT) Reference Document for Waste Incineration refers to no fewer than 408 technology combinations.

**Table 8.2 Composition of untreated flue gas from municipal waste incineration.** Adapted from Neuwahl et al. (2019).

Component	Concentration (mg/m <sup>3</sup> of gas at 0°C and 101.3 kPa unless otherwise indicated)
O <sub>2</sub> reference value	11%
Carbon dioxide (CO <sub>2</sub> )	5–10%
Water steam (H <sub>2</sub> O)	10–20%
Carbon monoxide (CO)	5–50
Total organic carbon (TOC)	1–10
Polychlorinated dibenzo-p-dioxins (PCDDs) and polychlorinated dibenzofurans (PCDFs) (as 2,3,7,8-tetrachlorodibenzo-p-dioxin)	0.5–10 ng/m <sup>3</sup>
Inorganic chlorine compounds (as HCl)	500–2,000
Inorganic fluorine compounds (as HF)	5–20
Sulphur oxides (SO <sub>2</sub> and SO <sub>3</sub> ) (as SO <sub>2</sub> )	200–1,000
Nitrogen oxides (NO <sub>2</sub> , NO, N <sub>2</sub> O, NO <sub>3</sub> , N <sub>2</sub> O <sub>5</sub> )	150–500
Nitrous oxide (N <sub>2</sub> O)	<40
Mercury (Hg)	0.05–0.5
Cadmium and thallium (Cd and Tl)	<3
Lead (Pb), antimony (Sb), arsenic (As), chromium (Cr), cobalt (Co), copper (Cu), manganese (Mn), nickel (Ni), vanadium (V) and tin (Sn) (Pb, Sb, As, Cr, Co, Cu, Mn, Ni, V, Sn)	<50
Fine particles (fly ash)	1,000–5,000

The next few paragraphs describe the flue gas components shown in [Table 8.2](#) and the relevant common air pollution control technologies.

Carbon monoxide (CO) and total organic carbon (TOC) refer to incompletely oxidised carbon and organic matter. They are monitored in the flue gas to determine whether the oxygen (air) supply is sufficient ([Section 8.3.3](#)). Operation of the incinerator can be adjusted to keep these pollutants below regulatory limits, which are based on their health impacts.

Polychlorinated dibenzo-p-dioxins (PCDDs or 'dioxins') and polychlorinated dibenzofurans (PCDFs or 'furans') are toxic and carcinogenic, even in small quantities. Dioxins result from the reaction of incompletely oxidised organic molecules with chlorine, in the presence of metal catalysts, such as copper, in a temperature range of 400–700°C. Such conditions were common in older incinerators with poor control of combustion ([Box 8.1](#)). In modern incinerators, the combustion temperatures and residence times ([Section 8.3.3](#)) are designed to avoid the formation of dioxins and furans in the boiler and air pollution control systems. Since no practical process can be 100-per-cent efficient, very small quantities of dioxins and furans are still formed and emitted.

Acid gases, which can contribute to acid rain, are present in several forms. Hydrochloric and hydrofluoric acid arise from chlorine and fluorine, which in turn derive from polyvinyl chloride (PVC) and polytetrafluoroethylene (PTFE) plastics that are still present in many consumer products and discarded in MSW. Sulphur dioxide and sulphur trioxide emerge in the furnace through the oxidation of sulphur in the organic compounds in the MSW. Acid gases can be removed using a scrubber ([Table 6.4](#)). Commonly used semi-dry scrubbers spray hydrated lime ( $\text{Ca}(\text{OH})_2$ ) slurry into the flue gas stream to cool it and react with the acid gases to form solid salts, including  $\text{Ca}(\text{SO}_4) \cdot \text{H}_2\text{O}$  and  $\text{CaCl}_2$ .

$\text{NO}_x$  is another source of acid rain, an air pollutant implicated in the formation of ozone and a contributor to global warming. Air is 21 per cent oxygen and 78 per cent nitrogen; most of this nitrogen in the incinerator combustion air passes through without reaction. However, a small proportion of it, as well as nitrogen in the MSW, is oxidised to nitrogen oxides, known together as  $\text{NO}_x$ . The formation of  $\text{NO}_x$  is primarily controlled by minimising excess air and avoiding excessively high combustion temperatures.  $\text{NO}_x$  that does form can be reduced to  $\text{N}_2$  by injecting ammonia as a reducing agent, either with a catalyst (selective catalytic reduction (SCR)) or without (selective non-catalytic reduction (SNCR)).

Some metals, especially mercury, remain in the gas phase. Activated carbon may be injected into the flue gas (after a wet scrubber) for the removal of mercury and trace organic pollutants, such as dioxins, by adsorption ([Tables 6.4](#) and [6.5](#)).

Fly ash consists of fine particles with an average size of 50–100  $\mu\text{m}$ . These particles, mostly containing aluminosilicates and partly melted, are entrained in the flue gas as it rises above the burning MSW. Metals with a low boiling temperature are volatilised from the MSW during combustion and partly condense on these particles. Antimony, arsenic, bismuth, cadmium, copper, indium, molybdenum, phosphorus, selenium, silver, tin and zinc have all been found to be more concentrated in fly ash than in the earth's crust. Many of these elements, as well as small amounts of organic products of incomplete combustion associated with fly ash, are toxic.

Fly ash is removed together with the waste products from the other treatments: the solid salts and excess reagent from the scrubbing of the acid gases, and activated carbon. Modern incinerators frequently use fabric filters in a baghouse for particulate removal (Table 6.4). A baghouse contains thousands of tubular bag filters made of heat-resistant fabric. The flue gas is drawn through the filter by a vacuum to capture the solid air pollution control residues. The cleaned gases are emitted from the stack. The residues are periodically shaken from the bags by a pulse of compressed air and collected for management.

### BOX 8.1 WHO LIVES NEXT TO AN INCINERATOR?

Despite more stringent regulation of emissions from incinerators and resultant technological improvements in modern incineration practice, incinerators remain unpopular neighbours. The siting of waste management facilities is well-known to be affected by 'NIMBYism', whereby locals loudly protest: 'not in my backyard!' (NIMBY).

Incinerators suffer in particular from a negative reputation due to past polluting behaviour, as well as the generation of hazardous air pollution control residue. However, most MSW management facilities also make poor neighbours because of odours, debris and pests associated with MSW, the noise and visual impacts of the facilities, and the movement of large vehicles on local roads.

A study of 107 incinerators in France found that 'after controlling for a town's socio-economic characteristics ... each additional 1% of a town's population that is foreign-born increased the odds that the town received an incinerator by 29%. Disproportionate siting near concentrations of immigrants thus generates environmental injustice in France' (Laurian and Funderburg 2014). Similarly, 'waste incinerators are three times more likely to be built in the UK's most deprived neighbourhoods than in the least', where 'people of colour are overrepresented' (Roy 2020). This trend is continuing for proposed and planned incinerators, of



which 'nearly half are on track to be built in the UK's top 25% most deprived neighbourhoods' (Roy 2020).

The authors suggest that 'wealthier neighbourhoods are often perceived as more worthy of preservation and protection, ... rubbish is left to be dealt with in the most deprived communities' (Roy 2020). On the other hand, waste management facilities may provide local benefits, such as employment, district heating and tax revenues, which are most attractive to poorer communities. The colocation of community amenities such as recreation centres with incinerators can make a difference; a comparison of 13 incinerators in Seoul, the Republic of Korea found 'substantial negative impacts on local land and real estate markets' only for the incinerators that lacked colocated amenities (Han, Laurian and Go 2020).



**Figure 8.3** The Spittelau incinerator in Vienna, completed in 1992, was designed by Friedensreich Hundertwasser to be an attractive local landmark, rather than an ugly industrial site. Image: Shutterstock.

### 8.3.6 Ash management

After combustion, the original volume of the MSW fuel is reduced by 90 per cent, and about 25 per cent of the mass remains as ash. Fly ash only represents about 10 per cent of the ash. The other 90 per cent arises as incinerator bottom ash (often called IBA), which is dumped from the grate after combustion. It also usually includes a small proportion of coarse particles that drop out of the gas in the boiler (boiler ash), before the air pollution control system. In some regions, the two types of ash are collected and managed together as ‘combined ash’. However, separate collection enables better management based on the distinct properties of the ash.

Bottom ash is a granular material comprised of about 10–12 per cent metals and 80–85 per cent minerals. The metals arise from household items, such as electrical goods, packaging, cutlery, tools and so on. Typically, bottom ash leaving the furnace is dumped into a quench tank with water to cool it. Together with the boiler ash, it is transferred by truck to a stockpiling area, which is open to the atmosphere. During an ageing period of two to three months, the newly formed bottom ash minerals react with the atmosphere, the quench water and rain. The weathering results in a more chemically and volumetrically stable mineral fraction for utilisation. The pH is reduced and magnesium oxide (MgO) and metals are hydrated. An impermeable pad captures leachate from contact with rainwater for subsequent treatment.

The bottom ash may be processed for metal removal before or after the ageing period, depending on the facility. Some facilities no longer quench bottom ash to recover the metals more efficiently from the dry ash. A system of conveyors and screens (Table 6.1) separates the ash into particle-size fractions. Ferrous metals are separated from the minerals using magnets. Nonferrous metals are removed using eddy current separators. The nonferrous metals account for 20–50 per cent of the metal stream and are an important source of revenue because of their high value. Increasingly, bottom ash processing facilities feature sophisticated crushing and ballistic techniques to recover valuable metals that are present in small fragments or trapped in sintered bottom ash minerals.

**Table 8.3 Example compositions of incinerator bottom ash (after stockpiling and removal of ferrous and nonferrous metals) and air pollution control residue from municipal waste incineration.** Adapted from Bogush et al. (2015) and Gupta et al. (2021).

Component	Indian incinerator bottom ashes		UK air pollution control residues	
	Mean	CoV (%)	Mean	CoV (%)
Loss on ignition at 1,000°C	6.9	16	2**	not determined
pH	8.3-10.5	not estimated	12	2
Bulk elements (% dry mass)				
Aluminium (Al)	2.6	7	1.5*	35
Calcium (Ca)	9.1	9	26	12
Chlorine (Cl)	0.8	30	17*	26
Iron (Fe)	1.9	7	0.9	57
Potassium (K)	0.7	10	2.8	30
Magnesium (Mg)	1.8	6	0.6	16
Sodium (Na)	0.3	28	2.2	25
Phosphorus (P)	0.2	32	0.5	33
Sulphur (S)	0.7	9	0.5*	21
Silicon (Si)	25	4	0.3*	27
Toxic trace elements (mg/kg dry mass)				
Arsenic (As)	6	6	25	30
Cadmium (Cd)	4	22	130	51
Chromium (Cr)	300	55	83	18
Copper (Cu)	380	18	460	16
Mercury (Hg)	0.09	22	10**	not determined
Nickel (Ni)	68	25	39	31
Lead (Pb)	140	28	1,600	31
Antimony (Sb)	10	28	380	29
Tin (Sn)	21	20	390	36
Zinc (Zn)	980	17	5,900	31

CoV (%) = Coefficient of variation =  $100 \times \text{standard deviation}/\text{mean}$

\*Actual concentrations may have been underestimated by the chemical analysis method used

\*\*Approximate figures

Table 8.3 (second and third columns) provides a detailed overview of the typical composition of bottom ash, after stockpiling (weathering) and removal of metals, from an Indian study. The table distinguishes the following categories.

- The 'loss on ignition' is about 7 per cent, which is the fraction of the ash that can still be volatilised at high temperatures. About two-thirds of this number is organic matter that has escaped combustion, usually because of lower-temperature areas on the grate. The rest consists of inorganic carbonate minerals.

- The corrosive pH (typically >12) has been decreased to below 10 by the reaction of lime ( $\text{Ca}(\text{OH})_2$ ) in the bottom ash with  $\text{CO}_2$  in the air.
- The bulk elements comprise the mineral fraction of the bottom ash. They feature high concentrations of silicon and calcium and are typically recovered as aggregates for construction.
- The trace elements are present in small concentrations only, but are still a concern because of their toxicity (the units are in mg/kg, equivalent to parts per million, whereas the unit for the bulk elements is the percentage). The concentration of the trace elements exceeds those in natural construction minerals, which can be a barrier to recovery.

Bottom ash is generally used as loose aggregate in applications distant from water bodies that could be sensitive to pollution, because of the high concentration of soluble salts (notably compounds containing potassium, sodium, chloride or sulphate). Moreover, it is only used in certain applications. For instance, the use of bottom ash as concrete aggregate should be avoided because the soluble salts could corrode the steel reinforcement.

The fly ash, collected together with the other air pollution control residues, is much harder to recover. Taken together, the air pollution control residues represent 2–6 per cent of the original mass of the MSW fuel. Their management is challenging because of their properties (which can lead to situations such as those described in [Box 4.4](#)); [Table 8.3](#) (fourth and fifth columns) shows an example composition for air pollution control residues from a recent UK study. First, air pollution control residues have a corrosive pH (greater than 12) due to excess reagent from the scrubber system. Second, they contain high concentrations of soluble salts and toxic metals, and may contain toxic organic pollutants (e.g., dioxins and furans).

Fly ash is regulated as hazardous waste in most jurisdictions and disposed of in landfill. Stabilisation/solidification of air pollution control residues with cement ([Section 6.5.4](#)) is sometimes attempted, but its effectiveness is thwarted by its high solubility. Whether mixed with cement or not, landfilling of air pollution control residues is problematic because soluble salts and toxic metals will dissolve and eventually migrate into the environment. For both air pollution control residues and bottom ash, it can be better to recover the salts and metals as an industrial raw material or inert mineral residue for a range of construction uses. The choice of method should be based on cost-benefit analysis that incorporates the environmental outcomes ([Section 3.4.4](#)).

## 8.4 ANAEROBIC DIGESTION

### 8.4.1 The production of biogas and fertiliser

Anaerobic digestion was introduced in Section 6.6.4 as a waste treatment technology based on incomplete biological oxidation of readily biodegradable organic matter by micro-organisms. Just like incineration, it decreases the mass and volume of waste. However, rather than generating heat directly, it produces biogas, which contains a high proportion of methane ( $\text{CH}_4$ ), just like natural gas. Biogas can be combusted onsite for the generation of electricity (and/or heat) or concentrated to a higher  $\text{CH}_4$  content for injection into the natural-gas grid. Anaerobic digestion also produces a nutrient-rich slurry that can be used as a fertiliser. The largest anaerobic digesters process more than 1,000 t/d, in multiple digestion vessels, and feature electrical capacities of over 15 MW. But even small-scale anaerobic digesters with feed rates of less than 1 t/d can be viable (Box 8.2).

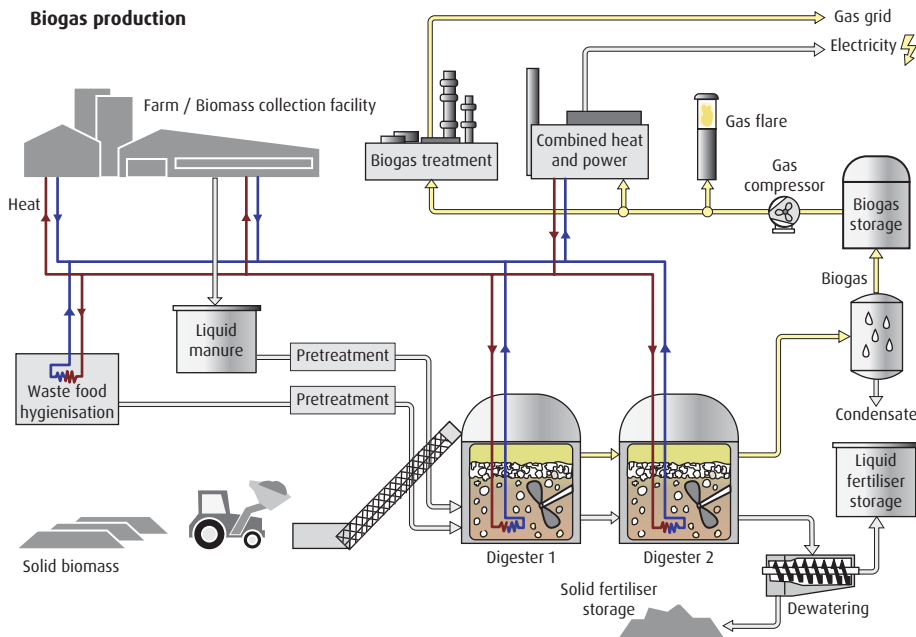

**Figure 8.4 Biogas and fertiliser production using anaerobic digestion.** Redrawn from Sigma Energy.

Figure 8.4 shows a schematic diagram of the main steps in a continuously operating wet anaerobic digestion facility. The next few sections discuss four main parts of the process: feedstock preparation, digestion, biogas generation and use, and digestate processing and use.



## BOX 8.2 LIVING LABORATORIES FOR MICRO-ANAEROBIC DIGESTION

Micro-anaerobic digesters, with a capacity of 5–1,000 kg/d, have the potential to provide an efficient local source of biogas from local food waste.

The Calthorpe Community Garden in London, UK provides a valuable green space of 0.5 ha where local residents can garden, learn new skills, play sports and relax. It is a haven for wildlife and has a mission to educate a diverse community about nature and sustainability. The garden's facilities include a micro-digester that produces biogas from food waste generated by local homes and businesses, including the on-site community café. The biogas is supplied to the café for cooking and for heating indoor growing spaces and the digestate is used to fertilise the allotment gardens.

Another micro-digester can be found at the nearby Camley Street Natural Park. These sites fulfil a valuable function as a 'living lab' for experimental facilities. For the company behind the micro-digesters, the living labs provide an opportunity to prototype their technology and learn about the challenges and opportunities for circular food management in the built environment. After experimenting with small-scale digesters, the company scaled up an anaerobic digestion system for a social housing estate in East London, where it aims to increase food waste recycling and create green jobs.



**Figure 8.5** The Camley Street Natural Park micro-anaerobic digester (left), for food waste collected with a cargo bike from hotels, canteens and offices within a one-mile radius. Volunteers (right) learning food-growing skills at Calthorpe Community Garden in London, UK. Image: Rokiah Yaman, Leap Micro AD, madleap.co.uk.

## 8.4.2 Feedstock preparation

Anaerobic digestion has been used for over a century to make biogas and fertiliser from manure and sewage. Since these wastes arise from the aerobic digestion of food by animals and humans, their energy contents are depleted in comparison with that of the food itself. Anaerobic digestion by microbes can recover much of the energy that remains. Suitable feedstocks include household food waste; agricultural wastes such as leaves and stalks of crops; park and garden waste; food industry wastes such as husks and peelings, meat-processing wastes, dairy wastes and brewery wastes; algae; paper; and many others. Anaerobic digestion is also used to convert non-waste energy crops, such as maize or grasses, to fuel and chemical feedstocks, but this chapter focuses on waste.

Different types of biomass decompose at different rates, as evidenced by our own digestive systems and refrigerators. A peeled orange, containing about 70 per cent dry mass of easily digestible sugars, rots quickly in the refrigerator. But orange peel, with about 70 per cent cellulose, 9 per cent hemicellulose and 20 per cent indigestible lignin, remains recognisable for a while even in a compost bin. Woody plants, with around 40 per cent cellulose, 30 per cent hemicellulose and 30 per cent lignin, may not fully decompose for years.

The potential of a biomass feedstock to decompose and produce methane in an anaerobic digestion process can be estimated based on its composition or measured in laboratory testing. [Table 8.4](#) compares relevant characteristics for different types of biomass which affect the facility design and operation.

At mass ratios of carbon to nitrogen (C:N) above about 30, the microbes will have insufficient nitrogen to build the protein that they need for their metabolism. At C:N ratios below 20, high concentrations of toxic ammonia ( $\text{NH}_3$ ) will poison the micro-organisms performing the digestion. Relatively dry biomass with a water content of 60–75 per cent, such as crop and yard wastes, appears as a solid. Biomass with higher water content, such as manure or sewage sludge, is a pumpable slurry. A more liquid slurry requires less energy for pumping but also yields a more liquid digestate, which may require further treatment ([Section 8.4.5](#)).

**Table 8.4 Characteristics of different waste feedstocks for anaerobic digestion.**

Adapted from Xu, Wang and Li (2014) and Xu et al. (2022).

Feedstock	Volatile solids <sup>a</sup>	Extractives <sup>b</sup>	Lignin	Cellulose	Hemicellulose <sup>c</sup>	C:N ratio	Moisture content	CH <sub>4</sub> yield <sup>d</sup>
	% dry mass						% wet mass	L/kg VS
Food waste	93	30	NM	7	1.6	12	78	530
Paper packaging	93	8	13	52	13	223	5	250
Corn stover	82-96	6.5-10	15-19	34-41	15-23	15-39	73-82	80-157
Wheat straw	83-95	13-17	15-17	32-38	15-22	19-36	78-82	66-130
Leaves	87-93	35-43	23	11-12	4.2-12	18-22	78-82	47-75
Yard trimmings	92-97	15-180	22-26	22-27	9-14	20-32	78-82	32-50
Tree trimmings	>99	9.6-17	27-33	23-31	12-16	18	86	11-16
Switchgrass (energy crop)	90	12	18	32	17	43	82	125

<sup>a</sup> Volatile solids (VS), determined by heating a sample to high temperature (usually 550°C), are a measure of the organic content of a waste

<sup>b</sup> Extractives are water- and ethanol-soluble materials, including free sugars, organic acids and other small organic molecules

<sup>c</sup> Hemicellulose was determined as xylan for all but food and paper waste

<sup>d</sup> Methane yield after 30 days (40 days for food and paper waste) with feedstock inoculation by effluent (feedstock-to-effluent ratio = 2:3)

NM = Not measured

### EXERCISE 8.3 FEEDSTOCK PROPERTIES

Looking at the data in [Table 8.4](#), which characteristics of the feedstock seem to most influence the methane yield? Why is that the case?

The biomass fed to a digester must be homogeneous and consistent over time because the micro-organisms that carry out the digestion are adapted to its characteristics. An anaerobic digester can be designed to digest specific types of biomass by controlling the conditions that affect the speed of decomposition. Co-digestion of several types of biomass may support a more stable and efficient population of micro-organisms that yields more biogas. Pretreatments can improve digestion and increase biogas yields, including:

- the removal of contaminants, such as packaging plastics in food waste, to affect biomass processing or digestate quality
- chopping, shredding and grinding to increase the surface area for contact with micro-organisms and to damage cells to release nutrients

- ultrasonic or high-pressure mixing to damage cells and create a more homogeneous feedstock
- heat treatment, usually below 100°C, to break down cell walls and kill pathogens (just as cooking food helps with human digestion)
- the addition of small quantities of trace elements, such as cobalt (Co), selenium (Se), nickel (Ni) and molybdenum (Mo), to provide essential micronutrients for microbial metabolism
- chemical treatment with reagents such as ozone (O<sub>3</sub>), sodium or potassium hydroxide (NaOH or KOH), Fenton's reagent (hydrogen peroxide, H<sub>2</sub>O<sub>2</sub>, and ferrous chloride, FeCl<sub>2</sub>), or hydrochloric or sulphuric acid (HCl or H<sub>2</sub>SO<sub>4</sub>) to damage the biomass cells by chemical oxidation

Caution needs to be exercised with chemical pretreatments because they can also lead to reactions that make the biomass more difficult to degrade. Nevertheless, chemical pretreatment is important for some types of biomass, such as wood.

Finally, before digestion, the feedstock is often pre-inoculated with partly digested biomass from the digester or digestate, in which micro-organisms adapted to the process are thriving. Inoculation with specialised micro-organisms is less common, as they may not be able to outcompete those that are already present.

### 8.4.3 Digestion

Following potential pretreatment, anaerobic digestion of the feedstock takes place in one or more digester vessels. The design of the vessel depends on the type of biomass.

- Dry solid biomass is typically digested in a plug flow process, in which feedstock charged to the digester passes through with little mixing with the material ahead or behind. The biomass is usually fed by conveyors to the top of a vertical cylindrical digester and moves through the digester by gravity.
- Wet materials are digested in a stirred-tank reactor, in which materials are continuously mixed ([Section 6.3.4](#) describes the use of stirred-tank reactors for metal-finishing wastewaters). The vessels are made of concrete or steel and are lined with glass or epoxy resin to prevent their corrosion by the acidic contents.

An anaerobic digestion facility may run several digesters in series, with digestion progressing from vessel to vessel. Digesters may also be arranged in parallel to increase facility capacity.

The digestion system must be well sealed to exclude oxygen and avoid aerobic biological oxidation of the biomass to CO<sub>2</sub> and water rather than biogas. It is

also essential to prevent methane leakage, first, because methane mixed with air can be explosive (Box 6.4) and, second, because of the global warming potential of methane. The facility must operate under a negative pressure to prevent the leakage of odorous compounds into the surrounding neighbourhood.

Temperature and residence time are the main process control variables for anaerobic digestion (just like for thermal oxidation). In nature, anaerobic degradation of biomass is carried out by a wide variety of micro-organisms over a wide temperature range, at different rates. However, the degradation rate is temperature-dependent, with fewer organisms thriving at higher temperatures.

- Mesophilic anaerobic digesters often operate at ambient temperatures between 20 and 45°C. The micro-organisms that predominate in this temperature range are known as mesophiles. To speed up anaerobic digestion, insulated mesophilic digesters are warmed to around 35°C, for example, using waste heat from a CHP plant that burns the biogas (Sections 8.3.4 and 8.4.4).
- Thermophilic anaerobic digesters may operate at higher temperatures, up to 70°C. In this range, reaction times are faster. Because higher temperatures also kill pathogens present in the biomass, thermophilic digestion may be required by law for some types of biomass. For example, in the EU, animal byproducts require a minimum digestion temperature of 57°C for 5 h or 70°C for 1 h.

The use of mesophilic temperatures tends to be preferred if pathogens are not of concern because it requires less heat and supports a more stable microbial population.

Regardless of the temperature, the anaerobic digestion process comprises of four stages.

- In hydrolysis, bacteria decompose large molecules, such as carbohydrates, proteins and fats, into soluble smaller molecules, such as sugars and amino acids.
- In acidogenesis, these molecules are converted by acidogenic bacteria, mainly into organic acids, CO<sub>2</sub> and ammonia.
- In acetogenesis, the organic acids are further converted into acetic acid.
- In methanogenesis, the acetic acid is converted to methane and CO<sub>2</sub>.

Figure 8.4 shows an anaerobic digestion facility with two digesters in series. Digestion is possible in a single digester, but the two-stage process enables adjustment of the conditions in each of the digesters to suit a different population of micro-organisms. Hydrolysis, acidogenesis and acetogenesis mainly take

place under the conditions provided in the first digester. The partly digested biomass, or acidogenic digestate, is then pumped to the second digester, where conditions favour methanogenesis. Since different types of organic molecules are decomposed at different rates by different organisms, all four stages of anaerobic digestion overlap to some extent and biogas is collected from the top of both digesters.

The time allowed for digestion depends on the type of biomass and the operating conditions. Most digesters have a residence time between one and six weeks. The residence time must permit decomposition of all readily degradable organic matter to avoid the uncontrolled further decomposition of materials discharged from the digester and to achieve the maximum biogas yield.

Biogas and digestate recovery are discussed in the following two sections. [Box 8.3](#) presents a more advanced form of anaerobic digestion that can produce useful organic chemicals.

### BOX 8.3 ENERGY AND RAW MATERIALS FROM ANAEROBIC DEGRADATION

A biorefinery is a potential alternative to fossil-fuel-based refineries. In a biorefinery, biomass, such as energy crops, algae, agricultural or forestry wastes or even MSW, is used as a feedstock for the biological production of raw materials and products such as biofuel, industrial biochemicals and biomaterials including bioplastics. A variety of technologies for biorefining are under development. One example is based on the second stage of anaerobic digestion: acidogenesis.

Acidogenesis produces mainly organic acids,  $\text{CO}_2$  and ammonia, and can also produce hydrogen ( $\text{H}_2$ ). Hydrogen is a desirable product, as it has a higher energy content per unit of mass than other fuels and does not contain carbon, but the amount in biogas is typically less than 1 per cent. Acidogenesis has the advantage of producing a range of useful biodegradation products. These could be the raw materials for other valuable products.

The efficiency and products of acidogenesis can be significantly influenced by selecting and pretreating mixed microbes with diverse metabolic functions. It is critical to prevent the progression of the digestion process to methanogenesis (used to produce biogas), where  $\text{H}_2$  would be consumed by the formation of methane.

The use of acidogenesis to produce hydrogen and bio-based raw materials and products in a biorefinery must be cost-competitive with chemical or electrolytic hydrogen production and with fossil-fuel refining to be commercially viable. Nonmonetary costs to the environment and society ([Section 3.4.4](#)) could be considered in this balance.

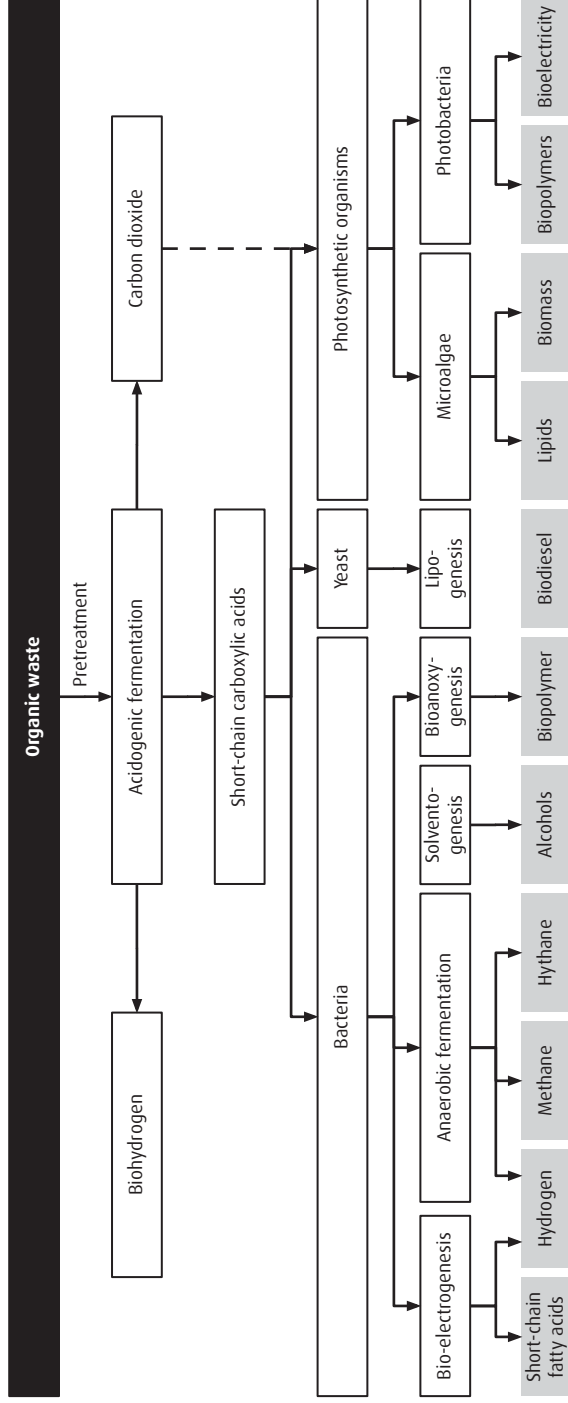

**Figure 8.6 A biorefinery concept for production of bio-based raw materials and products.** Adapted from Venkata Mohan et al. (2019).

### 8.4.4 Biogas generation and use

Biogas typically contains about 60 per cent methane and 40 per cent CO<sub>2</sub> (Section 6.6.4). The composition depends on the biomass being digested and the operating conditions. Table 8.5 shows the range of composition for biogas. The largest fraction is for methane, the main energy carrier in biogas. It is present because of the deliberate exclusion of oxygen from the process, which prevents the full biological oxidation of organic matter to CO<sub>2</sub>. A substantial proportion of fully oxidised carbon, CO<sub>2</sub>, is nevertheless present, because of the oxygen present in carbohydrates and other organic materials, as well as the presence of some air in the biomass feed.

**Table 8.5 Composition of untreated biogas from anaerobic digestion of agricultural, food, municipal and industrial wastes (compilation of data from approximately 20 plants).**

Adapted from Calbry-Muzyka et al. (2022).

Component		Percentage (%), dry volume basis
Methane	CH <sub>4</sub>	25-69
Carbon dioxide	CO <sub>2</sub>	18-44
Nitrogen	N <sub>2</sub>	0.1-19
Oxygen	O <sub>2</sub>	0.1-3
		Parts per million by volume
Ammonia	NH <sub>3</sub>	0.1-70
Hydrogen sulphide (as S)	H <sub>2</sub> S	2-6,470
Carbon monoxide	CO	100-200
Hydrogen	H <sub>2</sub>	<100
		mg/m <sup>3</sup>
Siloxanes (as Si)		<0.02-3.4

Table 8.5 shows that small quantities of ammonia and hydrogen sulphide are also produced by anaerobic digestion. Both gases are toxic and can poison the microbes in the digester.

- Ammonia arises mainly from the incomplete oxidation of proteins, which are found in all biomass. Its formation can be avoided by controlling the C:N mass ratio of the biomass feedstock (Section 8.4.2).
- Hydrogen sulphide arises from the incomplete oxidation of the sulphur in many organic molecules. Controlling the C:S ratio is difficult, but the formation of H<sub>2</sub>S can be avoided through the addition of iron salts. The formation of H<sub>2</sub>S is also sensitive to process variables, such as pH, which explains the considerable variation in H<sub>2</sub>S reported in Table 8.5.



The other trace components of biogas shown in [Table 8.5](#) are carbon monoxide, hydrogen, siloxane and volatile organic compounds. Carbon monoxide and hydrogen are potential fuels, but their concentrations are very small. Siloxanes are manmade chemicals used to make silicone rubber and additives for shampoo. They are found in both household waste and wastewater.

Biogas that contains mainly methane and  $\text{CO}_2$ , without significant quantities of other impurities, can be used directly for cooking, heating and lighting. It can also be combusted in an on-site gas engine to provide electricity to the food processing plant that produces the waste being digested. The relevant technologies are similar to those presented in [Section 8.3.4](#).

- In a gas engine, high-pressure gases from biogas combustion convert heat to motion (like water vapour in a steam turbine), which then drives an electrical generator. In a reciprocating engine, combustion gases drive pistons; in a gas turbine, they drive turbine blades.
- In a combined-cycle power plant, the exhaust from a gas turbine is used to generate steam for conversion of heat to motion in a steam turbine, with both driving an electrical generator. A combined cycle is more efficient at generating electricity than a single engine.

Alternatively, biogas can be upgraded and injected into the natural-gas grid or compressed for vehicles that run on liquified natural gas (LNG). Commercial natural gas contains 85–90 per cent methane, with 10–15 per cent ethane and nitrogen. Biogas must be upgraded to reduce the concentrations of  $\text{CO}_2$  and other impurities, such as hydrogen sulphide and siloxanes. When hydrogen sulphide is combusted as part of biogas, it oxidises to sulphur dioxide ( $\text{SO}_2$ ). It must therefore be removed to avoid air pollution that contributes to acid rain ([Table 2.1](#)). Combustion of siloxanes in biogas produces silicon dioxide ( $\text{SiO}_2$ ), a mineral that causes deposits on burners and the wear of engine parts.

Common upgrading processes for biogas include pressure swing adsorption, amine scrubbing or membrane separation ([Table 6.4](#)). In pressure swing adsorption,  $\text{CO}_2$  and other impurities are removed by adsorption onto a solid ([Table 6.5](#)) under pressure. Amine scrubbing removes these impurities by absorbing them into a solution of alkylamines in water. With membrane separation ([Table 6.4](#)), the methane is separated from the impurities by molecular filtration through a membrane with appropriately sized pores, under pressure or vacuum. The upgraded gas is known as biomethane but has the same chemical formula as methane from fossil sources.

### 8.4.5 Digestate processing and use

Depending on the type of biomass and process operating conditions, 5–80 per cent of the feedstock for anaerobic digestion is composed of complex organic molecules that cannot be decomposed within the digester residence time. These materials, together with dead microbial cells, the inorganic components that cannot be biologically decomposed and the water associated with the feedstock, comprise the digestate.

Table 8.6 shows composition ranges for dried samples of digestate. About three-quarters of the dried solids are undigested organic matter, which is often measured as total carbon. The remaining solids are inorganic materials, including the essential macronutrients nitrogen (the majority in solution as the ammonium ion), potassium, phosphorus, calcium, magnesium and sulphur, and micronutrients such as boron, chlorine, manganese, iron, zinc, copper, molybdenum and nickel. For contaminated feedstocks, such as from MBT or residual waste, the high concentrations of trace elements may present risks to human and environmental health. Siloxanes, which cause practical issues when combusted in biogas, are also problematic as pollutants in digestate because they are persistent and bioaccumulate.

**Table 8.6 Composition of anaerobic digestate, and its liquid and solid fractions.** Adapted from Möller and Müller (2012) and Peng and Pivato (2019).

Component	Digestate	Digestate solids	Digestate liquor
Organic matter (% dry mass)	69–75	-	-
Total carbon* (% dry mass)	36–45	40	48
Carbon-to-nitrogen ratio	3–9	11–19	4–5
NH <sub>4</sub> <sup>+</sup> (% of total N)	44–81	26–49	40–80
Phosphorus (P) (% dry mass)	0.6–1.7	1.9	0.4–0.7
Potassium (K) (% dry mass)	1.9–4.3	3.6	3.9
pH	7.3–9	8.5	7.9
Water content (% wet mass)	87–99	75–81	93–95
<b>Trace elements (mg/kg)**</b>			
Cadmium (Cd)	<0.4	-	-
Chromium (Cr)	6–40	-	-
Copper (Cu)	14–80	-	-
Lead (Pb)	9.8–36	-	-
Mercury (Hg)	<0.23	-	-
Nickel (Ni)	11–20	-	-
Zinc (Zn)	56–300	-	-

- Not reported

\* In organic matter

\*\* In digestate from food waste

The organic matter in digestate is similar to the compost from the aerobic degradation of biomass (Section 6.6.3). It is valuable as a soil conditioner that retains moisture and supports soil micro-organisms that gradually decompose it (soil micro-organisms support the uptake of nutrients by plants and are essential to soil health). The nutrients in digestate can also support the growth of plants. Therefore, digestate is often applied to agricultural land or in forestry as a fertiliser. The utilisation of this byproduct of biogas production by anaerobic digestion avoids the need for chemical fertilisers that are produced and transported using fossil fuels.

If more digestate is applied to land than plants can immediately use, it runs off to pollute ground and surface waters, because the nutrients in digestate are either dissolved or relatively soluble. Excessive nutrients in natural waters cause eutrophication (Table 2.1), which often manifests as an algal bloom. When the algae die, their decomposition depletes dissolved oxygen in the water needed by other aquatic life, destabilising the ecosystem. To prevent this, regulations usually limit the amount of digestate that can be applied and restrict the timing of digestate application to the growing season. Regulations and guidelines may also prevent land application of digestate that contains unsafe levels of pollutants.

Disposal of excess digestate (that cannot be applied to land) can also lead to nutrient pollution. Fortunately, other recovery options are available when the digestate is dewatered first, often using a decanter centrifuge or screw-press separator, resulting in a solid and liquid fraction.

- The solid fraction is enriched in phosphorus and therefore has different fertiliser applications than the digestate as a whole. It may be composted for greater biological stability, dried using waste heat or pyrolysed to create biochar (Table 6.7) before it is applied to land. If there are contaminants present, it may be landfilled or combusted.
- The liquid fraction, the digestate liquor, may be used as a high-nitrogen and -potassium fertiliser with better handling characteristics than the digestate itself. It may be used to grow algae, fixing both CO<sub>2</sub> and nutrients, and yielding additional biomass that can be fed back to the digester. Struvite (NH<sub>4</sub>MgPO<sub>4</sub>·6H<sub>2</sub>O) in the liquor can be recovered by precipitation and used as a solid fertiliser because of its phosphorus content. The digestate liquor can also be treated for discharge by membrane purification, ammonia stripping or in an activated sludge process (Table 6.6).

Alternatively, the digestate may not be dewatered but treated for disposal in a wetland or reed bed. Compared to untreated disposal, this leads to fewer issues with nutrient runoff, and the slow accumulation and degradation of solid organic matter.

## 8.5 LANDFILL OF MUNICIPAL SOLID WASTE

### 8.5.1 Disposal of waste by landfilling

Dumping unwanted materials and items into a convenient hole in the ground is a time-honoured way of getting rid of waste. In the past, landfills were typically created by filling the holes in the land left by quarrying or aggregate extraction. Many landfills still in use today are located in old quarries or sandpits, particularly if they originated before the middle of the twentieth century or are in regions with less-developed infrastructure.

Most wastes dissolve or decompose over time, leading to the formation of leachate containing nutrients and other pollutants. This leachate pollutes groundwater if the disposed waste can be infiltrated by rainwater and is placed in or on porous rock or sediment, especially below the water table. Since sandpits are often located near water bodies, surface water pollution may also result.

The observation of pollutants leaching into water, and other environmental impacts from the enormous quantities of waste that have been landfilled in the past century, have led to greater regulation of landfilling. Some wastes, such as liquids and explosives, are now usually banned from landfill. It is also common to require treatment of waste before landfilling.

The concept of a sanitary landfill emerged out of environmental concerns. In a sanitary landfill, waste is isolated from the environment. [Table 8.7](#) contrasts the features of a modern engineered landfill (see also [Figure 8.7](#)) with those of uncontrolled dumps.

**Table 8.7 Typical features of engineered landfills as compared with uncontrolled dumps.**

Dump	Engineered landfill
Site chosen for convenience, often near human habitation and water	Low-risk site away from natural surface and groundwaters
No consideration of geotechnical stability; danger of collapse or liquefaction	Slopes and dams designed to be geotechnically stable, including design elements and safety factors for storms or earthquakes
Miscellaneous, often porous, host geology, e.g., quarry or sand pit	Composite liner system composed of one or more layers of geomembrane or geosynthetic clay liner over compacted clay
Mixed, untreated MSW and industrial wastes	No liquid wastes; treated residual waste only; separation of different waste types, especially nonhazardous wastes from hazardous wastes
Emission of leachate into groundwater, which often flows through the landfill	Leachate collection system composed of geotextile, geogrid, gravel and perforated pipe, followed by leachate treatment
Emission of gases from waste decomposition into the atmosphere; percolation of rainwater through the mass of waste	Gas collection wells; a composite cover system composed of a porous gas collection layer, geomembrane, compacted clay and drainage layer to prevent the entry of water and emission of gases
No risk assessment or monitoring	Risk assessment; environmental monitoring plan

Most modern landfills are very large to enable efficient operation and to minimise the number of sites needed. For example, one of the largest landfills in the world, the Sudokwon Landfill in Incheon, Republic of Korea serves a population of more than 22 million people and covers an area of more than 1,700 ha. It has a depth of up to 40 metres and contains nearly 150 Mt of waste, accumulated over just 27 years of operation (SL Corp 2021; Chung and Kim 2009).

The Sudokwon Landfill contains a mixture of wastes: 17 per cent household waste, 34 per cent construction waste and 49 per cent industrial waste, including waste from water treatment, wastewater treatment and incineration. Such wastes are typical of those landfilled in urban areas. The next sections explain landfill siting, design and operation, leachate and gas management, and closure. The focus is on the landfilling of MSW; the landfilling of other waste is discussed separately in [Section 8.6.1](#) (though many of the principles are the same).

### 8.5.2 Landfill siting

Ideally, landfills are located close to waste generators to reduce transport, but also as far as possible from people to avoid negative impacts on the local population. As a result, decisions about the siting of landfills are among the most publicly contentious, akin to the siting issues prevalent for incinerators ([Box 8.1](#)). For fairness, siting decisions should be based on a transparent stakeholder consultation process, in which local residents voice concerns about sustainability, increases in road traffic, emissions of odour and dust, the attraction of scavenger animals and health risks. Such discussions generally lead to the siting of landfills out in the countryside, rather than near the cities where the waste is generated.

In the absence of fair and transparent decision-making, landfills tend to end up close to disadvantaged communities because land prices are low and residents do not have the political clout to shape the decision-making in their interest. Landfill siting issues gave birth to the environmental justice movement and remain highly relevant to it ([Box 8.4](#)).

Geotechnical considerations also play a role in the siting of landfills. A hydrogeological risk assessment is usually carried out to assess the risks to environmental and human health based on what is known about the site geology and the waste itself. First, to avoid water pollution from runoff, landfills are not best sited near surface water bodies such as rivers, lakes or the ocean. Second, to avoid groundwater contamination with leachates, landfills may be situated above the water table (the upper surface of the groundwater aquifer). Although the term 'landfill' implies the filling of a hole, engineered landfills may be above grade in areas where the water table is high.

It is preferable to site a landfill in an area with a deep natural layer of clay soil. If the landfill is excavated below grade, clay is cohesive and provides stable side slopes that will not collapse or slip when the waste is placed against them. Composed of tiny flat particles smaller than 0.002 mm in diameter, clay is relatively impermeable to water. When the clay has a hydraulic conductivity (rate of water transmission) of less than  $1 \times 10^{-9}$  m/s, dissolved pollutants will migrate through it more quickly by diffusion (movement caused by molecular motion) than they can be carried in water flowing through it. Siting a landfill in a thick bed of clay thus provides an inherent barrier to groundwater pollution by leachate.

#### BOX 8.4 LANDFILL SITING: THE BIRTH OF ENVIRONMENTAL JUSTICE

A series of articles in *The Guardian* explored environmental (in)justice, which it defined as ‘how ecological hazards and climate disasters have the harshest impacts on people of color, native tribes and those on low incomes’. One of the interviewees was Dr Robert Bullard, known as the ‘father of environmental justice’, whose career started with a lawsuit on landfill siting.

*I started working on environment and race in 1978/79 by collecting landfill data for a landmark civil rights lawsuit filed by my wife in Houston, Texas, against the city and the state. This study found that between the 1930s and 1978, 82% of all the waste in Houston was dumped in black neighborhoods, even though only 25% of the population was black. This was not random or isolated; it was targeted and widespread across the southern states and the nation. We lost in court but the concept of environmental racism was born.*

*The seminal Environmental Justice principles adopted by the National People of Color Environmental Leadership Summit in 1991 built on this [legal case] and became the foundation for social justice movements across the world. Even so, the same discrimination and racism continues to dictate who gets dumped on and who gets resources to mitigate floods, wildfires and other disasters. Of course those with wealth and political clout do best; if you have money you can buy bottled water or move house. The poor cannot go anywhere.*

Siting of waste facilities and environmental justice are still intimately connected. If you search the news from your country or region, you can probably find recent examples.

Source: Lakhani (2019).

### 8.5.3 Design and operation

Figure 8.7 shows a schematic diagram of the features of a modern engineered landfill, including the liner system, leachate collection and treatment system, and gas collection and recovery system.

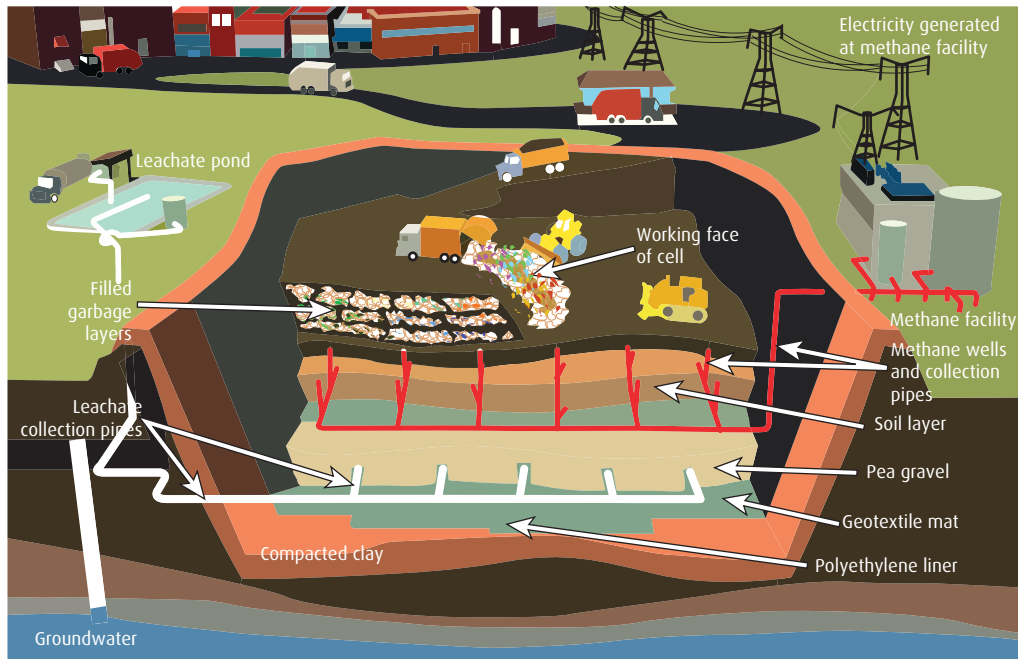

**Figure 8.7 Features of a modern landfill.** Adapted from Wasatch.

When clay is not naturally present at the site, an engineered landfill may feature a liner system, consisting of the following components:

- The main component of the liner system is a 2-metre-thick layer of clay. Careful construction of the clay liner in compacted lifts (layers) is necessary to achieve the desired hydraulic conductivity.
- A plastic liner (geomembrane) (Figure 8.8) may act as a second barrier to capture leachate, composed of flexible high-density polyethylene (HDPE), low-density polyethylene (LDPE), polyvinyl chloride (PVC) or polypropylene (PP), with a thickness of several millimetres. The geomembrane comes in sheets of up to 10 m × 30 m, which are rolled out smoothly against the prepared clay bottom surface of the landfill, with heat or solvent welding of adjoining sheets.



- Alternatively, or in addition, landfills may feature a geosynthetic clay liner (GCL), with dry bentonite sandwiched between layers of felt. When the bentonite becomes wet, it swells to create a layer with low permeability and natural resilience to punctures.

The composite clay and plastic liner system should prevent leachate from escaping through holes in the geomembrane liner and reaching the underlying groundwater. However, since the clay will react with the landfill leachate over time, it can become more permeable or develop deep cracks and even small holes, eventually leading to groundwater contamination. Monitoring wells in the groundwater aquifer upstream as well as downstream of the landfill site helps detect groundwater quality issues. However, it is rarely feasible to excavate the landfill to repair leaks, leaving long-term groundwater treatment as the only potential remedial action.



**Figure 8.8 A plastic liner (geomembrane) to capture landfill leachate.** Image: MPCA Photos.

---



The landfill leachate collection system lies immediately above the geomembrane. It consists of perforated pipes embedded in a layer of gravel. The geomembrane is prevented from being torn or punctured by the gravel thanks to a protective layer of felt, though some damage should be expected in the long run. The gravel is covered by another layer of geosynthetic felt and soil to prevent clogging by solids that settle out from the waste. Leachates percolate through the landfill by gravity until hindered by the liner system. They are collected in the gravel layer and pumped out of the landfill through the perforated pipe system for subsequent treatment (Section 8.5.4).

Landfills are usually very large, but they are constructed and filled in much smaller cells. These cells are typically filled in daily lifts. The waste arrives on site in trucks that dump it near the edge of the cell. It is moved around and compacted using earth-moving equipment. Good compaction is important both for efficient use of space and for geotechnical stability, to enable safe movement of equipment on the upper landfill surface. Filling with MSW generates odours, dust and wind-blown materials, and attracts scavengers. These problems can be partly prevented by covering each lift at the end of the day with a layer of relatively inert material, such as CLO from MBT (Section 6.3.3).

#### 8.5.4 Leachate collection and treatment

Landfills are sealed by their liner and cover systems, but some leakage should be expected through percolation of rainwater or groundwater, which becomes leachate by dissolving potential pollutants. Hazardous industrial wastes may leach toxic metals and a range of toxic organic pollutants, or may create a corrosive alkaline or acidic leachate. Hazardous wastes in MSW, such as paint, cleaning agents and garden chemicals, can also leach such pollutants. However, the main component of leachate from MSW tends to be dissolved organic matter and other nutrients from organic waste.

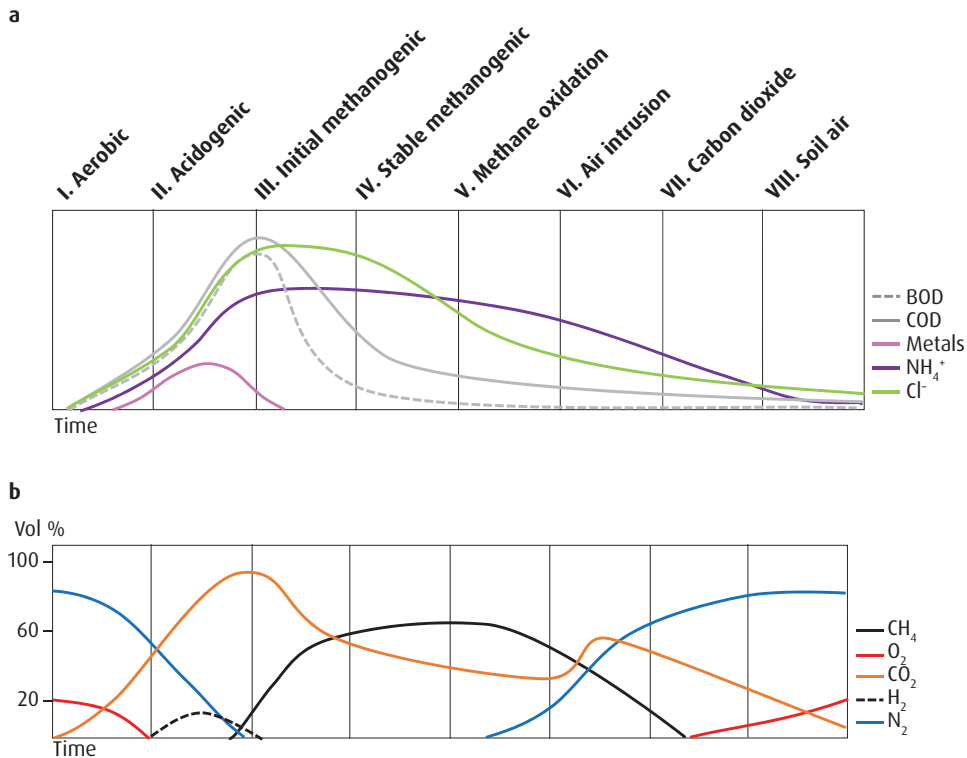

**Figure 8.9 Landfill leachate (a) and gas (b) composition predictions as a function of time.**

Adapted from Kjeldsen et al. (2002).

Figure 8.9a shows the predicted evolution of the composition of MSW landfill leachate over the long term (Figure 8.9b shows this for landfill gas, explained in the next section). The timescale is qualitative; each of the eight stages of decomposition can take at least several decades. The predictions for the first three stages are backed up by monitoring data, but less data is available to validate the trends in the later stages. The graph shows the following:

- The biological oxygen demand (BOD, dashed grey line) indicates the oxygen needed for micro-organisms to oxidise the dissolved organic matter. It is a measure of the amount of biodegradable organic matter present, based on the amount of oxygen needed to decompose it.
- The chemical oxygen demand (COD, grey line) indicates the amount of oxygen that would be needed to chemically oxidise the organic matter. It is higher than the BOD since some of the organic matter cannot be biologically degraded.
- The metals (pink line), ammonium ions ( $\text{NH}_4^+$ , purple line) and chloride ( $\text{Cl}^-$ , green line) indicate the presence of dissolved substances in the leachate.

Initially, the decomposition of waste in the landfill is mainly aerobic because oxygen is available before the landfill is covered, and also in the porosity of the waste (Stage I in Figure 8.9a). Solid organic matter in the landfill is hydrolysed by micro-organisms and then oxidised to CO<sub>2</sub> and water. Once the landfill is covered to prevent entry and exit of water, air is also excluded (Stage II in Figure 8.9a), and decomposition is mostly anaerobic, resulting in the same processes as for anaerobic digestion (Section 8.4.3). The formation of organic acids reduces the pH of landfill leachate so that other pollutants, particularly metals, become more soluble. Ammonia from the decomposition of proteins is dissolved as the ammonium ions.

In Stages II, III and IV in Figure 8.9a, soluble salts, most often containing chloride, are dissolved and continue to be released over the landfill lifespan, gradually becoming depleted. At the same time, the amount of organic matter starts to decline. Depending on the proportion of biodegradable material in the waste, the decline causes substantial changes in waste volume (and the potential geotechnical instability of the landfill). The decrease in volume can be sufficient to enable the extension of the landfill's life, with new waste taking up the volume released by waste decomposition. In the later stages of the landfill's lifespan (Stages V to VIII in Figure 8.9a), more air enters the landfill, enabling aerobic decomposition to take place.

**Table 8.8 Composition of landfill leachate, in comparison with municipal wastewater, seawater and drinking water.** Adapted from Kjeldsen et al. (2002); Jiménez, Alzaga and Bayona (2002); Henze and Comeau (2008); WHO (2017).

<i>(a) Major components</i>			
Parameter (mg/L)	Landfill leachate	Municipal wastewater	Seawater
BOD	20–57,000	230–560	2
NH <sub>4</sub> <sup>+</sup>	50–2,200	20–75	0.02–0.4
P	0.1–23	6–25	0.1
Cl <sup>-</sup> + SO <sub>4</sub> <sup>2-</sup>	150–12,000	200–600	20,000
Na + K	20–11,000	81–1,200	11,000
Ca + Mg	10–22,000	32–380	1,700
Fe + Mn	3–6,900	3–40	0.004
pH (units)	4.5–9	7–8	8.1
Conductivity (S/m)	0.25–3	0.007–0.012	3–6
<i>(b) Pollutants</i>			
Pollutants (mg/L)	Landfill leachate	Municipal wastewater	WHO Drinking Water Standards
As	0.01–1	-	<0.01
Cd	0.0001–0.4	0.001–0.004	<0.003
Cr	0.02–1.5	0.01–0.04	<0.05
Cu	0.005–10	0.03–0.1	<2



**Table 8.8 (Cont.)**

<i>(b) Pollutants</i>			
Pb	0.001–5	0.03–0.08	<0.01
Hg	0.00005–0.16	0.001–0.003	<0.006
Ni	0.02–13	0.01–0.04	<0.07
Zn	0.03–1,000	0.1–0.3	aesthetic (<4)
Benzene, toluene, ethylbenzene and xylene (BTEX)	0.005–220	-	<0.01–0.7
Chlorinated hydrocarbons	0.26–510	0.01–0.05*	variable (<<1)

- Not reported

\*Dichloromethane

**Table 8.8** compares the compositions of MSW landfill leachate with municipal wastewater (sewage), seawater and drinking water. The concentrations of BOD, ammonia and a variety of pollutants in landfill leachate considerably exceed those of municipal wastewater. Some landfill leachates are as salty as seawater, and their pH can be quite acidic. Landfill leachate is often collected in a nearby lagoon for the aerobic conversion of ammonia to nitrate. Other physical, chemical or biological treatment may be needed to adjust the pH and remove organic matter (BOD) or other pollutants before the effluent can be discharged to natural waters.

Some landfills are managed as bioreactors. They aim for rapid degradation of organic matter to reduce the volume of landfilled waste and create space for landfilling more waste. They also produce a high yield of landfill gas for energy recovery (see the [next section](#)). In that case, the leachate collected at the bottom of the landfill is recirculated to the top of the landfill to stimulate biodegradation. This practice also results in further degradation of dissolved organic matter in the leachate.

### 8.5.5 Gas collection and recovery

The decomposition of the organic matter in landfilled waste also produces gaseous products. **Figure 8.9b** shows the predicted long-term generation of gases, categorised by the same eight stages of decomposition as discussed for landfill leachate (see the [previous section](#)).

- *Stage I.* Aerobic decomposition consumes oxygen and nitrogen from the air.
- *Stage II.* As anaerobic decomposition starts, CO<sub>2</sub> continues to be produced, along with a small amount of hydrogen, during acetogenesis.
- *Stage III.* During the anaerobic decomposition of hydrolysed organic matter, methane is the main gas produced, along with CO<sub>2</sub>.
- *Stage IV.* When air begins to enter the landfill due to breaches in the cover system, the production of methane gradually ceases.

For much of the landfill lifecycle, the gas produced by the degradation of organic matter has essentially the same composition as biogas from waste treatment by anaerobic digestion (Table 8.5 and Figure 8.4). The presence of landfill gas contributes to the risk of landfill fires (Figure 8.10). Moreover, landfill gas entering the atmosphere is a major cause of climate change, accounting for 11 per cent of global methane emissions and 1.8 per cent of global greenhouse gas emissions in 2010 (GMI 2011; WRI 2022).

Ideally, emissions of landfill gas are avoided by separately collecting organic wastes for controlled anaerobic digestion. If the waste is landfilled anyway, a large proportion of the resulting landfill gas can still be captured and used for energy recovery. Figure 8.7 shows a network of wells to collect gas from deep within the landfill. The gas is collected under vacuum, with a recovery rate of about 60–85 per cent. Landfill gas can be recovered the same way as biogas from anaerobic digestion (Section 8.4.4); it may be combusted locally after minimal treatment or purified for compression or injection into the natural-gas grid.



**Figure 8.10** A fire at the Milton landfill site near Cambridge, UK. Fire and rescue services in the UK attend around 300 significant fires in waste sites each year.

Image: Cambridgeshire Fire and Rescue Service.

---



**Figure 8.10 (Cont.)**

### **BOX 8.5 MODELLING LANDFILL GAS GENERATION IN MEXICO**

In areas with less-developed infrastructure, landfilling is the primary mode of formal waste management, and usually takes place alongside uncontrolled informal waste management (Box 2.3). While other waste management alternatives must be developed, there is also an urgent need to capture and use landfill gas. This box summarises a study that was conducted to evaluate the spatial and temporal distribution of landfills in Mexico, and the associated landfill gas generation and potential for electrical generation over the next 80 years.

The researchers used geographic information systems to examine the spatial distribution of landfills in Mexico. They created a landfill gas generation model to estimate emissions from 1,782 landfills and assessed the suitability of each site for the collection of landfill gas to generate electricity. According to the estimates, Mexico generated 2,300 Mm<sup>3</sup> of landfill gas in 2020, of which less than 1 per cent was used, generating 165 GWh of electricity. By contrast, up to 2,500 GWh/y of



electricity could have been provided by landfill gas and would have avoided the emission of 1.45 Mt of CO<sub>2</sub> from the combustion of fossil fuels.

Unfortunately, only 4.6 per cent of Mexican landfill sites were found to be suitable for landfill gas collection. Even if this capacity was fully used, the emission of the remaining 95 per cent of landfill gas into the atmosphere would represent a major source of greenhouse gas emissions. While existing landfills will continue to emit landfill gas for some time, the researchers believed that the avoidance of more landfilling has the potential to prevent 1,600 Mt CO<sub>2</sub>eq of landfill gas emissions.

Source: Rueda-Avellaneda et al. (2021).

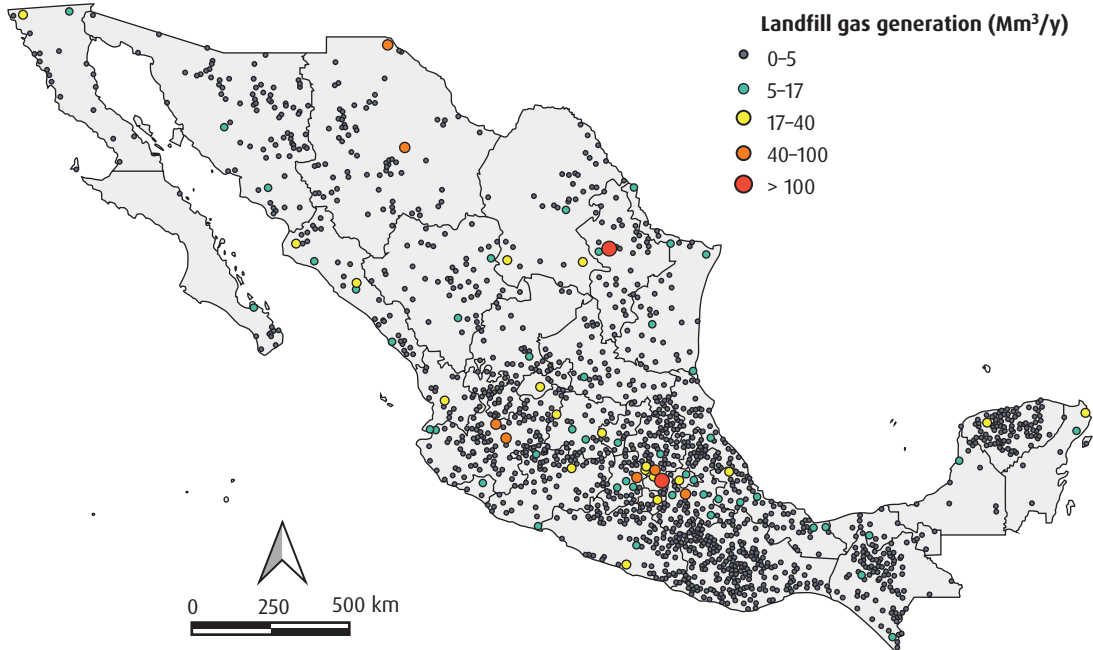

**Figure 8.11 Spatial distribution of landfill gas emissions in Mexico.** Image: Rueda-Avellaneda et al. (2021).

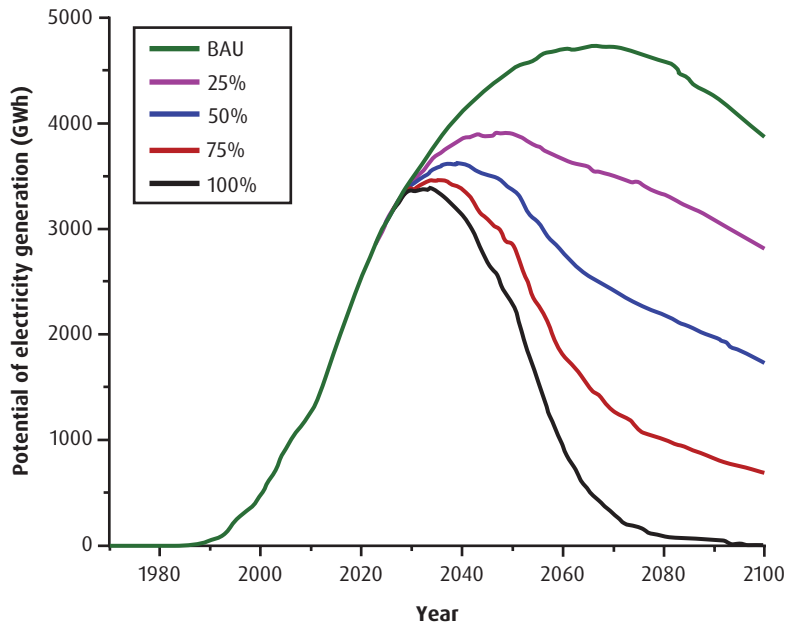

**Figure 8.12 Potential for generation of electricity from landfill gas over time in Mexico, for a scenario based on current trends in MSW disposal (business-as-usual, BAU), compared with scenarios for 25, 50, 75 and 100 per cent reduction of MSW landfilling.**

Image: Rueda-Avellaneda et al. (2021).

### 8.5.6 Landfill closure and mining

Once a landfill has been filled to its capacity, the generation of leachate and the leakage of gas into the atmosphere can be reduced by installing a cover (or capping) system. The layers of the cover system resemble those of the bottom liner system, but in reverse order. The cover features, from bottom to top:

- a porous gas collection layer, which may be a synthetic mesh or also gravel
- a layer of protective felt, a geomembrane and a layer of compacted clay
- a growing medium, usually covered only with grass, because larger plants could damage the cover with their roots and would fail to thrive when the roots reach the acidic waste

Closed landfills often become well-groomed recreational areas, such as golf courses or playing fields, and the sloped sides can be a convenient site for solar panels.



In a circular economy (Chapter 9), landfills can be considered stores of valuable materials for future landfill mining (Boxes 3.11 and 8.6). Mining of an MSW landfill involves the excavation of the waste using a backhoe, and sorting with processes similar to those in an MBT (Section 6.3.3). Since there is significant cross-contamination of materials ‘stored’ in landfills, they are much less valuable than source-separated materials (Section 6.2.3).

Similar to geological mining, landfill mining poses dangers for workers. Landfills can be physically unstable and a source of exposure to toxins and pathogens in the leachate and gas. This is especially true for landfills established before they became strictly regulated. They may be poorly compacted or geotechnically unstable due to decomposition of the organic waste. Under such conditions, digging equipment can be swallowed by the decomposing MSW, with fatal consequences for the operator. Older landfills may also contain hazardous waste, with no record of the amount or composition.

### BOX 8.6 GETTING RICH FROM LANDFILL MINING OF BITCOIN

Some materials, such as metals, have always been sufficiently valuable to be commonly recovered. Consequently, such materials are rare in landfills, which negatively affects the economic case for landfill mining. An additional driver for landfill mining is therefore usually needed, for example, the recovery of space for urban development (Box 3.11) or the necessity of environmental remediation.

In an unusual case in Wales, a computer engineer named James Howells had an altogether different reason for trying to mine a landfill. He wanted to recover a hard disk with a digital wallet that he had mistakenly discarded in 2013. The digital wallet contained 7,500 Bitcoins he had mined on his computer in 2009. The Bitcoins had an initial value of less than \$10, but by 2013 they were worth \$7,500,000.

When Howells realised his mistake, he wanted to get his hard disk back – out of the Newport Docksway landfill site. At that point, the hard disk was likely to be buried under four feet of MSW, somewhere in an area the size of a football field. Finding the hard disk would require Howells to hire two men and two diggers, who needed to work for potentially a very long time and under dangerous conditions. To Howells, that seemed too much effort, but by November 2021 the value of the discarded Bitcoins had reached more than \$450,000,000. There was also more



waste accumulated on top of the hard disk, which would make the operation costlier, but the economic case for landfill mining was stronger than ever.

Still, the local council opposed the project for all the reasons that bedevil landfill mining: the physical, chemical and biological hazards associated with the waste, leachate and landfill gas. They worried about worker safety during the excavation and the consequences for the local environment and community. Even if Howells received a landfill permit, one more factor could hinder his mining plans: by the time he might have found the hard disk, the value of the Bitcoins may have dropped below the total cost of excavation.

Source: Hern (2013); Middleton (2022)



**Figure 8.13 Mining of landfilled waste is associated with physical, chemical and biological hazards.** Image: Shutterstock.

## 8.6 OTHER TYPES OF DISPOSAL AND RECOVERY

### 8.6.1 Land disposal of other waste

While MSW landfills are a common sight, other types of waste may also be disposed of on land. Many countries have landfills for specific types of waste. For example, in the EU, there are separate types of landfills for inert waste, nonhazardous waste and hazardous waste. Regulations define waste acceptance criteria for each of the three categories, based on the waste type, testing of chemical composition and leachability of pollutants (Section 4.3.3). Wastes may need to be treated to achieve the acceptance criteria.

In the past and in areas with less-developed infrastructure, hazardous and nonhazardous waste has been disposed of together (codisposed), based on the assumption that the nonhazardous waste helps to attenuate the migration of pollutants. However, these mechanisms are neither well understood nor controllable, and the separation of waste types is therefore generally perceived as a better form of environmental protection than codisposal.

Mine tailings represent the largest quantities of land disposal. These wastes are generated from mining and mineral processing of copper, gold, iron, phosphate, lead, zinc, nickel, platinum group elements, bauxite and other metal ores. Approximately 16 Gt of tailings were generated in 2020 – about eight times the mass of MSW – with the global accumulation in tailings impoundments estimated to exceed 280 Gt. The features of tailings impoundments differ from those of engineered landfills.

- Tailings are emitted from mineral processing as a pumpable slurry, comprised of rock that has been finely ground to release the valuable metals. The impoundment must be able to contain a liquid, though the tailings settle out to a higher solids content over time.
- Tailings are generated in such large quantities that they are often disposed of in natural valleys instead of manmade impoundments. The valleys are unlined, with dams holding back the tailings at either end.
- Acidic leachate from tailings contains high concentrations of toxic metals which are generated when sulphidic rock is oxidised by *Thiobacillus ferrooxidans*. Tailings are therefore sometimes disposed of underwater, to avoid their oxidation.

Unfortunately, over the past century, there have been hundreds of catastrophic failures of improperly designed or managed tailings dams, which has led to the loss of thousands of lives and major cases of environmental contamination (Islam and Murakami 2021).

Other types of industrial waste may also be disposed of in (much smaller) surface impoundments, including on-site ponds (for liquids) or landfills (for solids). Ideally, they are lined to prevent seepage of contaminated leachate. In the past, waste was often collected in surface impoundments for further treatment, but ultimately abandoned. Waste surface impoundments are one of the main causes of contamination at old industrial sites. Today, it tends to be far more difficult to get a regulatory permit for an on-site surface impoundment.

Deep-well injection is used for liquid waste or slurries from a variety of industries. Arguably the best application of deep-well injection is for waste that cannot easily be treated, such as desalination brines and radioactive wastes, and even the geological sequestration of CO<sub>2</sub>. With deep-well injection, waste goes far down into geologically isolated porous layers of the subsurface (Figure 8.14). The well and the subsurface layer must not be connected to the surface or groundwater to prevent the movement of pollutants. Deep-well injection is controversial since it is difficult to verify that the subsurface layers are not connected. Moreover, the injection of liquids under pressure may cause fracturing of rock, connecting previously separate layers. Leakage can also occur when the well casing corrodes. Finally, deep-well injection may cause earthquakes in seismically sensitive areas.

### 8.6.2 Backfilling and land application

With backfilling, suitable waste is used to fill excavated areas. Backfilling may be a structural necessity to avoid the collapse of underground caverns created by mining, which would endanger structures on the overlying surface. Backfilling can also be necessary to level and fill building sites to provide a geotechnically stable base for construction. Waste can also be used for landscaping, for example, to create berms that screen local residences from road noise or embankments for planting along a pathway.

Since landfills are traditionally located in excavated sites, such as quarries, it can be difficult to clearly distinguish between backfilling and landfilling. Backfilling must meet two main criteria.

1. It must have a useful purpose normally fulfilled by a non-waste. For instance, preventing the collapse of mines may be essential, whereas raised areas for plantings (landscaping) can be purposely designed to use up excess material.
2. There must be an acceptable risk of environmental harm. Backfill materials resemble uncontaminated natural materials to a variable extent. If they contain even small amounts of potential pollutants, the risk for harm to humans or ecosystems must be assessed.

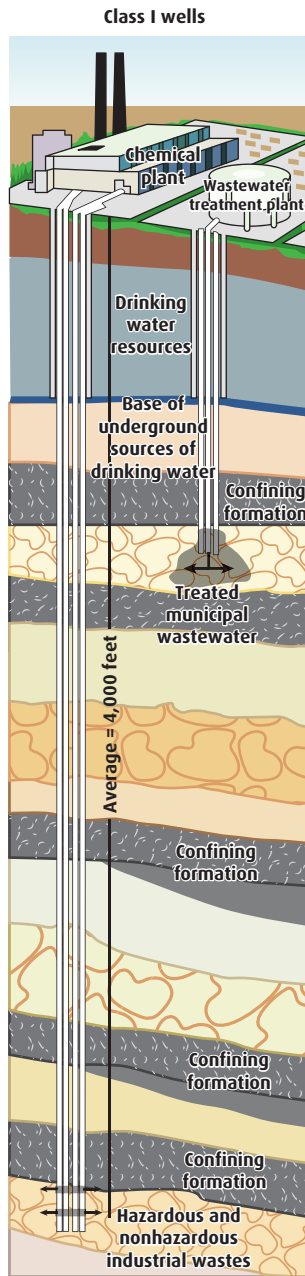

**Figure 8.14 Schematic diagram of USEPA Class I Industrial and Municipal Waste Disposal Wells for deep-well injection of hazardous and nonhazardous waste.** Redrawn from US EPA (2022).

Backfilling is usually considered distinct from, and less desirable than, recycling, because the latter results in a product with far greater functionality (Section 7.6.4 lists other operations that are not quite recycling).

Land application involves spreading waste on land. In the past, disposal has been the main objective of land application, but there can be a treatment benefit for organic waste, as organic compounds may undergo biodegradation in a soil environment. Volatile compounds may also evaporate from wastes spread on land, but this potentially results in air pollution. In modern practice, waste is only spread on land if it is expected to benefit soil quality. Landspreading may be restricted to the growing season to avoid runoff of excess nutrients to surface and groundwaters. Examples of wastes applied to land include:

- sewage sludge to provide nutrients and organic matter to the soil;
- wastepaper sludge to provide organic matter to the soil and to improve soil structure and water retention;
- ceramic industry wastes and drill cuttings from the oil and gas industry, which contain clay, to increase water retention.

The advisability of spreading these or other wastes on land depends on the compatibility of the properties of the waste and the local soil. The soil's organic, mineral and nutrient contents, as well as its water-holding capacity, porosity and drainage properties, must be considered (see Exercise 8.4). In the best case, land application of wastes is not the first waste treatment but the final stage of waste cascading, in loops of declining value (Section 9.3.1), as part of a circular economy.

#### EXERCISE 8.4 FINDING THE PERFECT MATCH... BETWEEN WASTE AND SOIL

Consider the properties of the example wastes listed above for land application (you may also find other examples to consider in the academic and grey literature). What would be the characteristics of soils and sites where these might be used beneficially? What potential pollutants would need to be considered in each case?

## 8.7 SUMMARY

This chapter discussed the main alternatives that remain for the management of waste when reuse or recycling are not possible. For wastes that are of predominantly biological (including fossil) origin, energy recovery is possible and often desirable. For inorganic wastes, land disposal is the only remaining option.

The most common energy recovery process for MSW is mass-burn incineration. Waste is combusted at high temperatures to destroy organic pollutants, and the heat may be used for electrical generation and district heating. The resulting bottom ash is often utilised as an aggregate after the recovery of metals. Fly ash is captured by air pollution control systems together with salts arising from acid gas removal. It is usually managed as hazardous waste.

Anaerobic digestion recovers energy from organic wastes by breaking down organic matter to produce methane and  $\text{CO}_2$ . The biogas can be combusted directly as a fuel or purified for injection into the natural-gas grid. After anaerobic digestion, a digestate slurry remains, which can be a valuable source of nutrients when added to the soil. Anaerobic digestion can also be a stage in a biorefinery to produce higher-value organic chemicals from waste.

The most common land disposal option is landfill. Older landfills were merely convenient holes in the ground, but modern landfills feature lining, capping and drainage collection layers to prevent leaching and to collect landfill gas. To some extent, landfills can be considered storage repositories for materials that can be recovered at a later date by landfill mining.

Other types of land disposal include surface impoundments, such as tailings ponds and on-site facilities managed by waste generators. Backfilling of excavated areas, landscaping and land application of waste tread the line between recovery and disposal. To be a true form of material recovery, backfilling or landspreading must replace non-waste that would otherwise be used for this purpose and avoid causing environmental harm.

## **8.8 REVIEW**

1. What are the main processes used for recovery of energy from waste?
2. What is the difference between the higher heating value, lower heating value and gross heating value of a fuel?
3. What are the main stages of mass-burn incineration? Can you explain how they are linked in a simple flow diagram?
4. What are the objectives and processes in cleaning flue gas from MSW incineration?

- 5.** Why does biomass decompose at different rates and how can pretreatment of the feedstock for an anaerobic digester help it decompose?
- 6.** What are the different stages in the breakdown of organic matter by anaerobic digestion?
- 7.** What is the composition of biogas and how can it be upgraded for injection to the natural-gas grid?
- 8.** What are the key features of a modern engineered landfill? How is it different from a traditional waste dump?
- 9.** What processes occur in a landfill over time, and what are the emissions that result?
- 10.** What are the two main criteria that are used to assess whether backfilling and land application of wastes are truly recovery processes, rather than disposal?





# 9

# THE CIRCULAR ECONOMY

## LEARNING OBJECTIVES

After studying this chapter, you should be able to:

- explain the idea, concepts and principles of a circular economy
- describe the main types and purposes of material loops
- explain the major strategies for achieving a circular economy
- explain how a transition to circularity may take place
- reflect on challenges and limitations regarding circularity

## 9.1 INTRODUCTION

---

This book started by describing the wider context of waste management, which is the complex system of production and consumption. It then discussed many aspects of waste management in great detail, often with consideration of the relevant background but without zooming out very far. The present chapter returns to the wider context of waste management and the efforts to reshape it for environmental, economic and social purposes. This effort has been gaining ground for at least half a century, culminating in the present effort to achieve a circular economy.

A circular economy is an economic system that aims to achieve sustainability goals through more efficient and circular use of materials. It is expected to protect the environment and bring additional economic and social benefits. A circular economy replaces the linear model of take-make-dispose with a model in which materials and products are used more intensively, for longer, and repeatedly. The achievement of this model requires great changes in product design, business models, supply chain management, government policy and waste management.

This chapter is partly about a new topic – the circular economy – and partly a summary of all the previous chapters, but using the terminology of the circular economy. By looking again at familiar themes, it aims to create a better understanding of them, and offers new concepts that build on and tie together what we have already discussed. For example, the chapter returns to waste reuse and recovery when discussing the concept of industrial symbiosis, which describes the exchange of waste as a resource between colocated industries.

[Section 9.2](#) summarises the main characteristics of a circular economy and the desired environmental, economic and social outcomes. The chapter then turns to the concept of material circularity: the types of loops and activities, the measurement of circularity and its limitations ([Section 9.3](#)). [Section 9.4](#) turns to practical strategies for achieving circularity. Finally, [Section 9.5](#) discusses the transition towards circularity and reflects on the long-term development of production and consumption beyond the limitations of a circular economy.

## 9.2 SUSTAINABILITY GOALS

### 9.2.1 Circularity in brief

Figure 9.1 compares a linear economy with a circular economy. The building blocks of the comparison are the lifecycle stages of products and services: extraction, production, use and waste disposal. In a linear economy, the succession of lifecycle stages implies an irreversible transformation of raw materials into waste, with only a minor fraction of material escaping disposal through recycling. By contrast, in a circular economy, products are reused or shared, and repaired or remanufactured. Together with increased recycling, these activities minimise material extraction and waste disposal.

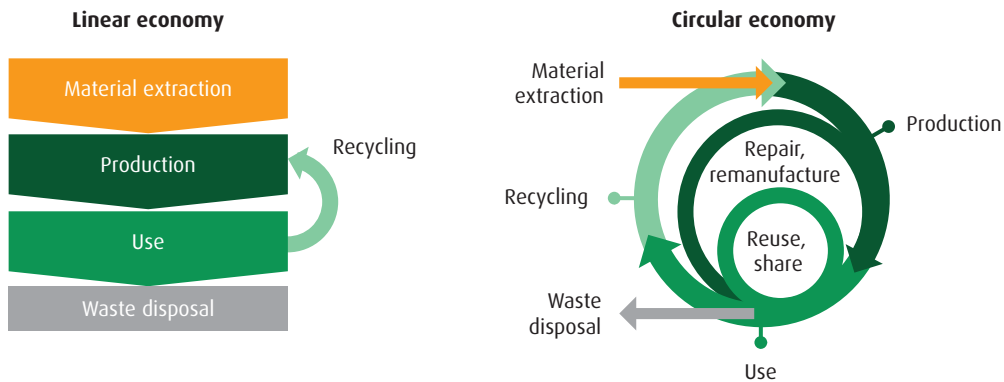

**Figure 9.1 A linear economy and a circular economy.** Image: Authors' own.

The idea presented in Figure 9.1 must appear familiar because it provides the conceptual foundation for this book, as already announced by its title. A circular economy, and much of the content of this book, is built on the following three premises:

- The economy and society are embedded in the natural environment, which is finite and supports our wealth, health and wellbeing.
- The socioeconomic metabolism of modern societies plays a crucial role in their functioning and has operated in a mostly linear fashion.
- The efficient and circular use of materials may reduce the environmental impacts of societal metabolism and offers additional economic and social benefits.

In this book, we present the circular economy as an effort to achieve sustainability (as defined in [Section 2.2.1](#)). However, circular economy is a broad and flexible concept that stems from a long tradition of environmental thinking ([Box 9.1](#)). Many proponents of circularity pursue mostly economic outcomes. The social dimension of sustainability tends to receive the least attention, and often only from a narrow economic understanding of wellbeing that focuses on jobs and income. The next few sections discuss the role of a circular economy for all three dimensions of sustainability.

### BOX 9.1 THE INTELLECTUAL HISTORY OF CIRCULAR ECONOMY

The term circular economy is relatively new, but the concept and its foundations go back at least half a century. The three basic premises listed in this section were already discussed in the 1960s and 1970s. Consider, for example, the following passage from *The Economics of the Coming Spaceship Earth* (1966), an essay by economist Kenneth E. Boulding, whose ideas reached far beyond the boundaries of his discipline.

*For the sake of picturesqueness, I am tempted to call the open economy the 'cowboy economy,' the cowboy being symbolic of the illimitable plains and also associated with reckless, exploitative, romantic, and violent behavior, which is characteristic of open societies. The closed economy of the future might similarly be called the 'spaceman' economy, in which the earth has become a single spaceship, without unlimited reservoirs of anything, either for extraction or for pollution, and in which, therefore, man must find his place in a cyclical ecological system which is capable of continuous reproduction of material form even though it cannot escape having inputs of energy.*

What do you think of Boulding's terminology? Would you prefer to call a circular economy a 'spaceman economy'?

After Boulding, other thinkers introduced concepts that further developed and popularised the ideas that underpin a circular economy. These concepts include biomimicry, cradle-to-cradle, the performance economy, the blue economy, natural capitalism and regenerative design.

The essay by Boulding, and the concepts listed above, present only a limited view of how the circular economy relates to historical perspectives on wellbeing and the environment. When interpreted more broadly, the antecedents of the



circular economy can be traced back further than the 1960s and include, for example, the ideas of environmental stewardship presented in the sacred texts of various religions.

Industrial ecology is the academic discipline most closely associated with the circular economy. Industrial ecology is concerned with the energy and material flows in society, their impacts on the natural environment, and the potential for sustainability through ecological cycling of resources. The field plays an important role in the promotion of waste prevention and recovery, the development and application of MFA, LCA and EEIO ([Chapter 3](#)), and the formulation of circular strategies ([Section 9.4](#)).

Source: Boulding (1966).

### 9.2.2 The environment

To achieve the environmental dimension of sustainability, a circular economy needs to respect at least three major principles. The first principle is sustainable yield; the rate at which we extract materials should not exceed the rate at which materials regrow. Sustainable yield requires good knowledge of total material stocks, removal rates and rates of regrowth. Sustainable yield should consider not only the quantity, but also the quality of the stocks. For example, replacing an old-growth forest with a plantation may ensure a steady supply of timber, but it is likely to lower carbon storage and does not preserve biodiversity.

Nonrenewables do not regrow, and their depletion is only a matter of time. The second principle states that stocks of nonrenewables should, in the long run, be substituted with stocks of renewable materials. For example, the depletion of minerals for construction can be addressed through afforestation for greater production of construction timber. Substitution between different types of nonrenewables, for example, between different types of metals, can postpone the need to shift to renewable materials. More efficient use of nonrenewable materials can also postpone their depletion.

Finally, a circular economy should respect limits to the environmental pressures that ecosystems can endure ([Section 2.2.2](#)). Ecosystem protection is necessary to preserve a healthy and pleasant environment, including, for example, clean air and biodiversity. However, the concept of a circular economy is tailored to addressing environmental pressures directly related to material use; it is not a comprehensive strategy for all manners of environmental protection. For example, the concept has relatively little to say about water management or habitat conservation.

### 9.2.3 Economy

The potential economic benefits of a circular economy are a powerful driver of its popularity. In the long term, the economy should gain from the protection of the natural environment, because it critically depends on it for the provision of natural resources. In the short term, benefits may also be expected in the following forms:

- *Cost-savings.* The extended, repeated and intensified use of materials can reduce virgin material demand and thus the input costs for businesses' activities. For example, a glass bottle manufacturer can save on raw material inputs by taking back bottles and recycling or reusing them.
- *Price volatility.* Raw materials prices can be volatile, which exposes businesses to the risk of rapidly increasing input costs, which are unlikely to be shouldered by the consumer. A greater reliance on locally available resources may lead to more stable input costs.
- *Criticality.* As discussed in [Chapter 7](#) for metals ([Section 7.3.3](#)), recycling responds to concerns over criticality, and so do other circular activities like reuse and remanufacturing, because they all reduce the dependence of manufacturers on raw materials.
- *Marketing.* Businesses expect to gain from an increasing demand for circular products and services. Circular business models, such as rental instead of ownership, are lucrative when consumers are willing to pay for the expected environmental benefits.

The actual economic benefits of circularity depend greatly on the specific business and market. Moreover, not everybody can win. When increased recycling reduces the dependence of manufacturers on virgin materials, it implies lower revenues for virgin material producers. Virgin material providers are unlikely to gain in a circular economy unless they radically transform their businesses. However, within primary industries, circular economy practices may bring joint environmental and economic benefits, such as cost savings through waste prevention.

### 9.2.4 Society

A circular economy has the potential to address some of the profound social impacts of production and consumption, although the concept is more often promoted for its potential environmental and economic benefits. Circularity would, ideally, not only benefit the economy and the environment, but also achieve the following:

- *Wellbeing.* A thriving economy does not guarantee good health and wellbeing, which depend on the fulfilment of basic materials needs such

as food and shelter, good physical and mental health, freedom of choice, a fulfilling social life and safety and security. Key drivers of a lack of wellbeing include job insecurity, lack of community, lack of good food and exercise and material poverty, none of which are completely absent in any country, and are thus a potential priority for a circular economy.

- *Economic equality.* A circular economy aims to develop the economy without overburdening the environment – but to whose benefit? Potential benefits of a circular economy are investment in disadvantaged communities, good-quality jobs in new industries and fair access to natural resources. For example, a shift to renewable materials should benefit global providers of such materials, which include many low-income countries, and not just the foreign corporations that dominate these industries.
- *Social equality.* Environmental pollution is known to affect vulnerable communities more often, especially in the context of local waste disposal and the global waste trade. The historical increase in recycling was partly supported by informal recycling practices in low-income countries, often under questionable health and environmental conditions. A circular economy should not entrench such practices but provide alternative ways of circulating materials that benefit people up and down the value chain.

Many high-profile circular economy efforts deliver some, but rarely all, of the above. Think, for example, of the following practices that may be deemed circular:

- Ride-hailing services are often considered circular because they may increase the intensity of use of cars and reduce car ownership. However, the services replace traditional taxi driver jobs that offered more security, shorter hours and better pay.
- Online shops can be considered circular because they save on retail space. However, online shopping can bankrupt local retailers, make town centres and high streets less vibrant and consequently weaken the ties between members of a local community.

The environmental benefits of the above two examples are probably as debatable as their social impacts; ride-hailing can reduce the use of more environmentally friendly public transport and online shops lead to additional traffic for home delivery. However, the main point of the examples is to show that activities are



sometimes considered circular because of a presupposed environmental benefit, without even considering the social impacts.

A circular economy may not be the most comprehensive approach to sustainability, especially regarding the social dimension, but it is relevant nevertheless. The circular economy is therefore also relevant to the Sustainable Development Goals (SDGs), arguably the most comprehensive global effort to formulate the desired social, economic and environmental course for humanity. [Box 9.2](#) explains the SDGs and invites you to find the linkages from the goals to waste management and the circular economy.

### BOX 9.2 THE SUSTAINABLE DEVELOPMENT GOALS

The Sustainable Development Goals (SDGs) are a set of global goals to end poverty, protect the planet and ensure peace and prosperity for everybody. The goals were agreed in 2015 by the United Nations General Assembly and are intended to be fulfilled by 2030. Besides the 17 goals, there are 169 global targets, many of which relate directly or indirectly to waste management and the circular economy.

The goals show that sustainable development is a more comprehensive concept than the circular economy, but also that advances in waste management and circularity can contribute to the achievement of the goals. [Figure 9.2](#) provides an overview of the goals.

Even though waste management and the circular economy are not mentioned explicitly, there are clear linkages. For example, Goal 12 aims for responsible consumption and production. The targets for this goal cover, among others, the efficient use of natural resources and the reduction and recycling of waste. Some targets have been specified quantitatively; by 2030, per-capita global food waste must be halved. This target includes waste from the entire lifecycle, along the production and supply chain, including retail and consumers.

Which other goals do you expect to relate to waste management and the circular economy? To check your intuitions, search online for the detailed descriptions of the goals and the associated targets. Do the goals align with the goals and practices of a circular economy? Can you imagine a circular economy that fulfils all the goals? If it did, should it be called a circular economy or, rather, sustainable development?





## 9.3 MATERIAL CIRCULARITY

### 9.3.1 Material loops

Circular-economy thinking often distinguishes between two types of materials or ‘nutrients’ in the economy: biotic and abiotic. [Figure 9.3](#) shows two sets of loops on either side of the product lifecycle, which runs from top to bottom, in what is often called the butterfly diagram. On the left-hand side are the biotic materials, also called renewable. They include materials that can naturally decompose, such as food, timber and bio-based plastics. On the right-hand side are the abiotic materials, also called nonrenewable or finite. Examples include steel, sand and glass. These materials cannot decompose but may be recycled in industrial processes.

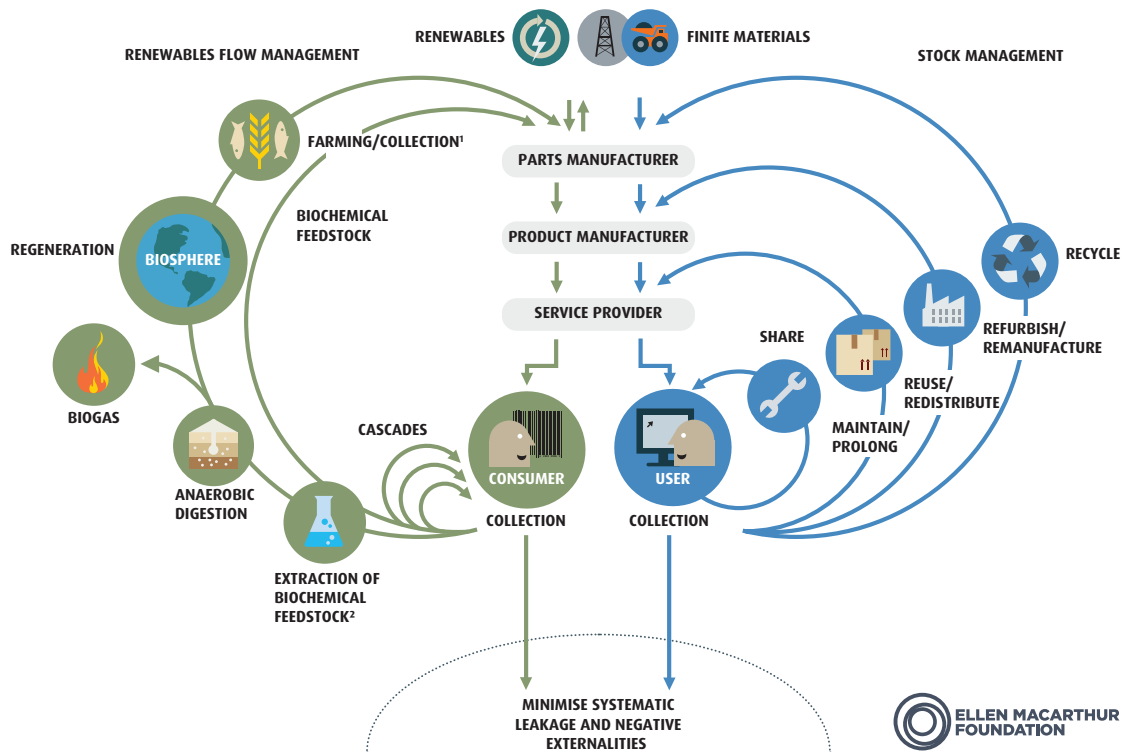

**Figure 9.3 The butterfly diagram of a circular economy.** Copyright © Ellen MacArthur Foundation, Circular economy system diagram (February 2019).

At the top of the diagram are the primary inputs (renewables and finite materials). At the bottom of the diagram are the final outputs (leakage), which include waste to landfill. On either side of the diagram are various loops that depict familiar activities, such as reuse and energy recovery. The narrower loops are generally considered preferable to the wider loops because they tend to be more environmentally friendly. The prioritisation of the narrow loops is consistent with the waste management hierarchy and a central aspect of a circular economy.

The diagram emphasises the differences between narrow and wider loops, but we can make further distinctions between types of loops based on speed, order and geography.

- *Slow and fast loops.* Slow loops may be considered more attractive than fast loops; the longer a material stays in the economy before being circled back, the less effort this requires per unit of time. An example of a strategy to slow down loops is product life extension. Conceptually, it can be hard to separate strategies like reuse from slow use. Generally speaking, though, a

quick succession of product circles may appear circular but requires large amounts of energy and materials (to compensate for, e.g., yield losses).

- *Successive loops (cascading)*. Cascading refers to the subsequent use of material in various loops. The figure shows this only for biotic materials, but it applies to abiotic materials too. For example, a product may be reused first, then recycled several times and, after the material is too worn for further recycling, it may be burnt for energy recovery. This temporal aspect is not visible in the diagram, but it would naturally start with the narrower loops and proceed to the wider loops (i.e., cascading also adheres to the waste hierarchy).
- *Local and global loops*. Local loops may be preferable to global loops because they require less transport and support greater consumer engagement with the origin and impact of products. The idea of local consumption has an important role in sustainability thinking and is worth exploring in the circular-economy context. For narrow loops like reuse and repair, keeping things local can be especially important, because it could be too costly or impractical to transport materials and products for these purposes.

Each loop in [Figure 9.3](#) has an origin (e.g., user) and destination (e.g., product manufacturer). The labels describe the relevant activity (e.g., reuse), which is the subject of the [next section](#).

### 9.3.2 From the three Rs to the 10 Rs

The loop-closing activities in the butterfly diagram can be interpreted as priorities within an expanded version of the waste hierarchy. The older versions of the waste hierarchy often listed only the three Rs of reduce, reuse and recycle. Many of the more recent versions also distinguish, among others, energy recovery and composting as separate priorities. A much longer list of 10 Rs describes the priorities in a circular economy (Potting et al. [2017](#)).

1. *Refusing* to buy a product by using another product instead, or even letting go of the product functionality altogether. For example, refusing a disposable cup by bringing a reusable cup, or having coffee at home.
2. *Rethinking* how a product is used to enable sharing. For example, rethinking housing and hospitality by renting out unused rooms to short-term visitors, as an alternative to dedicated hotels with higher impacts.

3. *Reducing* material use and waste by improving the efficiency of production and product designs. For example, designing lightweight building components that require less materials and take less energy to be transported.
4. *Reusing* products after a previous owner does not want them anymore, but before they have lost their functionality or appeal altogether. For example, trading used clothing and books through second-hand stores or online platforms.
5. *Repairing* defective products, including through regular maintenance, to ensure their functionality is kept for longer. Examples include regular check-ups of equipment, such as cars, or returning broken items to the manufacturer for repair.
6. *Refurbishing* an older product to update critical aspects of its performance while maintaining all aspects that are still in good order. For example, refurbishing phones or tablets by replacing only the battery and the outer shell.
7. *Remanufacturing* of complex equipment by combining new and used parts, some of which may have been repaired or refurbished. For example, rebuilding a car engine with parts from used engines, as well as new components.
8. *Repurposing* a product or component by finding a different use for it. For example, using railway sleepers to construct raised flower beds, or using car seats from end-of-life vehicles as office furniture.
9. *Recycling* materials by taking them apart and rebuilding the original material. The most widely recycled materials are metals, glass, paper and plastics. Organic materials can be recycled through composting.
10. *Recovering* the energy content of materials through thermal treatment while capturing heat or converting them into fuels. A common form of energy recovery is the generation of electricity and heat from the combustion of MSW.

A circular economy aims to maximise the benefits from material use over time, which means that some materials may be subjected to one of the Rs repeatedly, or to several different Rs in succession. This was already introduced as cascading in the [previous section](#). [Exercise 9.1](#) invites you to think more about the potential for cascading with the 10 Rs.

### EXERCISE 9.1 APPLYING THE 10 RS

Electric vehicles and their batteries are complex products of high value. Various Rs may be applied to minimise environmental impacts and maximise economic benefits. Discuss the following questions.

- Which of the Rs are relevant to the vehicle and the battery? Would it make sense to apply a different R to each?
- For the battery, which of the Rs may be applied consecutively? In which order should the Rs be applied to maximise the benefits?
- Can you think of any activity that extends the life of the vehicle or the battery, but that is not already listed in the 10 Rs?

### 9.3.3 Value creation

The circular economy is motivated by the observation that many common activities destroy material value. For example, by design, disposable plastic cutlery renders the material unusable after a very short life of limited functionality. Even if the plastic is recycled, it yields secondary material of lower quality and value (except with ‘upcycling’; [Box 9.3](#)). Plastics are often burnt and, though the energy may be recovered, the residuals are typically landfilled. Such processes of value destruction are largely irreversible; it is technically not feasible to recycle without loss of quality or to turn incinerator ash into new plastics.

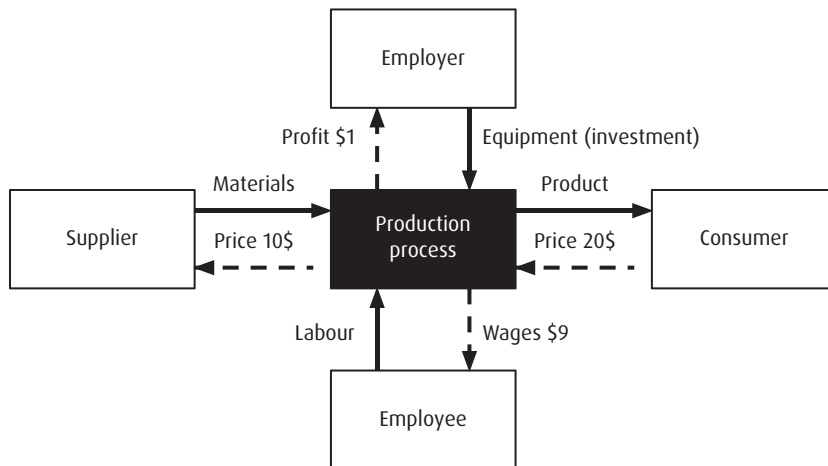

**Figure 9.4 Value creation from material production.** Image: Authors' own.

This section discusses how value can be maintained instead. [Figure 9.4](#) shows a simple economic balance of a production activity. The activity turns \$10 of material into a \$20 product. The value addition of \$10 is realised by an investor providing the equipment (e.g., a factory with machines) and an employee operating the equipment. The employee is paid wages and the investor receives part of the profits in return for the investment. The figure leaves out many of the complexities of production and does not account for taxes or depreciation, but it captures the essence of value creation.

The maintenance of value in a circular economy can be interpreted as maximising the added value. Based on [Figure 9.4](#), this amounts to maximising the sum of profit and wages for a given material input. The following strategies may work:

- Producing more products from the same inputs through, for example, more efficient production or lightweight product design. This works only if the required additional investment or labour is smaller than the potential savings on material inputs.
- Producing products again from the same inputs through, for example, recycling of the product at the end-of-life. This works only if the recycled product, which tends to be of lower quality, can still be sold at a price that covers the cost of recycling.
- Providing more product functionality based on the same input by, for example, renting the product to several users instead of selling it to one person. This works only if consumers are willing to pay enough for renting the product instead of owning it.

While the above strategies can maintain value, none is beneficial to the material supplier, who stands to lose when material purchases are reduced. This raises important questions for a circular economy. Value for whom, when and where? In an economy that strongly depends on mining and extraction, can circularity increase added value? These questions have different answers for the short term and the long term; while the extractive industries may suffer from circularity, it also ensures that the economy is less dependent on finite resources in the long run.

### BOX 9.3 LIMITS AND OPPORTUNITIES FOR UPCYCLING

Upcycling refers to the use of waste in an application that is of higher value than the original product. This contradicts the conventional wisdom that materials become less valuable with every use because of contamination and wear. However, the value of products depends on many different aspects, which opens up possibilities for value creation. Secondary materials may be used in higher-value applications when at least one of the following conditions applies:

- The consumer is willing to pay more for the secondary product because of the expected environmental savings. For example, consumers may be willing to pay more for a recycled bottle than a bottle from virgin plastic.
- The consumer values the distinctive history and appearance of the secondary product. For example, locally sourced secondary wood can give a new house an attractive weathered look and can symbolically connect the building to its surroundings.

Often, the two go together. [Figure 9.5](#) shows wallets, handbags and other accessories made from discarded food packaging sold at a store in Lisbon, Portugal. Each of the colourful products has a unique design, and its history can be read from the snippets of text and logos on the materials that were used. Consumers are willing to pay a premium for this, especially if the concept is new to them (which it will not be forever). It probably helps that the shop is in a tourist district, where consumers tend to look for authenticity and local character when buying something. The bags have environmental credentials too. Instead of sourcing primary materials, the shop receives discarded packaging from nearby residents and converts it on-site into new products. Most of the packaging would have been incinerated or landfilled otherwise.

However, at the time the photo was taken, waste deliveries outpaced demand, which illustrates the limits of upcycling. Just consider how many handbags and other accessories could be made from the food packaging that we throw away every year – many more than can be expected to get sold. Perhaps the packaging waste can be upcycled into products other than those shown in the image. But once the novelty of using old packaging for new products wears off, the seller cannot charge a premium for it. At that point, upcycling is likely to become downcycling again.







**Figure 9.5** These accessories are worth much more than the discarded packaging material they are made of. Image: Authors' own.

### 9.3.4 Limits to circularity

Circularity holds great promise, but it is not a silver bullet. [Chapter 7](#) discussed the limits to recycling ([Section 7.2.4](#)). Similar limits apply to the broader range of activities promoted in a circular economy (the 10 Rs in [Section 9.3.2](#)). The following constraints prevent the creation of a perfect circle without waste:

- All circular-economy activity, even the higher priorities of reuse and repair, require energy to implement, including for transport, cleaning and disassembly. Though reuse and repair save energy compared to making new products, energy is required still. Any R that is implemented widely will need substantial energy inputs, which raises questions regarding its

generation and supply without excessively burdening the environment and people.

- Many materials are not available to be circled back into the economy. Some materials are dissipated by design, such as fireworks, or through wear and degradation, such as the corrosion of metal structures. Moreover, plenty of materials are kept in-use indefinitely, such as roads, whose top layers have to be renewed at regular intervals, but whose foundational layers are likely to remain in place indefinitely.
- Leaving aside that materials and products are dispersed or locked in use, their circulation is rarely 100-per-cent efficient. No product can be shared by an infinite number of people, reused an infinite number of times or repaired forever. Circularity, therefore, only delays disposal, unless the product is biotic and can be fully decomposed. In the long term, it is therefore necessary to shift towards biotic materials.
- Even if all the above did not apply, global growth in consumption, driven by a growing number of people and greater prosperity ([Sections 1.2.2](#) and [1.2.3](#)), still poses a challenge. We cannot keep reusing and repairing the same products if tomorrow we want to have more products for more people. To address the gap between supply and demand of secondary materials, the manufacturing of new products will require at least some virgin material.
- All the above limitations are exacerbated by changing fashion and technology, which means that yesterday's products, even if still technically functional, may not be desirable today. Modern consumers expect rapid change in product performance and style, which can hardly be achieved when trying to use products or their components for longer, or when repeatedly circulating the same materials through recycling.

Finally, there is the problem of the rebound effect. When waste prevention reduces the cost of a product, it can be sold at a cheaper price, which often means we buy more of it. This is called the direct rebound. Alternatively, we may spend the money we saved on other goods that have environmental impacts too. This is called the indirect rebound. Altogether, rebound offsets some of the gains that may be initially expected from an increase in efficiency, and in rare cases can completely cancel out the savings. [Box 9.4](#) illustrates the rebound effect for reuse of smartphones.

### BOX 9.4 REBOUND EFFECTS OF BUYING A USED SMARTPHONE

Intuitively, the following statement is true: when buying a used smartphone, you save the environmental impacts of producing a new one. Unfortunately, the reality is more complicated. A buyer of a second-hand smartphone should expect the rebound effect to offset some of the savings of avoiding a new product. Let us assume the buyer chooses between a used or new smartphone of exactly the same brand and model.

- The used smartphone probably has declining battery performance, so its remaining use life is shorter than for a new smartphone. If the used phone is kept only half as long, it means two used phones substitute just one new phone.
- The used smartphone is likely to be cheaper than the same model new. The saved money will be spent on something else, which leads to environmental impacts that will partly or wholly offset the gains of not buying the new phone.

The used phone could also be an alternative to a different model that costs the same new, or another used phone costing the same. In either case, the consumer is substituting another type of phone and the savings depend on the relative impacts of the models. It is also possible the buyer was merely considering whether to buy the second-hand phone or not. In this case, the alternative is to spend the money on a range of goods, perhaps food or transport.

Whatever the substitution, the savings from not buying a new phone may be partly or fully negated by the direct and indirect rebound effect. In addition, complex market dynamics can create a wider ripple effect. For example, the purchase of a used phone could strengthen the second-hand phone market and help convince producers to invest in refurbishing programmes. This could increase the positive impact of buying second-hand beyond the immediate substitution effect.

So, how to deal with rebound as a consumer? Generally speaking, you have to worry less about rebound if you consistently avoid the most harmful products and instead buy the least harmful products. For example, if you want to lower your carbon footprint, aim for low-carbon products in any spending category. This prevents you from inadvertently substituting, for example, high-impact travel (e.g., flying) with high-impacts foods (e.g., red meat).

Source: Zink and Geyer (2017); Makov and Font Vivanco (2018).

## 9.4 CIRCULAR STRATEGIES

### 9.4.1 Levels of action

The previous sections discussed circular-economy activities such as repair or reuse. These activities do not occur in isolation, but need to be embedded within broader strategies to ensure success. For example, for product-sharing to be successful, it requires the design of durable products, business models for offering shared products to consumers and appropriate regulatory frameworks to define rights and responsibilities for shared products.

Circular strategies can be identified at three hierarchical levels.

- *Micro-level.* This lowest level pertains to individual products or businesses. Relevant strategies include product design and business model innovation.
- *Meso-level.* This middle level relates to activities across businesses. Relevant strategies focus on improving supply chains and industrial symbiosis.
- *Macro-level.* This top level refers to decision-making at the city, region, national or global level to monitor and support micro- and meso-level activity.

The micro- and meso-level strategies are described in the subsequent sections on product design, business models, supply chains, reverse logistics and industrial symbiosis. [Section 9.5](#) discusses how to monitor progress towards circularity across the three levels and discusses interventions at the macro-level that support a transition towards a circular economy.

### 9.4.2 Product design

At the micro-level, circular economy activities depend on product design, which should aim to maintain the utility and value of materials and products and consider impacts across the full lifecycle. This means designers have to engage with sellers, users and waste managers to create products that support at least some of the activities described by the Rs. Circular design involves at least the following aspects (further examples are given in [Box 9.5](#)):

- *Material choice.* Avoiding scarce, toxic and nonrenewable materials can reduce impacts from production, use and end-of-life. For example, petrol-based plastics that cannot be recycled and release hazardous substances may be replaced with bio-based materials that can be composted and do not contain hazardous additives.

- *Material intensity.* Using less materials through improved product design can reduce impacts across the lifecycle, from raw material extraction to end-of-life waste management. For example, lightweight design of cars requires less mining of metals, results in cars that need less energy to move around and generates less waste after scrapping.
- *Recycled content.* Using more materials that were recycled, instead of mined, can reduce the impacts of raw material processing. The reprocessing of recovered metals, plastics, glass and steel tends to have lower impacts than primary production.
- *Processing.* Improving process technologies can achieve lower yield loss, less use of chemicals and lower water requirements. For example, chlorine-free bleaching of paper products reduces impacts on the environment.
- *Product lifetime.* Designs with a long practical and social lifespan help products stay in use for longer, whether by a single user or through reuse. For example, clothing of durable, high-quality materials can be resold in the same market.
- *Intensity of use.* A design that enables sharing between users means demand can be met with fewer products. For example, public bike-sharing schemes rely on bike designs that are sturdy and can be used by people of (almost) all heights.
- *Recyclability or biodegradability.* Designs that include recyclable or biodegradable materials, and that are easy to take apart, can serve as inputs for a new generation of products. For example, single-material packaging is easier to recycle than multi-material packaging.

All the above design choices are meant to lower the lifecycle impacts of a product. Whether they achieve this depends greatly on how exactly the interventions are executed, which highlights the need for the repeated use of LCA for new products, instead of relying just on rules of thumb. Moreover, for product design to be successful, other actors in the supply chain need to do their part, starting with the business model of consumer-facing businesses, which is discussed in the next section.

### BOX 9.5 EXAMPLES OF CIRCULAR PRODUCT DESIGN

Circularity covers many aspects of product design. Consider the following examples taken from an online article. Which aspects of the product are emphasised? How do the actions correspond to the 10 Rs? Are the product designs really likely to be circular? If not, what alternative or additional actions may be taken to achieve better results?

*Timberland has partnered with Omni United, a tire manufacturer, and distributor to produce footwear using recycled tires. Footwear is one of the biggest users of virgin rubber. Once [Omni] Tires have reached the end of their product life, they are shipped to a recycling facility and turned into crumb rubber. This crumb rubber is processed into sheet rubber for the outsoles of Timberland shoes.*

*With a monthly subscription to VIGGA, customers get 20 pieces of children's clothing. Once the clothes don't fit anymore, they are returned and the customer receives another set one size bigger. In this system, the company has an incentive to design high-quality, long-lasting clothes that directly serve their bottom line.*

*Johnson Controls has managed to design a battery that is 99% recyclable, an incredible feat for a product so chemically complex and hazardous. By encouraging consumers of conventional batteries to recycle, the company received enough material to prevent hundreds of millions of batteries from ending up in landfills.*

As pointed out before, design choices cannot be separated completely from business models. In the above descriptions, which activities do you recognise that are not limited to the work of product designers? Which other business activities appear to be relevant? Do you recognise any critical factors that are not within the control of the business at all, but require the commitment of external stakeholders?

Source: Benzaken (2018).

### 9.4.3 Business models

A business model describes how a company plans to make a profit. This section focuses on the circular-economy activities that business models can enable, which include sharing, maintenance and repair, reuse, refurbishing and remanufacturing, recycling and the use of clean and biotic products. For each activity, we briefly discuss how the business model may offer value to the consumer and profit to the business.

- *Sharing.* Sharing businesses may own products and rent them out to consumers. Alternatively, they could focus on the sharing of consumer-owned products by providing a platform for coordination and payment. Consumers pay not for the product but for the service it provides, per unit of time (e.g., a car for a day) or functionality (e.g., transport kilometres). This can be of great value to consumers, especially if they do not need the product every day, have limited storage space and care less for the emotional bond offered by ownership. An added benefit of sharing can be the access to the latest technology.
- *Maintenance and repair.* These businesses sell a service to cost-conscious consumers and businesses that like to get the most out of their products. The service may be offered by the manufacturer of the product, as an element of the warranty provisions or a lease contract, or as a stand-alone service by a third party. The value to the consumer is in the extended enjoyment of the product. Repair and maintenance make most sense for high-value products that cannot be replaced cheaply. High-value products are expensive to buy, which calls for alternative payment arrangements, such as spreading the cost in a lease agreement.
- *Reuse.* Businesses can provide the coordination and logistics required for reuse through online platforms for the exchange of goods. Manufacturers may also take back and sell their own products, with the added benefit of expert evaluation of the product and potential minor repairs or cleaning. Value is captured by cutting out the early lifecycle stages. Added benefits of reuse include the fashion appeal of vintage products. A line of reused products may cannibalise new products, but also increase brand appeal and consumer loyalty.
- *Refurbishing and remanufacturing.* This can be offered by businesses that combine advanced capabilities in maintenance and repair, and in reuse, which is often the product manufacturer, but third parties could be involved too. Customers for refurbishing and remanufacturing can be other businesses, such as airlines getting jet engines updated, or consumers seeking to extend the life of high-value products such as furniture or even a home (i.e., building renovation). Value may be captured through cost savings and by avoiding the disruption of product replacement (e.g., no need to seek out new furniture).
- *Recycling.* Recycling businesses focus on the materials that make up the product and indirectly supply a service. They may focus on waste management, product design or both. The latter includes companies who take back their own products for recycling. Value may be captured from



cost savings on primary material inputs and the price premium that is often paid for green products. In rare cases, recycled content may improve the appeal of the product through a unique and fashionable appearance.

- *Clean or biotic products.* These businesses focus on clean cycles and biotic materials that can be decomposed. The use of clean and biotic materials requires innovative product design and manufacturing technology. Value may be captured by responding to consumer interest in green products and by lowering the costs of waste management and pollution control. Clean, renewable products are often expensive, but this partly results from the small production volumes and early stage of technology development. Clean and biotic products can be economical when it is costly to dispose of waste and pollute the environment.

Irrespective of the circular activity, the bottom line of businesses is to make a profit. Business models can therefore be characterised by their cost factors and revenue sources; the difference between the two is the profit. The following exercise dives into the economics of the above business models by analysing their costs and revenues.

### EXERCISE 9.2 MAKING A PROFIT IN A CIRCULAR ECONOMY

In the linear economy, smartphones are sold at a profit, owned for some time and then discarded. Alternatively, in a circular economy, businesses may offer smartphone functionality through any of the six activities listed above. For the linear business model and for the six circular business models, try to answer the following questions.

- What are the main investment and operational costs for the business?
- What are the main sources of revenue?

Reflect on the answers. Do the circular business models seem feasible? Under what conditions are costs likely to be lower and revenues higher? The conditions may be related to product design, consumer preferences or the regulatory context.



#### 9.4.4 Supply chains

Modern products require an extensive supply chain, which is comprised by the businesses involved in getting a product to the consumer, from raw material extraction to retail. Waste in the supply chain can have two origins: inefficiencies within businesses, which were already discussed in [Chapter 5](#), and waste that results from the complex interplay between businesses, which is the topic of the current section. The literature on supply chain optimisation talks about ‘waste’ to indicate a variety of losses, including time and money, but this section is about solid waste generation. The following are common causes of supply chain waste:

- *Overproduction or overstocking.* Anywhere in the supply chain, actors may choose to overproduce or overstock to make sure they can always deliver to their customers. Some of the products may be left unsold, which is most problematic for perishable goods. For example, restaurants overstock to make sure they can offer all the meals on the menu.
- *Late adjustment to orders.* To avoid unsold surplus, buyers may adjust orders at a late stage, but this can cause waste for the suppliers. For example, supermarkets may place large orders but reduce them at short notice based on actual sales. When the supplier has produced the goods already, the unsold fraction may get thrown (see [Box 9.6](#)).
- *Overspecification.* When the required or actual performance of a product is not fully known, product users may choose a high-performance alternative to be on the safe side. For example, in construction, it may be unclear what load a beam will need to support, or how strong the available beams are, so builders may just pick a very thick one.
- *Late-stage product adjustment.* When intermediate products are adjusted late in the supply chain, the waste may be difficult to reuse or recycle. For example, construction components may be cut to size on-site. When the components are instead cut to size in the manufacturing plant, the waste may be reused or recycled immediately.
- *Overly strict standards.* Buyers may demand products that meet very strict standards, leaving substandard products unsold. For example, retailers may demand perfectly sized fruits and vegetables, forcing farmers to dispose of oddly shaped produce. Strict standards are very problematic for food because size and colour are always different, and the unwanted items may perish before an alternative buyer is found.
- *Excessive packaging.* Different stages of the supply chain need different types of packaging, often related to the number of items transported together. Packaging may instead be designed to fit multiple stages. For

example, a bag of cereals or rice that is home-delivered does not need to come in a colourful box that was primarily designed to draw consumers' attention in a supermarket aisle. Another option is reusable packaging.

- *Lack of byproduct markets.* Several of the above issues could be avoided if there was a market for the left-over materials, such as for the oddly sized fruits and vegetables or the offcuts from a construction site. Well-developed networks of sellers and buyers of byproducts can potentially address the issue. Exchanges of byproducts can be more feasible when businesses are colocated, which will be discussed further in [Section 9.4.6](#) on industrial symbiosis.

Part of the solution to all the above concerns is better coordination between buyers and sellers. For example, supply chain partners could share information about their operations to align approaches to packaging, or to agree on product quality standards that are feasible for both buyer and seller. However, coordination can be difficult when there are many companies in a supply chain and each company has many different trading partners; each buyer–supplier relationship may present unique challenges of waste.

It is easier to reduce supply chain waste when buyers and sellers have a mutual interest in waste reduction. Such a mutual interest may arise when the cost of managing the waste falls on both parties. Unfortunately, the cost of waste management that occurs due to a lack of coordination often falls on just one of the parties. These costs may increase sales prices in the long term, which hurts buyers, but this is rarely sufficient to spur action. When other factors (e.g., labour costs) influence prices far more, waste is unlikely to receive much attention.

Waste is more likely to occur when a large number of suppliers (e.g., food producers) rely on a single customer (e.g., a supermarket). In this case, suppliers fear losing business when they start making demands ([Box 9.6](#)). Similarly, when many buyers rely on a single supplier, no single buyer has much influence over the supplier. In contrast, a competitive market with many buyers and sellers may stimulate companies to help their trading partners to reduce waste and win their loyalty. At the same time, competitive markets with many players are not conducive to building the kind of long-term relationships that support improved coordination.

## BOX 9.6 SUPPLY CHAIN WASTE OF SANDWICHES

The humble packaged supermarket sandwich is a lunch favourite in the UK, but a large fraction never reaches the consumer. In the book *Waste: Uncovering the Global Food Scandal*, Tristram Stuart explains why. First off, he notes that some retailers have very strict aesthetic requirements, demanding that sandwiches are not made from the crust of a loaf of bread, nor from the first or last slice. This leads to approximately 17 per cent of the bread being thrown.

The waste does not stop here. Some of the sandwiches get prepared but are never sold because of overproduction. Supermarkets may adjust food orders on the day of delivery, even if production is already in full swing. In extreme cases, overproduction leads to more food being wasted than sold. Selling the excess is difficult because sandwiches spoil soon. Few buyers are interested in sandwiches whose remaining shelf lives are relatively short because they were not immediately shipped from the manufacturer.

Moreover, many supermarkets sell sandwiches under their own label, which means the overproduced goods must be depackaged before sales to another customer. However, depackaging is very challenging because plastic fragments can end up in the food. Even if packaging were no issue, supermarkets may demand exclusivity and forbid the supplier from selling the same food to third parties because they fear it will undercut supermarket sales. Sometimes, the food is not even allowed to be given to charity.

Perhaps the worst phenomena in supply chain waste are take-back arrangements that require a supplier to take back any unsold food, even if there is no use for it. The supplier will discard the food, while the supermarket can claim it did not generate waste.

Why do supermarkets get away with this? Because they can. Food manufacturers often supply just to two or three customers, but supermarkets can easily switch between tens or hundreds of suppliers. Suppliers stay silent for fear of losing orders. The problem is not as bad for manufacturers that produce food under their own brand name. In this case, excess production can be sold to other buyers without repackaging. Moreover, supermarkets may be eager to keep a popular brand on their shelves, giving the supplier more power to negotiate.

Change is happening, sometimes despite opposition from supermarkets, and sometimes with the cooperation of supermarkets. Regulatory initiatives have targeted the takeback agreements as unlawful and voluntary initiatives have focused on distributing surpluses. Nevertheless, supply chain waste remains easily hidden and supermarkets still yield enormous market power over their suppliers. Fortunately, few other sectors face supply chain waste of a similar magnitude, not least because shelf life is much less of an issue for products other than food.

Source: Stuart (2009).

### 9.4.5 Reverse logistics

In a circular economy, products should not only get to the consumer but also return to retailers or suppliers to enable repair, remanufacturing and other Rs. Supply chains that go in the opposite direction are often referred to as reverse logistics. Reverse logistics have existed for a long time to enable return of defective or unsuitable products, such as an ill-fitting pair of shoes or an appliance with a manufacturing fault. Reverse logistics have greatly expanded with the rise of online retail because consumers cannot try out the product in-store.

In a circular economy, reverse logistics are relevant to every single item that is bought or sold because, at some point, it will need to go to the right place for maintenance and repair, reuse, or refurbishing and remanufacturing. Even for recycling, which currently relies on general waste collection, reverse logistics may be important; recycling efficiency could be improved by taking items directly from the consumer to specialised facilities that can disassemble the product and sort the materials. Reverse logistics benefit from the following:

- *Products that are worth it.* Reverse logistics are costly and should be balanced against product value and the cost of repair, recycling or other operations to maintain value. As discussed before, circular strategies are interlinked; reverse logistics depends on good product design to ensure the operation makes economic sense.
- *Door-to-door logistics.* Products must move from individual consumers to specific businesses. The initial step may be the most challenging: how to collect products when they are held by millions of consumers. Here, business models matter. For example, a retailer could reward consumers for returning valuable products.
- *Low-impact transport.* Reverse logistics could double transport emissions because they add a return journey. Low-impact transport is key to ensuring a positive balance of costs and benefits. Keeping it local can reduce transport distances; combining forward and reverse logistics can ensure efficient use of transport capacity.
- *Material and product tracking.* A recovery facility needs to receive a product along with information about its composition and instructions for disassembly. This is possible when product information is widely shared, and products are assigned unique identifiers that can be read and tracked by reverse logistics operators.

Reverse logistics depends on product design and business models. Below are three examples of reverse logistics. How do product design and business models enable these examples of reverse logistics? What further improvements could be made?

- Logistics company I:CO has set up clothing and shoes collection at retail stores including H&M, conveniently allowing customers to return old products when buying new. The collected materials are transported to sorting facilities, where as much as possible is routed for reuse. Most of the items are sold in second-hand markets, turned into other products such as wipes or recycled into new fabrics.
- Furniture manufacturer Ahrend offers products that are leased instead of bought and returned to the company when the contract ends. The furniture is modular; faulty items can be fixed by repairing or replacing only the defective components. Each item is identified by means of a QR code, which allows the company to track stocks and flows of materials.
- The Dutch cities of Rotterdam and The Hague experimented with the collection of small electrical waste (up to 10 kg) by mail delivery couriers. The collection effort required no additional transport other than a trip to a sorting centre because couriers picked up the waste as part of their mail delivery rounds.
- TerraCycle recycles consumer waste that is normally incinerated or landfilled. For example, consumers fill a box for ‘athletic balls’, such as basket balls and tennis balls, and send it back to the company, where each item is taken apart and prepared for reprocessing. The company also works with major brands to help them collect and recycle specific wastes, such as coffee pads.
- Loop, which was started by TerraCycle, offers the delivery of consumer products in reusable packaging, whether ice cream, laundry detergent or fruit juice. The company works with major brands to offer their products in dedicated reusable packaging. Consumers pay a deposit for the packaging, which is returned when the packaging is picked up after use, which may coincide with the next delivery.

Each of the above examples involves businesses that close a logistical gap to make sure products are brought to the right place at the right time. However, if the generation and use of waste were to occur side-by-side, much of the logistics would not be necessary. This is an important factor in the success of industrial symbiosis, which is discussed in the [next section](#).

#### 9.4.6 Industrial symbiosis

Industrial symbiosis describes the exchange of waste as a resource between industries that are traditionally separate. Often, the industries engaging in symbiosis are colocated, enabling exchange without long-distance transport, which is important for bulk, low-value waste streams, and hot steam or water. Symbiosis

is expected to reduce environmental impacts and increase the competitiveness of businesses by avoiding waste. A collection of colocated companies engaging in industrial symbiosis is often called an eco-industrial park.

The oldest and most famous example of industrial symbiosis is the Kalundborg Eco-Industrial Park in Denmark. Here, businesses have exchanged energy, water and materials for decades – well before the concept even had a name. Figure 9.6 shows a map of the exchanges at Kalundborg. Each business is connected with multiple others through the exchange of energy, water and materials. For example, the Novo Nordisk plant generates ethanol waste that is used for energy generation by the Kalundborg utility. At the same time, gypsum from flue gas cleaning at the power plant is used by Gyproc to make plasterboard.

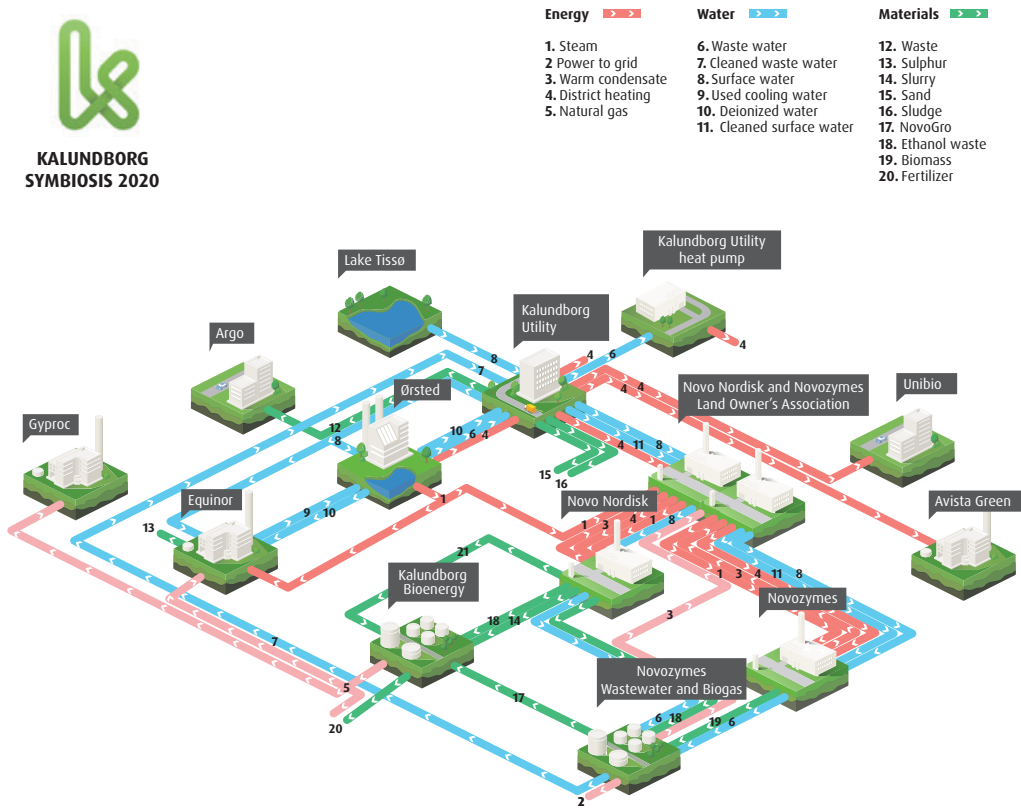

**Figure 9.6 Exchanges of energy, water and materials in the Kalundborg Eco-Industrial Park.** Image: Symbiosis Kalundborg.

The starting point for industrial symbiosis is a good match between supply and demand, which depends on the types of companies and their processes. Besides compatibility, the following factors play an important role:

- *Distance.* The closer businesses are, the more likely the economic and technical feasibility of an exchange. For example, transporting steam requires expensive infrastructure and the further the steam travels, the more it cools down. For bulky, low-value products like sludge and ash, long-distance transport is rarely economically feasible.
- *Trust.* The exchange of waste as a resource requires a joint investment in equipment and creates a long-term dependency between supplier and user. This is feasible only when business owners trust each other sufficiently to engage in complex, long-term contractual arrangements. At Kalundborg, trust emerged partly because business owners are part of the same association and meet regularly.

Industrial symbiosis may be self-organised or managed. At Kalundborg, the first exchanges occurred in the 1970s and the symbiosis remained self-organised for a long time. Only by the late 1980s had Kalundborg drawn wider attention; it became a subject of academic research in the 1990s. In 1996, a local government agency became the manager for new exchanges, transforming the symbiosis from self-organised into facilitated. Today, the facilitator not only promotes symbiosis in Kalundborg but shares industrial symbiosis knowledge and best practices worldwide.

Symbiosis may also be pursued by planning and building, from scratch, eco-industrial parks that feature symbiotic exchanges. This top-down approach has been popular in China and was enabled by the fast expansion of Chinese industry. The top-down approach relies to a great extent on standardisation and certification. Though every context is different, experience suggests that symbioses tend to be most successful when they start off with some degree of self-organisation, based on a coincidental alignment of interests. Once the first exchanges are in place, facilitation can help expand the symbiosis network.

### EXERCISE 9.3 SYMBIOSIS ON CAMPUS

As the term indicates, industrial symbiosis is about industry, but its principles can be applied at different levels and scales. In this exercise, you will identify opportunities for industrial symbiosis at a university campus.

- Make a list of the different activities taking place at your university. A straightforward approach is to list the types of spaces: lecture halls, canteens, laboratories, workshops, halls of residence, sports facilities and so on.
- When you have identified at least ten activities, list the main inputs they require (e.g., electricity, water, chemicals, food) and the main wastes they generate (e.g., packaging, wastewater, medical waste).
- Identify which activities could exchange waste as a resource. If you cannot think of any exchanges, try to identify which activities might be added to the campus that could make good use of the available waste.
- For the exchanges you listed, consider how distance, trust and compatibility play a role in the success or failure of the potential symbiosis. What speaks in favour of the exchanges? What might be the challenges?
- Finally, consider how the symbiotic exchanges may be achieved in practice. If you were assigned the role of facilitator, how would you go about enabling the symbiosis? What would be your first steps to create symbiosis at your university?

If possible, compare your results with others. What are the most promising symbioses you can think of as a group? What are the most promising steps for putting them into practice?

## 9.5 ACHIEVING CIRCULARITY

### 9.5.1 Measuring progress

The measurement of circularity is essential to establish a baseline and to assess progress towards a circular economy. [Section 2.3.1](#) discussed the DPSIR framework for measuring the impacts of human activity. The framework describes drivers (e.g., virgin material processing), pressures (e.g., energy use and carbon emissions), states (e.g., atmospheric concentrations of CO<sub>2</sub>), impacts (e.g., sea level rise) and responses (e.g., recycling to displace virgin materials). In the DPSIR framework, efforts to establish a circular economy can be interpreted as a response to impacts driven by linear modes of production and consumption.



Circular-economy indicators are often based on a material balance of the system of interest, which could be, for example, a supply chain, a city, a country or the global economy. The indicators tend to focus on drivers and responses related to material use. Two examples of drivers and responses were already introduced in the previous paragraph: virgin material extraction and recycling. Additional indicators may focus on the other elements of the DPSIR framework; however, since these are rarely material or product flows, they tend to receive less attention in the measurement of circular economy.

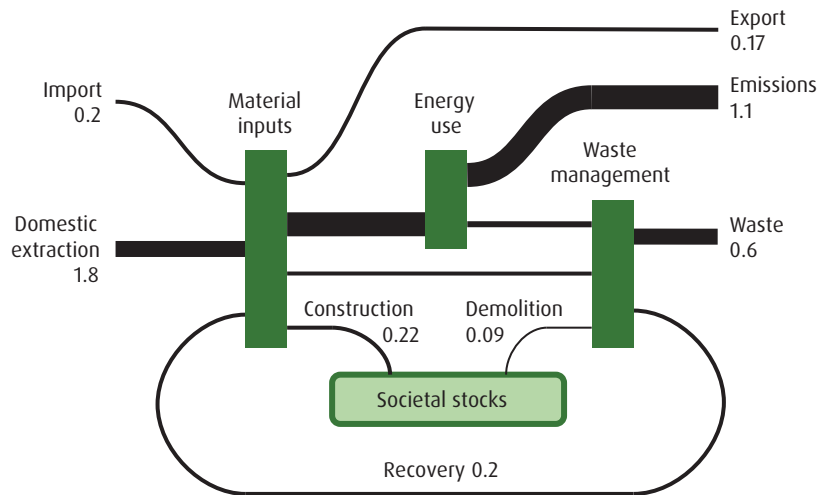

**Figure 9.7 Biomass in the EU in 2014, in Gt.** Adapted from Mayer et al. (2019).

Figure 9.7 shows the material flows associated with the use of biomass in the European Union (a subset of the flows shown previously in Figure 1.5). The material system in Figure 9.7 can be summarised using material flow indicators that focus on system inputs, system outputs, the efficiency of material use and the prevalence of loops.

- *Material inputs.* The required inputs of virgin materials are a useful proxy for the environmental, economic and social impacts of material use. A possible metric based on the figure is the total input of biomass, which amounts to 2.0 Gt.
- *Waste outputs.* Equally insightful can be the amount of material that leaves a system as solid waste or air emissions, or that becomes irreversibly dispersed (such as corroded metal). In the example, the total domestic processed output (DPO) is 1.7 Gt.

- *Efficiency.* The measurement of efficiency indicates the extent to which inputs are converted into useful outputs. From [Figure 9.7](#), it can be inferred that, for example, about a tenth of the inputs are converted into long-term stocks.
- *Loops.* The extent to which materials are looped back into the economy is perhaps the most obvious indicator of circularity. In [Figure 9.7](#), 0.2 Gt of biomass is recovered, constituting a fourth of the solid waste, and displacing about a tenth of the system inputs.

The above material flow indicators only capture drivers and responses. To capture pressures, states or impacts, traditional metrics are needed, for example, regarding energy use and emissions. Besides, additional useful indicators could measure economic and social outcomes, such as income, employment and wage inequality. However, it is the material flow indicators that are most closely associated with the concept of circularity. The other metrics have been used for a long time already and are not exclusive to circular-economy thinking.

The material flow metrics discussed above were exemplified for biomass at the macro-scale (the EU). The metrics can also be used at the meso- and micro-scale. In addition, it can be insightful to measure a circular economy in terms of the prevalence of the circular strategies (product design, business models, supply chains, reverse logistics or industrial symbiosis), for example, the number of industrial parks that engage in symbiosis. In [Exercise 9.4](#), you will explore the many possibilities for measuring the circular economy at the micro- and meso-level.

#### EXERCISE 9.4 MESO AND MICRO CIRCULAR ECONOMY INDICATORS

Pick one of the circular strategies from the [previous section](#): product design, business models, supply chains, reverse logistics or industrial symbiosis. For the chosen strategy, identify the means and the ends. What is the objective (desired outcome) of the strategy? Through which activities is the objective pursued? For example, industrial symbiosis aims to reduce material and energy use by exchanging waste as a resource.

Consider how you might measure these objectives and activities. For the example of industrial symbiosis, you would have to answer the following questions. How, where and when would you measure material and energy use? How, when and where would you measure the exchange of waste as a resource?



Evaluate the indicators you picked. Good indicators are found in the acronym RACER: they reflect relevant objectives, are acceptable to all stakeholders, provide credible information, rely on easy-to-collect data and are robust, which means they are sensitive to relevant developments but resistant to manipulation. Are your indicators RACER?

### 9.5.2 System inertia

Moving towards a circular economy requires a transformation of the linear economy, which cannot happen overnight. Modern economies are interlocking arrangements of social and technical factors that function like the cogs of a complex machine. This complex machine may be called a socio-technical system. A linear economy and a circular economy are almost entirely different socio-technical systems that consist of altogether different components. This section discusses why socio-technical systems are resistant to change; [Section 9.5.3](#) explains how change may happen nevertheless; [Section 9.5.4](#) reflects on how societies can accelerate change.

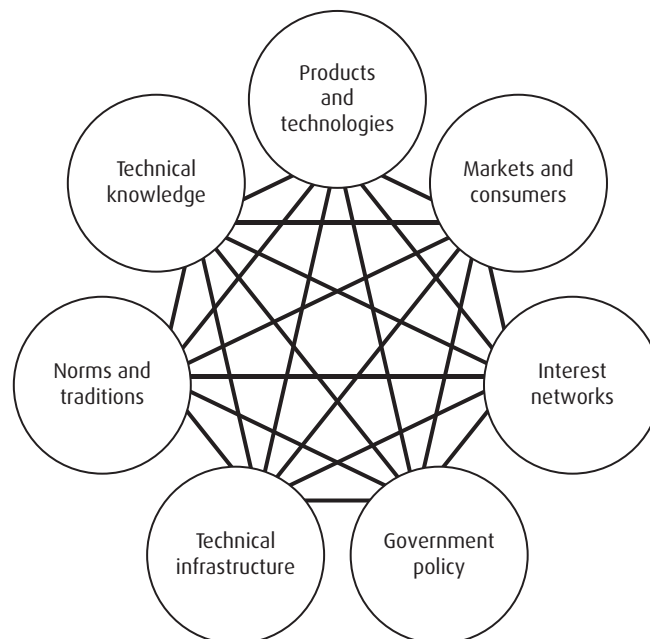

**Figure 9.8 The components and linkages of a socio-technical system.** Image: Authors' own.

Figure 9.8 offers an abstract representation of the elements of a socio-technical system. The lines show the linkages between the elements. To understand the elements better, we compare two socio-technical regimes. By regime, we mean a dominant layout of the socio-technical system. Table 9.1 shows a comparison between two regimes for waste management: a linear system that relies on waste-to-landfill and a more circular system in which recycling dominates. For the sake of simplicity, we leave out other waste management options (e.g., incineration) and assume that one technology dominates the entire system.

**Table 9.1 Two socio-technical regimes compared.**

Socio-technical elements	Socio-technical regime	
	Waste-to-landfill	Recycling
Products and technologies	Nonrecyclable products of any material, in any combination; product performance is not compromised by recyclability	Products of recyclable materials, fewer multi-material designs; performance potentially compromised by recyclability
Markets and consumers	Abundant offer of cheap disposable items that offer convenience and do not require source-separation; no secondary commodity markets	More costly products of sometimes lower material quality; thriving national and global secondary commodity markets
Interest networks	Alignment of interests between virgin material providers, manufacturers and retailers of disposables, and landfill owners	Alignment of interests between waste collectors, recyclers and reprocessors, and manufacturers and retailers of recyclable products
Government policy	Waste policy ensures comprehensive local waste collection, safe disposal with minimum local impacts and limitations on transboundary transport	Waste policy ensures separate collection and coordination of trade in recyclables; product policy ensures recyclability, including for international supply chains
Technical infrastructure	Mixed waste collection systems including bins, trucks, transfer stations and local landfills; few product or commodity standards required	Source-separate collection with a variety of bins, trucks, sorting and transfer stations, national and global trade networks, globally distributed reprocessing capacity and a range of product and commodity standards
Norms and traditions	Waste management is a public service that takes a nuisance – solid waste – away from consumers and businesses; once disposed of, waste is no longer seen as a problem	Waste management is an intermediary between waste generation and reprocessing, driven partly by the market for secondary materials; recycling is an environmental behaviour and an economic opportunity
Technical and scientific knowledge	Expertise in local logistics, waste treatment, as well as landfill design, construction and operation	Expertise in local and global logistics, product design, sorting and treatment technology, and material reprocessing

Table 9.1 shows that each element of the waste-to-landfill regime is substantially different from the corresponding element of the recycling regime. This implies that a shift from a landfill regime towards a recycling regime requires all elements to change. Moreover, these changes should occur more or less simultaneously because the elements are interlinked. For example, it would make little sense to introduce recyclable products before creating a collection infrastructure with source-separation of recyclables, or before consumers have become aware of the benefits of recycling and have a willingness to engage in sorting.

### 9.5.3 Regime change

Despite the inertia of socio-technical systems, change does happen. To an observer unfamiliar with systems theory, change in socio-technical systems may be frustratingly slow or surprisingly rapid. When looking more closely, however, change happens through a combination of gradual and more rapid changes in the various elements of a socio-technical system. The first changes often occur on the fringes of a system and are noticed only by a select group of people. Below are examples of early change for three socio-technical systems: electricity supply, personal transport and food packaging.

- The first solar panels were not developed by a large utility to generate renewable electricity for the grid, but to power space missions and satellites. Cheap solar panels owe their development to the peculiarities of the aerospace market; in space, solar radiation is the only source of energy and the initially high costs of harnessing it were no issue for the space agencies, which spent vast amounts on space missions.
- The first major producer of electric cars in the United States was not one of the large carmakers, but Tesla, a newcomer to the car industry. Tesla was not held back by previous investment in expertise and equipment to build cars with internal-combustion engines. The company sold its first models to a discerning and deep-pocketed group of customers, which created the cashflow and brand name required to develop other models.
- The first reusable food packaging programme for big brands in the United States was not developed by a major food company, nor by a major packaging company, but by Loop, a spin-off from the social enterprise TerraCycle (Section 9.4.5). The programme required a complete rethink of traditional product marketing and logistics. Loop's first sales have been to environmentally conscious and adventurous consumers who are willing to pay a bit more.

The above examples highlight two common aspects of early regime change: it tends to get started by outsiders and the new technologies initially serve small markets that appreciate certain performance aspects, even if the overall performance is compromised (including its price). A market in which new technologies and practices can develop is called a niche. Niches are populated by new companies and customers with demands that are different from the mainstream. In the context of waste management, such customers are often environmentally conscious.

In a niche, new products and services can develop outside of the pressures of the regime. The protection of the niche is important, because new technologies, even if conceptually superior, have limited performance, or cannot yet be tailored to consumer preferences. For example, reusable food packaging may be superior to traditional packaging as an idea; however, at least initially, stores offer it only for dry foods such as rice and cereals. As a result, it may appear much less attractive than the traditional packaging options.

Once a technology has matured in a niche, it may become a serious contender to technologies in the regime. This is a difficult process, often actively resisted by people with strong (financial) interest in the status quo. Many people may not actively resist change, but simply carry on as before, failing to notice the potential of the new technology. As said before, for the regime to change, it requires adjustments to all the elements listed in [Table 9.1](#), which implies an effort of people in many different roles: entrepreneurs, regulators, consumers, scientists and citizens.

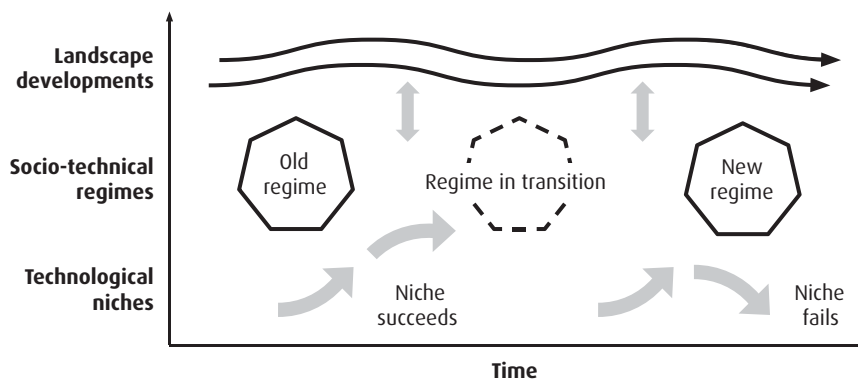

**Figure 9.9 Socio-technical regime change.** Adapted from Geels (2002).

Figure 9.9 provides an abstract depiction of regime change (the regime heptagon resembles Figure 9.8). The old regime may transition to a new regime when technological niches deliver a mature technology that can replace the incumbent technology. Regime change may be accelerated under the influence of larger trends, such as rising concerns of climate change, which may be called ‘landscape’ developments. The period of transition is a form of crisis in which people and organisations have to adapt. A new, stable regime emerges after the period of profound change.

For waste management, relevant landscape developments include climate change, economic growth, globalisation, material scarcity and more. The interaction between regime and landscape is mutual; for example, landfill contributes to climate change and concerns over climate change lead people to question landfill practices. At the same time, new technologies that can respond to the pressures develop in niches, such as recycling technology for certain materials. Taken together, recycling practices may break through into the regime and displace landfill practices.

#### 9.5.4 Transition management

Transition management is the deliberate effort to achieve a regime shift. The position of transition manager naturally lies with governments because they have the authority to stimulate system-wide changes. However, everyone can use the principles of transition management to contribute to change, whether in a coordinating role or not. For example, activists may rethink their approaches to demanding regulatory changes in the context of transition management, and entrepreneurs may strategically exploit niche developments.

An important part of transition management is to aid in the success of niches by stimulating their growth and supporting the entry of the niche technology into the regime. For example, the introduction of electric cars was accelerated through subsidies that reduced the purchase price, which expanded the potential pool of buyers, public investment and standardisation of infrastructure, and public and private commitments to phase out the internal-combustion engine. Together, the interventions helped the electric car leave the niche and enter the regime.

Transition management is not about directing change from the top down; it is about being sensitive to the character of change, including the following factors, which are relevant to both niche developments and regime change.

- Transitions are long-term, and so is the transition to a circular economy. Transitions are motivated by a vision of a long-term future that is very different from the present. To pursue this future, specific objectives are useful, but they should remain open to a variety of pathways for change, since the best one cannot be known in advance. A circular economy is an example of a vision that guides a transition; it is probably clear enough but not overly specific.
- Networks that bring together stakeholders offer opportunities to learn, coordinate and coevolve. Generally speaking, a tight social network helps people move in the same direction. Many national and international circular-economy initiatives are essentially efforts to build a network of likeminded people. The best-known effort to build a network of stakeholders in the circular economy is probably the UK-based Ellen MacArthur Foundation.
- Transitions affect many different domains (e.g., industrial sectors), levels (e.g., local, national, global) and people (e.g., business leaders, policymakers, activists, politicians, workers). A successful transition should provide options for people to adapt, which often takes time. For the transition from landfill to recycling, adaptation includes retraining waste workers, increasing consumer acceptance of source-separation and developing local government expertise.
- The old technology may not need to be phased out entirely and may need investment still. For example, landfill still has a role to play in a recycling regime, just a different and smaller one. Moreover, while a shift to recycling brings many benefits, so does the improvement of landfill technology, for example, by installing landfill gas recovery on existent landfills ([Section 8.5.5](#)). It would be a missed opportunity to focus solely on developing the new technology.
- Learning should be accommodated throughout the transition process, to continuously evaluate and adjust the transition strategies. Many of the efforts to promote a circular economy are about providing (government or private) support for trying out new business models and products. The ones that work may be pursued further. The aforementioned networks play a very important role in disseminating new ideas and knowledge.
- To be able to act on what is learned, transition options should be kept open. Halfway through a transition, it may become clear that better alternatives exist. The shift from landfill to recycling exemplifies this; in the process of pursuing the recycling ideal, societies have realised that reuse and prevention may be more important, as emphasised by the circular economy concept, and even essential to achieve sustainability outcomes.



As discussed above, a circular economy is not just about recycling; it prioritises prevention and reuse. In the next exercise, you will think about the role of transition management in achieving the widespread adoption of reuse, given a status quo in which recycling prevails.

### EXERCISE 9.5 THE TRANSITION FROM RECYCLING TO REUSE

Regime change has taken many countries from an overreliance on landfill to a system focused on recycling. However, there is a long way to go towards a system in which reuse dominates over recycling. In this exercise, you will think as a transition manager about this challenge, with a focus on packaging.

Examples of reusable packaging abound, but most of them qualify as niche activities, such as brand-specific reusable containers, bulk offers of dry foods (e.g., rice, beans) in supermarkets and discounts at coffee shops for bringing a reusable cup. At the same time, corporate efforts at sustainability often still emphasise recycling.

First, select a reuse initiative you are personally familiar with, or pick one described earlier in this exercise or elsewhere in this chapter. For example, [Section 9.4.5](#) discussed the reusable packaging approach from Loop.

Second, consider what actions could further develop the niche. Consider the role of expectations (e.g., pledges, roadmaps, targets), networks (e.g., research collaborations, lobby groups, stakeholder meetings) and learning (e.g., pilot studies, financial support).

Third, consider how the niche may ultimately displace the regime. How might the seven elements of the socio-technical regime evolve? What could be the role of the relevant landscape pressures, such as concerns over plastic litter and economic growth?

Finally, think about the five considerations introduced in the present section. How do they apply to the case you are studying? Based on this, expand and improve the suggestions you already made. For example, what objectives can you specify?

#### 9.5.5 Beyond circularity

[Chapter 1](#) started with a discussion of resource use and waste generation by looking at the IPAT equation, which shows the relationship between impacts (I), population (P), affluence (A) and technology (T). The equation showed that impacts – whether a material footprint, air emissions or biodiversity loss – should be expected to increase with the number of people and how rich these people

are. Technology could either increase or decrease impacts, depending on whether it is more or less efficient than past technologies.

The circular economy is largely a strategy for reducing impacts through technological change. In this context, we understand technology as a broad concept that includes product design, business models and other practices. The circular economy is not concerned with questions of population growth, and is often promoted as a means to increase affluence. This brings us back to the essential trade-offs presented by the IPAT equation: is it possible to increase affluence yet reduce impacts through circularity? Can the gains of prevention and reuse offset the impacts of growing income?

In the short term, there are clear opportunities for increasing affluence while bringing down impacts because some technologies are simply much more efficient than others (e.g., public transport versus personal transport). However, in the long term, the steady annual growth of the economy can lead to vast increases in the level of affluence. As pointed out in [Chapter 1](#), the economy has grown about 20-fold over a century. If the world economy continues to grow at this rate, the annual economic output should be expected to multiply by 20 again by the year 2100.

[Section 9.3.4](#) identified a range of inherent constraints on circularity. So, while the growth in affluence is potentially unlimited, a circular economy clearly does have limits. Population being equal, the IPAT equation suggests that even a circular economy is not sufficient to keep impacts in check. There is, of course, massive uncertainty regarding the long-term future; however, conceptually speaking, it is very difficult to reconcile infinite growth with the need to protect the environment from the impacts of anthropogenic activity.

Global projections show that population growth may level off this century, approximately stabilising the total population by 2100. Such a stabilisation would take population growth out of the IPAT equation, but still leaves humanity with the difficult relationship between growing affluence and more efficient technology. Do you believe technology can overcome our challenges? What should be our priorities for the next decades? Should we already anticipate what happens after? Most importantly, what role do you foresee for waste management and a circular economy?

## 9.6 SUMMARY

A circular economy aims to achieve sustainability outcomes through the efficient and circular use of materials. In a circular economy, the harvest of renewable materials occurs no faster than their regrowth, depletable materials

are substituted with renewables over time and pollution stays within the limits of the environment. Circularity is expected to benefit businesses through cost savings on raw materials, reduced exposure to price volatility and supply challenges for rare materials, and marketing benefits from greener products. Ideally, a circular economy also brings wider social benefits, such as greater wellbeing, health and equality.

In a circular economy, materials are cycled as biological nutrients (e.g., composting) or technical nutrients (e.g., recycling). Circularity is aligned with the waste hierarchy but presents a wider range of options, including, for example, repair and remanufacturing. The aim of the various loops is to maintain products and materials at their highest value. Perfect circularity, in which all materials re-enter the economy, is only a theoretical ideal because of the energy cost of circulation, the lack of availability of materials locked in-use, the irreversible deterioration of materials, growing demand and changing consumer preferences.

Circular strategies are the activities that can make an economy circular. At the micro-level, product design and business model innovation often go hand-in-hand, such as sturdy products that are suitable for sharing through a leasing business model. At the meso-level, improvements focus on reducing supply chain waste, reverse logistics for the return of materials and products to earlier stages of the lifecycle, and industrial symbiosis, which is the exchange of waste as a resource between industries, often over short distances. At the macro-level, national or global initiatives, such as government policies or industrial networks, can support micro and meso activity.

Finally, to achieve a circular economy, it is important to set targets and measure progress based on material inputs, waste outputs, the extent of loop-closing and resource efficiency. The shift from a linear to a circular economy requires a socio-technical transition, in which many technical and nontechnical factors change simultaneously. The transition may be promoted through transition management, which is a long-term, whole-systems approach to stimulating change, which includes the displacement of the linear economy by strategically supporting the development and implementation of circular technologies and practices.

## 9.7 REVIEW

1. Illustrate the three premises of a circular economy with examples related to plastics.
2. List the main principles for achieving environmental sustainability.

- 3.** Explain how the 10 Rs can maintain materials and products at a high value.
- 4.** Explain four ways to distinguish or categorise loops in a circular economy.
- 5.** Describe how to apply the seven aspects of circular design to an office chair.
- 6.** Give three examples of how business models depend on product design.
- 7.** Explain the differences between reverse logistics and industrial symbiosis.
- 8.** Suggest metrics for measuring circularity of the capital city of your country.
- 9.** Explain how niche, regime and landscape interact during a transition.
- 10.** Explain your views on the implications of the IPAT equation for circularity.

## FURTHER READING

This section lists resources for further study. Almost all of them are publicly accessible and the recommended textbooks are typically available from university libraries.

### Waste and materials data

- *Waste flow data.* Data on waste generation and treatment is available for EU countries from Eurostat ([ec.europa.eu/eurostat](http://ec.europa.eu/eurostat); tables ENV\_WASGEN and ENV\_WASTRT), for the United States from the US EPA, for China from the National Bureau of Statistics of China and other government agencies. Further international data is provided by the OECD ([stats.oecd.org](http://stats.oecd.org)). For countries that are not in the EU or OECD, some waste data is available from the United Nations ([unstats.un.org](http://unstats.un.org)).
- *Material flow data.* Economy-wide material flow data is available from Eurostat ([ec.europa.eu/eurostat](http://ec.europa.eu/eurostat); table ENV\_AC\_MFA). The International Resource Panel (IRP) hosts a global database with economy-wide material flow accounts. Related datasets and visualisations are available from [materialflows.net](http://materialflows.net) and [resourcewatch.org](http://resourcewatch.org). The UN Food and Agriculture Organization (FAO) has data on biotic material flows ([fao.org/faostat](http://fao.org/faostat)).
- *Material flow analyses.* A wealth of material flow data is available from MFA studies published in academic journals, including: the *Journal of Industrial Ecology*; *Resources, Conservation and Recycling*; and the *Journal of Cleaner Production*. Most of these journals are not open-access, but individual articles may be freely available. Some newer journals, such as *Sustainability*, are open-access and also publish many MFAs.
- *Recycling statistics.* Many national and international agencies provide recycling statistics, including Eurostat ([ec.europa.eu/eurostat](http://ec.europa.eu/eurostat)) and the OECD ([stats.oecd.org](http://stats.oecd.org)). The Bureau of International Recycling (BIR), the global federation of the recycling industry, brings together global statistics and analyses for many recyclables ([bir.org](http://bir.org)). National and international industry associations often supply recycling data for specific materials (e.g., paper) or products (e.g., tyres).

### Assessment methods

- *Material flow analysis.* The classic work on MFA is the *Handbook of Material Flow Analysis* by Brunner and Rechberger (2nd edition, 2016). A helpful

tool for conducting MFA, which includes good guidance documentation, is STAN ([stan2web.net](http://stan2web.net)). For economy-wide MFA, standardised methods are published by the EU statistics agency Eurostat, including the 2018 edition titled *Handbook of economy-wide material flow accounts*.

- *Lifecycle assessment*. The ISO standards 14040 and 14044 2006 provide broad guidelines for LCA. An excellent open-access book on LCA is *Life Cycle Assessment: Quantitative approaches for decisions that matter* (Matthews, Hendrickson and Matthews 2014). The Life Cycle Initiative ([lifecycleinitiative.org](http://lifecycleinitiative.org)), hosted by the UN, offers many useful resources on LCA, including reports and an online course.
- *Cost-benefit analysis*. When governments require CBA to be conducted for policy evaluation, they typically provide guidance on the methods. In the UK, a national government publication called *The Green Book* provides such guidance for policy evaluation, and it is frequently updated. Similar guidance may be provided by other governments.
- *Environmentally extended input-output analysis*. An introduction to the principles and applications of EEIO is provided by Kitzes (2013).
- *Environmental impact assessment*. The European Commission provides extensive guidance for EIA, in a series called *Environmental Impact Assessment of Projects*. The individual reports are titled *Guidance on Screening*, *Guidance on Scoping* and *Guidance on the Preparation of the Environmental Impact Assessment Report*.
- *Social impact assessment*. The International Association for Impact Assessment (IAIA) has published guidance for conducting SIA (Vanclay et al. 2015).
- *Social lifecycle assessment*. The aforementioned Life Cycle Initiative ([lifecycleinitiative.org](http://lifecycleinitiative.org)) published a report on SLCA titled *Guidelines for Social Life Cycle Assessment of Products and Organizations 2020* (UNEP 2020).

## Technologies and practices

- *Waste legislation*. Waste legislation texts and guidance can be found on the internet, including for the WFD in the EU (search '2008/98/EC'), the Resources Conservation and Recovery Act in the United States (search 'EPA RCRA'), the Circular Economy Law in China (search 'China Circular Economy Promotion Law') and the Basel Convention (search 'Basel Convention text').

- *Best available techniques.* The best available techniques reference documents (BREFs) by the European Commission are available on the internet ([eippcb.jrc.ec.europa.eu/reference](http://eippcb.jrc.ec.europa.eu/reference)) and cover a range of industries, sectors and activities. Each BREF deals with waste and other environmental impacts, with separate BREFs for waste incineration and treatment.
- *Various subjects.* The website of the US EPA has easily accessible information about a range of topics, including waste classification, regulation, treatment and recovery. While some of the information is specific to the United States, especially classification and regulation, much of the technological information applies across national contexts.
- *Wastewater treatment.* Wastewater is not in the scope of the present book, but the topic is closely related. A great resource on wastewater management is the textbook *Wastewater Engineering: Treatment and resource recovery* by Metcalf & Eddy, Inc. et al. (2014), which is available from most university libraries.

## Circular economy

- *Policies for the circular economy.* The report *Resource Efficiency and the Circular Economy: Concepts, economic benefits, barriers, and policies* (Van Ewijk 2018) describes the foundations of circular economy and their application to public policy.
- *Industrial ecology.* The field of industrial ecology provides much of the scientific foundation that underpins the circular economy. The White Paper *Ten Insights from Industrial Ecology for the Circular Economy* (Van Ewijk et al. 2023) summarises these foundations.
- *Materials management.* The book *Sustainable Materials: With both eyes open* (Allwood et al. 2012) provides an excellent analysis of strategies for reducing the use of steel, aluminium, cement, plastic and paper. It is freely available in digital format ([withbotheyesopen.com](http://withbotheyesopen.com)).
- *Ideas that inspired the circular economy.* The concepts listed in [Box 9.1](#) have been described in books, videos and other materials. Search online for the terms ‘cradle-to-cradle’, ‘biomimicry’, ‘performance economy’, ‘blue economy’, ‘natural capitalism’ and ‘regenerative design’ to find out more about these antecedents of the circular economy.

## REFERENCES

All URLs were last accessed 17 July 2023.

- Allwood, Julian M., Jonathan M. Cullen, Mark A. Carruth, Daniel R. Cooper, Martin McBrien, Rachel L. Milford, Muiris C. Moynihan and Alexandra C. H. Patel.** 2012. *Sustainable Materials: With both eyes open*. Cambridge: UIT Cambridge Limited.
- Anastas, Paul T. and Julie B. Zimmerman.** 2003. 'Peer reviewed: Design through the 12 principles of green engineering'. *Environmental Science & Technology* 37 (5): 94A–101A. <https://doi.org/10.1021/es032373g>.
- Arafat, Hassan A., Kenan Jijakli and Amimul Ahsan.** 2015. 'Environmental performance and energy recovery potential of five processes for municipal solid waste treatment'. *Journal of Cleaner Production* 105 (October): 233–240. <https://doi.org/10.1016/j.jclepro.2013.11.071>.
- Babbitt, Callie W., Hema Madaka, Shahana Althaf, Barbara Kasulaitis and Erinn G. Ryen.** 2020. 'Disassembly-based bill of materials data for consumer electronic products.' *Scientific Data* 7 (1): 251. <https://doi.org/10.1038/s41597-020-0573-9>.
- Beck, Eckardt C.** 1979. 'The love canal tragedy'. *EPA Journal* (January).
- BEIS.** 2022. 'Digest of UK energy statistics (DUKES): Calorific values and density of fuels'. London: Department for Business, Energy & Industrial Strategy. [www.gov.uk/government/statistics/dukes-calorific-values](http://www.gov.uk/government/statistics/dukes-calorific-values).
- Benzaken, Hilla.** 2018. '5 Companies that embrace the concept of a circular economy'. GoodNet, 15 April. [www.goodnet.org/articles/5-companies-that-embrace-concept-circular-economy](http://www.goodnet.org/articles/5-companies-that-embrace-concept-circular-economy).
- Bogush, Anna, Julia A. Stegemann, Ian Wood and Amitava Roy.** 2015. 'Element composition and mineralogical characterisation of air pollution control residue from UK energy-from-waste facilities'. *Waste Management* 36: 119–129. <https://doi.org/10.1016/j.wasman.2014.11.017>.
- Boiral, Olivier, Laurence Guillaumie, Iñaki Heras-Saizarbitoria and Christian Valery Tayo Tene.** 2018. 'Adoption and outcomes of ISO 14001: A systematic review'. *International Journal of Management Reviews* 20 (2): 411–432. <https://doi.org/10.1111/ijmr.12139>.
- Boulding, Kenneth E.** 1966. 'The economics of the coming spaceship earth'. In *Environmental Quality in A Growing Economy*, edited by **Henry Jarrett**, 3–14. Baltimore, MD: Resources for the Future/Johns Hopkins University Press.
- Brunner, Paul H. and Helmut Rechberger.** 2016. *Practical Handbook of Material Flow Analysis*, 2nd edition. Boca Raton, FL: CRC Press.
- Bukhari, Mohammad Abdullatif, Ruth Carrasco-Gallego and Eva Ponce-Cueto.** 2018. 'Developing a national programme for textiles and clothing recovery'.



- Waste Management & Research* 36 (4): 321–331. <https://doi.org/10.1177/0734242X18759190>.
- Calbry-Muzyka, Adelaide, Hossein Madi, Florian Rüsç-Pfund, Marta Gandiglio and Serge Biollaz.** 2022. 'Biogas composition from agricultural sources and organic fraction of municipal solid waste'. *Renewable Energy* 181: 1000–1007. <https://doi.org/10.1016/j.renene.2021.09.100>.
- CEMBUREAU. 2016. 'Activity Report 2016'. Brussels: CEMBUREAU, the European Cement Association. <https://cembureau.eu/library/reports/>.
- CEPI. 2019. 'Key Statistics 2018: European pulp & paper industry'. Brussels: CEPI, the Confederation of European Paper Industries. <https://www.cepi.org/statistics/>.
- Chakraborty, Laura Burger, Asif Qureshi, Carl Vadenbo and Stefanie Hellweg.** 2013. 'Anthropogenic mercury flows in India and impacts of emission controls'. *Environmental Science and Technology* 47 (15): 8105–8113. <https://doi.org/10.1021/es401006k>.
- Chung, Moonkyung and Yun Hee Kim.** 2009. 'Evolution of Sudokwon Landfill: From waste containment to energy generation'. *Proceedings of the Korean Geotechnical Society Conference* (September): 186–193.
- City of Kirkland. 2023. 'Reducing waste'. Washington. [www.kirklandwa.gov/Government/Departments/Public-Works-Department/Solid-Waste-Services/Waste-Reduction](http://www.kirklandwa.gov/Government/Departments/Public-Works-Department/Solid-Waste-Services/Waste-Reduction).
- Clapp, Jennifer and Linda Swanston.** 2009. 'Doing away with plastic shopping bags: International patterns of norm emergence and policy implementation'. *Environmental Politics* 18 (3): 315–332. <https://doi.org/10.1080/09644010902823717>.
- Cooper, Daniel R., Alexandra C. H. Skelton, Muiris C. Moynihan and Julian M. Allwood.** 2014. 'Component level strategies for exploiting the lifespan of steel in products'. *Resources, Conservation and Recycling* 84: 24–34. <https://doi.org/10.1016/j.resconrec.2013.11.014>.
- Cunningham, William P. and Mary Ann Cunningham.** 2004. 'Additional case studies'. *Principles of Environmental Science*, 2nd edition. New York: McGraw Hill Education. [https://higherred.mheducation.com/sites/0072919833/student\\_view0/chapter13/additional\\_case\\_studies.html](https://higherred.mheducation.com/sites/0072919833/student_view0/chapter13/additional_case_studies.html).
- Daehn, Katrin E., André Cabrera Serrenho and Julian M. Allwood.** 2017. 'How will copper contamination constrain future global steel recycling?'. *Environmental Science and Technology* 51 (11): 6599–6606. <https://doi.org/10.1021/acs.est.7b00997>.
- DEFRA. 2018. *Waste Duty of Care Code of Practice November 2018*. London: Department for Environment, Food & Rural Affairs. [https://assets.publishing.service.gov.uk/government/uploads/system/uploads/attachment\\_data/file/506917/waste-duty-care-code-practice-2016.pdf](https://assets.publishing.service.gov.uk/government/uploads/system/uploads/attachment_data/file/506917/waste-duty-care-code-practice-2016.pdf).

- Deltaway. 2018. 'Waste-to-energy: How it works'. August. <https://deltawayenergy.com/2018/08/waste-to-energy-how-it-works/>.
- Dettling, Jon and Manuele Margni.** 2009. 'Comparative environmental life cycle assessment of hand drying systems'. Quantis.
- Ding, Tao and Jianzhuang Xiao.** 2014. 'Estimation of building-related construction and demolition waste in Shanghai'. *Waste Management* 34 (11): 2327–2334. <https://doi.org/10.1016/j.wasman.2014.07.029>.
- Domenech, Teresa, Paul Ekins, Stijn Van Ewijk, Christian Spano Klein, Bertram Kloss, Michal Miedzinski, Milan Petit, Martin Stuchtey and Julia Tomei.** 2019. 'Making materials work for life: Introducing producer ownership'. Project Launch, September. [www.thecirculateinitiative.org/projects/Making-Materials-Work-for-Life-%E2%80%93-Introducing-Producer-Ownership](http://www.thecirculateinitiative.org/projects/Making-Materials-Work-for-Life-%E2%80%93-Introducing-Producer-Ownership).
- EA/DEFRA. 2020. 'Check if you need an environmental permit - gov.uk'. London: Environment Agency; Department for Environment, Food & Rural Affairs. [www.gov.uk/guidance/check-if-you-need-an-environmental-permit](http://www.gov.uk/guidance/check-if-you-need-an-environmental-permit).
- EA/SEPA/NRW. 2021. *Technical Guidance WM3 – Waste Classification: Guidance on the Classification and Assessment of Waste*. Scottish Environment Protection Agency; Environment Agency; Natural Resources Wales. First published May 2015; last updated January 2021. [www.gov.uk/government/publications/waste-classification-technical-guidance](http://www.gov.uk/government/publications/waste-classification-technical-guidance).
- Easterlin, Richard A., Laura Angelescu Mcvey, Malgorzata Switek, Onnicha Sawangfa and Jacqueline Smith Zweig.** 2010. 'The happiness–income paradox revisited'. *PNAS* 107 (52): 22463–22468. <https://doi.org/10.1073/pnas.1015962107>.
- EC. 2007. 'Communication from the Commission to the Council and the European Parliament on the Interpretative Communication on waste and by-products'. Document 52007DC0059. <https://eur-lex.europa.eu/legal-content/EN/TXT/?uri=celex%3A52007DC0059>.
- EC. 2008a. 'Directive 2008/98/EC of the European Parliament and of the Council of 19 November 2008 on waste and repealing certain Directives'. Document 32008L0098. <https://eur-lex.europa.eu/legal-content/EN/TXT/?uri=celex%3A32008L0098>.
- EC. 2008b. 'Regulation (EC) No 1102/2008 of the European Parliament and of the Council of 22 October 2008 on the banning of exports of metallic mercury and certain mercury compounds and mixtures and the safe storage of metallic mercury'. Document 32008R1102. <https://eur-lex.europa.eu/legal-content/EN/TXT/?uri=celex%3A32008R1102>.
- EC. 2011. 'Directive 2011/65/EU of the European Parliament and of the Council of 8 June 2011 on the restriction of the use of certain hazardous substances in electrical and electronic equipment'. Document 32011L0065. <https://eur-lex.europa.eu/legal-content/EN/TXT/?uri=celex%3A32011L0065>.

- EC. 2017. 'Commission implementing decision (EU) 2017/302 of 15 February 2017 establishing best available techniques (BAT) conclusions, under Directive 2010/75/EU of the European Parliament and of the Council, for the intensive rearing of poultry or pigs'. Document 32017D0302. [https://eur-lex.europa.eu/legal-content/EN/TXT/?uri=uriserv%3AOJ.L\\_.2017.043.01.0231.01.ENG](https://eur-lex.europa.eu/legal-content/EN/TXT/?uri=uriserv%3AOJ.L_.2017.043.01.0231.01.ENG).
- EC. 2023. Waste Framework Directive. [https://environment.ec.europa.eu/topics/waste-and-recycling/waste-framework-directive\\_ga](https://environment.ec.europa.eu/topics/waste-and-recycling/waste-framework-directive_ga).
- Eco TLC. 2016. '2016 at a glance: Half-way results from the 2014–2019 Accreditation Agreement'.
- Ehrlich, Paul R. and John P. Holdren.** 1971. 'Impact of population growth'. *Science* 171 (3977): 1212–1217.
- Engelhaupt, Erika.** 2008. 'Happy birthday, Love Canal'. *Environmental Science & Technology* 42 (22): 8179–8186. <https://doi.org/10.1021/es802376z>.
- EPA. 2009. *The Environmental Professional's Guide to Lean & Six Sigma*. Washington, DC: United States Environmental Protection Agency.
- Euronews. 2021. 'Chempark factory explosion in Germany likely caused by chemical reaction'. 31 August. [www.euronews.com/2021/08/31/chempark-factory-explosion-in-germany-likely-caused-by-chemical-reaction](http://www.euronews.com/2021/08/31/chempark-factory-explosion-in-germany-likely-caused-by-chemical-reaction).
- Eurostat. 2019a. 'Generation of waste by waste category, hazardousness and NACE Rev. 2 Activity [env\_wasgen]'. European Environment Agency. [www.eea.europa.eu/data-and-maps/data/external/generation-of-waste-by-waste](http://www.eea.europa.eu/data-and-maps/data/external/generation-of-waste-by-waste).
- Eurostat. 2019b. 'Treatment of waste by waste category, hazardousness and waste management operations [env\_wastrt]'. European Environment Agency. [www.eea.europa.eu/data-and-maps/data/external/treatment-of-waste-tonnes](http://www.eea.europa.eu/data-and-maps/data/external/treatment-of-waste-tonnes).
- Excel Dryer.** n.d. 'Environmental Product Declaration XLERATOR Hand Dryer'. [www.exceldryer.com/hand-dryer-epds/](http://www.exceldryer.com/hand-dryer-epds/).
- FAO. 2019. 'FAOSTAT: Forestry production and trade'. Food and Agriculture Organization of the United Nations. [www.fao.org/faostat/](http://www.fao.org/faostat/).
- Fire Protection Association. 2021. 'Fire safety hazard leads to £50,000 fine for waste firm director'. 13 April. [www.thefpa.co.uk/news/fire-safety-hazard-leads-to-50-000-fine-for-waste-firm-director](http://www.thefpa.co.uk/news/fire-safety-hazard-leads-to-50-000-fine-for-waste-firm-director).
- Gabrielsen, Peder and Peter Bosch.** 2003. 'Environmental indicators: Typology and use in reporting'. *Eea* (August): 1–20.
- Gallego-Schmid, Alejandro, Joan Manuel F. Mendoza and Adisa Azapagic.** 2019. 'Environmental impacts of takeaway food containers'. *Journal of Cleaner Production* 211 (2019): 417–427. <https://doi.org/10.1016/j.jclepro.2018.11.220>.
- Garcés, Diego, Eva Díaz, Herminio Sastre, Salvador Ordóñez and José Manuel González-LaFuente.** 2016. 'Evaluation of the potential of different high calorific waste fractions for the preparation of solid recovered fuels'. *Waste*

- Management* 47 (January): 164–173. <https://doi.org/10.1016/j.wasman.2015.08.029>.
- Geels, Frank W.** 2002. ‘Technological transitions as evolutionary reconfiguration processes: A multi-level perspective and a case-study’. *Research Policy* 31 (8–9): 1257–1274. [https://doi.org/10.1016/S0048-7333\(02\)00062-8](https://doi.org/10.1016/S0048-7333(02)00062-8).
- Geyer, Roland, Jenna R. Jambeck and Kara Lavender Law.** 2017. ‘Production, use, and fate of all plastics ever made’. *Science Advances* 3 (7): 19–24. <https://doi.org/10.1126/sciadv.1700782>.
- GMI. 2011. *Landfill Methane: Reducing Emissions, Advancing Recovery and Use Opportunities*. Washington, DC: Global Methane Initiative. [www.globalmethane.org/documents/landfill\\_fs\\_eng.pdf](http://www.globalmethane.org/documents/landfill_fs_eng.pdf).
- Gough, Ian.** 2017. ‘Recomposing consumption: Defining necessities for sustainable and equitable well-being’. *Philosophical Transactions of the Royal Society A: Mathematical, Physical and Engineering Sciences* 375 (2017): 20160379. <https://doi.org/10.1098/rsta.2016.0379>.
- Gregson, Nicky, Mike Crang, Julie Botticello, Melania Calestani and Anna Krzywoszynska.** 2016. ‘Doing the “dirty work” of the green economy: Resource recovery and migrant labour in the EU’. *European Urban and Regional Studies* 23 (4): 1–15. <https://doi.org/10.1177/0969776414554489>.
- Greinert, Andrzej, Maria Mrówczyńska and Wojciech Szefner.** 2019. ‘The use of waste biomass from the wood industry and municipal sources for energy production’. *Sustainability (Switzerland)* 11 (11): 3083. <https://doi.org/10.3390/su11113083>.
- Guevarra, Leslie.** 2011. ‘What’s the greenest way to dry your hands?’ GreenBiz, 18 November. [www.greenbiz.com/article/whats-greenest-way-dry-your-hands](http://www.greenbiz.com/article/whats-greenest-way-dry-your-hands).
- Guibrunet, Louise.** 2017. ‘The contribution of the informal economy to urban sustainability: Case study of waste management in Tepito, Mexico City’. PhD thesis, University College London.
- Gupta, Garima, Manoj Datta, G. V. Ramana, B. J. Alappat and Shashank Bishnoi.** 2021. ‘Contaminants of concern (CoCs) pivotal in assessing the fate of MSW incineration bottom ash (MIBA): First results from India and analogy between several countries’. *Waste Management* 135 (August): 167–181. <https://doi.org/10.1016/j.wasman.2021.08.036>.
- Han, Albert T., Lucie Laurian and Min Hee Go.** 2020. ‘Transforming incinerators into community amenities? The Seoul experience’. *Journal of Environmental Planning and Management* 63 (8): 1427–1452. <https://doi.org/10.1080/09640568.2019.1670626>.
- Haupt, Melanie, Carl Vadenbo and Stefanie Hellweg.** 2017. ‘Do we have the right performance indicators for the circular economy? Insight into the Swiss waste management system’. *Journal of Industrial Ecology* 21 (3): 615–627. <https://doi.org/10.1111/jiec.12506>.

- Hemidat, Safwat, Motasem Saidan, Salam Al-Zu'bi, Mahmoud Irshidat, Abdallah Nassour and Michael Nelles.** 2019. 'Potential utilization of RDF as an alternative fuel to be used in cement industry in Jordan'. *Sustainability* 11 (20): 5819. <https://doi.org/10.3390/su11205819>.
- Henze, Mogens and Yves Comeau.** 2008. 'Wastewater characterization'. In *Biological Wastewater Treatment: Principles Modelling and Design*, edited by Mogens Henze, Mark C. M. Van Loosdrecht, George Ekama and Damir Brdjanovic, 35–52. London: International Water Association. <https://iwaponline.com/ebooks/book/326/chapter/659723/Wastewater-characterization>.
- Hern, Alex.** 2013. 'Missing: Hard drive containing Bitcoins worth £4m in Newport landfill site'. *The Guardian*, 27 November. [www.theguardian.com/technology/2013/nov/27/hard-drive-bitcoin-landfill-site](http://www.theguardian.com/technology/2013/nov/27/hard-drive-bitcoin-landfill-site).
- Islam, Kamrul and Shinsuke Murakami.** 2021. 'Global-scale impact analysis of mine tailings dam failures: 1915–2020'. *Global Environmental Change* 70 (August): 102361. <https://doi.org/10.1016/j.gloenvcha.2021.102361>.
- ISO.** 2006. ISO 14040:2006: Environmental Management: Life Cycle Assessment – Principles and Framework. International Organization for Standardization. [www.iso.org/standard/37456.html](http://www.iso.org/standard/37456.html).
- Jackson, Tim.** 2009. *Prosperity Without Growth: Economics for a finite planet*. London: Routledge.
- Jambeck, Jenna R., Roland Geyer, Chris Wilcox, Theodore R. Siegler, Miriam Perryman, Anthony Andrady, Ramani Narayan and Kara Lavender Law.** 2015. 'Plastic waste inputs from land into the ocean'. *Science* 347 (6223): 768–771. <https://doi.org/10.1126/science.1260352>.
- Jebb, Andrew T., Louis Tay, Ed Diener and Shigehiro Oishi.** 2018. 'Happiness, income satiation and turning points around the world'. *Nature Human Behaviour* 2 (January): 33–38. <https://doi.org/10.1038/s41562-017-0277-0>.
- Jeffrey, Tara.** 2022. 'Sewage lagoons at centre of odour complaints were sold by Sarnia in 2020'. *The Sarnia Journal*, 14 June. <https://thesarniajournal.ca/sewage-lagoons-at-centre-of-odour-complaints-were-sold-by-sarnia-in-2020/>.
- Jenks, Andrew B. and Kelsey M. Obringer.** 2020. 'The poverty of plastics bans: Environmentalism's win is a loss for disabled people'. *Critical Social Policy* 40 (1): 151–161. <https://doi.org/10.1177/0261018319868362>.
- Jiménez, Luis, Roberto Alzaga and Josep M. Bayona.** 2002. 'Determination of organic contaminants in landfill leachates: A review'. *International Journal of Environmental Analytical Chemistry* 82 (7): 415–430. <https://doi.org/10.1080/0306731021000018116>.
- JRC/IES.** 2010. *International Reference Life Cycle Data System (ILCD) Handbook: General Guide for Life Cycle Assessment – Detailed Guidance*. Brussels: EC Joint Research Centre, Institute for Environment and Sustainability. <https://doi.org/10.2788/38479>.

- Kamanga, Camille, Benjamin Miller, Juliette Spertus and Lisa Douglas.** 2013. *A Study of the Feasibility of Pneumatic Transport of Municipal Solid Waste and Recyclables in Manhattan Using Existing Transportation Infrastructure, Final Report.* New York: University Transportation Research Center; The City College of New York, CUNY.
- Kaza, Silpa, Lisa C. Yao, Perinaz Bhada-Tata and Frank Van Woerden.** 2018. *What a Waste 2.0: A Global Snapshot of Solid Waste Management to 2050.* Washington, DC: World Bank.
- Kebede, Gezahegn, Eyasu Mekonnen and Rejila Manikandan.** 2018. 'Composition and characterization of municipal solid waste in landfill site: In case of Dilla city, Ethiopia'. *Environmental Science: An Indian Journal Research* 14 (1): 1–8.
- Kijo-Kleczkowska, Agnieszka, Katarzyna Środa, Monika Kosowska-Golachowska, Tomasz Musiał and Krzysztof Wolski.** 2016. 'Combustion of pelleted sewage sludge with reference to coal and biomass'. *Fuel* 170 (April): 141–160. <https://doi.org/10.1016/j.fuel.2015.12.026>.
- Kitzes, Justin.** 2013. 'An introduction to environmentally-extended input-output analysis'. *Resources* 2 (4): 489–503. <https://doi.org/10.3390/resources2040489>.
- Kjeldsen, Peter, Morton A. Barlaz, Alix P. Rooker, Anders Baun, Anna Ledin and Thomas H. Christensen.** 2002. 'Present and long-term composition of MSW landfill leachate: A review'. *Critical Reviews in Environmental Science and Technology* 32 (4): 297–336. <https://doi.org/10.1080/10643380290813462>.
- Knoblauch, Doris, Linda Mederake and Ulf Stein.** 2018. 'Developing Countries in the Lead – What Drives the Diffusion of Plastic Bag Policies?' *Sustainability* 10 (6): 1994. <https://doi.org/10.3390/su10061994>.
- Krausmann, Fridolin, Christian Lauk, Willi Haas and Dominik Wiedenhofer.** 2018. 'From resource extraction to outflows of wastes and emissions: The socioeconomic metabolism of the global economy, 1900–2015'. *Global Environmental Change* 52 (July): 131–140. <https://doi.org/10.1016/j.gloenvcha.2018.07.003>.
- Kumar, Ankit.** 2020. 'Four killed in Avonmouth water works explosion'. SHP Online, 3 December. [www.shponline.co.uk/news/avonmouth-warehouse-explosion/](http://www.shponline.co.uk/news/avonmouth-warehouse-explosion/).
- Lakhani, Nina.** 2019. "Racism dictates who gets dumped on": How environmental injustice divides the world'. *The Guardian*, 21 October. [www.theguardian.com/environment/2019/oct/21/what-is-environmental-injustice-and-why-is-the-guardian-covering-it](http://www.theguardian.com/environment/2019/oct/21/what-is-environmental-injustice-and-why-is-the-guardian-covering-it).
- Laner, David, Julia Feketitsch, Helmut Rechberger and Johann Fellner.** 2016. 'A novel approach to characterize data uncertainty in material flow analysis



- and its application to plastics flows in Austria'. *Journal of Industrial Ecology* 20 (5): 1050–1063. <https://doi.org/10.1111/jiec.12326>.
- Laurian, Lucie and Richard Funderburg.** 2014. 'Environmental justice in France? A spatio-temporal analysis of incinerator location'. *Journal of Environmental Planning and Management* 57 (3): 424–446. <https://doi.org/10.1080/09640568.2012.749395>.
- Lebreton, Laurent C. M., Joost van der Zwet, Jan-Willem Damsteeg, Boyan Slat, Anthony Andrady and Julia Reisser.** 2017. 'River plastic emissions to the world's oceans'. *Nature Communications* 8 (1): 15611. <https://doi.org/10.1038/ncomms15611>.
- Leckner, Bo and Fredrik Lind.** 2020. 'Combustion of municipal solid waste in fluidized bed or on grate: A comparison'. *Waste Management* 109 (2020): 94–108. <https://doi.org/10.1016/j.wasman.2020.04.050>.
- Life Magazine.* 1955. 'Throwaway living: Disposable items cut down household chores', August.
- Low, Morris.** 2013. 'Eco-cities in Japan: Past and future'. *Journal of Urban Technology* 20 (1): 7–22. <https://doi.org/10.1080/10630732.2012.735107>.
- Makov, Tamar and David Font Vivanco.** 2018. 'Does the circular economy grow the pie? The case of rebound effects from smartphone reuse'. *Frontiers in Energy Research* 6 (May): 1–11. <https://doi.org/10.3389/fenrg.2018.00039>.
- Marchand, Leonard, Stijn van Ewijk and Julia A. Stegemann.** 2019. 'Metabolism of metals from co-processing of energy-from-waste air pollution control residue in cement kilns'. In *Sustainable Construction Materials and Technologies*, Vol. 2.
- Matthews, H. Scott, Chris Hendrickson and Deanna H. Matthews.** 2014. *Life Cycle Assessment: Quantitative approaches for decisions that matter*. Self-published. [www.lcatextbook.com/](http://www.lcatextbook.com/).
- Mayer, Andreas, Willi Haas, Dominik Wiedenhofer, Fridolin Krausmann, Philip Nuss and Gian Andrea Blengini.** 2014. 'Measuring progress towards a circular economy: A monitoring framework for economy-wide material loop closing in the EU28'. *Journal of Industrial Ecology* 23 (1): 62–76. <https://doi.org/10.1111/jiec.12809>.
- Mechati, F., E. Roth, V. Renault, V. Risoul, G. Trouvé and P. Gilot.** 2004. 'Pilot scale and theoretical study of thermal remediation of soils'. *Environmental Engineering Science* 21 (3): 361–370. <https://doi.org/10.1089/109287504323067003>.
- Medhora, Shalailah.** 2016. 'Feuds and infighting as nuclear waste dump plan tears communities apart'. *The Guardian*, 1 March. [www.theguardian.com/environment/2016/mar/01/feuds-and-infighting-as-nuclear-waste-dump-plan-tears-communities-apart](http://www.theguardian.com/environment/2016/mar/01/feuds-and-infighting-as-nuclear-waste-dump-plan-tears-communities-apart).

- Metcalf & Eddy, Inc., **George Tchobanoglous**, **H. Stensel**, **Ryujiro Tsuchihashi** and **Franklin Burton**. *Wastewater Engineering: Treatment and resource recovery*, 5th edition. New York: McGraw Hill Education.
- METI. 2023. '3R policies'. Website of METI: Ministry of Economy, Trade and Industry, Japan. [www.meti.go.jp/english/policy/energy\\_environment/3r/index.html](http://www.meti.go.jp/english/policy/energy_environment/3r/index.html).
- Middleton, Joe** and agencies. 2022. 'Man who threw away £150m in Bitcoin hopes AI and robot dogs will get it back'. *The Guardian*, 2 August 2022. [www.theguardian.com/technology/2022/aug/02/man-hopes-ai-and-robot-dogs-will-help-recover-150m-in-bitcoin-from-landfill](http://www.theguardian.com/technology/2022/aug/02/man-hopes-ai-and-robot-dogs-will-help-recover-150m-in-bitcoin-from-landfill).
- Ministry of the Environment. 2005. *Japan's Experience in Promotion of the 3Rs: For the establishment of a sound material-cycle society*. Tokyo: Ministry of the Environment.
- Möller, Kurt** and **Torsten Müller**. 2012. 'Effects of anaerobic digestion on digestate nutrient availability and crop growth: A review'. *Engineering in Life Sciences* 12 (3): 242–257. <https://doi.org/10.1002/elsc.201100085>.
- Nakou, D.**, **Andreas Benardos**, and **Dimitris Kaliampakos**. 2014. 'Assessing the financial and environmental performance of underground automated vacuum waste collection systems'. *Tunnelling and Underground Space Technology* 41 (1): 263–271. <https://doi.org/10.1016/j.tust.2013.12.005>.
- NAWMA. 2023. 'Waste hierarchy'. Northern Adelaide Waste Management Authority. [www.nawma.sa.gov.au/education-resources/waste-hierarchy/](http://www.nawma.sa.gov.au/education-resources/waste-hierarchy/).
- Excel Dryer, Inc. v. Dyson, Inc.* Civil Action No. 12-30211-MAP. 2014.
- Neuwahl, Frederik**, **Gianluca Cusano**, **Jorge Gómez Benavides**, **Simon Holbrook** and **Roudier Serge**. 2019. Best Available Techniques (BAT) reference document for waste treatment industries. Industrial Emissions Directive 2010/75/EU (Integrated Pollution Prevention and Control). <https://doi.org/10.2760/761437>.
- Nodjimbadem, Katie**. 2017. 'The trashy beginnings of "Don't Mess with Texas": A true story of the defining phrase of the Lone Star State'. *Smithsonian Magazine*, March 10, 1–3.
- OECD. 2004. Addressing the Economics of Waste, OECD Workshop, Paris, October.
- OECD. 2008. 'Measuring Material Flows and Resource Productivity Volume 1 The OECD Guide'. *Volume 1*.
- OECD. 2015. Municipal Waste, Generation and Treatment. <https://stats.oecd.org/index.aspx?DataSetCode=MUNW>.
- OECD. 2018. *Improving Markets for Recycled Plastics: Trends, prospects and policy responses*. Paris: Organization for Economic Development.
- Opray, Max**. 2017. 'Who'd want to dump Australia's nuclear waste here? Well, this guy'. *The Guardian*, 3 April 2017. [www.theguardian.com/environment/2017/apr/04/whod-want-to-dump-australias-nuclear-waste-here-well-this-guy](http://www.theguardian.com/environment/2017/apr/04/whod-want-to-dump-australias-nuclear-waste-here-well-this-guy).



- Peng, Wei and Alberto Pivato.** 2019. 'Sustainable management of digestate from the organic fraction of municipal solid waste and food waste under the concepts of back to earth alternatives and circular economy'. *Waste and Biomass Valorization* 10 (2): 465–481. <https://doi.org/10.1007/s12649-017-0071-2>.
- PlasticsEurope. 2017. *Plastics – the Facts 2017: An analysis of European plastics production, demand and waste data*. Association of Plastics Manufacturers. <https://plasticseurope.org/wp-content/uploads/2021/10/2017-Plastics-the-facts.pdf>.
- Potting, José, Marko Hekkert, Ernst Worrell and Aldert Hanemaaijer.** 2017. *Circular Economy: Measuring innovation in the Product Chain*. Policy report. Amsterdam: PBL Netherlands Environmental Assessment Agency.
- Prakash, Aseem and Matthew Potoski.** 2007. 'Collective action through voluntary environmental programs: A club theory perspective'. *Policy Studies Journal* 35 (4): 773–792. <https://doi.org/10.1111/j.1541-0072.2007.00247.x>.
- Rahman, Abdul, Mohammad Hariz, Tosiah Sadi, Aimi Athirah Ahmad, Intan Nadhirah Masri, Masnira Mohammad Yusoff, Hasliana Kamaruddin, Nur Alyani Shakri, Mohamad Abhar Akmal Hamid and Rashidah Ab. Malek.** 2020. 'Inventory and composting of yard waste in Serdang, Selangor, Malaysia'. *Heliyon* 6 (7): e04486. <https://doi.org/10.1016/j.heliyon.2020.e04486>.
- Rankin, William John.** 2011. '13 secondary materials and recycling'. In *Minerals, Metals and Sustainability: Meeting future material needs*, 271–294. Clayton: Csiro Publishing.
- Rocheftort, David A. and Roger W. Cobb.** 1993. 'Problem definition, agenda access, and policy choice'. *Policy Studies Journal* 21 (1): 56–71. <https://doi.org/10.1111/j.1541-0072.1993.tb01453.x>.
- Rose, Colin, Dan Bergsagel, Thibault Dufresne, Evi Unubreme, Tianyao Lyu, Philippe Duffour and Julia Stegemann.** 2018. 'Cross-laminated secondary timber: Experimental testing and modelling the effect of defects and reduced feedstock properties'. *Sustainability* 10 (11): 4118. <https://doi.org/10.3390/su10114118>.
- Roy, Inori.** 2020. 'UK waste incinerators three times more likely to be in poorer areas'. *Unearthed*, 31 July. <https://unearthed.greenpeace.org/2020/07/31/waste-incinerators-deprivation-map-recycling/#:~:text=There are currently at least,medical waste and waste wood>.
- Rueda-Avellaneda, Juan Felipe, Pasiano Rivas-García, Ricardo Gomez-Gonzalez, Reyes Benitez-Bravo, José Enrique Botello-Álvarez and Salvador Tututi-Avila.** 2021. 'Current and prospective situation of municipal solid waste final disposal in Mexico: A spatio-temporal evaluation'. *Renewable and Sustainable Energy Transition* 1 (August): 100007. <https://doi.org/10.1016/j.rset.2021.100007>.

- Saarikoski, Heli.** 2006. 'When frames conflict: Policy dialogue on waste'. *Environment and Planning C: Politics and Space* 24 (4): 615–631. <https://doi.org/10.1068/c53m>.
- Sabatier, Paul A.,** ed. 2007. *Theories of the Policy Process*, 2nd edition. Boulder, CO: Westview Press.
- Schmidt, Jannick H., Peter Holm, Anne Merrild and Per Christensen.** 2007. 'Life cycle assessment of the waste hierarchy: A Danish case study on waste paper'. *Waste Management* 27 (11): 1519–1530. <https://doi.org/10.1016/j.wasman.2006.09.004>.
- Seyler, Christina, Stefanie Hellweg, Michel Monteil and Konrad Hungerbühler.** 2005. 'Life cycle inventory for use of waste solvent as fuel substitute in the cement industry: A multi-input allocation model (11 Pp)'. *The International Journal of Life Cycle Assessment* 10 (2): 120–130. <https://doi.org/10.1065/lca2004.08.173>.
- Shen, Li and Ernst Worrell.** 2014. 'Plastic recycling'. In *Handbook of Recycling: State-of-the-Art for Practitioners, Analysts, and Scientists*, ed. by Ernst Worrell and Markus A. Reuter, 179–190. Amsterdam: Elsevier.
- Shepon, Alon, Gidon Eshel, Elad Noor and Ron Milo.** 2016. 'Energy and protein feed-to-food conversion efficiencies in the US and potential food security gains from dietary changes'. *Environmental Research Letters* 11 (10): 105002. <https://doi.org/10.1088/1748-9326/11/10/105002>.
- Shepon, Alon, Gidon Eshel, Elad Noor and Ron Milo.** 2018. 'The opportunity cost of animal based diets exceeds all food losses'. *PNAS* 115 (15): 3804–3809. <https://doi.org/10.1073/pnas.1713820115>.
- SL Corp. 2021. '20 years of SLC in numbers'. Sudokwon Landfill Site Management Corp. [www.slc.or.kr/slc/eng/board/bdFileEngView.do#/eyJiZE5vIjoxLCJwYWdlIjoxLCJiY0lkIjoiZW5nX0IiLCJ3ZWJQYWdlTm8iOjgyMiwidGFiVm8iOjEsInByZVVSTCI6Ii9lbmcvaW5kZXhfZW5nLmRvIn0=.](http://www.slc.or.kr/slc/eng/board/bdFileEngView.do#/eyJiZE5vIjoxLCJwYWdlIjoxLCJiY0lkIjoiZW5nX0IiLCJ3ZWJQYWdlTm8iOjgyMiwidGFiVm8iOjEsInByZVVSTCI6Ii9lbmcvaW5kZXhfZW5nLmRvIn0=.)
- Sonnemann, Guido and Sonia Valdivia.** 2017. 'Medellin Declaration on Marine Litter in Life Cycle Assessment and Management: Facilitated by the Forum for Sustainability through Life Cycle Innovation (FSLCI) in close cooperation with La Red Iberoamericana de Ciclo de Vida (RICV) on Wednesday 14 of June 2017'. *International Journal of Life Cycle Assessment* 22 (10): 1637–1639. <https://doi.org/10.1007/s11367-017-1382-z>.
- Steffen, Will, Katherine Richardson, Johan Rockström et al.** 2015. 'Planetary boundaries: Guiding human development on a changing planet'. *Science* 347 (6223). <https://doi.org/10.1126/science.1259855>.
- Strauss, Ilana.** 2022. 'How GM invented planned obsolescence'. Treehugger, 4 August. [www.treehugger.com/how-planned-obsolescence-began-4856701](http://www.treehugger.com/how-planned-obsolescence-began-4856701).

- Stuart, Tristram.** 2009. *Waste: Uncovering the global food scandal*. New York: WW Norton & Company.
- Suh, Sangwon and Gjalt Huppes.** 2002. 'Missing inventory estimation tool using extended input-output analysis'. *The International Journal of Life Cycle Assessment* 7 (3): 134–140. <https://doi.org/10.1007/BF02994047>.
- Sweco. 2015. Environmental and Social Impact Assessment (ESIA) 1 (1989230000). Autonomous Republic of Ajara, Georgia. London: European Bank for Reconstruction and Development.
- The Hamilton Spectator.* 2016. 'Hagersville fire caused by spontaneously combusting shredded rubber'. 12 September. [www.thespec.com/news/hamilton-region/hagersville-fire-caused-by-spontaneously-combusting-shredded-rubber/article\\_adfe304c-3e59-54fc-8af1-b4929ad1681c.html](http://www.thespec.com/news/hamilton-region/hagersville-fire-caused-by-spontaneously-combusting-shredded-rubber/article_adfe304c-3e59-54fc-8af1-b4929ad1681c.html).
- UK Government. 2019. Landfill Tax Bulletin. May. London.
- UL Environment. 2016. Product Category Rules (PCR) For Preparing an Environmental Product Declaration (EPD) for the Product Category: HAND DRYERS.
- UNECE. 2018. 'Specifications for the application of the United Nations Framework Classification for Resources to Anthropogenic Resources'. <https://doi.org/https://doi.org/10.5281/zenodo.3759026>.
- UNEP. n.d. 'Toolkit for establishing laws to eliminate lead paint'. United Nations Environment Programme, n.d. [www.unep.org/toolkit-establishing-laws-eliminate-lead-paint](http://www.unep.org/toolkit-establishing-laws-eliminate-lead-paint).
- UNEP. 2011. *UNEP Recycling Rates of Metals: A Status Report*. Nairobi: United Nations Environment Programme.
- UNEP. 2019. 'Entry into force of amendment to UN Treaty boosts efforts to prevent waste dumping'. Website of the Basel Convention, press release, 13 September. [www.basel.int/Default.aspx?tabid=8120](http://www.basel.int/Default.aspx?tabid=8120).
- UNEP. 2020. *Guidelines for Social Life Cycle Assessment of Products and Organizations 2020*. Nairobi: United Nations Environment Programme.
- UNEP/ISWA. 2015. *Global Waste Management Outlook*. Nairobi/Stuttgart: UN Environment Programme; Universität Stuttgart Institut für Siedlungswasserbau Wassergüte- und Abfallwirtschaft. [www.unep.org/resources/report/global-waste-management-outlook](http://www.unep.org/resources/report/global-waste-management-outlook).
- UNEP/SBC. n.d. *The Basel Convention at a Glance*. Nairobi/Geneva: Secretariat of the Basel Convention; United Nations Environment Programme.
- United States District Court District of Massachusetts. 2012. *Excel Dryer, Inc. v. Dyson, Inc.* Case 3:12-cv-30211-KPN. Memorandum in support of plaintiff's motion for preliminary injunction.
- United States District Court District of Massachusetts. 2014. *Excel Dryer, Inc. v. Dyson, Inc.* Case 3:12-cv-30211-KPN. Memorandum and order with regard to Dyson Inc.'s motion for a protective order.

- Ur'yash, V. F., V. N. Larina, N. Yu Kokurina and N. V. Novoselova.** 2010. 'The thermochemical characteristics of cellulose and its mixtures with water'. *Russian Journal of Physical Chemistry A* 84 (6): 915–921. <https://doi.org/10.1134/S0036024410060051>.
- US EPA. 2015. 'Documentation for greenhouse gas emission, energy and economic factors used in the Waste Reduction Model (WARM)'. United States Environmental Protection Agency. [www.epa.gov/warm/documentation-chapters-greenhouse-gas-emission-energy-and-economic-factors-used-waste](http://www.epa.gov/warm/documentation-chapters-greenhouse-gas-emission-energy-and-economic-factors-used-waste).
- US EPA. 2020. *Advancing Sustainable Materials Management: Facts and Figures*. Washington, DC: United States Environmental Protection Agency, 1–16.
- US EPA. 2022. 'Class I Industrial and Municipal Waste Disposal Wells'. United States Environmental Protection Agency. [www.epa.gov/uic/class-i-industrial-and-municipal-waste-disposal-wells#haz\\_well](http://www.epa.gov/uic/class-i-industrial-and-municipal-waste-disposal-wells#haz_well).
- USTMA. 2020. *2019 U.S. Scrap Tire Market Summary*. Washington, DC: US Tire Manufacturers' Association.
- Van Ewijk, Stijn.** 2018. *Resource Efficiency and the Circular Economy: Concepts, economic benefits, barriers, and policies – EV0276*. London: Department for Environment, Food & Rural Affairs (Defra).
- Van Ewijk, Stijn, Weslyne S. Ashton, Peter Berrill, Zhi Cao, Marian Chertow, Shauhrat S. Chopra, Tomer Fishman, Colin Fitzpatrick, Oliver Heidrich, Sina Leipold, Frenzi Ritter, Benjamin Sprecher, Yuan Yao and Rupert J. Myers.** 2023. *Ten Insights from Industrial Ecology for the Circular Economy*. Leiden: International Society for Industrial Ecology (ISIE).
- Van Ewijk, Stijn, Julia A. Stegemann and Paul Ekins.** 2018. 'Global life cycle paper flows, recycling metrics, and material efficiency'. *Journal of Industrial Ecology* 22 (4): 686–693. <https://doi.org/10.1111/jiec.12613>.
- Vanclay, Frank, Ana Maria Esteves, Ilse Aucamp and Daniel M. Franks.** 2015. 'Social impact assessment: Guidance for assessing and managing the social impacts of projects'. International Association for Impact Assessment, April. [www.iaia.org/news-details.php?ID=3](http://www.iaia.org/news-details.php?ID=3).
- Venkata Mohan, S., M.V. Rohit, K. Amulya, A. Naresh Kumar, J. Annie Modestra, J. Shanthi Sravan, Manupati Hemalatha, Sulogna Chatterjee, Palle Ranadheer and K. Swathi.** 2019. 'Acidogenic biohydrogen production integrated with biorefinery approach'. In *Biohydrogen*, second edition, ed. by Ashok Pandey, S. Venkata Mohan, Jo-Shu Chang, Patrick C. Hallenbeck and Christian Larroche. Amsterdam: Elsevier, 369–381.
- Wagner, Travis P. and Patti Toews.** 2018. 'Assessing the use of default choice modification to reduce consumption of plastic straws'. *Detritus* 4: 113–121. <https://doi.org/10.31025/2611-4135/2018.13734>.

- Wahlquist, Calla.** 2016. 'Indigenous owners outraged at site earmarked for Australia's first nuclear waste dump'. *The Guardian*, 29 April 2016. [www.theguardian.com/environment/2016/apr/29/indigenous-elders-outraged-at-site-earmarked-for-australias-first-nuclear-waste-dump](http://www.theguardian.com/environment/2016/apr/29/indigenous-elders-outraged-at-site-earmarked-for-australias-first-nuclear-waste-dump).
- Wang, Hongtao and Yongfeng Nie.** 2001. 'Municipal solid waste characteristics and management in China'. *Journal of the Air & Waste Management Association* 51 (2): 250–263. <https://doi.org/10.1080/10473289.2001.10464266>.
- Weidema, Bo Pedersen and Marianne Suhr Wesnæs.** 1996. 'Data quality management for life cycle inventories: An example of using data quality indicators'. *Journal of Cleaner Production* 4 (3–4): 167–174. [https://doi.org/10.1016/S0959-6526\(96\)00043-1](https://doi.org/10.1016/S0959-6526(96)00043-1).
- WHO. 2017. *Guidelines for Drinking-Water Quality: Fourth Edition Incorporating the First Addendum*, Volume 55. Geneva: World Health Organization.
- Wiedmann, Thomas O., Heinz Schandl, Manfred Lenzen, Daniel Moran, Sangwon Suh, James West and Keiichiro Kanemoto.** 2015. 'The material footprint of nations'. *Proceedings of the National Academy of Sciences* 112 (20): 6271–6276. <https://doi.org/10.1073/pnas.1220362110>.
- Woods, John S., Gorm Rødder and Francesca Verones.** 2019. 'An effect factor approach for quantifying the entanglement impact on marine species of macroplastic debris within life cycle impact assessment'. *Ecological Indicators* 99 (December): 61–66. <https://doi.org/10.1016/j.ecolind.2018.12.018>.
- Worldsteel Association. 2018. 'Global crude steel output increases by 4.6% in 2018'. Worldsteel Association press release, 25 January. <https://worldsteel.org/wp-content/uploads/Press-release---Global-crude-steel-output-increases-by-4.6-in-2018.pdf>.
- WRAP. n.d. 'Waste prevention case studies'. Wastes and Resources Action Programme. [https://archive.wrap.org.uk/sites/files/wrap/Waste%20prevention%20case%20studies\\_0.pdf](https://archive.wrap.org.uk/sites/files/wrap/Waste%20prevention%20case%20studies_0.pdf).
- WRAP. 2018. 'Gate Fees 2017/18: Comparing the costs of alternative waste treatment options'. June. <https://wrap.org.uk/resources/guide/gate-fees-report-2018>.
- WRI. 2022. *Climate Watch: Historical GHG Emissions*. Washington, DC: World Resources Institute.
- Xu, Fuqing, Solomon Inalegwu Okopi, Yongmei Jiang, Zhou Chen, Liyun Meng, Yebo Li, Weimin Sun and Chaokun Li.** 2022. 'Multi-criteria assessment of food waste and waste paper anaerobic co-digestion: Effects of inoculation ratio, total solids content, and feedstock composition'. *Renewable Energy* 194: 40–50. <https://doi.org/10.1016/j.renene.2022.05.078>.

- Xu, Fuqing, Zhi Wu Wang and Yebo Li.** 2014. 'Predicting the methane yield of lignocellulosic biomass in mesophilic solid-state anaerobic digestion based on feedstock characteristics and process parameters'. *Bioresource Technology* 173: 168–176. <https://doi.org/10.1016/j.biortech.2014.09.090>.
- Young, Michelle.** 2020. 'Inside Roosevelt Island's futuristic pneumatic tube trash system'. Untapped New York, n.d. <https://untappedcities.com/2020/04/09/inside-roosevelt-islands-futuristic-pneumatic-tube-trash-system/>.
- Zenas Engineering PLC. 2010. *Dilla Sanitary Landfill Project Environmental Impact Assessment Report*. Abidjan: African Development Bank.
- Zhou, Chuanbin, Zhe Gong, Junsong Hu, Aixin Cao and Hanwen Liang.** 2015. 'A cost-benefit analysis of landfill mining and material recycling in China'. *Waste Management* 35 (January): 191–198. <https://doi.org/10.1016/j.wasman.2014.09.029>.
- Zink, Trevor and Roland Geyer.** 2017. 'Circular economy rebound'. *Journal of Industrial Ecology* 21 (3): 593–602. <https://doi.org/10.1111/jiec.12545>.

## INDEX

- abiotic material 14, 314, 316
- accidents, waste facility 51–2
- acetogenesis (anaerobic digestion) 277, 292
- achieving circularity
  - beyond circularity 345–6
  - measuring progress 336–9
  - regime change 341–3
  - system inertia 339–41
  - transition management 343–5
- achieving prevention
  - EPR scheme for textiles in France 160–1
  - extended producer responsibility (EPR) 159–60
  - green engineering 157–8
  - role of product design 157, 158, 229, 235, 245–7
  - waste prevention policies 158–9
- acid gases 195, 198, 265, 267, 303
- acidification 47, 83–5
- acidogenesis (anaerobic digestion) 277, 278
- acid rain 266, 281
- acids (common pollutant) 50
- activated sludge process 201, 203, 207
- Adjara Solid Waste Project, Georgia 93
- admixture (low-grade recycling) 251
- adsorbents (low-grade recycling) 251
- adsorption, pressure swing 281
- adsorption process 197, 199, 203, 266
- advanced recycling 234–5
- aerobic decomposition 292
- aerobic treatment of wastewater and gases 201, 202–5
- aerospace market 341
- aesthetics (environmental impact) 51
- aggregate 97, 244, 271
- aggregate (low-grade recycling) 250
- agriculture, forestry and fishing 14–15
- Ahrend 333
- air classification 193
- air pollution control residue (APCR) 71, 270–1
- air pollution control systems 263, 269
- air-/steam-stripping 208, 210
- algae 283
- allocation (LCA) 80–1
- aluminium recycling 222
- amine scrubbing 281
- ammonia (common pollutant) 50–1, 280
- anaerobic degradation 277, 278
- anaerobic digestion 272–83
  - biogas generation and use 207, 248, 259, 280–1
  - digestate processing and use 282–3
  - digestion 276–8
  - facilities 61–2, 179
  - feedstock preparation 274–6
  - moisture content 258
  - production of biogas and fertiliser 272–3
  - treatment 200–3, 207, 237, 248
- animals
  - feed 147, 248
  - household waste and 167–8
  - manure 177–8, 206
  - waste 16
- anti-litter campaigns 123–4
- aquatic life 42, 49, 51, 283



- ash
  - categorised 13
  - combined 269
  - content in waste types 258–9
  - fly 267, 269, 271
  - household 167
  - IBA 269–71
  - landfilled 21, 120
  - management 213, 269–71
- assessment methods 64–100
  - exercises 74, 86–7
  - introduction 65
  - learning objectives 64
  - lifecycle assessment (LCA) 74–89
    - bias and independence 87–9
    - contested evidence 88–9
    - functional unit (LCA) 75, 77
    - goal and scope 77–9
    - impact assessment 81–5
    - interpretation 85–6
    - inventory analysis 79–80
    - main steps 76
    - paper waste hierarchy 79–81, 84–5, 86
    - purpose of 74–5
    - understanding an 86–7
    - ‘zero-burden’ approach 76–7
  - material flow analysis (MFA) 66–74
    - data collection and calculations 70–1
    - key concepts 68–9
    - purpose of 66–7
    - studies 67–8
    - uncertainty and limitations 71–3
  - other methods 89–100
    - cost-benefit analysis (CBA) 93–5
    - environmental impact assessment (EIA) 90–1
    - environmentally extended input-output (EEIO) analysis 90, 96–8
    - overview 89–90
    - social impact assessment (SIA) 91–3
    - review 100
    - summary 99
- auditing, waste 28–9, 147, 175
- automated vacuum collection system (AVAC) 170–1
- autonomy (consumption) 7
- avoidance, waste *see* prevention, waste
- avoid impacts (SIA) 92
- backfilling and land application 300–2
  - criteria 300
- baghouse 193, 267
- ballistic separator 179, 192
- Bangalore, India 18
- Bangladesh 133
- Basel Convention on the Control of Transboundary Movements of Hazardous Wastes and their Disposal (1989) 111, 120
- basic waste data 17
- batteries 246, 326
- beer, brewing 147
- best available techniques, European (BAT) 176–8, 265
- bias and independence (LCA) 87–9
- bin liners 167–8, 262
- biodegradability 49, 200, 236–7, 325
- biodrying 259
- biofilter 201, 205
- biogas generation and use
  - anaerobic digestion 207, 248, 272–4, 278–82
  - technologies 179, 281
  - untreated 280
- biological oxygen demand (BOD) 200, 201, 290, 291, 292
- biological treatment 200–7



- anaerobic treatment 207
- general principles 200–2
- mechanical-biological treatment
  - (MBT) facility 180–1, 212
  - technologies 179, 201–2
- biomass 4–5, 13, 231–2, 274–83, 337–8
- biomethane 281
- bioplastics 236–7, 278
- biorefinery 278, 279
- biotic material 4, 14, 26, 314, 316, 322, 326, 328
- Bitcoins, landfill mining of 297–8
- boilers 263, 269
- bottle deposit-return system 233
- bottom ash, incinerator 269–71
- Boulding, Kenneth E. 309
- brick-concrete 18
- brick-wood 18
- Bullard, Dr Robert 286
- business models (circular economy) 326–8
- byproducts
  - animal 277, 283
  - biogas production 283
  - definitions 114, 135, 175
  - lack of markets 330
  - from pulping 241
- cadmium poisoning 106
- Calthorpe Community Garden, London 273
- Camley Street Natural Park, London 273–4
- capacity and resources (policy) 133
- carbon dioxide (CO<sub>2</sub>) 93–4
  - biogas 280
  - cement and 244
  - climate link 45, 81, 127
  - EEIO analysis 96
  - emissions 27, 46, 48, 293
  - methane and 51, 207
- carbon footprint 323
- carbon monoxide (CO) 265–6
- Carbon to nitrogen (C:N) ratios 274, 275, 280
- carbon particles 195
- cars
  - discarded tyres 251–3
  - electric 341, 343
  - recycling metals 227
  - scrapped 19
  - use 143–4
- catalytic oxidation 209
- cellulose 258, 259
- cement 71, 198, 244, 259
  - kilns 212, 244
- ceramic industry 302
- CH<sub>4</sub> (methane) 51, 81, 206, 272, 277, 280, 293
- challenges of waste 30–6
  - contaminated resource 32–4
  - systemic interactions 34–6
  - unwanted material 30–2
- chemical oxygen demand (COD) 290
- chemical recycling 231, 234–5
- Chempark Factory, Germany 186
- China 18, 95, 98, 166, 335
  - waste laws 110, 111, 112, 113
- cholera outbreak, London (1854) 107–8
- circular economy 105–6, 306–48
  - achieving circularity
    - beyond circularity 345–6
    - measuring progress 336–9
    - regime change 341–3
    - system inertia 339–41
    - transition management 343–5
  - butterfly diagram 315
  - circular strategies 324–36

- business models 326–8
- industrial symbiosis 333–6
- levels of action 324
- product design 324–6
- reverse logistics 332–3
- supply chains 329–31
- exercises 318, 328, 336, 338–9
- imperfect circle 224
- intellectual history of 309–10
- introduction 307
- land fill and 297
- learning objectives 306
- making a profit 328
- management options 27
- material circularity 314–23
  - limits to circularity 321–3
  - material loops 314–16
  - from the three Rs to the 10 Rs 316–8
  - value creation 318–21
- MFA studies 67
- review 347–8
- summary 346–7
- sustainability goals 308–14
  - circularity in brief 308–10
  - economy 311
  - environment 310
  - society 311–14
- circularity in brief 308–10
- circular strategies 324–36
  - business models 326–8
  - industrial symbiosis 333–6
  - levels of action 324
  - product design 324–6
  - reverse logistics 332–3
  - supply chains 329–31
- clarification process 183
- classification, waste 114–17
- clay, landfill siting and 286, 287
- cleaner production 144
- clean or biotic products (business models) 328
- climate change 47, 127, 343
- clinker residue 244
- closed-loop recycling 217, 220–1, 223, 264
- clothing and footwear industry 326, 333
- CO<sub>2</sub> (carbon dioxide) 93–4
  - biogas 280
  - cement and 244
  - climate link 45, 81, 127
  - EEIO analysis 96
  - emissions 27, 46, 48, 293
  - methane and 51, 207
- coagulation and flocculation process 182–3, 199
- coal 212–13, 244, 257, 259, 262
- coffee cups, reusable 154, 345
- collection and treatment 164–215
  - biological treatment 200–7
    - aerobic treatment of solid wastes (composting) 205–6
    - aerobic treatment of wastewater and gases 202–5
    - anaerobic treatment 207
    - general principles 200–2
    - mechanical-biological treatment (MBT) facility 180–1, 212
  - exercises 187, 194
  - introduction 165
  - learning objectives 164
  - physical treatment 185–95
    - mixing 190
    - separation 191–5
    - size reduction 187–9
    - storage 185–7
  - physicochemical treatment 195–9
    - gases 195

- purpose and concept 195
- solid wastes 198
- wastewaters 196–8
- review questions 214–15
- summary 213–14
- thermal treatment 208–13
  - purpose and concept 208–9
  - temperature-based separations 209–11
  - thermal destruction of waste and contaminants 211–13
- waste collection 166–75
  - household 167–71
  - industrial 173–5
  - infrastructure 166–7
  - source-separation of household waste 171–3, 218
- waste treatment 176–84
  - history and requirements 176–7
  - household systems 179–81
  - industrial systems 181–4
  - types of 178–9
- collection (management system) 22–3
- combined heat and power (CHP) system 264
- combustion 50, 258, 259, 262–3, 281
- commercial waste 170, 240
- community (social impacts) 57
- compensate for damage (SIA) 92
- complex products, recycling 245–7
- composting 202, 205–6, 248
- compost-like output (CLO) 181, 289
- Comprehensive Environmental Response, Compensation and Liability Act, US (1980) (CERCLA) 109
- concrete 18, 71, 244, 250
- construction and demolition (C&D) 11, 14–15, 18, 69, 71, 167, 188, 285
- consumption-based accounting (EEIO) 97–8
- consumption growth, material 6–8
- contaminated resources 32–4
  - feedstocks 282
  - MFA coprocessing 71
  - paper 33, 34, 173, 241
  - steel contaminated with copper 34, 35–6, 228
  - thermal destruction of 211–13
- contextual data 17
- conveyors 174, 193
- coordination (policy) 133
- coprocessing 71, 209, 259
- cost-benefit analysis (CBA) 90, 93–5, 271
- cost of waste management 61–2
- cost-savings (circular economy) 311
- crime, waste 30, 31–2, 119
- criticality (circular economy) 311
- critical materials, recycling 228
- cross-laminated secondary timber (CLST) 249–50
- cross-laminated timber (CLT) 249
- crushers 188, 189
- cullet (waste glass) 244
- cultural functions (ecosystem services) 42
- culture (social impacts) 57
- cutters 188
- cyclone process 193
- data collection and calculations 17, 70–1
- data quality assessment 72
- data uncertainty (MFA) 72
- decarbonisation, transportation 170
- decision-making 74, 128
- decontamination, separation and 33
- deep-well injection 300–1

- degradability 248
- Delhi, India 17–18
- demolition and construction waste
  - see* construction and demolition (C&D)
- Denmark 334–5
- design and operation, modern landfill 287–89
- design, policy 131–3
- design, product 157, 158, 229, 235, 245–7
  - circular strategies 324–6
- desorption, thermal 208, 210
- destruction, thermal 208–9, 211–13
- developed countries 54, 104, 132
- developing countries 32, 105, 132–3
- digestate processing and use 282–3
  - compost and 248
  - dried samples 282–3
  - excess 283
  - liquid/solid fractions 282–3
  - regulations 283
- digesters 273, 276–8
- digestion 276–9
- digital sorter/air knife process 193
- Dilla City, Ethiopia 91
- dilution 34, 35–6
- dioxins (PCDDs) 265–6
- disinfection 208, 211
- disc/disk screen 179, 191
- disposal, energy recovery and *see* energy recovery and disposal
- disposal, waste
  - Basel Convention 111, 120
  - by landfilling 284–6
  - lifecycle stage 11
  - management system 22–3, 251
  - other land waste 299–300
  - solid waste US Act 108
- dissolved-air flotation 192
- distance (industrial symbiosis) 335
- distillation 208, 210–11, 232
- domestic material consumption (DMC) 97–8
- door-to-door logistics (reverse logistics) 332
- DPSIR framework (drivers, pressures, states, impacts and responses) 44–6, 336–7
- drivers of waste management 104–9
  - environmental protection 108–9
  - overview 104–5
  - public health 107–8
  - resource value of waste 104, 105–6
- driving forces (DPSIR) 44–5
- drying, thermal 208, 209–10
- ‘dry’ materials 173
- dumpsters 174
- durable products 14, 188
- dust (common pollutant) 50
- Dyson 88
- ecology, industrial 310
- economics
  - equality 312
  - growth 6
  - instruments 124–6
  - of waste 58–62
  - See also* circular economy
- economics of waste
  - cost of waste management 61–2
  - linear economy 308, 339
  - material life cycle 12–14
  - sectors 96–8, 257–9
  - of wastage 141–3
  - waste versus non-waste 58–60
- economy-wide material lifecycle 12–14
- ecosystems
  - lifecycle assessment 47–8

- natural 4–5
- protection of 283, 310
- risk assessments 300
- services 42–3
- ecotoxicity 47
- eddy-current separation 193
- effectiveness (policy design criteria) 131
- efficiency
  - material flow indicator 338
  - production and manufacturing 144–9
    - environmental benefits of lean manufacturing 148–9
    - internal cycling 148
    - light-weighting 144–5
    - materials substitution 145–6
    - phasing out lead-based paint 146, 153–4
    - yield improvement 147
  - resource 27
  - use 149–52
    - intensity of transport use 151–2
    - planned obsolescence 150–1
    - product longevity 149–50
    - product reuse 153
- electrical and electronic equipment, waste (WEEE) 172, 245–7, 333
- electrical energy generation 259–60, 264, 281
- electric cars 341, 343
- electricity supply (socio-technical systems) 341
- electrostatic precipitation 193
- electro-winning process 199
- Ellen MacArthur Foundation 344
- end-of-life waste 20, 227, 246, 252–3, 259
- end-point indicators (LCI) 82, 83
- energy, lost 264
- energy recovery and disposal 256–304
  - anaerobic digestion 272–84
    - biogas generation and use 280–81
    - digestate processing and use 282–3
    - digestion 276–9
    - feedstock preparation 274–6
    - production of biogas and fertiliser 272–4
  - exercises 275, 302
  - introduction 257
  - landfill of municipal solid waste 284–98
    - design and operation 287–89
    - disposal of waste by landfilling 284–5
    - gas collection and recovery 292–6
    - landfill closure and mining 296–8
    - landfill siting 285–6
    - leachate collection and treatment 289–2
  - learning objectives 256
  - municipal solid waste incineration 260–71
    - ash management 269–71
    - combustion 262–3
    - energy recovery 263–4
    - flue gas cleaning 265–8
    - fuel delivery 262
    - overview 260–2
  - other types of disposal and recovery 299–303
    - backfilling and land application 300–2
    - land disposal of other waste 299–300
  - review questions 303–4
  - summary 302–3
  - waste as fuel 257–60

- enforcement (policy) 134
- environment
  - benefits of recycling 223–4
  - circular economy 312
  - circular economy and 310
  - damage to natural 82
  - EEIO analysis 90, 96–8
  - impact assessments 90–1, 93
  - impacts of waste 44–52
    - DPSIR framework 44–6
    - pollutants and hazards 49–52
    - quantities of materials and 73
    - social 57
    - types of 46–9
  - land siting and justice 286
  - lean manufacturing 148–9
  - limits 44
  - management system 174
  - material processes 9, 10
  - NGOs 130–1
  - problems 39, 46–7
  - protection 108–9
  - social costs and benefits 94
  - sustainability 40–4, 248
- equipment, waste handling 16, 174–5, 188–9
- estimating waste generation 17–21
- European Union (EU)
  - biomass in 337–8
  - waste laws 52, 110, 111, 112–13, 123
- eutrophication 47, 84–5, 200, 283
- evaluation and implementation, policy 133–4
- excavators 174
- Excel Dryer 88–9
- excessive packaging (supply chains) 329–30
- expanded polystyrene (EPS) 233
- Extended Producer Responsibility (EPR) 159, 160–1
- extraction 10
- fears and aspirations (social impacts) 58
- feasibility (policy design criteria) 131
- feedstocks
  - characteristics for anaerobic digestion 275
  - contaminated 282
  - preparation 274–5
  - properties 275, 282
  - secondary 219, 223, 230
- fertilisers 80, 96, 120, 207, 213, 272–4, 283
- filler (low-grade recycling) 251
- filter pressing 182–3
- filtration 192, 203
- Finland 130
- fires, landfill 186, 293
- float separation 233
- flocculation and coagulation process 182–3, 199
- flotation, dissolved-air 192
- flows, material *see* material flow analysis (MFA)
- flue gas
  - cleaning 265–8, 334
  - temperature 263, 264
  - untreated composition of 265
- fluidised-bed reactor, biological 201
- food
  - containers 146
  - packaging
    - audit 29–30
    - socio-technical systems 341, 342
    - systemic interactions 34
  - sellors 142–3, 248, 330
  - waste 60, 179, 205, 259

- forest carbon storage 222–3
- fossil-based plastics 236
- fossil energy 4–5, 13
- fossil fuels 39, 170, 231–2, 235, 259
- France 267
- freeze crystallisation 208, 211
- fuel delivery 262
- fuel, waste as a 257–60
  - characteristics 258–9
- functional unit (LCA) 75, 77
- furans (PCDFs) 265–6
- furniture manufacturer 333
  
- garbage bags 167–8, 262
- garden waste 205–6
- gas
  - aerobic treatment of 202–5
  - generation 294–5, 296
  - landfill collection and recovery 292–6
    - stages 292
  - landfill composition 290
  - natural 259, 281
  - physicochemical treatment of 195–6
- gasification 209, 211–12, 213, 259
- gate fees, waste facility 61–2, 219
- generation, waste 14–21
  - estimating 17–21
  - types and quantities of waste 14–17, 26–7
- geomembrane (plastic liner) 287, 288–89
- geosynthetic clay liner (GCL) 288
- glass 173, 244, 314
- globalisation 35, 105
- global warming 43, 82, 84–5, 95, 206, 266, 277
- goods, regular 58–9
- granular media filtration 192
- gravity separation 192
  
- ‘Great Smog’, London (1952) 107
- ‘Great Stink’, London (1858) 107
- green engineering, waste prevention and 157–8
- greenhouse gas (GHG) emissions 43, 46, 66, 81, 222
- grinders 188
- gross domestic product (GDP) 97–8
- gross heating value (GHV) 258
- groundwater pollution 286, 288, 289
- Gyproc 334
- gypsum 181, 244, 334
  
- H&M 333
- hand drying systems 88–9
- hazardous waste
  - classification 16, 116
  - flame retardants 140
  - fly ash 271
  - heavy metals 140
  - household 172
  - properties 52
  - tyres 252
- hazards and pollutants 49–52, 106–9, 195, 284, 289–2, 297–8
- health and wellbeing (social impacts) 57
- health (consumption) 7
- heating values 258–9
- heat recovery 264
- hierarchy, waste 24–5, 27
- high-density polyethylene (HDPE) 232, 233, 287
- higher heating value (HHV) 258
- high-income countries 20–1, 54, 55, 97–8, 252
- Hooker Chemical Company, US 109
- hops waste 147
- households and services 14–15

- household waste
  - collection 167–71, 240
  - composting 205–6
  - landfill 285
  - scavenging animals 167–8
  - source-separation 171–3, 218
  - treatment systems 179–81
- Houston, Texas 286
- Howells, James 297–8
- human health, damage to 82, 109
- human needs 7–8
- human toxicity 47
- human waste 106–8
- hydrogen sulphide (H<sub>2</sub>S) gas 51, 280, 281
- hydrolysis (anaerobic digestion) 277
- I:CO 333
- illegal practices 30, 31–2, 110, 119, 235
- impact indicators (DPSIR) 44
- impacts of waste 38–63
  - economics of waste 58–62
    - cost of waste management 61–2
    - waste versus non-waste 58–60
  - environmental impacts of waste 44–52
    - DPSIR framework 44–6
    - pollutants and hazards 49–52
    - types of 46–9
  - exercises 48, 58
  - introduction 39–40
  - learning objectives 38
  - review 63
  - social impacts of waste 53–8
    - categories of 57–8
    - inequality and waste 54–6
    - waste and social norms 53–4
  - summary 62–3
  - sustainability and the environment 40–4
    - natural environment 41–4
- implementation and evaluation, policy 133–4
- incentives, misaligned 142
- incineration 209, 211–12, 285
- incineration, MSW 260–71
  - ash management 269–71
  - BAT Reference Document for Waste Incineration 265
  - combustion 262–3
  - energy recovery 263–4
  - flue gas cleaning 265–8
  - fuel delivery 262
  - overview 260–2
- incinerator bottom ash (IBA) 269–71
- incinerators, mass-burn 212, 260–2
- independence and bias (LCA) 87–9
- India 270
- indicator selection (LCA) 75
- Industrial and Municipal Waste Disposal Wells, USEPA Class I 301
- industrial ecology 310
- Industrial Emissions Directive (2010/75/ EU) 177
- industrialisation 106, 176
- industrial symbiosis 333–6
- industrial waste 14–15
  - characteristics of 175
  - collection 173–5
  - landfill 285
  - treatment systems 181–4
- inequality and waste 54–6
- informal waste work 55–6
- infrastructure, collection 166–7
- instruments, policy 118–26
  - economic instruments 124–6
  - information instruments 123–4
  - overview 118–19
  - regulatory instruments 119–20
  - voluntary instruments 121–2



- intensity of use (product design) 325
- intensity, waste 18
- Intergovernmental Platform on Biodiversity and Ecosystem Services (IPBES) 42
- internal cycling, waste prevention and 148
- International Association for Impact Assessment (IAIA) 91–2
- International Organization for Standardization (ISO)
  - ISO 2006 77
  - ISO 14001 121–2
- intrinsic value (nature) 42
- introduction 2–37
  - challenges of waste 30–6
    - contaminated resource 32–4
    - systemic interactions 34–6
    - unwanted material 30–2
  - drivers of material use 4–8
    - types of materials 4–5
    - why consumption grows 7–8
  - exercises 27, 29–30
  - learning objectives 2
  - material lifecycle 9–14
    - anthropogenic material system 9–10, 230
    - economy-wide 12–14
    - lifecycle stages, stocks and flows 11–12
  - review 37
  - summary 36–7
  - waste generation 14–21
    - estimating 17–21
    - types and quantities of waste 14–17, 26–7
  - waste management 21–30
    - auditing 28–30
    - options 24–7
    - system 21–3
- in-use material stocks 11–13, 224
- inventories (auditing) 28–9
- inventory analysis (LCA) 79–80
- in-vessel composting 202, 205
- ion exchange process 197, 199
- ionising radiation 47
- IPAT equation 6, 345–6
- Japan 24, 106
- Jardim Gramacho landfill, Brazil 58
- Johnson Controls 326
- jute industry 133
- Kalundborg Eco-Industrial Park, Denmark 334–5
- Khian Sea (freight ship) 120
- Kimberly-Clark 89
- knowledge and data (policy) 134
- knowledge, lack of 142
- Korea, Republic of 268, 285
- lack of byproduct markets (supply chains) 330
- lamps 246
- land application, backfilling and 300–2
- land disposal (lifecycle stage) 11
- land disposal of other waste 299–300
- landfill of municipal solid waste 284–98
  - design and operation 287–89
  - disposal of waste by landfilling 284–5
  - gas collection and recovery 292–6
  - landfill closure and mining 296–8
  - landfill siting 285–6
  - leachate collection and treatment 289–2
- landfills
  - in Brazil 58
  - in China 95

- climate change and 343
- cover 251
- cover system layers 296
- decomposition 291
- engineered 284, 287
- fires 293
- gas composition predictions 290
- gate fees 61–2, 219
- hierarchy options 24–5
- in Mexico 294–5
- mining project cost-benefit analysis 95
- potential for generation of electricity from landfill gas 296
- rates of 105
- sanitary 91, 93, 284
- siting 285–6
- UK taxation 125–6
- uncontrolled dumps 284
- in US 105
- waste-to-landfill regime 340–1
- landscape developments 342–3
- landscaping (low-grade recycling) 251
- land use 47
- late adjustment to orders (supply chain) 329
- late-stage product adjustment (supply chains) 329
- leachates 285, 288, 299
- collection and treatment 289–2
- leaching process 199
- lead-based paint, phasing out 146
- legality (policy design criteria) 132
- legislation and policy 102–36, 110–18
  - definition of waste 112–14
  - drivers of waste management 104–9
    - environmental protection 108–9
    - overview 104–5
    - public health 107–8
    - resource value of waste 104, 105–6
  - exercises 111, 132
  - introduction 103–4
  - learning objectives 102
  - legal principles 117–18
  - major laws 110–11
  - making of policy 126–34
    - defining the problem 129–31
    - implementation and evaluation 133–4
    - policy design 131–3
    - policy process 126–8
  - policy instruments 118–26
    - economic instruments 124–6
    - information instruments 123–4
    - overview 118–19
    - regulatory instruments 119–20
    - voluntary instruments 121–2
  - review 136
  - summary 135
  - waste classification 114–17
  - waste legislation 110–18
    - definition of waste 112–14
    - legal principles 117–18
    - major waste laws 110–11
    - waste classification 114–17
- legitimacy (policy design criteria) 131
- levels and scales (policy process) 128
- lifecycle assessment (LCA) 74–89
- bias and independence 87–9
- circular economy 325
- contested evidence 88–9
- EEIO analysis 97
- exercises 134
- goal and scope 77–9
- impact assessment 81–5
- interpretation 85–6
- inventory analysis 79–80

- paper waste hierarchy 79–81, 84–5, 86
- purpose of 74–6
- recycling and 223
- understanding an 86–7
- ‘zero-burden’ approach 76–7
- lifecycle impact assessment (LCIA) 74, 81, 84, 85
- lifecycle inventory (LCI) 74, 79, 80, 83, 85
- life cycles
  - manufacturing 140
  - material 9–14
    - anthropogenic material system 9–10, 230
    - economy-wide 12–14
    - lifecycle stages, stocks and flows 11–12
- light-weighting 144–5
- limitations and uncertainty (MFA) 71–3
- limits to circularity 321–2
- linear economy 308, 339
- linear low-density polyethylene (LLDPE) 233
- liquid fraction, digestate 282–3
- liquid plastic 219
- liquid waste 51, 300
- liquified natural gas (LNG) 281
- Lisbon, Portugal 320–1
- List of Wastes, European (LoW) 115, 116–17
- living laboratories 273–4
- local and global loops (material loops) 316
- local environmental impacts 51–2
- London Dumping Convention (1972) 110
- London Protocol (1996) 110
- Loop 333, 341
- loops (material flow indicator) 338
- loss on ignition (IBA) 270
- Love Canal, US 109
- Love, William T. 109
- low-carbon products 323
- low-density polyethylene (LDPE) 233, 287
- lower heating value (LHV) 258–9
- low-grade recycling 250–3
- low-impact transport (reverse logistics) 332
- low-income countries 20–1, 54, 55
- McClure, Tim 123–4
- macro-level action (circular strategies) 324, 338
- magnesium oxide (MgO) 269
- magnetic separation 193
- maintenance and repair (business models) 327
- Malaysia 206
- management, waste 21–30
  - auditing 28–30
  - options 24–7
  - system 21–3
- manufacturing (lifecycle stage) 11
- manure 177–8, 206
- marine dumping 110, 235
- marketing (circular economy) 311
- marketing (LCA) 75
- Material and product tracking (reverse logistics) 332
- material choice (product design) 324
- material circularity 314–23
  - limits to circularity 321–3
  - material loops 314–16
  - from the three Rs to the 10 Rs 316–18
  - value creation 318–21

- material flow analysis (MFA) 11–13, 66–74
  - contaminated waste coprocessing 71
  - data collection and calculations 19, 70–1
  - dynamic MFAs 67–8
  - exercises 134
  - indicators 337, 338
  - key concepts 68–9
  - purpose of 66–7
  - studies 67–8
  - uncertainty and limitations 71–3
- material inputs (material flow indicator) 337
- material intensity (product design) 325
- material life cycle 9–14
  - anthropogenic material system 9–10, 230
  - economy-wide 12–14
  - lifecycle stages, stocks and flows 11–12
- material loops 314–16
- material production 318
- material recovery *see* recycling
- material recovery facility (MRF) 21, 55, 61, 173, 179–81, 240
- materials (MFA key concept) 68
- materials/products, recycling other 242–53
  - complex products 245–7
  - low-grade recycling 250–3
  - organic waste 247–50
  - textiles, glass, cement 242–4
- material substitution 145–6
- Material Systems Laboratory (MSL), MIT 88–9
- material types 4–5
- material use, drivers of 4–8
- measuring progress, circularity and 336–9
- measuring recycling 219–21
- mechanical-biological treatment (MBT) facility 180–1, 212
- mechanical treatment 248
- membrane biological reactor 201
- membrane separation 193, 281
- mercury 68, 106, 111, 112, 196, 210, 266
- meso-level action (circular strategies) 324, 338–9
- mesophilic anaerobic digesters 277
- metal
  - flue gas phase and 266–7
  - heavy 140
  - lifecycle of steel 225
  - recovery 197–8, 269–71
  - recycling 224–30
    - benefits and challenges 228–30
    - metal production 224–6
    - recycling process 227–8
  - recycling rates of 226
  - scrap 113, 227
  - toxic 50, 106, 112, 181, 183, 184, 270, 271, 299
- metal-finishing industry 181–4
- metal ores/metals 13, 34
- methane (CH<sub>4</sub>) 51, 81, 206, 272, 277, 280, 293
- methanogenesis (anaerobic digestion) 277, 278
- methods, assessment *see* assessment methods
- Mexico 55–6, 294–5, 296
- MgO (magnesium oxide) 269
- micro-anaerobic digesters 273
- micro-level action (circular strategies) 324, 338–9
- middle-income countries 55

- mid-point indicators (LCI) 82, 83
- Millennium Ecosystem Assessment (MEA) 42
- Milton landfill site, Cambridge 293
- Minamata Convention on Mercury (2013) 111
- mineral waste (waste generation) 16
- mine tailings 299
- minimization, waste *see* prevention, waste
- mining and quarrying 14–15, 296–7
- mixed waste collection 33, 232, 239–40
- mixers/mixing 190
- model uncertainty (MFA) 71, 85, 99
- moisture content 51, 258–9
- monetary data tables (EEIO analysis) 96
- monetary exchanges (EEIO) 97
- monomers 232, 234
- municipal solid waste incineration 260–71
  - ash management 269–71
  - combustion 262–3
  - energy recovery 263–4
  - flue gas cleaning 265–8
  - fuel delivery 262
  - overview 260–2
- municipal solid waste (MSW) 20–1, 25–6, 61, 167, 258, 259
- municipal waste management sector (MWMS) 130–1
  
- natural environment 41–4, 82
- natural gas 259
- natural resources, loss of 39, 82
- near-complete recycling 106
- negative consequences (impacts of waste) 39
- Netherlands, the 105, 333
  
- Net present value (NPV) (CBA) 94
- neutralisation process 182–3, 195, 196, 197, 198, 199
- neutralizer (low-grade recycling) 250
- New Jersey, US 120
- Newport Docksway landfill site 297–8
- New York City 171
- niches, technological 342–3, 345
- ‘NIMBYism 267–8
- nitrification/denitrification 202
- nitrogen and phosphorus (common pollutant) 49
- nitrogen oxides (NO<sub>x</sub>) 266
- noise (environmental impact) 51
- non-biodegradable plastics 219, 236
- nonferrous metals 269–71
- nonmetallic minerals 13
- nonrenewables 310
- non-waste, waste versus 58–60, 113
- Norway 249
- Novo Nordisk plant, Denmark 334
- NO<sub>x</sub> (nitrogen oxides) 266
  
- odour (environmental impact) 51
- oil and gas industry 302
- oil-water separation 192
- online shops 312
- open-loop recycling 25, 220–1, 244, 252
- opportunity cost (regular goods) 59, 60, 143
- oranges 274
- ores 4–5
- organic compounds 200
- organic matter 205
- organic waste 247–50
- overly strict standards (supply chains) 329
- overproduction or overstocking (supply chains) 329

- overspecification (supply chains) 329
- oxidation processes 182–3, 196, 199, 209, 258, 276, 299
- oxidation-reduction potential (ORP) 183
- ozone depletion 46–7, 84–5
- packaging
  - excessive 329–30
  - food
    - audit 29–30
    - socio-technical systems 341, 342
    - systemic interactions 34
  - recycling 219–20
  - reusable 345
- paper
  - BOD wastewater 201
  - contaminated 33, 34, 173, 241
  - primary paper 238–9
  - production and manufacturing 240
  - recovery 181, 222
  - recycling 237–42
    - benefits and challenges 241–2
    - lifecycle 238
    - production and manufacturing 237–9
    - recycling process 239–41
    - separate collection 242
  - secondary paper 238–9
  - types of 239
  - wastepaper 239–41, 302
  - wood in production 237
- paper waste hierarchy (LCA) 79–81, 84–5, 86
- participation (consumption) 7
- particulate matter 47
- Pay-As-You-Throw (PAYT) taxes 158, 168–9
- pelletisation, plastic 219, 232, 233
- persistent organic pollutants (POPs) 50, 111
- personal and property rights (social impacts) 57
- person equivalents (PE) 84–5
- PET bottles, recycling 217, 220–1, 233, 234
- Philadelphia, US 120
- pH levels 50, 183, 269, 270–1, 291–2
- phosphorus removal, biological 202
- photochemical ozone formation 47, 84–5
- physical treatment 185–95
  - mixing 190
  - separation 191–5
  - size reduction 187–9
  - storage 185–7
  - technologies 191–2
- physicochemical treatment 195–199
  - gases 195
  - purpose and concept 195
  - solid wastes 198
  - technologies 178, 198–199
  - wastewaters 196–8
- planetary boundaries framework 43
- plasma gasification 209
- plasterboard 181, 334
- plastics
  - bioplastics 236–7, 278
  - cutlery 318
  - end-of-life vehicles 259
  - fossil-based plastics 236
  - lifecycle 231
  - liquid 219
  - non-biodegradable 219, 236
  - pelletisation 219, 232, 233
  - pollution
    - bags 132–3
    - drinking straws 156
    - ocean 48–9

- recovery 181
- recycling
  - benefits and challenges 235–7
  - production 231–3
  - recycling process 233–5
  - thermoplastics 232–3
- plate-and-frame filtration 192
- poisoning 106
- policies, waste prevention 158–9
- policy actors (policy process) 127
- policy and legislation 102–36, 110–18
  - definition of waste 112–14
  - drivers of waste management 104–9
    - environmental protection 108–9
    - overview 104–5
    - public health 107–8
    - resource value of waste 104, 105–6
  - exercises 111, 132
  - introduction 103–4
  - learning objectives 102
  - legal principles 117–18
  - major laws 110–11
  - making of policy 126–34
    - defining the problem 129–31
    - implementation and evaluation 133–4
    - policy design 131–3
    - policy process 126–8
  - policy instruments 118–26
    - economic instruments 124–6
    - information instruments 123–4
    - overview 118–19
    - regulatory instruments 119–20
    - voluntary instruments 121–2
  - review 136
  - summary 135
  - waste classification 114–17
  - waste legislation 110–18
    - definition of waste 112–14
    - legal principles 117–18
    - major waste laws 110–11
    - waste classification 114–17
- policy debates (policy process) 128
- policy integration 134
- political systems (social impacts) 57
- pollutants and hazards 49–52, 106–9, 195, 284, 289–2, 297–8
- polychlorinated dibenzofurans (PCDFs) 265–6
- polychlorinated dibenzo-p-dioxins (PCDDs) 265–6
- polyethylene terephthalate (PET) 232
- polymers 173, 183, 211, 232, 233, 234–5
- polypropylene (PE) 233, 287
- polystyrene (PS) 233
- polytetrafluoroethylene (PTFE) 266
- polyvinyl chloride (PVC) 233, 266, 287
- population growth 6, 45, 176
- positive consequences (impacts of waste) 39
- post-consumer recycling 219
- Power and interests (policy process) 128
- power stations 212, 257, 262
- precipitation process 198, 199
- pre-consumer recycling 219
- pre-consumer waste 239, 240
- pressures (DPSIR) 44–5
- pressure swing adsorption 281
- pretreatments, feedstock 275–6
- prevention, waste 138–62
  - achieving prevention
    - EPR scheme for textiles in France 160–1
  - extended producer responsibility (EPR) 159–60

- green engineering 157–8
- role of product design 157, 158, 229, 235, 245–7
- waste prevention policies 158–9
- efficient production and
  - manufacturing 144–9
- environmental benefits of lean manufacturing 148–9
- internal cycling 148
- light-weighting 144–5
- materials substitution 145–6
- phasing out lead-based paint 146, 153–4
- yield improvement 147
- efficient use 149–52
  - intensity of transport use 151–2
  - planned obsolescence 150–1
  - product longevity 149–50
  - product reuse 153
- exercises 141, 159
- hierarchy options 24–5
- introduction 139
- learning objectives 138
- overview 140–4
  - addresses cause of wastage 141
  - car use 143–4
  - concept of 140
  - economics of wastage 141–3
  - food sellers and wastage 142–3
  - types of prevention 143–4
  - why products become waste 140–1
- product avoidance 154–6
  - product substitution 154–5
  - service demand reduction 155–6
  - straws 156
- review 162
- summary 161
- prices (regular goods) 59
- price volatility (circular economy) 311
- primary processing 223, 229
- principles, legal 117–18
- private costs and benefits (CBA) 94
- problems, defining policy 129–31
- process energy 222
- processes (auditing) 28
- processes (MFA key concept) 68
- processing (product design) 325
- processing waste, global generation of 20
- process nonenergy emissions 222
- product avoidance 154–6
  - product substitution 154–5
  - service demand reduction 155–6
  - straws 156
- product category rules (PCR) 88
- product design
  - circular strategies 324–6
  - waste prevention and 157, 158, 229, 235, 245–7
- product improvement (LCA) 74
- production and manufacturing,
  - efficient 144–9
  - environmental benefits of lean manufacturing 148–9
  - internal cycling 148
  - light-weighting 144–5
  - materials substitution 145–6
  - phasing out lead-based paint 146, 153–4
  - yield improvement 147
- production (lifecycle stage) 11
- product lifetime (product design) 325
- product lifetimes (MFA key concept) 69
- products, efficient use and
  - waste prevention and 149–52
- products that are worth it (reverse logistics) 332
- provisioning functions (ecosystem services) 42



- proxies (data) 70
- public health 106, 107–8
- Public Health Act, UK (1875) 167
- pulp/pulping 238, 239–42
- pulpwood 79–80, 241–2
- pumps 174
- pyrolysis 209, 211–12, 213
  
- Queen Elizabeth Olympic Park 145
  
- RACER (circular economy indicators) 339
- rainwater 108, 269, 284, 289
- rebound effects (buying used smartphone) 323
- recovering (10 Rs) 317
- recovery *see* [energy recovery and disposal](#)
- recovery (hierarchy options) 24–5
- recovery (management system) 22–3
- recovery (systemic interactions) 34
- recyclability (product design) 325
- recyclable waste 16, 62
- recycled content (product design) 325
- recycling (10 Rs) 317
- recycling (business models) 327–8
- recycling (hierarchy options) 24–5
- recycling metrics 67, 221
- recycling regime (socio-technical) 340–1
- recycling–reuse transition 345
- recycling, waste 216–54
  - ‘drop-off’ sites 172
  - exercises 221, 247
  - household practices 168, 171–3
  - introduction 217–18
  - learning objectives 216
  - metal 224–30
    - benefits and challenges 228–30
    - metal production 224–6
    - recycling process 227–8
  - optimal level 229–30
  - other materials/products 242–53
    - complex products 245–7
    - low-grade recycling 250–3
    - organic waste 247–50
    - textiles, glass, cement 242–4
  - overview 218–24
    - benefits of recycling 222–3
    - concept of recycling 218–19
    - imperfect circle 224
    - measuring recycling 219–21
  - paper 237–42
    - benefits and challenges 241–2
    - lifecycle 238
    - production 237–9
    - recycling process 239–41
    - separate collection 242
  - plastics
    - benefits and challenges 235–7
    - production 231–3
    - recycling process 233–5
  - processes 179–81
  - recovery operation evaluation 251
  - review 254
  - summary 253–4
- reduce impacts (SIA) 92
- reduce, reuse, recycle 24, 106
- reducing (10 Rs) 317
- reduction process 196, 199
- refurbishing (10 Rs) 317
- refurbishing (business models) 327
- refuse-derived fuel (RDF) 62, 180, 212, 259
- refusing (10 Rs) 316
- regime change (socio-technical) 341–5
- regulating functions (ecosystem services) 42
- regulatory instruments 119–20
- relational value (nature) 42
- remanufacturing (10 Rs) 317

- remanufacturing (business models) 327
- renewable energy 62
- repair damage (SIA) 92
- repairing (10 Rs) 317
- repurposing (10 Rs) 317
- residual heat 259
- residual waste 16
- Resource Conservation and Recovery Act, US (RCRA) 110, 112
- resource depletion 47
- resource value of waste 104, 105–6
- response indicators (DPSIR) 44–5
- rethinking (10 Rs) 316
- reuse (business models) 327
- reuse, organic waste 247–50
- reusing (10 Rs) 317
- reverse logistics 332–3
- ride-hailing services 312
- risk assessment 173–4, 187, 285
- root causes of waste 140–1
- rotating biological contactor 201, 204
- rubber 186, 251–3, 326
  
- salts, soluble 291
- Samsung Galaxy Tab 4 tablet 245–6
- sand 314
- sandwiches, supply chain waste of 330
- screening process 191
- scrubber 195, 196, 266
- scrubbing process 199, 281
- seawater 291–2
- secondary feedstocks 219, 223, 230
- secondary processing 222, 229
- sectoral environmental accounts (EEIO) 96–7
- sectors, economy 96–8, 257–9
- sedimentation 192
- selective catalytic reduction (SCR) 266
- selective non-catalytic reduction (SNCR) 266
- Seoul, Republic of Korea 268
- separation, decontamination and 33
- separation processes 179–80, 191–5, 209–11, 219, 233, 269
- sewage odour 185
- sewage sludge 259, 302
- sewerage systems 108
- Shanghai, China 166
- sharing (business models) 327
- Shenzhen East Waste-to-Energy Plant 260
- silicon dioxide (SiO<sub>2</sub>) 281
- siloxanes 282
- single-use products 14
- siting, of landfills 285–6, 286
- size reduction 187–9
- skips 174
- slow and fast loops (material loops) 315–16
- sludge 16, 201, 202, 203–4, 207
- sludge aeration basin 201
- sludges, common (waste generation) 16
- slurry 178, 190, 195, 196, 237, 241, 266, 272, 274, 300
- smart bins 168–9
- smartphones 232, 247, 323
- Snow, John 107–8
- SO<sub>2</sub> (sulphur dioxide) 196, 281
- social and environmental impact assessment (SEIA) 93
- social equality (circular economy) 312
- social impact assessment (SIA) 90, 91–3
- social impacts of waste 53–8
  - categories of 57–8
  - inequality and waste 54–6
  - waste and social norms 53–4

- social norms, waste and 53–4
- society (circular economy) 311–14
- socio-technical systems 339–45
  - components and linkages 339–40
  - recycling regime 340–1
  - waste-to-landfill regime 340–1
- soil improver 250, 283
- solar panels (socio-technical systems) 341
- solid fraction, digestate 282–3
- solid waste 51, 112, 198–199, 205, 260–71
- Solid Waste Disposal Act, US (1965) 108
- solid waste incineration, municipal 260–71
  - ash management 269–71
  - combustion 262–3
  - energy recovery 263–4
  - flue gas cleaning 265–8
  - fuel delivery 262
  - overview 260–2
- Solid Waste Law, China (1995) 110, 113
- soluble salts 291
- solvent extraction 192
- solvents, waste 212, 259
- source reduction *see* prevention, waste
- source-separation, household waste 171–3, 218
- sources, waste (auditing) 28
- Spittelau incinerator, Vienna 268
- state indicators (DPSIR) 44–5
- static-pile composting 202, 205
- Statute of Cambridge (1388) 167
- steam 208, 210, 263–4, 281, 335
- steel
  - contaminated with copper 34, 35–6, 228
  - demolition waste 18
  - lifecycle of 225
  - material loops 314
  - plants 86
  - producing 223
  - scrap 181
- stirred-tank reactors (STRs) 181
- stock-and-flow problem (MFA) 74
- stock dynamics (data) 70
- Stockholm Convention on Persistent Organic Pollutants (2001) 111
- stocks, material 11–12
- stocks (MFA key concept) 69, 70
- Stoichiometry (data) 70
- storage, waste 185–7
- strategies, circular 324–36
  - business models 326–8
  - industrial symbiosis 333–6
  - levels of action 324
  - product design 324–6
  - reverse logistics 332–3
  - supply chains 329–31
- Stratospheric ozone depletion 47
- Stuart, Tristram 142, 331
- subdivision (LCA) 80
- substitution (regular goods) 59
- subtraction (LCA) 80
- successive loops (cascading) (material loops) 316
- Sudokwon Landfill, Republic of Korea 285
- sulphur dioxide (SO<sub>2</sub>) 196, 281
- supermarkets
  - recycling–reuse transition 345
  - waste 330–1
  - waste prevention 143
- supply and demand (regular goods) 58
- supply chains 329–31

- supporting functions (ecosystem services) 42
- surface impoundments 300
- sustainability and the environment 40–4, 248
- sustainability goals (circular economy) 308–14
  - circularity in brief 308–10
  - economy 311
  - environment 310
  - society 311–14
- Sustainable Development Goals (SDGs) 313–14
- sustainable yield 310
- Sweden 170–1
- Switzerland 221
- symbiosis, industrial 333–6
- system boundary (MFA key concept) 68, 77–8
- system expansion (LCA) 80
- systemic interactions 34–6
- system inertia 339–41
- tailings, mine 299
- taxation
  - landfill 125–6
  - Pay-As-You-Throw (PAYT) 158, 168–9
- techniques, best available (BAT) 176–8
- technological change 6
- temperature-based separations 209–11
- 10 Rs 316–18
- TerraCycle 333
- Tesla 341
- Texas, US 123–4, 286
- textiles
  - drop-off sites 172
  - EPR scheme for 160–1
  - fibres 221, 232
  - recycling 243–4
- thermal
  - desorption 208, 210
  - destruction 208–9, 211–13
  - drying 208, 209–10
  - oxidation 260
  - separation 208
  - treatment 208–13
    - purpose and concept 179, 208–9
    - technologies 208–9
  - temperature-based separations 209–11
  - thermal destruction of waste and contaminants 211–13
- thermophilic anaerobic digesters 277–8
- thermoplastics 232–3
- thermosets 232
- thickening process 183
- throwaway living 54
- timber 249–50
- Timberland 326
- time (auditing) 29
- time delay (CBA) 94
- time duration (policy process) 127
- torrefaction 209, 211–12, 213
- total organic carbon (TOC) 265–6
- toxic compounds 200
- toxic metals 50, 106, 112, 181, 183, 184, 270, 271, 299
- Toyota Production System (TPS) 148
- trace elements 270–1, 282
- transfer coefficients (MFA key concept) 69
- transition management 343–5
  - relevant factors 344
- transport emissions 222
- transport (management system) 22–3

- treatment and collection 164–215
- treatment and recovery (lifecycle stage) 11
- treatment (management system) 22–3
- treatment, waste 176–84
  - history and requirements 176–7
  - household systems 179–81
  - industrial systems 181–4
  - types of 178–9
- trickling filter 201, 204
- trommel 179, 191
- trucks 174
- trust (industrial symbiosis) 335
- types of waste 28, 258–9
- tyres, discarded 186, 251–3
  - end-of-life treatments 252–3
- unavoidable waste 16–17
- uncertainty and limitations (MFA) 71–3
- United Kingdom (UK)
  - air pollution control residues 270–1
  - landfill tax 125–6
  - London 107–8, 110, 145, 273–4
  - material footprint 98
  - waste classification 115–16
- United Nations (UN) 110, 313
- United States
  - AVAC system 171
  - EPA 108–9
  - landfills 105
  - Love Canal disposals 109
  - meat and dairy production 60
  - packaging recycling 219–20
  - relative emissions from recycling 222
  - steel recycling 86
  - stockpiling tyres 252
  - Texas 123–4, 286
  - waste collection businesses 166
  - waste laws 108, 110, 111, 112, 113, 116
- United States Environmental Protection Agency (US EPA) 14, 108–9, 220
- university campus, symbiosis on 336
- unpriced externalities 142
- unwanted material 30–2
- upcycling, limits and opportunities 320–1
- use (lifecycle stage) 11
- value creation (circular economy) 318–21
  - strategies 319
- vehicles, end-of-life 227, 246, 259
- vehicles, refuse collection 169–70, 227, 262
- vibrating screen 191
- Vienna, Austria 268
- VIGGA 326
- volatile organic compounds (VOCs) 50, 210
- Volkswagen 155
- voluntary instruments 121–2
- Wales 297–8
- washing process 198
- waste collection 166–75
  - household 167–71
  - industrial 173–5
  - infrastructure 166–7
  - source-separation of household waste 171–3, 218
- waste electrical and electronic equipment (WEEE) 172, 245–7, 333
- Waste Framework Directive, EU (WFD) 52, 110, 113–14, 176
- waste outputs (material flow indicator) 337
- wastepaper 25, 34, 81, 223, 239–41, 302

- waste-pickers 55–6
- waste prevention *see* prevention, waste
- waste-to-landfill regime (socio-technical) 340–1
- waste versus non-waste 58–60
- wastewaters
  - metal-finishing 181–4
  - municipal 291–2
  - treatment of 196–8, 201–2, 203–5, 285
- water pollution 285
- water table 285
- water treatment 186, 285
- water vaporisation 27, 258, 264
- way of life (social impacts) 57
- wellbeing (circular economy) 311–12
- well networks 288, 293
- Wessex Water, Avonmouth 185
- ‘wet’ materials 173
- windrow composting 202, 205
- wood
  - in paper production 237
  - timber 249–50
  - waste 186, 212, 213, 247–8, 259
- woody plants 274
- yield improvement 147
- Yingchun landfill, China 95
- ‘zero-burden’ approach 76–7
- zigzag process 193



This introductory textbook provides an essential interdisciplinary guide to waste management and circular economy. It helps students to understand the drivers of waste, the environmental, social, and economic impacts of waste generation, and best practices and technologies for waste management, recycling, energy recovery and disposal.

With helpful, full-colour diagrams throughout, each chapter includes learning objectives, introduction to concepts and themes, exercises and review sections, to guide students through the book.

The textbook is ideal for teaching environmental engineering and science, as well as interdisciplinary environmental programmes.

**Stijn van Ewijk** is Lecturer in Environmental Engineering at UCL. He has a PhD in Sustainable Resources and Engineering from the UCL Institute for Sustainable Resources and was a Postdoctoral Associate at the Center for Industrial Ecology at Yale University.

**Julia Stegemann** is Professor of Environmental Engineering at UCL. She has more than thirty years of experience with waste management and resource efficiency and is Director of the Interdisciplinary Circular Economy Centre for Mineral-based Construction Materials.

 Free open access  
version available from  
[www.uclpress.co.uk](http://www.uclpress.co.uk)

 **UCLPRESS**

Cover images:  
Jirik V/Shutterstock  
FooTao/Shutterstock  
Joanne Dale/Shutterstock  
JOEYSTUDIO/Shutterstock  
Desiart/Shutterstock

Cover design:  
EMC Design Ltd

